

Making a Wheatstone Bridge

Ingenuity can often substitute when test gear isn't available.

J.N.M. LEGATE

Now that reasonably priced instruments with ohmmeter scales are readily available, the Wheatstone Bridge is rarely mentioned as a tool for measurement of resistance. However, my own experience of measuring anything other than medium values on an old analogue meter, particularly when coping with battery drift on low resistance and the difficulty of accurately reading high values on the non-linear scale, made me wonder if I could rig up a Wheatstone Bridge assembly to give reasonable accuracy over a fairly wide range of values without costing a lot. Perhaps a digital instrument would be a better answer, but I haven't got one and cannot really justify the expense for quite limited usage.

The principle of the bridge is quite straightforward, the basic circuit being shown in Fig. 1. R1 and R2 are the "ratio arms", R3 the "measurement arm", and Rx the unknown value to be measured. When the ratio and measurement arms are set to give zero deflection on the sensitive meter, the value of Rx is $(R2 \times R3)/R1$. Accuracy is entirely dependent on the accuracy of the resistances and the sensitivity of the instrument, and meter accuracy is not significant.

There used to be two versions of the commercially available bridges, both using high precision noninductive resistors from 1

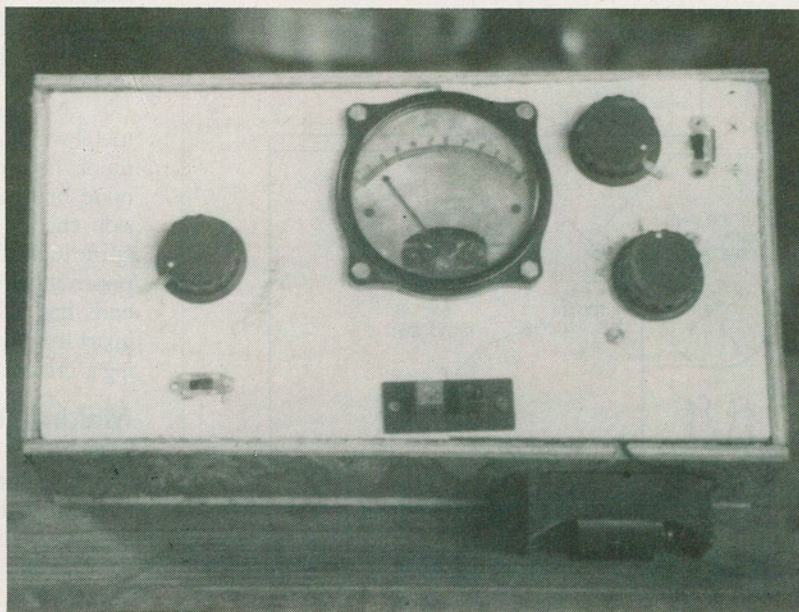

to 5 or 10 thousand ohms, either in steps of 1,2,2,5 units, tens hundreds and thousands, or 1-10 in units, tens, etc, selected by a system of accurately machined low contact resistance brass plugs, the whole arrangement being well beyond my capabilities of copying, so I gave some thought to alternative possibilities.

Binary Switching

A binary system of switching seemed to be a suitable starting point, as 1, 2, 4, 8 values would give 15 unitary steps from 1 to 15, so using 100 ohm units would give 100 to 1500 ohms in 100 ohm steps and the 100 ohm gap could be filled by a variable unit. Similarly, if R2 was made 100 ohms and R1 selectable at 100, 1k, 10k and 100k, ratios of 1 to 100 would be obtainable, and interchanging the ratio arms would extend

ratios down to 1/100, all without requiring large numbers of units. Moreover, Radio Shack has a kit of 50 metal film resistors, 1%, from 10 to 1M values that seemed to cover requirements. However, the method of binary switching was not immediately obvious. A four deck rotary switch with 10 or more positions was a possibility, but apart from not being able to find one, I was not happy that durability and convenience of operation would be satisfactory, so eventually I managed to concoct a somewhat unorthodox device that worked.

The heart of the gadget was a "camshaft" to operate four roller lever microswitches (also Radio Shack). A wooden cotton reel was used for convenience, as it already had a centred hole to take a bit of 1/4" dowel rod as a spindle. The cams were made up from 1/16" aluminum strip. No doubt the sizes could be derived by measuring the reel diameter and calculating lengths, but I took the easy way by putting a piece of masking tape round the reel, marking the length and then removing the tape and marking out the sixteen equal divisions. It was then quite easy to stick the marked tape on to a piece of aluminum sheet and cut the various "cams" from this pattern.

In practice I found it best to cut 1/4" wide strips, bend them round a broom handle until they were more or less to the

Making a Wheatstone Bridge

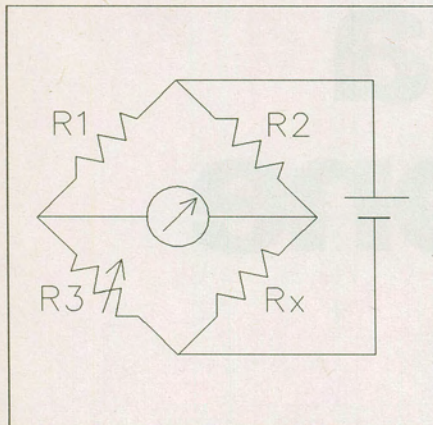

Fig. 1. The basic bridge. When the bridge is balanced, there will be zero volts across the meter. If $R2$ is 10 times $R1$, the ratio is 10, and if the arms are interchanged the ratio is 0.1.

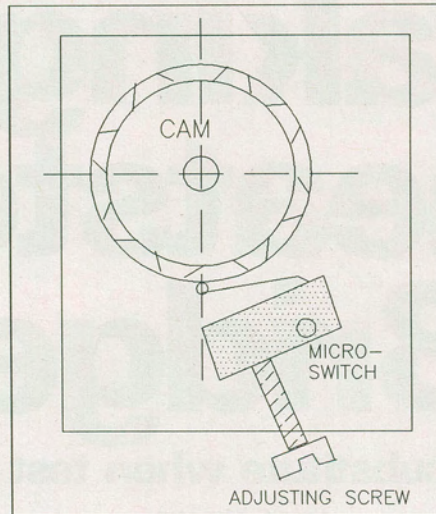

Fig. 2. The cam switch mounting.

curve of the reel surface, and then cut to length, as this ensured that the strips lay reasonably accurately on the reel. I drilled small holes to take brads for securing the strips to the reel, but epoxy or Crazy Glue would probably give a perfectly satisfactory bond. The end of each strip should be filed to approximately 45° to prevent stubbing of the roller levers.

Final assembly turned out to be more complicated than I had expected. It proved to be unsatisfactory to use the two mounting holes in the lever switches, as minor inaccuracies in the cam heights together with the imprecise operating points of the switches would not permit rigid mounting, and I ended up by pivoting the switches on one mounting hole and setting their individual positions by trial and error with screw adjusted stops as indicated in Fig. 2. As space was rather tight I used Loctite rather than locknuts to secure the screws.

No doubt anyone with reasonable metalworking facilities could make up a much better mechanical assembly than mine, but the arrangement of $1/4$ " wooden side cheeks drilled to take the camshaft spindle and switch support (a scrap poprivet wire) held by bent sheet metal ends has held together so far. However, apart from the switch setting screws, nothing is critical.

Making R3

There was a certain amount of improvisation in getting the exact values of resistance steps; I concocted these as indicated in Fig. 3, since the resistor kit did not provide all the required units. Consequently, the nominal 400 ohm step was theoretically 399.95 and the nominal 800 ohm step 801.5, both well inside the 1% nominal accuracy of the resistors. In fact, if I hadn't been feeling rather niggardly, a second kit of resistors would have reduced the amount of fiddling.

The only remaining point of importance was then the means of indication, and there is quite a lot of scope for alternatives. My approach was to assume that it is possible to detect about one thousandth of full scale of an instrument, so that one microamp is visible on a 2" scale millimeter, or .05 microamps on a 50 microamp movement, although this may be stretching things somewhat. The instrument deflection is defined by the out-of-balance voltage across it and the internal resistance of the instrument. As a 1mA movement is perhaps between 10 and 100 Ohms, and a 50 microamp movement be-

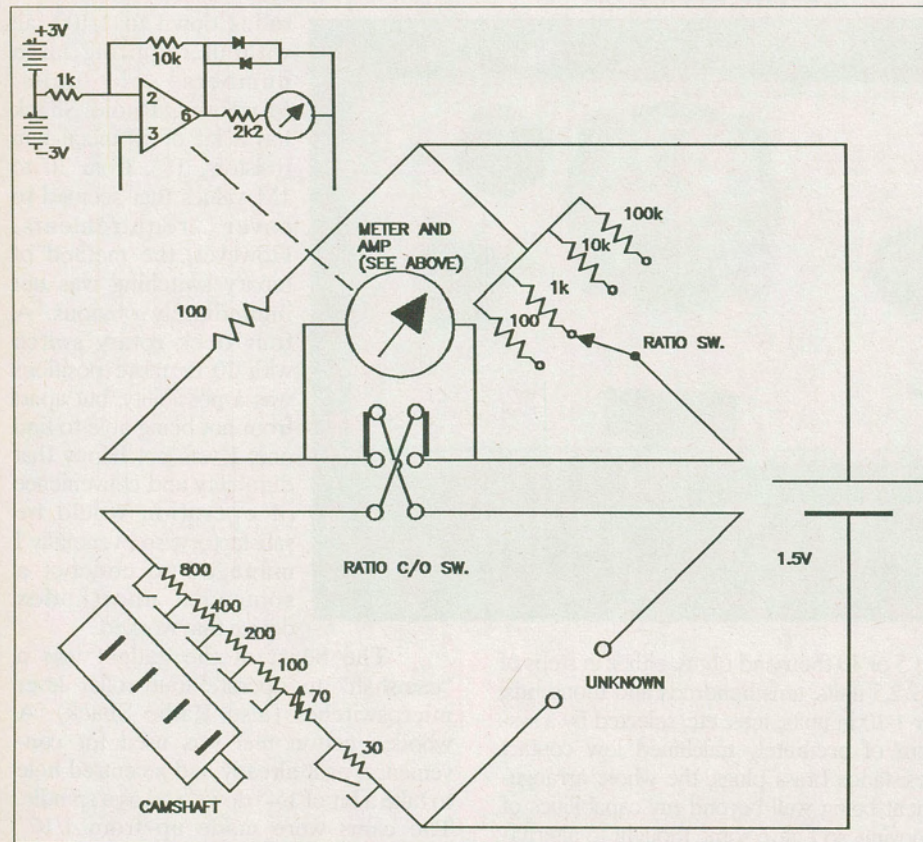

Fig. 1a. The bridge circuit as actually used.

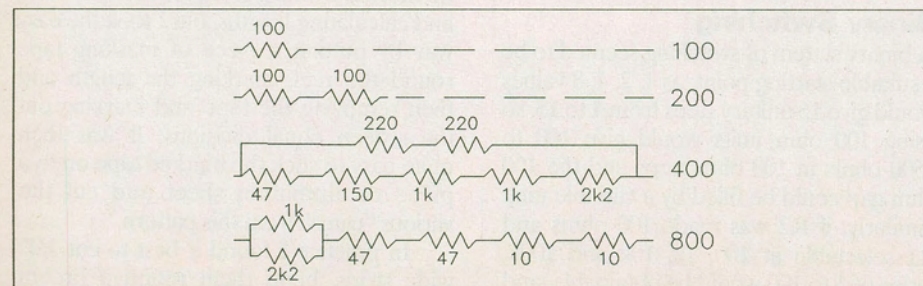

Fig. 3. Making up R3 with various resistor combinations.

tween 1 and 2k typically, a 1% error in setting the measuring arm would give about 1.25 mV across the instrument when measuring a nominal 1 megohm value, or about 150 microvolts when measuring a nominal 1 ohm with a 1.5V battery on the bridge. So detection might be possible by direct readings, but such small movements would be rather difficult to work with. I inserted a 741 op amp, with moderate gain, to step up the sensitivity.

tally, it is most essential to have some protection for the instrument to avoid wild overswinging when well off balance, and even when near balance to cater for the indeterminate situations between steps due to the inherent inaccuracies of cam positions and the somewhat uncertain points of operation of the quick action microswitches. The back-to-back diode system is perfectly adequate, bearing in mind that no more than about .7V appears across silicon diodes, or about .3V with germanium units. The base/emitter or base/collector connection in transistors could be used, if you make sure you get the polarities right. Instruments can usually take quite heavy overloads for short

periods and limiting the current to about twice full scale will not cause damage if the needle hits the end stops, so the series resistance can be of a value such that the total resistance across the diodes — i.e. coil plus external resistance — only passes about twice full scale current with .7 or .3 volts. Some trial and error may be required to get an acceptable performance.

The physical arrangement of the bridge is a matter of personal preference. The variable resistance I used was far too big and was actually a 70-ohm field rheostat about 50 years old that was wound in three grades of wire, so that the scale was by no means linear, but was capable of being calibrated reasonably. The missing 30 Ohms was inserted to extend the value when necessary — a rather crude set up that would be greatly improved by using a 100 ohm linear potentiometer. You will by now have realized that my arrangement was a long way from an ideal one, but in practice it turned out to do all I wanted, cost very little, and was an entertaining exercise to try out.

No doubt there is very limited use for such a scheme, but I hadn't seen the idea

of a camshaft switching method of selecting a binary sequence and it seemed that it might be useful not only for this bridge scheme, but possibly for other requirements, and it would of course be quite possible to add extra stages, probably with a bigger camshaft. For example, one extra cam and switch covering 32 steps would give 31 unit steps, but it would almost certainly require at least a 2" diameter for the camshaft. Incidentally, the micro switches have normally-open and normally-closed contacts, so either clockwise or anticlockwise rotation can increase the resistance value. Thus you could have a fixed scale on the panel or the knob depending on preference.

As I had made no attempt to get a professional arrangement I have not gone into much detail of construction, but have given some idea on improvising a useable system. I used a small piece of Veroboard to mount the string of resistors, though it would be more elegant to produce a printed circuit to carry the resistors and the op amp details, and panel layout is very much a matter of personal preference. ■

THE NEW 65/9028 VT ANSI VIDEO TERMINAL BOARD!

★ FROM LINGER ENTERPRISES ★

A second generation, low cost, high performance, mini sized, single board for making your own RS232 Video Terminal. This highly versatile board can be used as a stand alone video terminal, or without a keyboard, as a video console. VT100, VT52 Compatible.

FEATURES:

- ★ Uses the new CRT9128 Video Controller driven by a 6502A CPU
- ★ On-Screen Non-Volatile Configuration
- ★ 10 Terminal Modes: ANSI, H19, ADM-5, WYSE 50, TVI-920, KT-7, HAZ-1500, ADDS 60, QUME-101, and Datapoint 8200
- ★ Supports IBM PC/XT, and Parallel ASCII Keyboards
- ★ Supports standard 15.75 kHz (Horiz.)
- ★ Composite or Split Video (50/60 Hz)
- ★ 25 X 80 Format with Non-Scrolling User Row
- ★ Jump or Smooth Scroll
- ★ RS-232 at 16 Baud Rates from 50 to 19,200
- ★ On Board Printer Port
- ★ Wide and Thin Line Graphics
- ★ Normal and Reverse Screen Attributes
- ★ Cumulative Character Attributes: De-Inten, Reverse, Underline and Blank
- ★ 10 Programmable Function Keys and Answerback message
- ★ 5 X 8 Character Matrix or 7 X 9 for IBM Monitors
- ★ Mini Size: 6.5 X 5 inches
- ★ Low Power: 5VDC @ .7A, ± 12VDC @ 20mA.

MICRO SIZE!

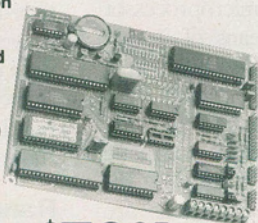

\$79⁹⁵
FULL KIT
w/100 Page Manual
ADD \$40 FOR A&T

OPTIONAL EPROM FOR
PC/XT STYLE SERIAL
KEYBOARD: \$15

SOURCE DISKETTE:
PC/XT FORMAT
5 1/4 IN. \$15

Digital Research Computers

P.O. BOX 381450 • DUNCANVILLE, TX 75138 • (214) 225-2309

Call or write for a free catalog on Z-80 or 6809 Single Board Computers, SS-50 Boards, and other S-100 products.

TERMS: Add \$3.00 postage. We pay balance. Orders under \$15 add 75¢ handling. No C.O.D. We accept Visa and MasterCard. Texas Res. add 6-1/4% Tax. Foreign orders (except Canada) add 20% P & H. Orders over \$50 add 85¢ for insurance.

Circle No. 10 on Reader Service Card

More meter for your money!



HC-5010EC MULTITESTER

Basic accuracy 0.1%/0.25%; Buzzer for continuity check; Temp. to 1300°C; Conductance and capacitance; TR gain; Ten AC/DC volt ranges plus current and resistance.

\$109.50

Plus \$5 for shipping & handling.
Carrying case: Add \$10.

MODEL HC-775

Autorange digital multimeter with 5 DC voltage ranges, 200mV to 1000 VDC, 4 AC voltage ranges, 2V to 750VAC plus AC/DC current and resistance 0.1 ohm to 2 Meg. ohm. Max. 10 amp overload protection.

\$74.50

Plus \$5 for shipping & handling.
Carrying case: Add \$10.

VALUE PLUS!

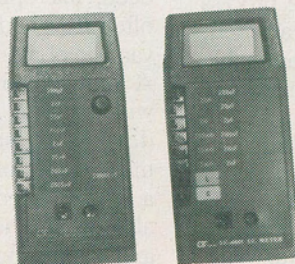

CAPACITANCE METER

MODEL DM 6023

Features nine capacitance ranges from 0.1pF to 20,000uF. .5% accuracy. Supplied with 9V battery, test clips and spare fuse.

\$109.50

Plus \$5 shipping & handling.
Carrying case: Add \$10.

LC METER

MODEL LC 6043

Five inductance ranges from 1uH to 20H. Six capacitance ranges from 1pF to 200uF. 1% accuracy. Supplied with 9V battery, test clips and spare fuse.

\$149.50

Plus \$5 for shipping & handling.
Carrying case: Add \$10.



Order by phone or mail. Credit card, money order, cert. cheque or C.O.D.
Ontario residents add 7% P.S.T.



KB ELECTRONICS

355 Iroquois Shore Road, Oakville, Ontario L6H 1M3
Tel: (416) 842-6888 • Telex: 06-982396 KBELQV

Circle No. 11 on Reader Service Card