

Tips for Coil users

Part 1

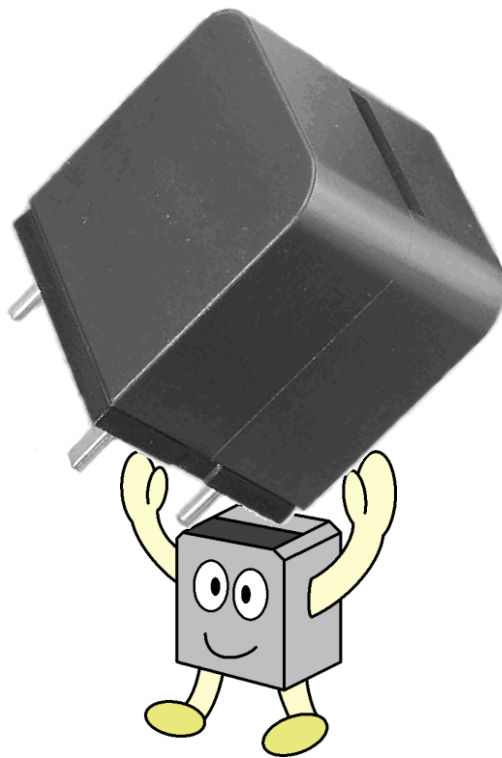

SAGAMI ELEC CO., LTD.

<https://www.sagami-elec.co.jp/en/>

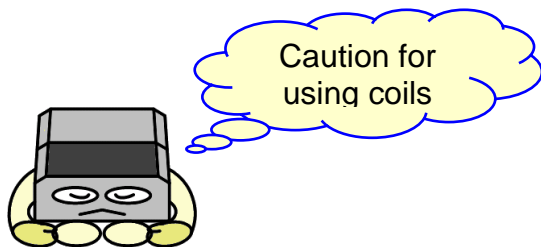

【 Cautions for Storage and Handling 】

- Do not store products in the areas with conditions such as high temperature, humidity, dust, and corrosive gas that may affect the products to deteriorate.
- Handle with care to avoid dropping and loading without containers that may cause breakage.
- Do not touch electrodes of products without protective glove to avoid deterioration of solder.

【 Cautions before Use 】

- Do not bend terminal pins to avoid wire breakage from an excess stress.
- Do not cut off terminal pins to avoid wire breakage.
- Fix all terminal pins and case lugs with solder on PCB.
- Do not fix tuning slugs and/or cores of variable coils with solder flux.
- Do not rinse coils. When rinsing is necessary, consult with our local Sales office.
- Possibly avoid fixing coils on the edge of PCB.
- Coils are designed for automatic insertion. Take extreme caution when soldering manually.
- Follow the soldering specification when using reflow soldering for SMD coils.

Index

(1) A difference between coils and inductors	3
(2) Parameters of a coil (electrical specifications)	5
(3) Inductance of coils	8
(4) inductors and heat generation	10
(5) Q of coils	12
(6) Self resonance frequency of inductor	15
(7) Open magnetic and shielded	18
(8) Eddy current and magnetic shield	21
(9) Temperature characteristic and insulation characteristic	24
(10) The operation (performance) of coils	27
(11) Coupling between coils	30
(12) Tips when you use a coil	33

Notes

1. Some of the products described in this text are already discontinued.
2. Since some time has passed since the article was written, the information contained therein is still old.

Tips for COIL users (1)

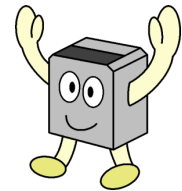

Introduction

We often hear that "Coil is very difficult to understand in electrical components". Indeed, even we, coil manufacturer, also feel the coils are complicated compared with other passive components, resistors (R) or capacitors (C). So, from a viewpoint of the coil manufacturer we are going to serialize the "Tips for Coil users" to encourage you to understand and use coils more. The schedule is total of 12 times biweekly. We hope this helps to all of the coil users.

What is a difference between coils and inductors.

We SAGAMI call components with a wire wound up in spiral "coils". Among them, the coils that have single winding are identified as "inductors".

However, we also call "products that has two or more inductors in structure" "inductors". When we describe in figure, coils include inductors, transformers, filters and others as Figure 2. There are no particular rules in the industry but such names as "Inductive components", "Transformers" or "Inductors" are used in the international standards (IEC), rather than coils. Of course, it is all right to call inductors coils. For your information, if we are asked a nature of business, we would answer "we are coil manufacturer!"

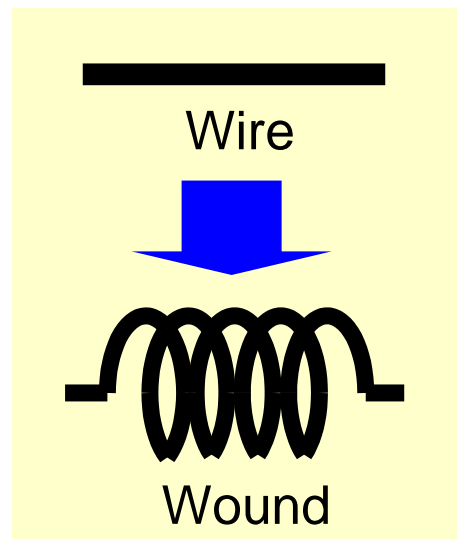

Fig. 1

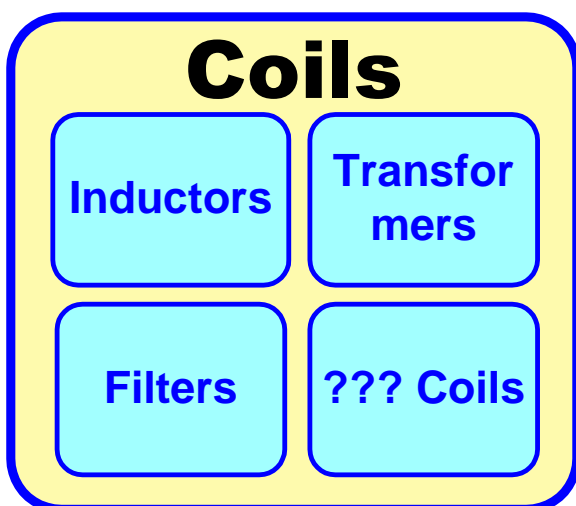

Fig. 2

When you request samples, please do not hesitate to tell us just "COILS". Then we can absolutely understand your request.

For your reference, coils are described in JIS C5602 "Glossary of Passive Components for Electronic Equipment" that "coil: in general, a component which has a structure of a conductor wound around an insulator, and has a self-inductance".

Why do coils have different names though they have similar appearance?

Like other components, some product names come from their "materials", and some come from "electrical characteristics" or "applications". Most of capacitors are called after their "materials", while coils are called after both of them.

In the most cases, the materials used for capacitors are related to the applications while it is not necessarily the case for coils. Even when it is called as an "inductors for xxxx", it is very rare case that it must be used only for the particular application. Especially in the case of a coil optimized for its particular application, we may call it a "coils for xxxx" to emphasize the application and appeal it to our customers. Conversely, we may use "coils for xxxx" designated by our customers as the components name.

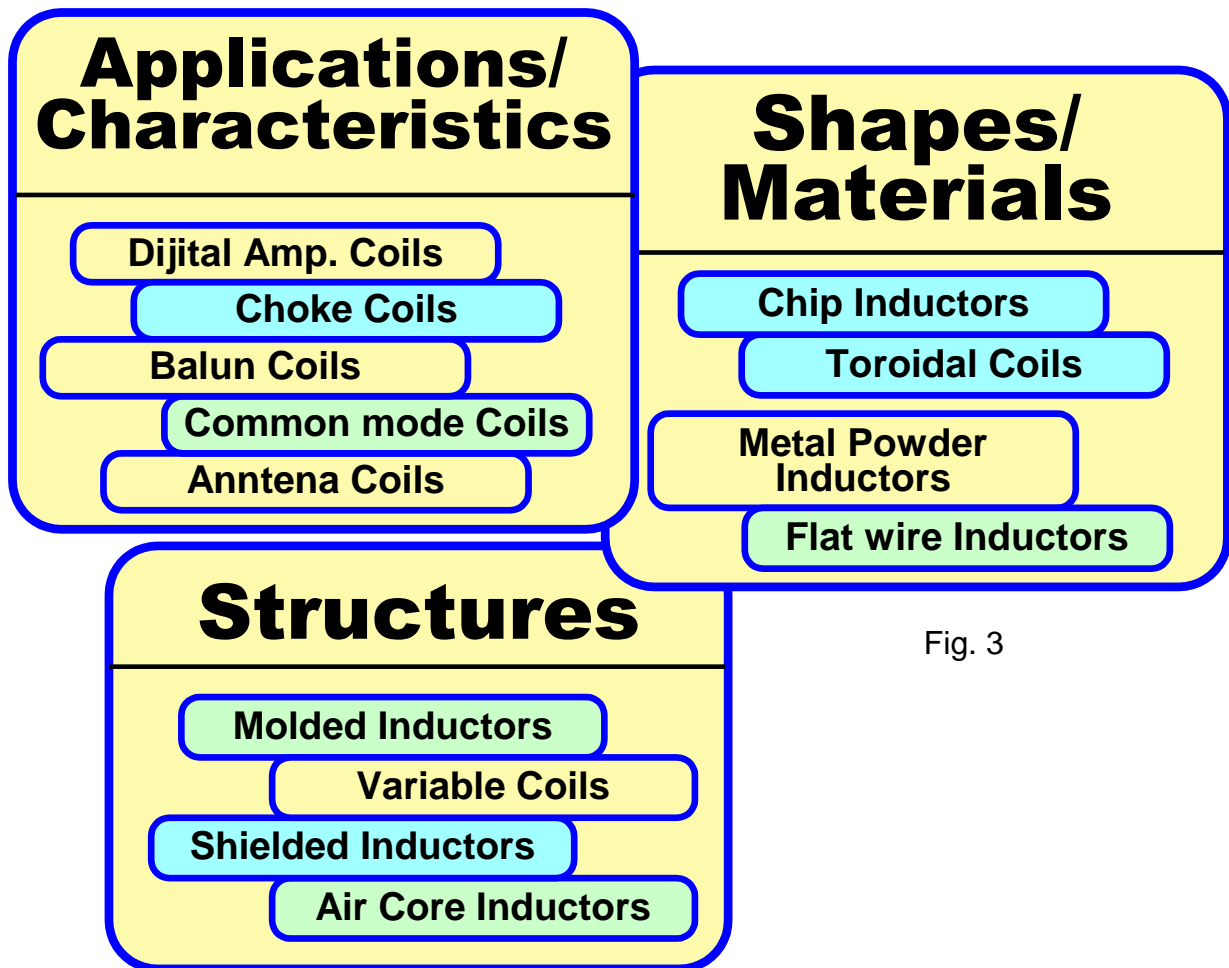

Fig. 3

We understand that it is difficult to identify coils because each company has different forms and names of them.

Please just refer to the specifications of coils regardless of their name.

If characteristics meet your requirements, it could be used for your request.

Please feel free to contact us whenever you need us.

Y.Hoshino

Tips for COIL users (2)

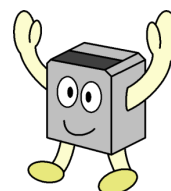

● Introduction

Following the first issue, the second topic is about "**parameters of a coil (electrical specifications)**". We'll focus mainly on inductors (fixed coils) for a while.

● Parameters (factors) to define specifications of an inductor

Major parameters of an inductor include, but not limited to, followings, and required parameters depend on an application. Our catalog provides only essential parameters for an application that we assume.

- | | |
|-----------------------------|--|
| ① Inductance: | Essential |
| ② DC Resistance: | Essential to inductors for power supply |
| ③ DC superposition current: | Essential to inductors for power supply |
| ④ Allowable current: | Essential to an inductor for power supply |
| ⑤ Q: | Often used in inductors for high frequency |
| ⑥ Self resonance frequency: | Often used in inductors for high frequency |
| ⑦ Impedance: | Often used in particular inductors |
| ⑧ Temperature rising: | Essential to inductors for power supply |

● Summary of each parameter

"An ideal inductor" may have following characteristics;

- The inductance is stable
- The loss is zero (DC resistance is zero, Q is infinity ∞)
- Unlimited current can be supplied
- Zero temperature rise
- The self resonance frequency is infinity ∞

However, these characteristics are only in a theoretical circuitry or simulation. In fact, the all values for inductors are all finite. To identify differences from the ideal inductor, various parameters are applied.

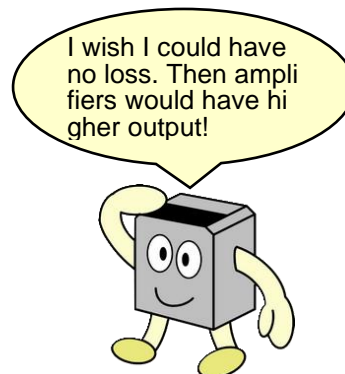

1. Inductance:

Represents an electrical value of inductance, and its unit is H (Henry).
Practically, μH (micro Henry: $\times 10^{-6}$) or mH (milli Henry: $\times 10^{-3}$) is often used.

2. DC resistance:

It is equivalent to resistance of windings (copper wire). The smaller resistance is, the less loss becomes.

It is an important parameter for the application of power circuit.

3. DC saturation allowable current:

When the direct current is supplied to the inductor, inductance decreases. It represents a point that inductance begins to decrease. The decreased inductance returns to the normal value when the current becomes small.

4. Temperature rise allowable current:

Represents a maximum current which can be applied to the inductor based on the heat generation of the inductor. If the current is supplied exceeding spec, the inductor may be damaged. Use conditions are limited depending on the current, because the inductor is a current-fed device.

5. Q:

Represents an inductor performance at specified frequency by following formula as an index.

It has no unit because it is an absolute number.

$$Q = \omega L / r \quad r : r \text{ is resistance which represents losses in its frequency.}$$

6. Self-resonance frequency:

Small amount of stray capacitance exist in an inductor. The inductor resonates by stray capacitance and inductance. It represents the frequency when this occurs.

7. Impedance:

To represent impedance at specified frequency. This is used in special case.

● **Current specification of inductors**

We would like to explain about current specification, which is one of the most complicated specifications. There are two main types of current specifications:

- ① If the (DC) current is supplied exceeding spec, the heat generation will damage the inductor.
>> It is generally called " Temperature rise allowable current".
- ② If the (DC) current is supplied exceeding spec, the heat generation does not damage the inductor but causes the inductance reduction.
>> It is generally called "DC saturation allowable current".

There is a case that smaller one of 1 or 2 is specified as "Allowable current".

We would appreciate if you could take a closer look at current specification while checking required characteristics.

There are two types of characteristics, one is low heat generation (A : continuous line) and the other is high saturation current (B : dotted line). Please refer to the figure on the right side.

In the case of DC/DC power supply, the inductor with the characteristic (A) (standard inductor) is used generally, because the current flows continuously in most case.

For digital amplifier, which is popular in the market recently, mostly the large current flows momentarily. So, the characteristic (B) may be used, that is not saturated at peak current rather than heat generation.

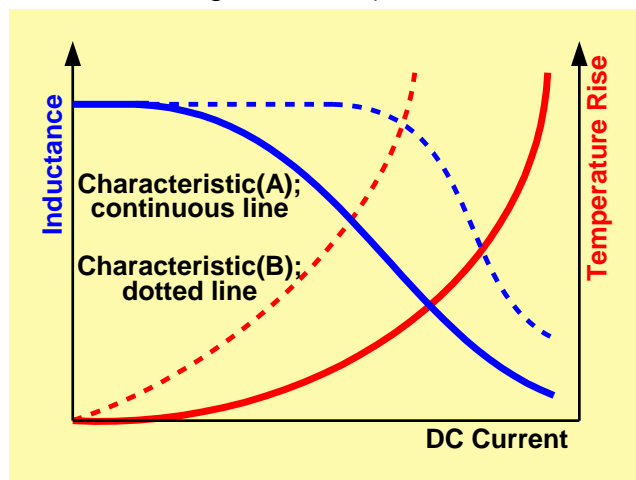

Graph-1

For a reference, we are showing an example of the characteristics of "7G17D", which is for a digital amplifier.



Type	Inductance (μH)	DC saturation current (A)	Temperature rise current (A)
7G17D-100M	10 ± 20%	26.0	8.2
7G17D-220M	22 ± 20%	13.0	8.2
7G17D-330M	33 ± 20%	7.5	8.2

*Please take a look at the differences of current specifications.

In addition, regarding the characteristics of the DC saturation allowable current, some products have a sharp reduction curve of inductance, some have a gentle curve of inductance (due to differences of construction/material). Therefore, please also take these characteristics into consideration according to your application when choosing the inductor.

● **How to select the inductor**

Inductor is electronic component, so above "electrical parameters" are to be fixed first. Also, the inductor is to be selected in consideration of conditions such as form, construction and use environment. We can provide documents of characteristics that are not on the specification, please feel free to contact us.

● **DC superposition characteristic (saturation of inductance)**

Although we can make a coil by only winding wire (this is so called "air core coil"), we usually use the combination of magnetic materials to decrease the size. When the "air core coil" is combined with the ferrite core that is one of magnetic materials, the inductance can increase several times to several hundreds of times.

However, the magnetic materials have the characteristic of magnetic saturation. When the magnetic saturation occurs, it decreases the effect of enhancing inductance. As the result, the inductance of the coil decreases.

Generally, among coils with the same inductance, magnetic saturation occurs quickly in smaller form, which leads to the drastic decrease of DC superposition current (less current is supplied). Nevertheless, material improvements enabled us to reduce an inductor size.

Y.Hoshino

Tips for COIL users (3)



● Introduction

This third topic is about "**Inductance of coils**". You might think that each topic is not linked that much, but we hope this could help your understanding of the coils.

● Inductance of wound coils

In the first topic, the coils are described as the components with wire wound up in spiral. Then, the relationship between the inductance (L) of coils and the winding turns (N) is as below (The inductance is proportional to the square of winding turns (N)).

$$L = k \times \mu e \times N^2 \quad (\text{H: Henry})$$

k : Constant value depending on a form and so on
μe: Effective permeability

For the wound coils, when the winding turns become double, the inductance becomes quadruple. In the recent case of low inductance coils, if the winding turns changes 1T, the inductance will significantly change. Because their winding turns is small and must only be integer.

For example, the table-1 shows each inductance per turns when the inductor has 5T and 4.7uH. In this case, we can't build the inductance with the center value of 10.0uH.

For other examples, the inductance is 6.8uH at 11Ts in the case of CER8042B (Photo-1).

Some engineers of set maker know the formula above, and may request like this: "Please decrease one turn to achieve inductance XXuH!".

Table-1

Winding Turns(N)	Inductance(L)
5T	4.7uH
6T	6.8uH
7T	9.2uH
8T	12.0uH



Photo-1 CER8042B

When developing inductors, we usually struggle and fix the forms to meet the turns and the inductance according to E6 or E12 series.

For the wound inductors, it is possible to set the customized inductance=(by changing the turns). However, some cases can never be achieved depending on inductance value.

● Effective permeability

Even though magnetic materials are added to an air core coil, the actual inductance won't increase in multiples of material permeability. This is because not all of the magnetic flux generated from the coil passes through the magnetic materials. Then there is a standard named effective permeability as the scaling factor of the actual inductance value from the air core coil.

If any air gaps exist in the magnetic circuits, the effective permeability will significantly decrease. For this reason, even though very high permeability material is used, the effective permeability will not so much increase.

Therefore, there is a limitation of the downsizing of inductor by using materials with high permeability.

● **Core Gap**

All values of temperature rise allowable current were same concerning the 7G17D specification (Table-2) shown in the former issue. That's because the DC resistance was same. In fact if the DC resistance is same, the windings inside the coil are all the same.

Table-2

Type	Inductance (μ H)	DC saturation current (A)	Temperature rise current (A)
7G17D-100M	10 \pm 20%	26.0	8.2
7G17D-220M	22 \pm 20%	13.0	8.2
7G17D-330M	33 \pm 20%	7.5	8.2

Then, do you know how we can change the inductance?

The answer is by changing μ_e (effective permeability) without changing the form or turns of inductors.

Actually we provide the gap (slit: Fig-1) to a part of ferrite core of the magnetic materials. The gap contributes to change the effective permeability (apparent magnetic characteristics) without changing the materials of ferrite core.

However, the gap size affects not only the inductance but also the DC saturation allowable current characteristics.

The relationship among the gap size, inductance, and DC saturation allowable current characteristic is as the graph-1 below.

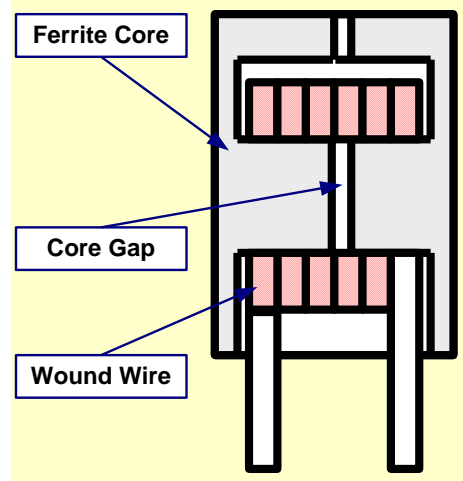
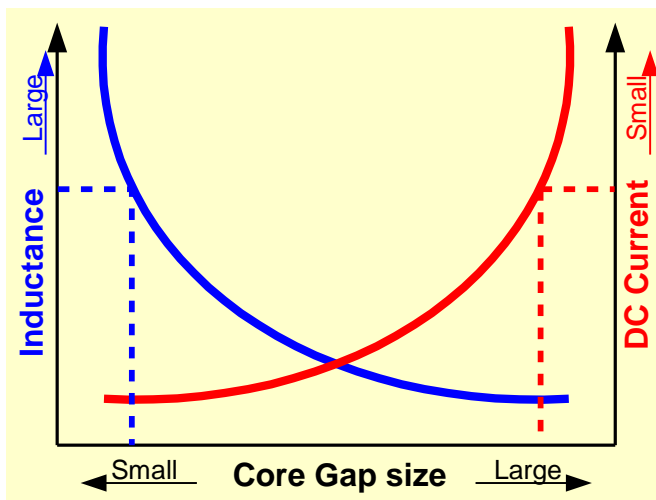

Fig-1 Cross section of 7G type

The gap size will be determined in view of both balances. Please look at the table-2 again. You can find the table-2 is like the graph-1. (If inductance is large the gap is small.)



Graph-1 Core Gap characteristic

"To decrease the loss, we have to decrease turns of wire for low resistance and narrow the gap for increasing inductance. But, the DC saturation allowable current characteristic will decrease... What a dilemma!"

Then, it is a good opportunity for us, coil manufacturer, to show our strength how the gap is designed and set at which part of the inductor to achieve the best characteristics.

Y.Hoshino
April 10,2009

Tips for COIL users (4)



● Introduction

The fourth topic is about "**inductors and heat generation**". A lot of electronic components have specifications of allowable current value due to the limitation of the heat generation. Coils are subjected to the limitation as well.

● What is the problem with heat generation?

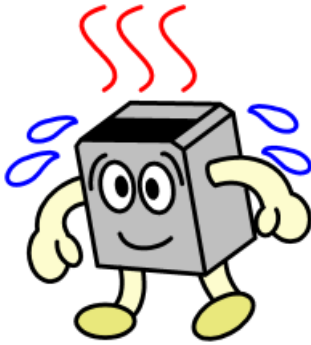

First, the heat generation deteriorates the resin coating of wire which is used for coils, and increases the possibility to short-circuit the coils. (In general, heatproof temperature classification is; **class E: 120 deg.C**, **class F: 155 deg.C**, and **class H: 180 deg.C**.) In addition, the coils using adhesive have high possibility to be damaged by deteriorated adhesive.

Second, when exceeding the curie temperature of the ferrite core (normally not less than 200 deg.C for power inductors), the magnetic characteristic will be lost and the inductance will dramatically decrease. (Such situation will become normal when the temperature decreases.)

Like the other general electronic components, if the coils are subjected to high temperature for a long time, deterioration will be accelerated. (It is not so fast like electrolytic capacitors.) Therefore, please avoid temperature rising too high. At worst, there may be the case like "the temperature rose too high, which led the solder which fixes the coil melted away, and the coil was dropped from the board".

● Causes of heat generation of the coil

In case of wire-wound coil, when DC is supplied to the coil, the heat is generated by the loss due to resistance of the wire. By contrast, when AC is supplied to, other losses are also generated (by skin effect and loss of the magnetic materials), which leads to the heat generation.

When an equivalent circuit of coils is represented as $LS + RS$, the frequency characteristic of our power inductor (**CER1277B-101**) is as **Graph-1**. We can find almost same trend for the inductors made of ferrite core.

When supplying the current containing AC, it is necessary to consider the loss of AC (high frequency) as well as DC. However the heat generation is proportional to the loss (=current squared). If the ratio of DC and AC is **10:1**, the heat generation of DC and AC is calculated to be equal when the **Rs** is **100 times** bigger.

If the heat generation is unexpectedly large, it may be necessary to check the current waveform supplying to the coil.

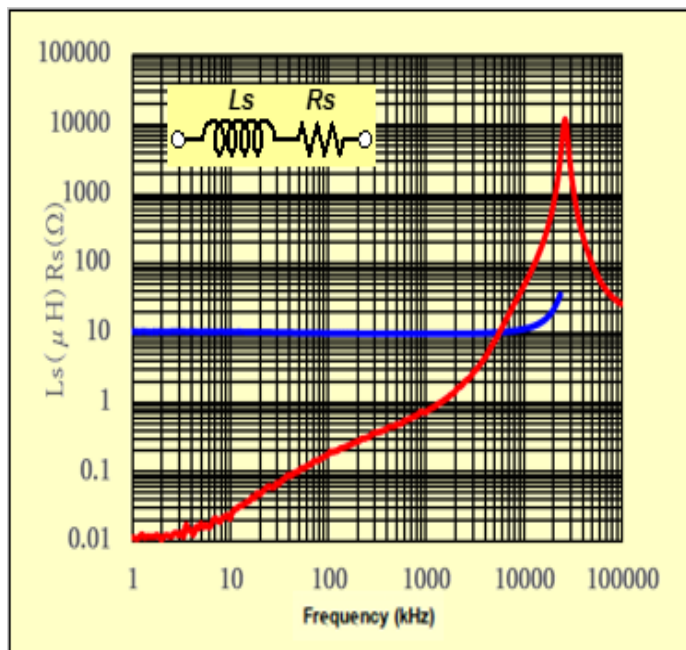

Graph-1 Frequency response

$$P = I^2 \times R$$

● **Specification of current value isn't fixed by wire size**

In general, if a wire is used for wiring, larger current can be supplied to thicker wire. For wire-wound coils also, if the wire is thicker, DC resistance will decrease and the heat generation will become less. Therefore, larger current can be supplied to the coil. However, the current which can be supplied to the coil is not uniquely fixed by thickness of a wire, like **XX amperes (A) for XX mm wire**.

It is because the current limit is fixed by heat generation by current supplied, instead of wire size.

Even though the wire is thin, the coil can endure large current despite its appearance, if it has a structure letting out the heat.

For your reference, we created comparison table between our chip inductor (**C2012CB**) and power inductor (**7E06LB**). As you can see from the values of **Table-1**, the wire size is **three times** different even though the allowable current value is the same. That is, the cross section area is **nine times** different.

Power inductors have a thick wire and the low allowable current value because the heat generated in coil is hard to be let out. We believe that the wire bonding of semiconductor is pretty thin even for high power application.



Table-1 C2012CB and 7E06LB specifications

Type	Inductance	DC Resistance (mΩ) max.	Temperature rise allowable current (mA)	Wire diameter (mm)
C2012CB-15N	15nH	170	600	0.05
7E06LB-470	47uH	610	610	0.12

● **The temperature of coil varies depending on mounting method.**

The heat generated from a coil can be categorized into two: first one is the heat which lets out through the air on the coil surface (air convection), second one is the heat which lets out from the connection of the coil (heat conduction).

Especially, the heat transferred from terminals to the printed wiring board varies depending on the land pattern size. So the temperature of coil will significantly change. Therefore, it is possible to decrease the temperature rising by releasing the heat by using effectively (=increase the size).

In addition, the airflow varies depending on the direction of the printed board – whether placed horizontally or vertically. Therefore, the heat generation of coil may vary.

In an extreme case, if the coil is evaluated under tentative soldering as **Figure-1** at the prototyping, the temperature may decrease more than the coil mounted on the board formally.

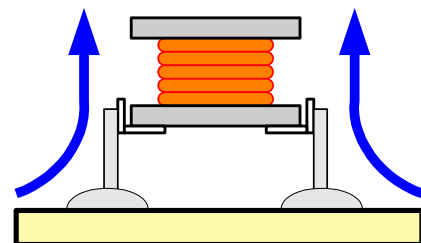
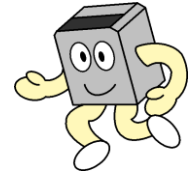

Fig.-1 When floating a coil

Y.Hoshino

Tips for COIL users (5)



● Introduction

The fifth topic is about "**Q of coils**". This **Q** may not be so much familiar to those who mainly use power inductors. However, it is one of important parameters in coils for high-frequency application.

● What is Q?

Q is one of parameters that represent difference (amount of loss) from the ideal coils. When the equivalent circuit of coils is as shown in **Figure-1**, it is calculated in accordance with **Formula-1**. Therefore, "**Q is high = almost ideal coil which has small loss**". When $r_s = 0$, **Q = infinite**.

In those days, we used to measure **Q** with a **Q** meter which was necessity for coil manufacturers. But now we can measure **Q** with a high performance LCR meter (or impedance analyzer) by setting the circuit mode to "**LS+Q**".

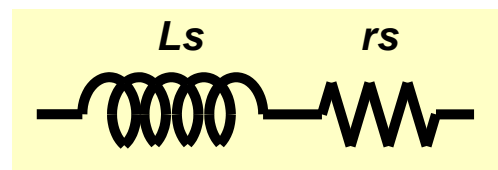

Fig.-1 Equivalent circuit of coil

$$Q = \frac{2 \times \pi \times f \times L_s}{r_s} \quad \text{Formula-1}$$

Q value significantly varies depending on the frequency in spite of same coil. Generally, if the frequency gradually changes from lower value, the **Q** value will reach maximum value at certain frequency. After that, **Q** will decrease gradually (characteristic of litz wire in **Graph-1** on the next page is the general curve).

● Q and ESR

In the capacitors for the power application, not $\tan \delta$ but the equivalent series resistance (**ESR**) is often used. In the same way, not **Q** but **DCR** is employed for the power inductors. For the loss, **DCR** is employed maybe because the resistance is easier for us to understand intuitively than the other factors. Otherwise, **DCR** is easier to be measured.

Both **Q** and r_s (**ESR**) are same in meaning, so they can be converted mutually with **Formula-1**.

● Skin effect and litz wire

In two different coils with bigger/smaller **DCR**, which have a same form, there is the case that **Q** becomes high on a coil which **DCR** is bigger when increasing frequency. The current flowing through a wire is concentrated on a certain level of depth from the wire surface as **Figure-2**, when the frequency becomes higher. Then the current is difficult to flow through deeper area. (The thicker a wire is, the larger wasted area is generated at the center that current never flows). It is called skin effect.

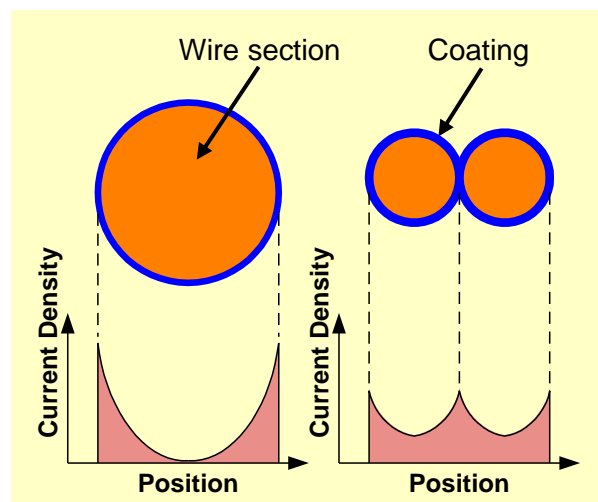
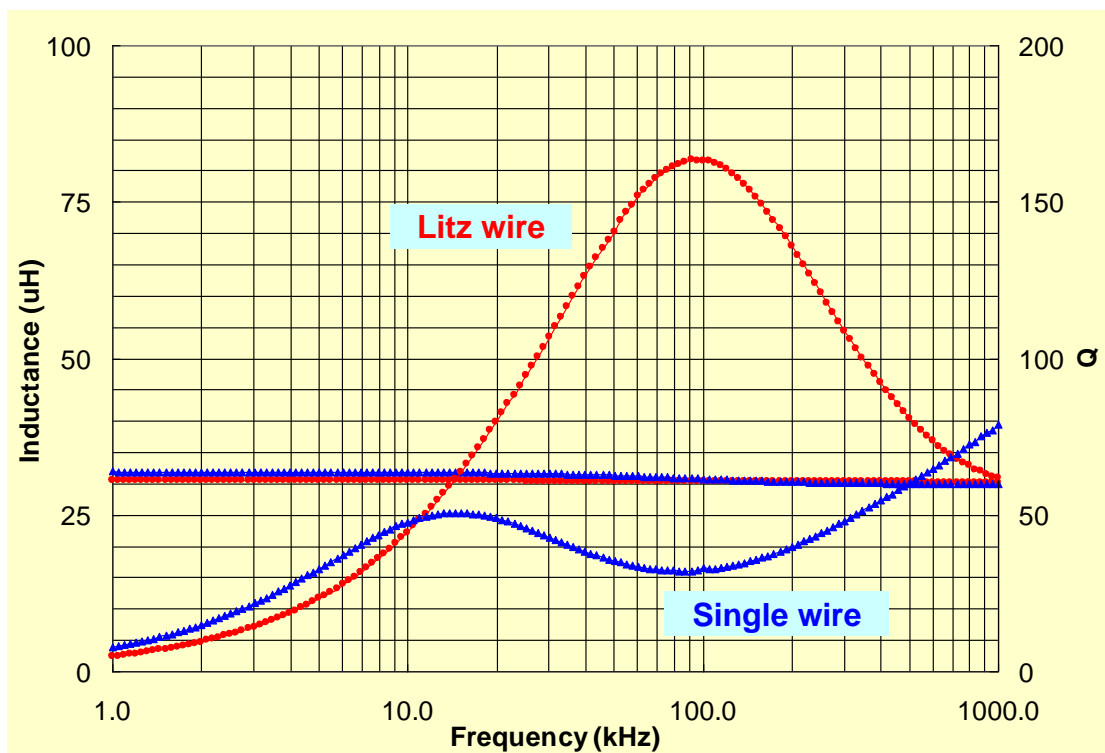

Fig.-2 Skin effect

This is the method to disperse the concentrated current by using the wire of which the surface area is large though the total cross-section area is small. Actually, individual **insulated** thin wires are bundled and they are used as single wire (it is called litz wire). The current can flow into the center area of thin wire.

To confirm the actual effect, **Graph-1** shows an example of coil characteristics of single wire and litz wire that are wound around same ferrite core. As you can see from the graph, the litz wire is not almighty and the effective frequency range is limited. Considering the cost effect, the range of use is also limited.

In the past, the litz wire often had been used to improve **Q** of the antenna coil for AM radio. However, recently it is rarely used because performance (sensitivity) of semiconductors has been improved.



Graph-1 Q vs Wire type

● **To heighten Q**

Generally, the Q value decreases if there is a metal (conductor) around the coil. It is mainly because an eddy current is generated when the magnetic flux which is generated from the coil passes through the metal. (For eddy current, see later topic.)

In the case of RF inductors, high-Q inductors have been realized by making following efforts:

1. Keeping windings away from the metal terminals of the coil.
2. Keeping windings away from the pattern (copper foil) as far as possible when mounting the coil onto the printed wiring board.

The chip inductors with **High-Q** (our **C2012H**) have larger space as shown by **Figure-4**. As the result, the winding area decreases compared with standard

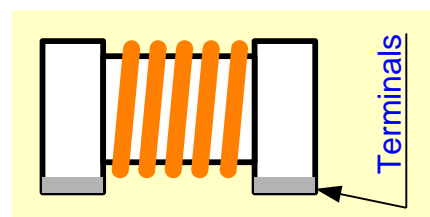

Fig-3 Standard

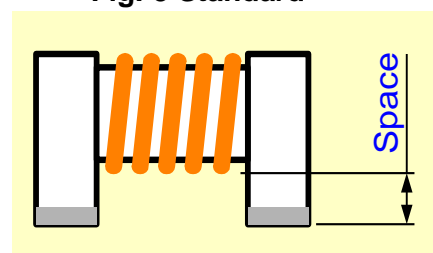

Fig-4 High-Q

one. And producible maximum inductance becomes small. However when comparing in the same inductance, higher **Q** is **achieved**.

This may be a trivial thing but we are making such continuous efforts to improve the coil characteristics.

Also the open magnetic power inductors may have some effects (not so large as RF inductors), if the printed wiring pattern (copper foil) is just under the coil.

● **Concerning gap (supplement of third topic)**

This is a supplemental description about the gap in third topic.

If the only gap size is changed under the same conditions of ferrite core and windings (see **Figure-5**), the characteristics are as **Graph-2** below. The relationship between inductance and DC saturation allowable current is mutually dependent.

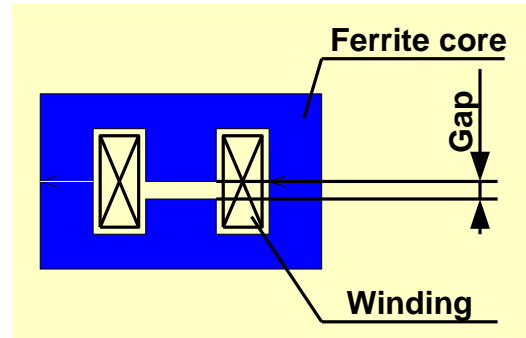
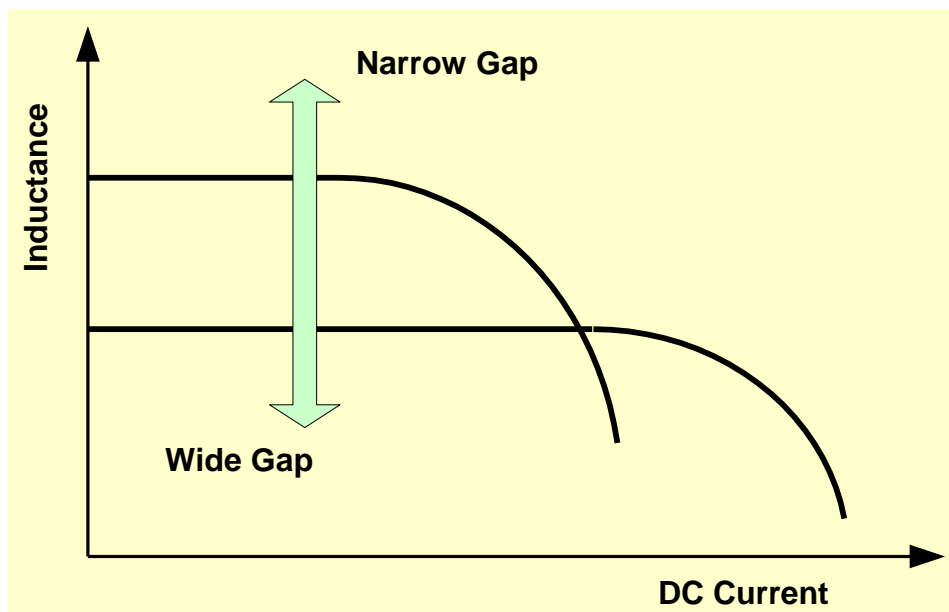

Fig.-5 Gap



Graph-2 Gap vs Characteristics

If we want to increase the inductance and the inductor has gap, we can realize that by narrowing the gap without increasing DCR. However, because of the form (structure), limited type of inductors can change the inductance by changing the gap.

Y.Hoshino

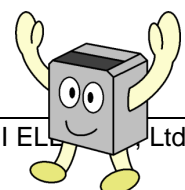

Tips for COIL users (6)

● Introduction

The sixth topic is about "**self resonance frequency of inductor**". Actual components are different from ideal ones in many aspects. Some aspects show unexpected characteristics.

● What is self resonance frequency?

Normal frequency characteristic of impedance of inductor ($Z=R+jX$) is measured like a blue line in **Graph-1** (plotted only jX). (Graph is according to our **CER1277B**, 100uH) For your reference, red line shows the frequency characteristics of 100uH at ideal conditions.

In **Graph-1**, the frequency which shows reversed impedance polarity is called **Self Resonance Frequency = SRF**.

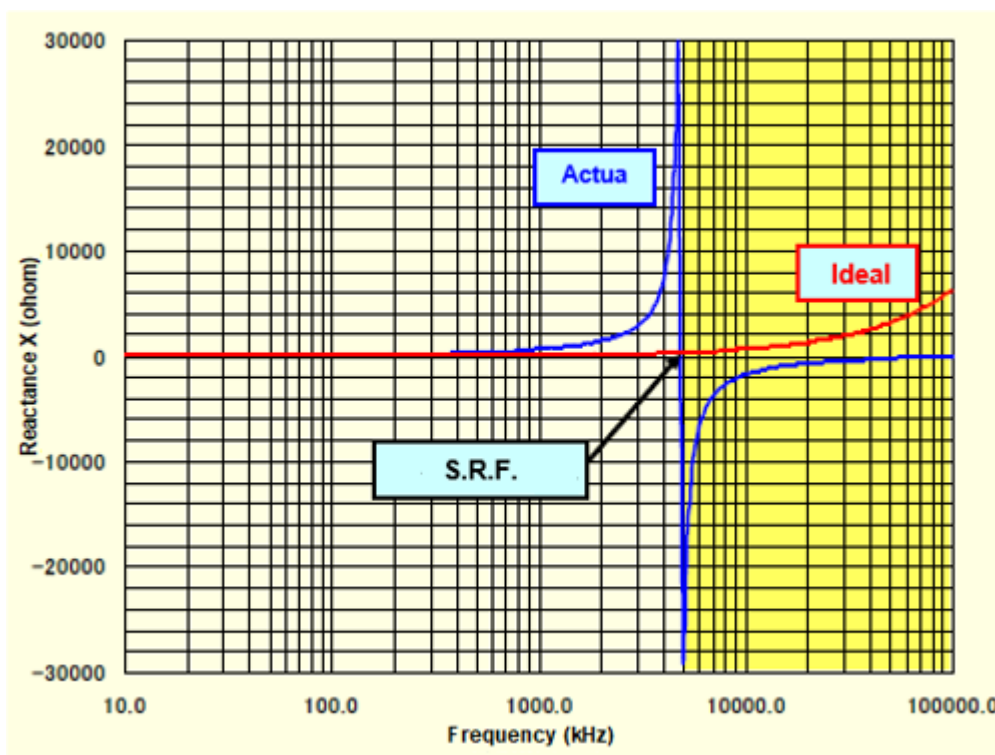

Graph-1 Impedance(X) characteristic

● Source of SRF

In actual world, if electrodes have width (size), capacitance (capacitor) occurs. Such capacitance is called as the parasitic capacitance, the distributed capacitance, the floating capacitance, and the stray capacitance. Therefore, in general the capacitance (capacitor) **Cp** is added to the equivalent circuit of inductor in parallel as **Figure-1**.

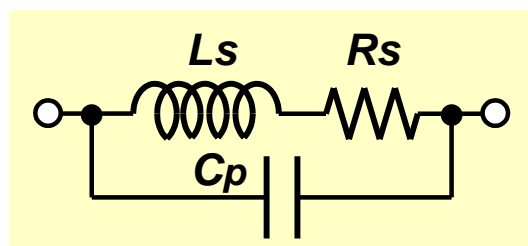
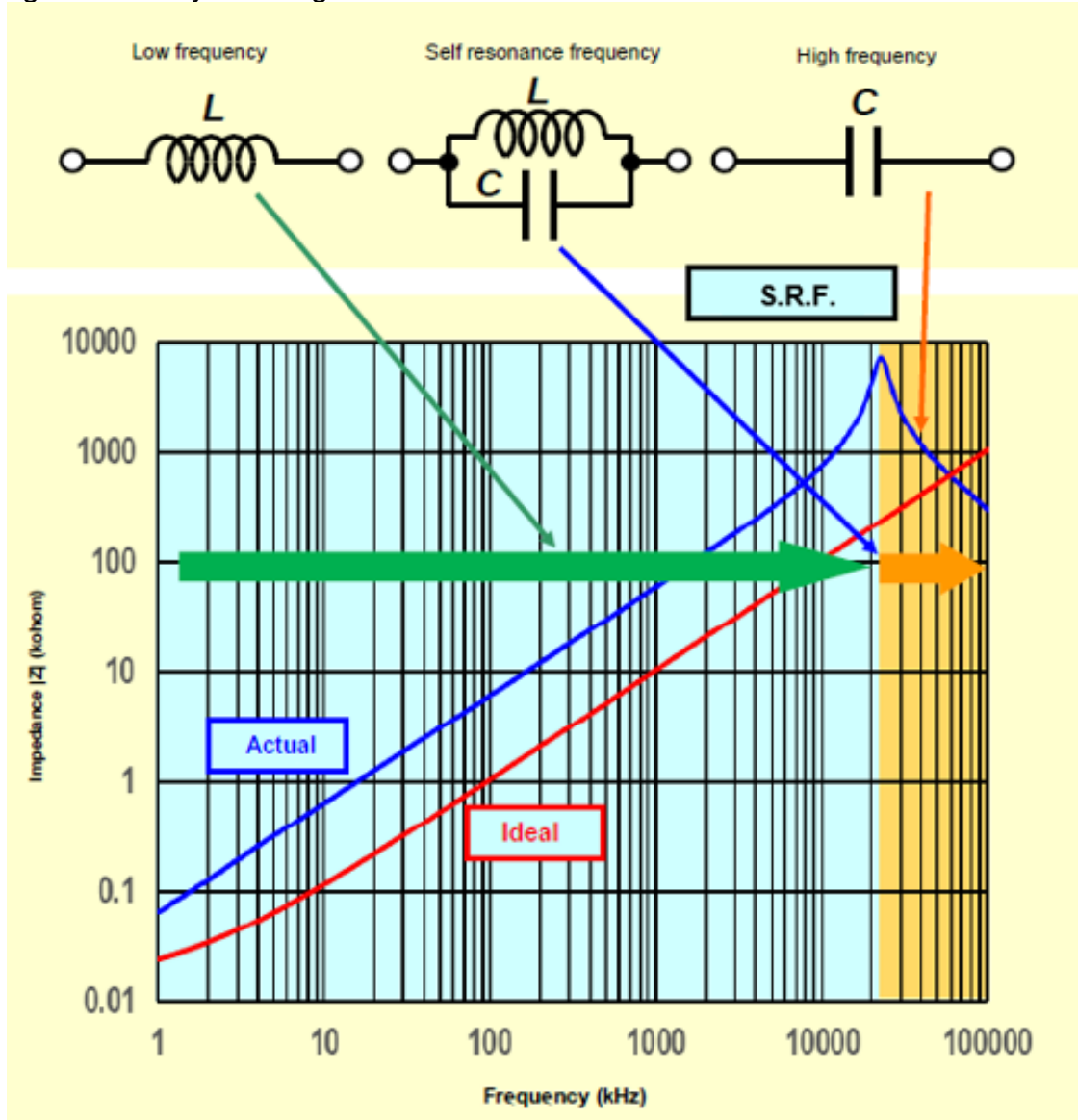

Fig.-1 Equivalent circuits

This capacitance C_p and own inductance L_s of inductor resonate, and the frequency response is as **Graph-1**.

Generally, the resonance phenomenon doesn't happen only (with?) the inductance. However, it happens by the resonance itself without connecting capacitor in parallel, so it is called self resonance frequency (**SRF**).

The **SRF** is inevitable, but special coils exist, which decrease C_p and move the SRF to higher value by devising the coil structure.



Graph-2 Impedance characteristic and Equivalent circuits

● **Actual SRF of inductor**

Measurement value for the SRF and stray capacitance (C_p) of our power inductor (**CER8065B**) are described in the **Table-1**. In general, the value of stray capacitance does not increase in proportion to the inductance. However, although it doesn't increase so much as the inductance, when the inductance value increases, the stray

Table-1 S.R.F. vs Stray Capacitance

Inductance L_s (uH)	Self Resonance Frequency (MHz)	Stray Capacitance C_p (pF)
10	26.0	3.7
100	5.2	9.4
1000	1.2	17.6

capacitance will also increase and the self resonance will decrease.

The differences of impedance characteristic for each inductance (position of **SRF**) are shown in **Graph-3**.

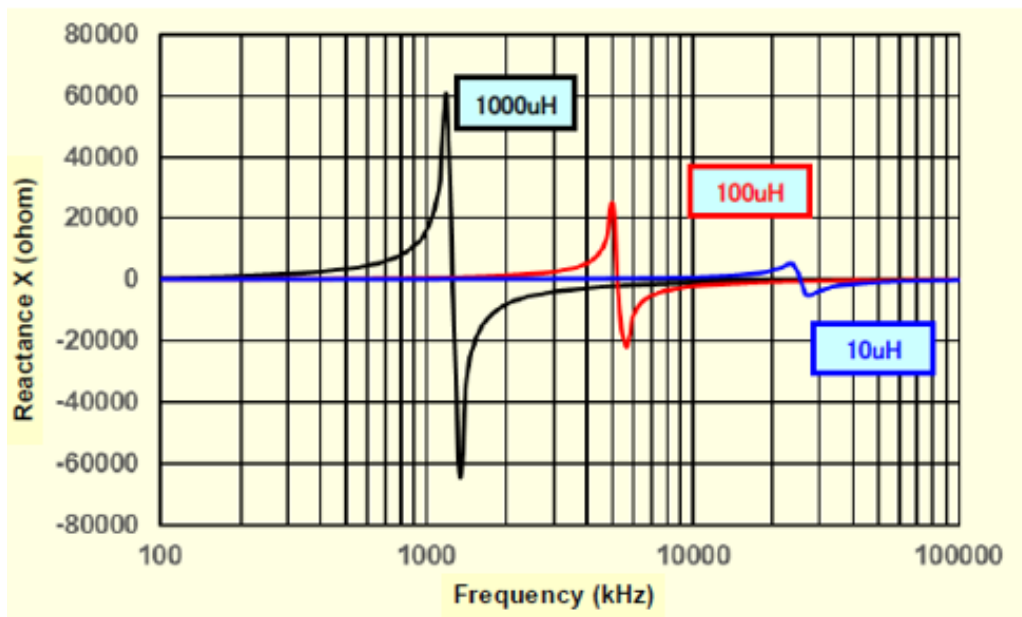

Graph-3 Impedance characteristics with different inductance

● **Precautions for use related to SRF**

- 1) When the inductors are mounted on a printed wiring board, the stray capacitance increases due to wiring. Therefore, the SRF moves to lower area compared with the case of single inductor.
- 2) The stray capacitance of inductor is relatively small. So, the self resonance frequency value may significantly change due to increased stray capacitance (capacitance between printed patterns) by mounting.
- 3) Usually, if the frequency is less than or equal to 1/10 of the self resonance frequency, such effect should not be a big problem.
- 4) Impedance value increases around the SRF. So if you make better use of that, you may expect to obtain the effect more than inductance value. However it requires a care, for the SRF may vary widely because it is not created intentionally.

Y.Hoshino

Tips for COIL users (7)

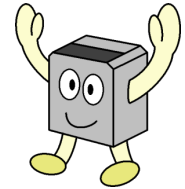

● Introduction

The seventh topic is about "**Open magnetic and shielded**". Fortunately (With your support), we have completed the half of schedule (total 12 times), and we will enter the second half.

● Coil and magnetic flux

When a current is supplied into a coil, a magnetic flux is generated. The problem here is when the magnetic flux passes through a metal (conductor), adversely an inductive current (eddy current) is generated in the metal (such as copper foil of printed board). As this current is not intentionally generated, it may adversely affect the operation of circuit. For detail, we'll describe in the next "magnetic shield".

● Shielded and open magnetic

A coil (inductor) involves a magnetic flux. The coil structure which is called shielded structure prevents such magnetic flux from leaking out of the coil. (There is the coil with the structure that avoids this magnetic flux to be leaked outside so much. This is called Shielded structure (or simply Shielded.) The structure of which the magnetic flux is still outside of coil is called open magnetic structure. (By contraries, there is the coil with what we call Open magnetic structure, which the magnetic flux is flowed outside freely.)

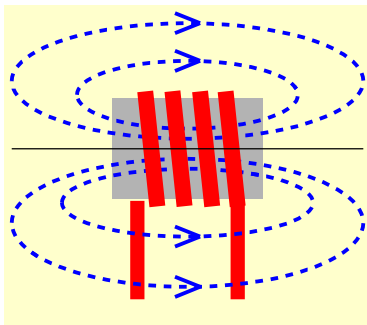

Figure-1 Open magnetic

The magnetic flux of coil circles around the coil and forms a loop like **Figure-1**. Therefore, in case of the open magnetic, the magnetic flux widely spreads around the coil. The way to make the shielded structure is to cover and hide the windings with the magnetic substance, and fill the flux path with magnetic substance. By doing so, the magnetic flux passes through the magnetic substance, and it is not leaked out of the coil.

For example, if the magnetic substance covers the sides of coil, the leakage of magnetic flux becomes less, as the magnetic flux passes through the magnetic substance like **Figure-2**.

If the magnetic substance covers the other side of coil as well, surely the leakage of magnetic flux can become less.

By the way, some coils have the shielded structure though the windings are exposed.

Typical example is the toroidal coil (**Photo-1**).

The magnetic flux which is generated from the coil doesn't spread outside, as it forms a loop by passing through the core within the coil. Recently downsizing of set is being progressed rapidly, so the shielded coil is preferred to avoid influence of each adjacent component.

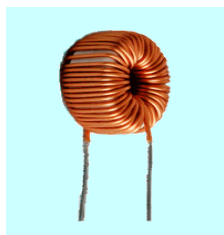

Photo-1
Toroidal coil

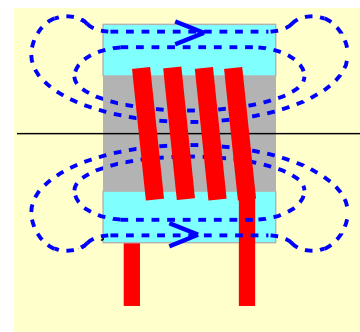

Figure-2 Shielded

● **Definition of shielded**

There is no clear rule (definition) where the range of shielded ends (to judge what is Shielded) in any specifications of components (component standard) and the industry.

Once a manufacturer declares a coil as "shielded", it will be regarded as a shielded coil.

In such situation, it seems that new words have been created to differentiate own products, such as "**full shielded**" and "**half shielded**".

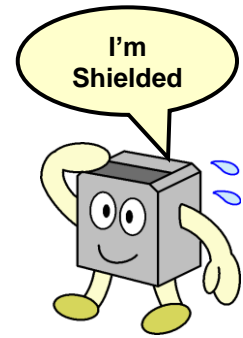

● **Differences of characteristics**

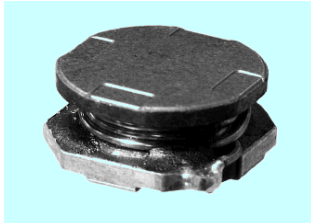

Photo-2 CWD1045C

For inductors, differences are found in the DC saturation curve between the shielded and the open magnetic inductors. These differences arise from the magnetic structure. The shielded tends to gradually decline according to increasing the DC saturation current. On the other hand, for the open magnetic, the DC saturation curve tends to extend. Of course, tendency of curve varies depending on characteristics of magnetic materials which are used.

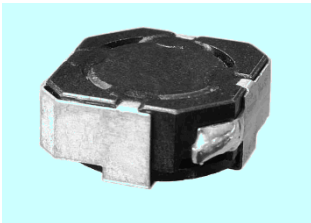
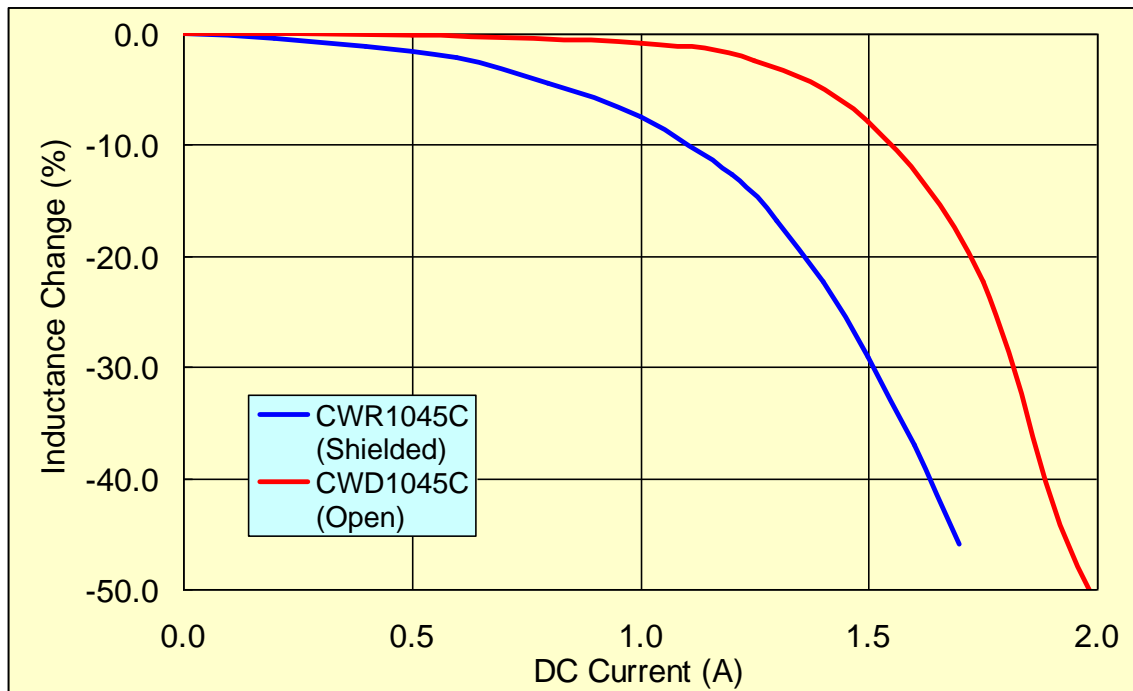

Photo-3 CWR1045C

Graph-1 shows the characteristics comparison of our automotive power inductor **CWD1045C** (open magnetic inductor) with **CWR1045C** (shielded) based on the same inductance. As **CWD1045C** with the open magnetic has open magnetic structure and the magnetic saturation is hard to occur, the DC saturation allowable current extends.

※CWD1045C,CWR1045C This product is not currently in the lineup.



Graph -1 Inductance Saturation Characteristics

Generally, the shielded inductors have larger effective permeability (μ_e) than that of open magnetic inductors, as the structure of shielded can seal the flux in.

Then when both have the same inductance value, we can decrease winding turns of the shielded one.

However, as the area where we can wind the wire in a coil (for winding wire in a coil) is small because of coil's form (structure), if the winding turns are same as the open magnetic, you need to reduce the wire thickness of the shielded one.

As the result, for the DC resistance (also the temperature rising current), the differences of both tend to become smaller (for shielded, we can decrease the winding turns, while the wire diameter becomes thinner).

Y.Hoshino

Tips for COIL users (8)

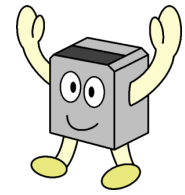

● Introduction

The eighth topic is concerning "eddy current and magnetic shield".

● Magnetic shield

To shield a coil, there are three ways; to reflect, to absorb and to divert unnecessary signals.

The magnetic shield which shields a magnetic flux (magnetic field) covers a coil with a magnetic material (the magnetic flux is easier to pass more easily through the magnetic material) as Figure-1.

Then the shield diverts and blocks off the magnetic flux (by concentrating the magnetic flux in the magnetic materials). Not only the shield can block off but it also prevents unnecessary signals from leaking from inside.

Some shielded inductors have structure which covers outside of coil with the magnetic material, so that the magnetic shield prevents flux inside of the coil from leaking.

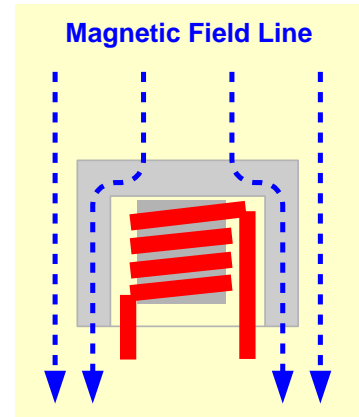

Fig.-1 Magnetic shield

● Eddy current and effect

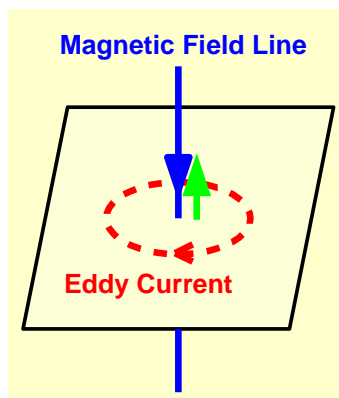

Fig.-2 Eddy Current

When the magnetic flux which passes through the metal varies (magnetic field by alternate current), an eddy current is generated on a metal surface to deny (Green arrow in Figure-2) the variation of original magnetic flux as Figure-2. The magnitude is proportional to the frequency (low frequency = small electromagnetic induction as variation of flux is small).

In addition, the higher conductivity is, the more the current flows. Therefore, the metal materials such as copper or aluminum have large eddy current.

As the eddy current value is proportional to the frequency, we can expect the advantage of offset at high frequency, not at low frequency.

As we explained earlier, the eddy current flows in direction that offsets magnetic flux. Due to that, when the metal is placed near to the coil, the inductance value may decrease or the loss may increase (= decreased Q).

The shielded inductors are not affected so much because it has a small leaking of magnetic flux in structure. Meanwhile, the open magnetic inductors are affected more because the magnetic flux is exposed around the coil.

When the inductor is placed on a printed wiring board, if its position is near to the ground pattern or the metal part of chassis, the eddy current flows and the inductor may be affected by it.

● Magnetic materials used for coil

We can increase inductance by using magnetic material. But as the magnetic flux passes through the magnetic material, the eddy current occurs if the magnetic material has conductivity (metal). As the electrical characteristics get worse when the eddy current flows, it is generally understood that magnetic material for coils must be

insulating material such as ferrite, which no eddy current flows.

There are some power inductors of which DC saturation current has been improved by using the metal as the magnetic material. Even in that case, metals are powdered and insulated to prevent the eddy current from flowing among powders, so that no loss by the eddy current is generated (refer to Figure-3).

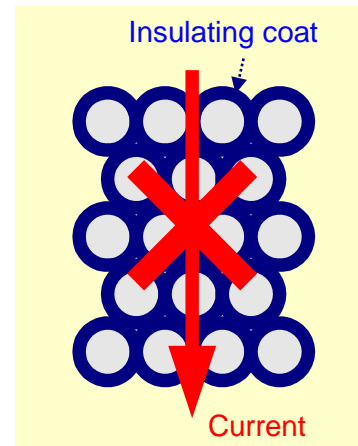

Fig-3 Current does not flow into insulator.

● **Electromagnetic shield**

For the magnetic shields, the coils are shielded with the magnetic materials. On the other hand, some shields reflect and block off outside by using the eddy current. When the frequency is low, the eddy current is hard to flow (= shield effect is small), so the advantage may not be expected.

However, when the frequency is high, the magnetic field (electromagnetic shield) can be generated by making use of the phenomenon that the eddy current offsets the magnetic flux. In general, effect of electromagnetic shields with metal is expected from more than approximate 10 kHz in frequency.

In this case, the materials for shield are not the magnetic materials, but the metal materials in which the current flows well (such as copper, copper alloy and aluminum). In addition, for the electromagnetic shields, by connecting the metal to the ground, the advantage can be expected as the electrostatic shield.

● **Effect of electromagnetic shield**

We covered the open magnetic inductor with phosphor-bronze plate in thickness of 0.1mm, and measured it (Photo-1).

Characteristics are shown in Graph-1 as follows: a single coil (**Red line**), a coil which avoids contact with the edge of phosphor-bronze (**Blue line**), and a coil which is fully connected to the edge by solder (**Green line**, image is shown in Photo-1, right side).

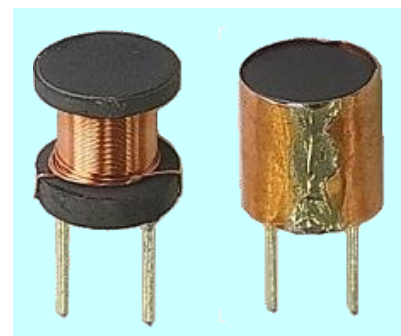
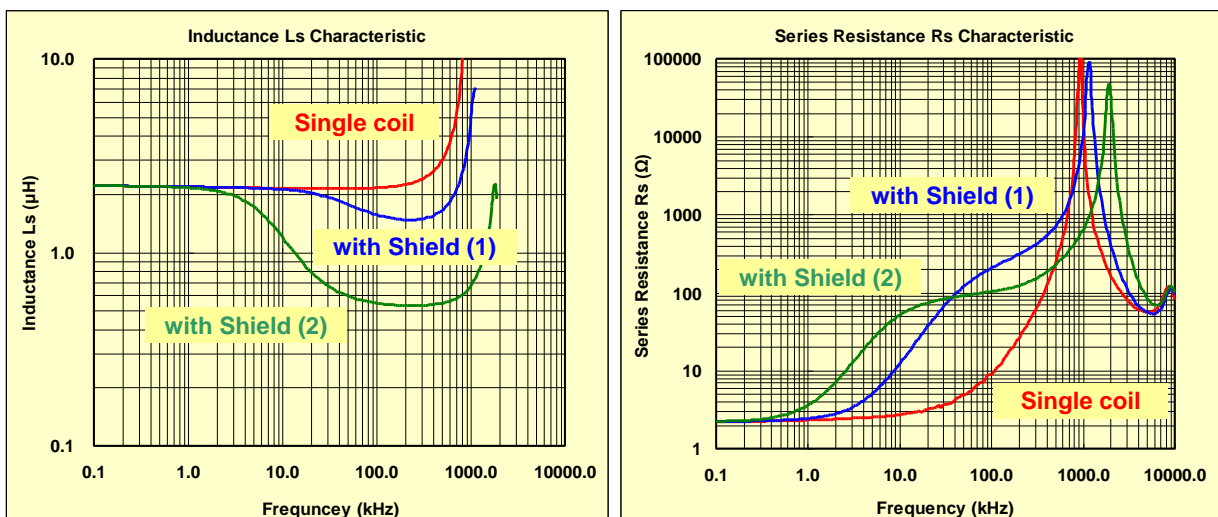

Photo-1 Evaluated Coils



Graph-1 Effect of Metal shield

The way of the eddy current flows varies among them as well as characteristics. Especially, the eddy current itself is small at low frequency, so we can find that the effect (the advantage as shield) is also small.

For electromagnetic shields, it is important to ensure the conduction of connection area.

For the radio frequency coils, the metal case is used to shield, but it isn't used for the power inductors.

Because in the case of the open magnetic inductors the electrical characteristics decrease significantly (inductance decreases and loss increases) against the advantage of shield. Also in the case of the shielded inductors, advantage of shield is low despite the increased cost.

Y.Hoshino

Tips for COIL users (9)

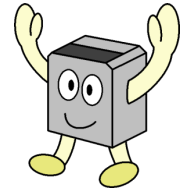

● Introduction

The ninth topic is about "temperature characteristic and insulation characteristic" that are the rest of characteristics.

● Temperature characteristic of inductance

Most of coils are made by using magnetic materials. As the result, the coil characteristics vary depending on magnetic materials and a coil structure (magnetic structure).

For ferrite cores which are used as the magnetic materials, most of permeability (μ) have the positive temperature characteristic. Therefore, in general the temperature characteristic of inductance is also positive (if the temperature rises, the inductance increases). However, even though same materials are used for a coil, if the structure is different, the temperature characteristic may significantly vary.

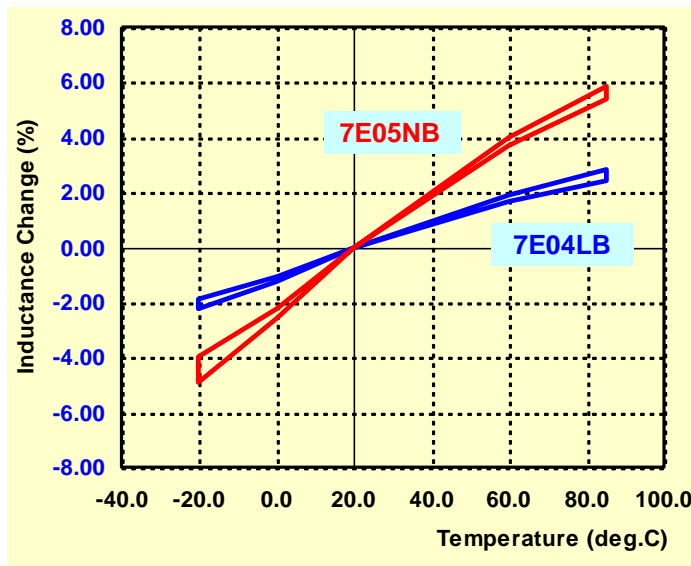

Graph-1 Temperature Characteristic-1

Graph-1 shows an example of temperature characteristic of 7E04LB and 7E05NB, our power inductors. Two coils have almost the same structure, but there is a difference in the temperature characteristic because the ferrite core materials are different. When we develop the power inductors, we put more value on the DC saturation current than the temperature characteristic of inductance. Therefore, such difference may appear. Although the appearances are similar, the characteristics are not

always same. Therefore, please confirm the temperature characteristic as required.

Graph-2 shows an example of temperature characteristic of our inductor 7G14C for digital amplifier. Please note that the scale (blue) of vertical axis is ten times different between Graph-1 and Graph -2.

※7E05NB This product is not currently in the lineup.

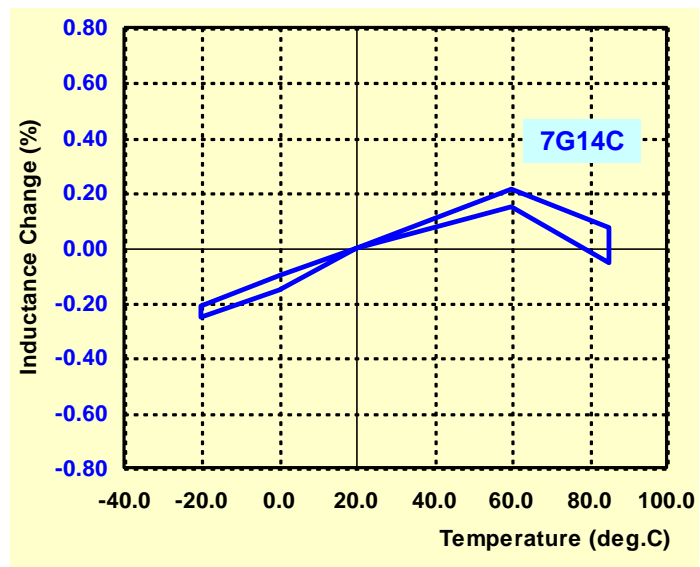

Graph-2 Temperature Characteristic-2

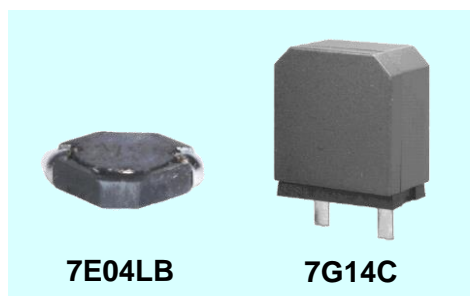
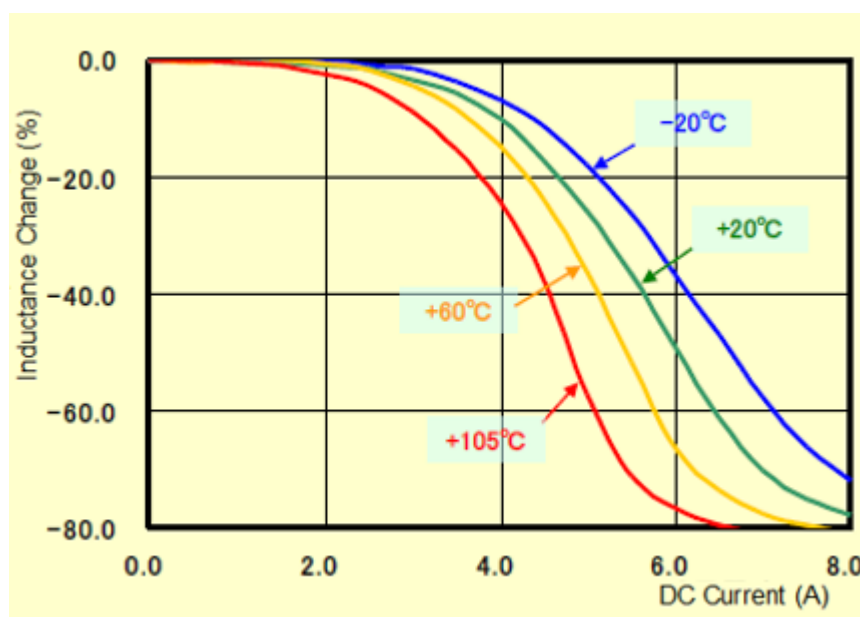

Photo-1

All **7E04LB**, **7E05NB** and **7G14C** are shielded inductors, but you can find that "**variation for inductance temperature**" is significantly different due to the structure difference. It is not that the temperature characteristic is set as large value intentionally.

● **Temperature characteristic of DC saturation allowable current**

When the temperature rises, generally a curve of DC saturation current of power inductor comes to the left side like **Graph-3** (characteristic example of our **CER1042B**). Although the level varies depending on the structure and the ferrite core materials which are used, it tends to be like the one in **Graph-3**. For the power inductors, it is important to confirm the variation of characteristics based on high temperature, because the power inductors generate heat by themselves when the current is supplied, and they are mostly used at the place where the temperature relatively rises.



Graph-3 DC Saturation Characteristic

● **Insulation resistance**

There are two kinds of ferrite cores which are used for coils: nickel series (**Ni-Zn**) and manganese series (**Mn-Zn**). Outstanding difference except magnetic characteristic is volume resistivity. The nickel series is **1000000Ω·m** and the manganese series is **0.1 to 10Ω·m**. The metal is around **0.00000001Ω·m**.

It is difficult to understand, so we tried measuring the surface of ferrite core of manganese series. And when "the gap of probes was **5mm**", the value was around **150kΩ**.

For the nickel series, it is acceptable to consider the ferrite core as the insulation. For the manganese series, the ferrite core is available in the range of general voltage.

However, some measures are necessary in the high-voltage circuit, or the circuit for which the insulation is important.

Therefore, for the manganese, the surface of ferrite core is insulated to maintain the characteristics equivalent to the nickel series depending on the application (It is employed for our power inductor series **HER**).

Generally, the nickel series is used for the power inductors, and the manganese series is used for the transformers. However, the (insulated) manganese series is used for some power inductors to improve DC saturation allowable current.

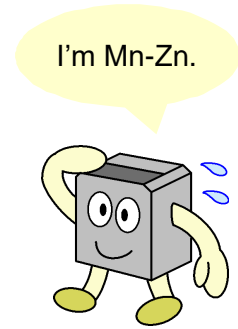

Y.Hoshino

Tips for COIL users (10)

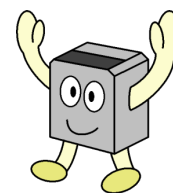

● Introduction

The tenth topic is about "**the operation (performance) of coils**". There are various modes for the coil operation, so it might be more difficult to understand than other components.

● Utilization of inductance-1 : Resonance circuit

Combination of coil (**L**) and capacitor (**C**) generates a resonance. For a parallel resonance circuit, an impedance between terminals reaches a peak at the resonance frequency (For a serial resonance circuit, the value is least).

We can extract a signal of specific frequency or conversely remove it with such phenomenon. In addition, the value of resonance frequency (f_x) is calculated by following formula.

$$f_x = \frac{1}{2\pi\sqrt{LC}}$$

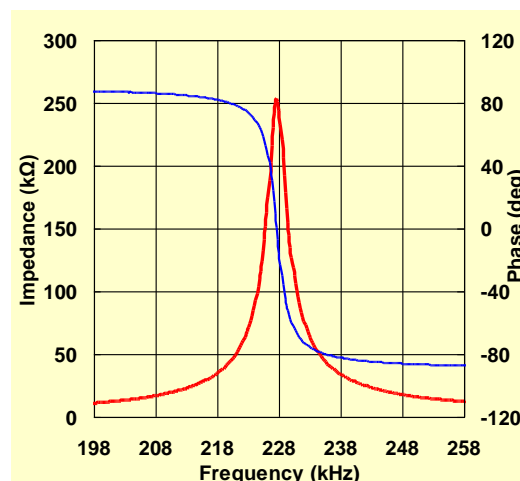

Graph-1 Impedance Characteristics

The parallel resonance circuit was prepared with **L=2.2mH** and **C=220pF**, and the frequency characteristic of impedance (**red**) and the phase (**blue**) was measured as shown in Graph-1. The resonance frequency is almost consistent with the calculated value = 229kHz. In this case, the higher Q is, the sharper the mountain figure of impedance characteristic becomes, also the impedance value at peak increases.



Photo-1 5CHH

When the inductance value changes +/-5.0%, the resonance frequency changes +/-2.5% which is about half of inductance changes.

Therefore, variation of inductance value is important. There are coils of which inductance value was variable. They are called variable coils, and in those days they were often used for high frequency circuit.

Photo-1 is a variable coil of SMD (5CHH type). When we insert the screw driver to the surface groove and turn it, the upper magnetic substance moves up and down. This can change the inductance (approximately +/- a few % to +/- 10 %).

※5CHH This product is not currently in the lineup.

● Utilization of inductance-2 : LC filter

The LC filter is one of application which utilizes the inductance. In the case of filter without the resonance circuit like L.P.F (low-pass filter: Figure-1 is third order L.P.F) and H.P.F, the filter characteristics are determined by inductor and capacitor. Even though the inductance value changes, the effect is not so large as resonance circuit.

Besides, in the case of L.P.F which is used for noise removal of power supply circuit, if we consider the minimum

inductance value of inductor in advance, mostly the large tolerance product can be used.

In this case, theoretically larger inductance is preferred. However, it is adverse effect to produce larger inductance than required, because the actual coils have DC resistance and self resonance frequency.

The inductors used for switching power supply are categorized into LC filter and energy conversion. For the LC filter, only DC resistance is important (high frequency loss can be ignored).

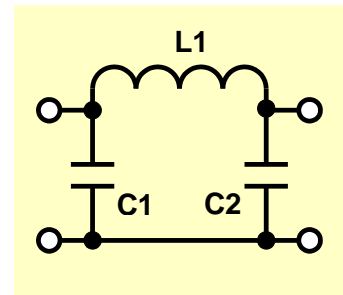

Fig-1 L.P.F.

● Utilization of energy accumulation effect

Like capacitors, coils can accumulate electric energy. It is easy to understand about capacitors because they are voltage element. On the contrary, it is a little bit difficult to understand about coils because they are current element (current mode). To build the switching power supply, following processes are repeated and controlled: 1. turning the power on, 2. supplying current through the coil, 3. accumulating the current, 4. switching to load, and 5. supplying current.

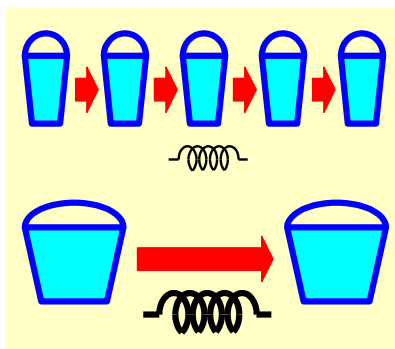

Fig-2
Difference of bucket size

To carry a constant amount of load, there are two kinds of ways: carry with larger container and fewer carrying times, or carry with smaller one and more times (see Figure-2).

Applying this to switching power supply, carrying times are the frequency, and size of container is the inductance. Therefore, when switching frequency is high as a recent trend, inductance used for inductor can be small (small inductor is available). Actual inductances vary depending on output condition).

In the case of switching power supply, the frequency can cover the unevenness of inductance to some extent. Instead, the loss resistance directly effects the power efficiency, so it is important that the coil loss (DC resistance and resistance of operational frequency) is low.

● Utilization of magnetic flux (magnetic coupling)

Coils can work uniquely by using magnetic coupling. Other components such as capacitors can't work like that.

Transformers which some wires are connected are widely used for low frequency wave (mainly electronic circuit) to high frequency (mainly impedance transformation). Photo-2 shows an example of balun transformer for high frequency.

Individual windings are not so important for transformer (in most cases only lowest cost are required). Instead, it is generally important connection state of windings and turn ratio.

Some coils make good use of the magnetic flux; a common mode filter is one of them. Signal (differential signal: blue) flows in a different direction from common mode noise. With this, two coils are connected to negate the magnetic flux of signal as Figure-3. As the result, the magnetic flux doesn't affect the signal.

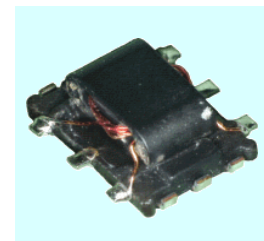

Photo-2 4BMH

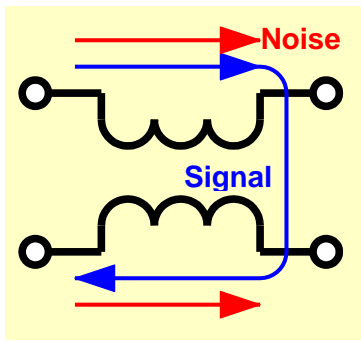
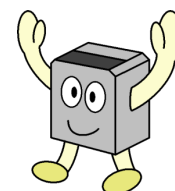

Fig-3
Common mode Coil

In contrast, for common mode noise the magnetic flux operates as the inductance and works to prevent the common mode noise passing. The magnetic flux affects only the noise without the signals. This prevents the signal from deteriorating. Required (=important) electric parameters for coils vary up to the circuit which is used (= coil characteristics which are used). Therefore, we vary the description specified in the general specification depending on the application of product.

Y.Hoshino

Tips for COIL users (11)



● Introduction

The eleventh is about "**coupling between coils**". Let's see what is the condition of coupling when multiple coils are aligned.

● Direction of magnetic flux

Direction of magnetic flux which is generated from a coil depends on a winding direction (**right and left winding**) and a current direction which flows through a coil (**blue arrow**).

Therefore, in the case of **Figure-1 (A)** and **(B)**, the winding and the current directions go across each other. Therefore, the direction of magnetic flux is same.

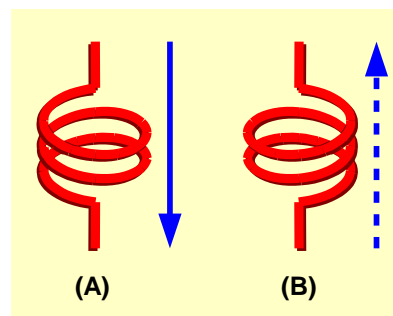

Fig-1
Direction of Magnetic Flux

● Indication of inductor polarity

When two or more coils are placed, magnetic fluxes that are leaked from a coil may influence one another.

Therefore, a polarity is marked as shown in **Photo-1** depending on products.

Normal coil has a "**winding start**" physically, however the winding direction is not always the same for all forms because of production method.

Originally the indication was used to show a coupling direction of coils with multiple windings like transformers.

Normally, all winding direction is same. In addition, the direction of magnetic fluxes is leaked outside is not specified.

Then, such indication was used also for inductors. Therefore, physical "**winding start**" is indicated generally at the present day.

Originally, the indication should be in accordance with the electric characteristic like a polarity of electrolytic capacitor. However, as there is no industry standard for the indication of inductor polarity, we can't ensure the 100% compatibility. Therefore, both "winding start" and "winding direction" may be specified in a coil specification.



Photo-1 Winding Start

● Placed two coils close together

Two inductors were aligned (**Figure-3**) and measured to confirm a coupling between coils.

TG output of spectrum analyzer was added to an inductor (**L1**), and an output of the other inductor (**L2**) (= input power) was measured based on measurement circuit specified in **Figure-2**.

At this time, **TG** output was set in order for input value to be **0dBm** without **inductors (L1 and L2)**.

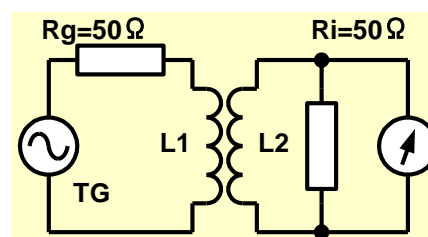

Fig-2 Test circuit

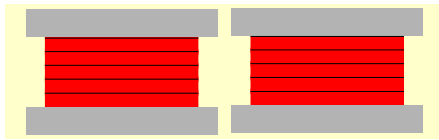

Fig-3 Coil's layout

Two individual coils being coupled is the same structure as transformer. Therefore, some power of either coil is transferred to the other coil. However, generated power is very small because the coupling is not so much as the transformer has.

Graph-1 shows a comparison between an unshielded SMD inductor (**7A10N**) and shielded one (**7E08N**) concerning coupling between coils.

In the case of the unshielded inductor, input power decreases (=coupling is small) because not all leaked magnetic fluxes enter into the adjacent coil. In the case of the shielded inductor, the graph shows that the input power decreases about **20dB** more than the unshielded one due to the effect of magnetic shield.

Then in the case that the shielded inductors are separated about **4mm** (about half of dimension) and measured, it was confirmed that the input power decreased about **10dB** (light blue).

You can find that the shielded inductor performs effectively when multiple coils are closely placed.

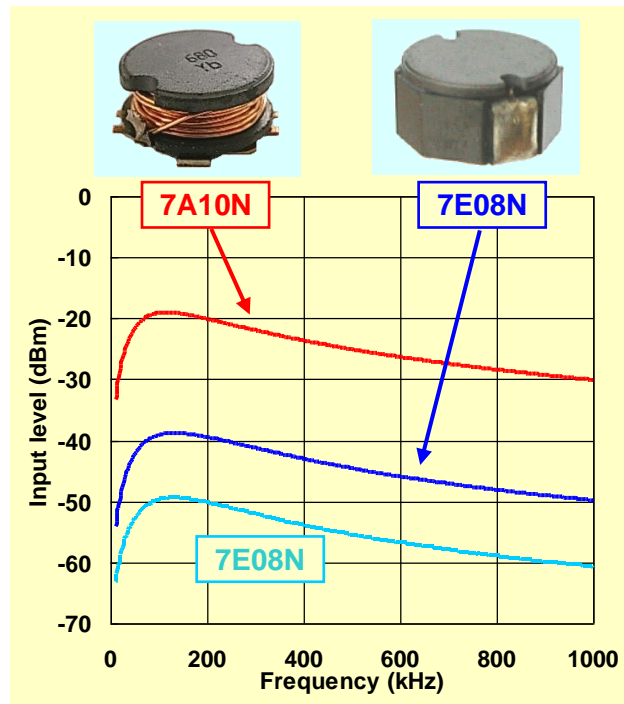

Graph-1 Comparison with 7A10N and 708N

※7E10N,7E08N This product is not currently in the lineup.

● **2 in 1 Type**

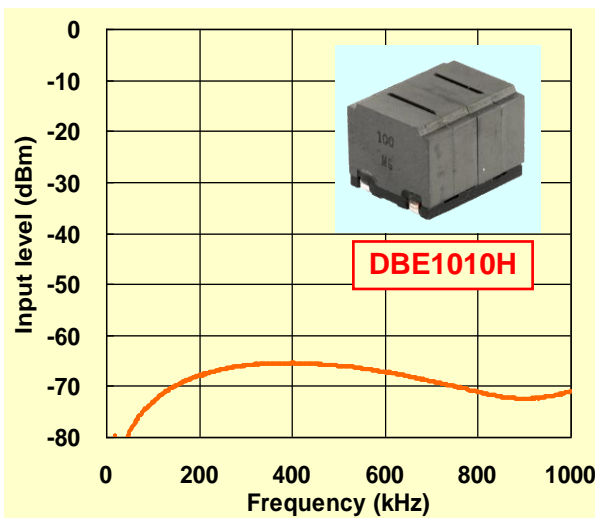

Graph-2 Characteristic of DBE1010H

We have some types of **2 in 1** products among our class D amplifier coils. For those products, we achieved the reduction of mounting work by half and reduced the mounting area by putting two coils together.

When two coils are closely placed, coupling between coils is concerned. However, in fact, each coil has a large shield effect and coupling between coils is very small.

Graph-2 shows measurements of our DBE1010H, **2 in 1** type for class D amplifier. The coupling between coils is smaller than when the normal shielded coils are aligned.

● **High frequency**

For high frequency circuit, air core coils and chip inductors are often used due to small inductance. When these coils are placed perpendicularly like Figure-4, magnetic flux from either coil is hard to go through the winding circle of the other coil. As the result, coupling of mutual coils is minimized.

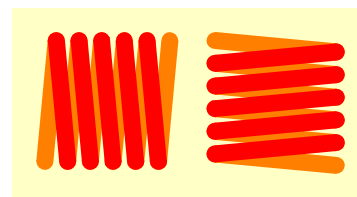
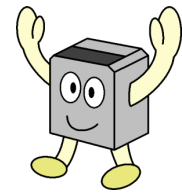

Fig-4 orthogonal layout of two coils

Y.Hoshino

Tips for COIL users (12)



● Introduction

The last twelfth topic is about "Tips when you use a coil".

● For better understanding of coil performance

Although a coil and a capacitor are same electronic component, there may be more difficulty to understand coil, comparing with capacitor. It may be because the capacitor is a **voltage element** while the coil is a **current element**.

It is generally known that "It can be used if the electronic device has the same operation voltage". Therefore, even ordinary people know that "a product with AC 100V cannot be used at AC 200V".

So, which phrase do you think is easier to understand, (1) or (2)?

(1) When applying voltage to a resistor, a current flows in the resistor.

Voltage → Current

(2) When a current passes through a resistor, a voltage occurs at both ends of resistor. Current → Voltage

Probably, most of people think it is easier to understand (1). The coil and the capacitor are in an electrically-opposing relationship. So, when you think an performance of coil (**current**), it may help you when it is compared with capacitor (**voltage**). Let us see the contents which are paired in **Table-1**.

Table-1

Capacitor	Inductor
Voltage	Current
Voltage source	Current source
Parallel	Series
Series	Parallel
Open	Short
Short	Open
$E = 0$	$I = 0$
$I = \infty$	$E = \infty$

When we explain with figures, **SW is turned on** in the connection diagram on the left of **Figure-1**, and a voltage is applied between terminals of capacitor. Then SW is turned off so that it is **charged**.

After that terminals are contacted (SW is closed), a **big current (i)** flows for a moment as shown in Figure-2 (The spark tells you that the electrical energy was generated).

In the same way, **SW is turned off** in the connection diagram on the right of **Figure-1**, and a current is supplied to the coil. Then SW is closed like a loop with **keeping the current flowing**. After that the power is separated.

Then, when **the circuit is opened (SW is opened)**, a **big voltage (e)** is generated for a moment as shown in a **Figure-2**. Actual discharge event shows that the electrical energy is generated.

I hope that in this way, it could be understood that the coil and the capacitor are same if we think from a different aspect,...yet you may still think it is easier to understand the voltage!

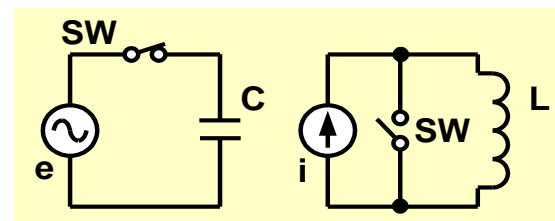

Figure-1 Charge to capacitor/coil

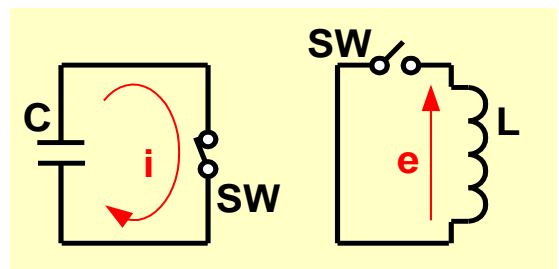

Figure-2 Discharge of the energy

● **The generation of back electromotive force**

As explained above, if a current is interrupted for a moment by a switch or a transistor during supplying current through a coil, very high voltage is generated on the both ends of coil to try to keep supplying the current through the coil.

There is a way to generate a high voltage by using this phenomenon. However, in the case of the circuit which current through coil is ON-OFF, other studies will be necessary such as a protection circuit for high voltage.

Attention must be paid in the case like putting a choke coil in a power supply for noise control during prototype study as the similar situation may happen.

● **Frequency characteristics**

For both coil and capacitor, their impedance and electrical characteristics change depending on frequency. If we think the frequency characteristic of coil in a circuit in a contrast with capacitor, based on **Table-1** following circuits show similar frequency characteristics (refer to Figure-3):

"**Capacitor** put on a circuit **in series** (parallel)" = "**Coil** put on a circuit **in parallel** (serial)"

However, it must be considered that the fundamental operation is different.

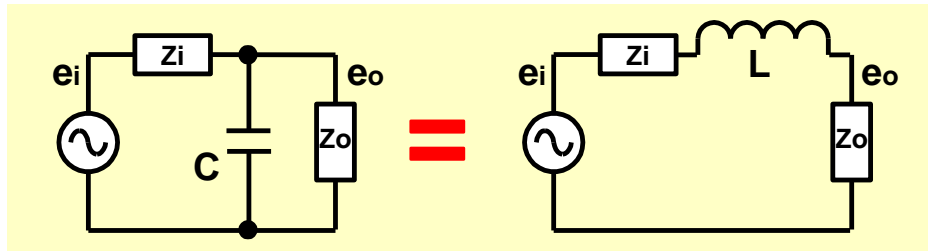

Fig-3 Parallel C and Series L

● **Failure mode of coil**

For wire wound coil, there are various causes of failures, and the most major failure mode is "disconnection (open circuit)".

Besides, when a coil is used under bad condition, short circuit may occur between wires due to insulation degradation of wire coating.

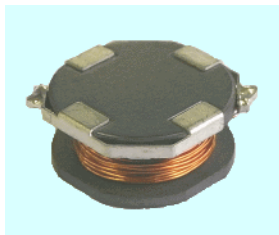

Photo-2 CWD1242C

In the case of the disconnection, a coil becomes open, and a current is interrupted.

The damage is smaller than the one becoming short circuit in the most cases, however the disconnection may have a great impact to other components. In mechanical failure, there is a cause "removed solder section between a coil terminal and circuit board", which occurs in the case like vibration is applied continuously.

If a device which our coil is put requires high reliability and safety against failure, attention must be paid to such failure modes as well as selecting the coil which reliability was fully studied.

Photo-1 & -2 (Photo-2 shows bottom side of product) show our **CWD·CWR series** developed for automotive application. These have 4 terminals structure to ensure high resistance to impact and vibration.

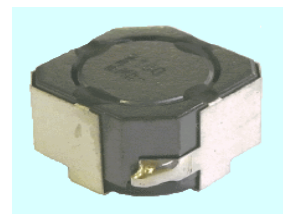

Photo-1 CWR1277C

※CWR1277C,CWD1242C This product is not currently in the lineup.

●If impact is made to coil

It often happens that a component is dropped to a floor accidentally, and the impact is made to it. If a floor is hard like a concrete, the impact reaches **1,000G** although it is short time (several **mill seconds**).

Ferrite core is used for many of coil as magnetic materials. If big impact is made, it may be damaged same as ceramics (china).

We think that nobody uses the coil which dropped and damaged on the appearance. Even if there is no damage in an appearance, the inside of a ferrite core may have cracked with the impact. We strongly recommended not using the dropped coil.

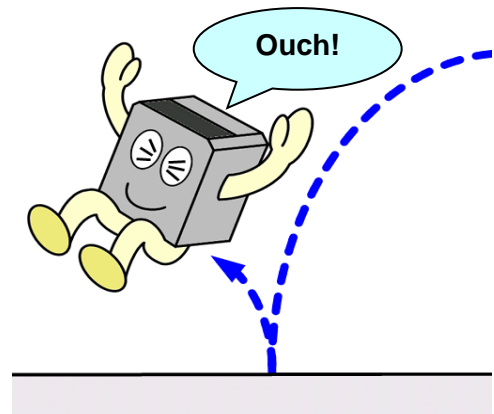

Any impact damages coil!

●In closing



We could complete **total 12 topics of the first series**. We appreciate that a lot of people have read them than expected. Thank you very much. We hope it will be useful for your work as much as possible.

●Author

Yasuo Hoshino, born in 1954, is a prominent coil specialist at SAGAMI ELEC CO., LTD.

He joined Sagami Musen Works, a former company of SAGAMI ELEC, in 1976 and has been working in the engineering department for over 40 years. During his career at Sagami, he has served as a technical manager and a member in board. Even to this day, he continues to devote himself to support the company as an advisor and guide and train the staffs. He is well known for his easy-to-understand technical explanations. His hobby is taking photos.

Notes

While we pay sufficient attention to this description in preparing this, if you have any questions or doubts in this description, please contact following address.

e-mail: sales@sagami-elec.co.jp





SAGAMI ELEC CO., LTD.