

SERVICE MANUAL

PARTS LIST

RTV servis Horvat

Kešinci, 31402 Semeljci

Tel : 031-856-637

Tel / fax : 031-856-139

Mob : 098-788-319

rtv-servis-horvat@os.tel.hr

MODEL AM-2600

AKAT

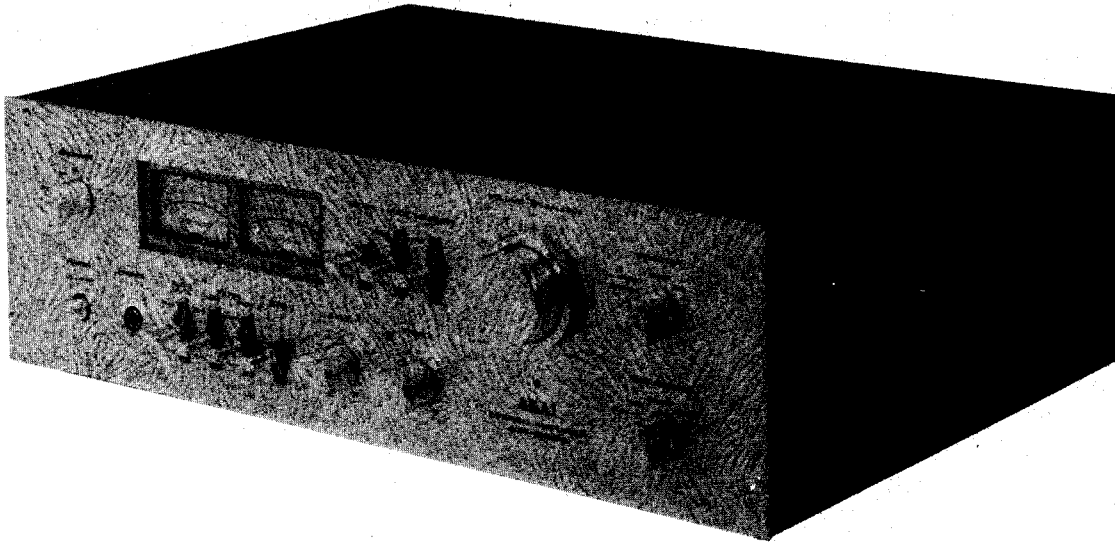

AKAI STEREO INTEGRATED AMPLIFIER

MODEL AM-2600

SECTION 1 SERVICE MANUAL	1
SECTION 2 PARTS LIST	15
SECTION 3 SCHEMATIC DIAGRAM	24

SECTION 1

SERVICE MANUAL

TABLE OF CONTENTS

I.	TECHNICAL DATA	2
II.	DISMANTLING OF UNIT	3
III.	CONTROLS	4
IV.	PRINCIPAL PARTS LOCATION	5
V.	LEVEL DIAGRAM	6
VI.	MAIN AMPLIFIER ADJUSTMENT	7
	1. IDLING CURRENT ADJUSTMENT	7
	2. LEVEL METER ADJUSTMENT	7
VII.	CLASSIFICATION OF VARIOUS P.C BOARDS	8
	1. RELATION OF P.C BOARD TITLE AND IDENTIFICATION NUMBER	8
	2. COMPOSITION OF VARIOUS P.C BOARDS	9

For basic adjustments, measuring methods, and operating principles, refer to GENERAL OPERATING PRINCIPLES AND ADJUSTMENTS.

I . TECHNICAL DATA

POWER AMPLIFIER SECTION

CONTINUOUS POWER OUTPUT 2-CHANNELS DRIVEN	60 watts per channel, minimum RMS, at 8 ohms from 20 to 20,000 Hz with no more than 0.1% total harmonic distortion.
POWER BANDWIDTH (IHF)	7 Hz to 40 kHz/8 ohms (Total Harmonic Distortion: 0.1%)
SIGNAL TO NOISE RATIO (IHF)	
PHONO	Better than 75 dB
AUX	Better than 95 dB
RESIDUAL NOISE	Less than 0.5 mV at 8 ohms
CHANNEL SEPARATION (IHF)	
PHONO	Better than 55 dB at 1,000 Hz
DAMPING FACTOR	More than 60 (1 kHz, 8 ohms)
OUTPUT	
SPEAKERS	A, B (4 to 16 ohms)/A+B (8 to 16 ohms)
HEADPHONE	4 to 16 ohms
POWER INDICATOR METERS	(2) 3/80W switchable

PREAMPLIFIER SECTION

INPUT SENSITIVITY/IMPEDANCE	
PHONO	Phono 2: 3 mV/33, 47 or 100 k ohms Phono 1: 3 mV/50 k ohms
AUX	150 mV/100 k ohms
TUNER	150 mV/100 k ohms
TAPE MONITOR	PIN: 150 mV/100 k ohms DIN: 150 mV/100 k ohms
OUTPUT LEVEL/IMPEDANCE	
TAPE REC	PIN: 150 mV/100 k ohms DIN: 30 mV/180 k ohms
FREQUENCY RESPONSE	
PHONO (RIAA EQUALIZATION)	30 Hz to 15 kHz +0.8 dB, -0.8 dB
TUNER, AUX, TAPE MONITOR	7 Hz to 70 kHz +0 dB, -1 dB
TONE CONTROL	
BASS	±9 dB at 100 Hz
TREBLE	±9 dB at 10 kHz
LOUDNESS CONTROL	+10 dB at 100 Hz, +6 dB at 10 kHz (High Position) +10 dB at 100 Hz (Low Position) (Volume Control set at -30 dB position)
FILTER	
HIGH	-5 dB at 7 kHz (7 kHz position) -3 dB at 10 kHz (10 kHz position)
LOW	-2 dB at 50 Hz (30 Hz position) -6 dB at 50 Hz (60 Hz position)

MISCELLANEOUS

SEMICONDUCTORS	Transistors: 35 Diodes: 17
POWER REQUIREMENTS	CSA, UL and LA models: 120V, 60 Hz CEE models: 220V, 50 Hz Other models: 110/220/240V, 50/60 Hz switchable
DIMENSIONS	440(W) x 141(H) x 331(D)mm, (17.3 x 5.6 x 13 inches)
WEIGHT	10 kg (22 lbs)

* For improvement purposes, specifications and design are subject to change without notice.

II. DISMANTLING OF UNIT

In case of trouble, etc. necessitating disassembly, please disassemble in the order shown in photographs. Reassemble in reverse order.

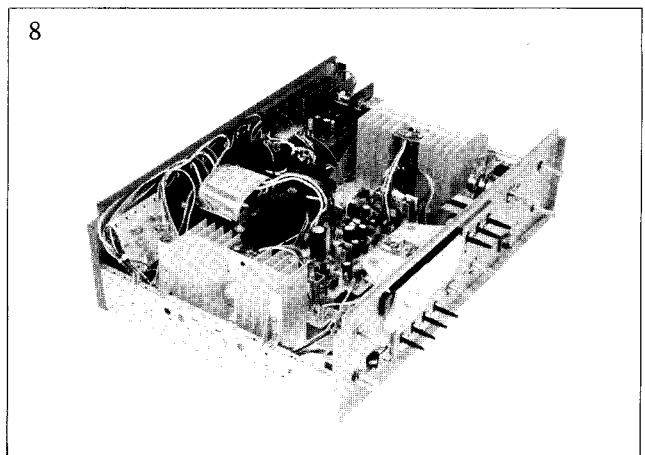
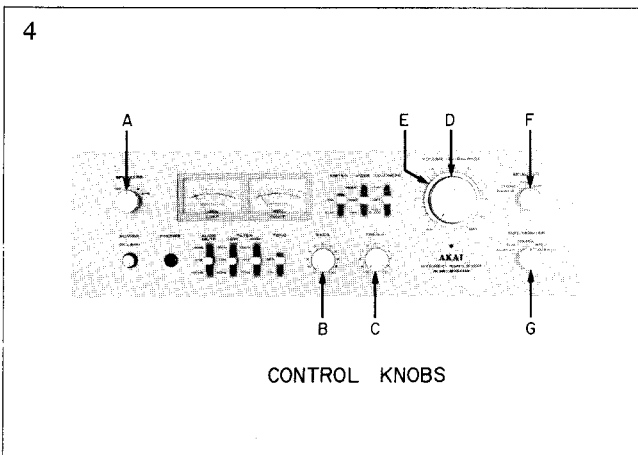
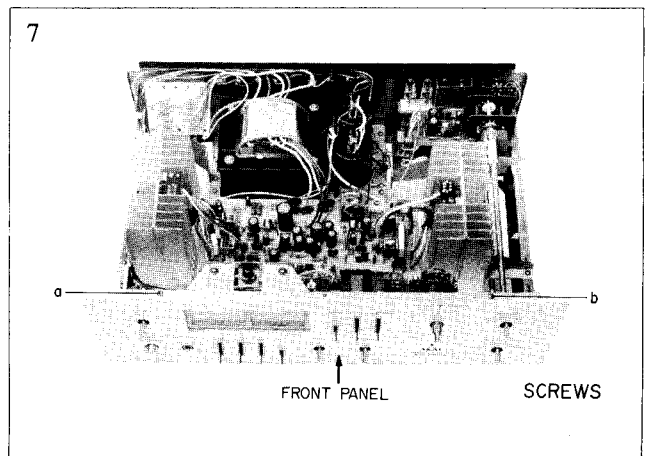
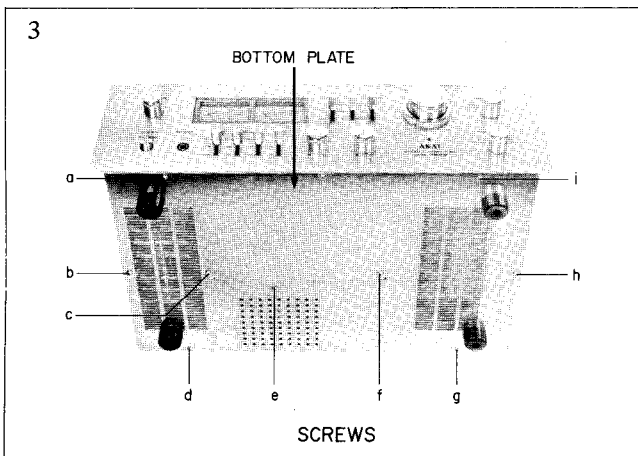
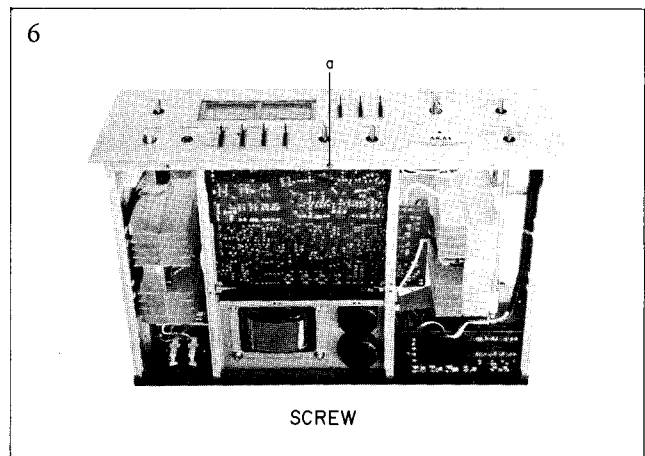
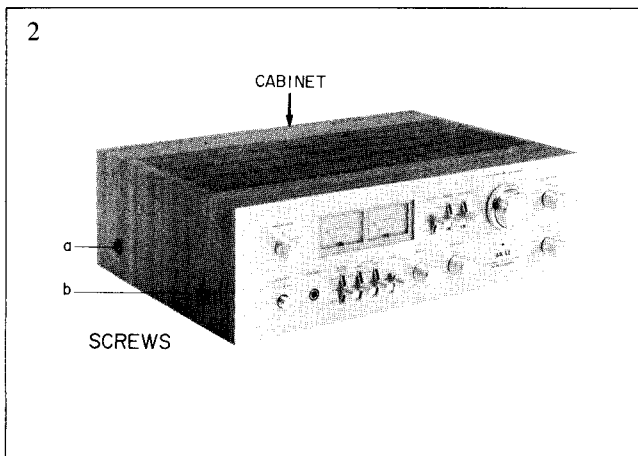
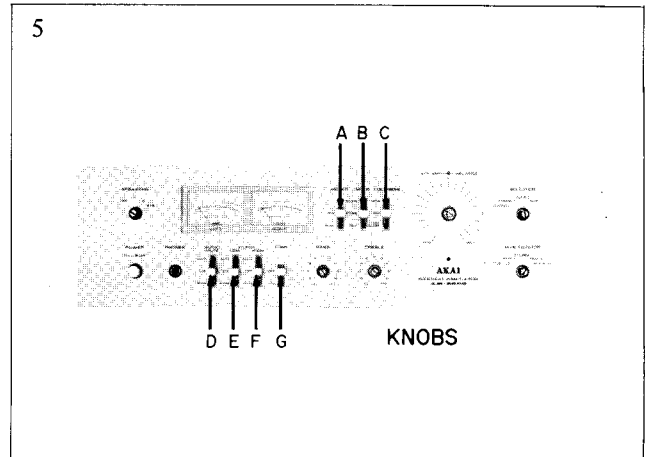
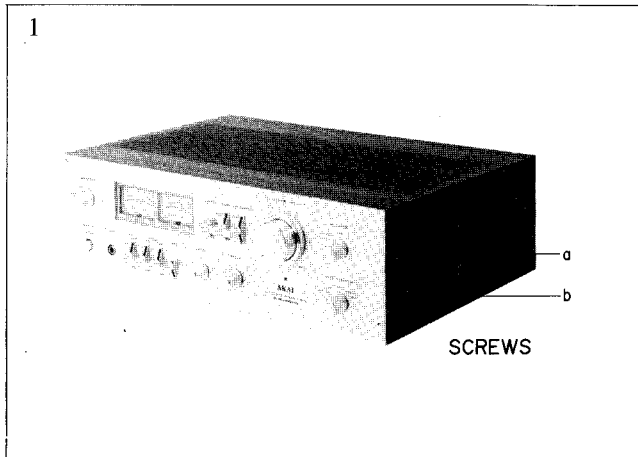

III. CONTROLS

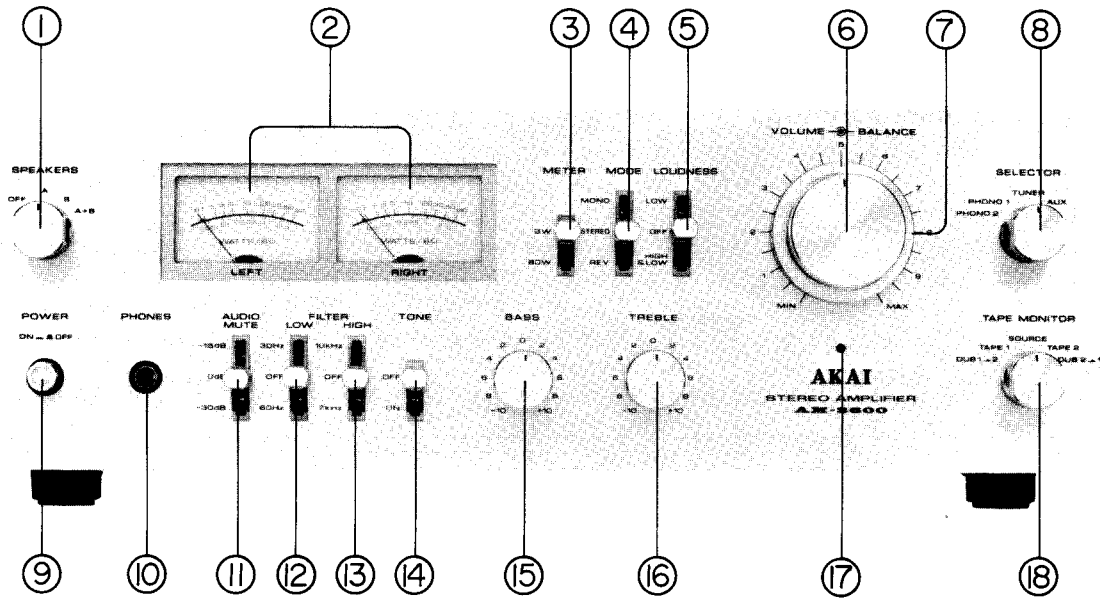

Fig. 1 Controls

- | | |
|--|--------------------------|
| 1. SPEAKER SYSTEM SELECTOR | 10. HEADPHONE JACK |
| 2. OUTPUT POWER LEVEL METERS
(Left and Right) | 11. AUDIO MUTE SWITCH |
| 3. METER SWITCH | 12. LOW FILTER SWITCH |
| 4. MODE SWITCH | 13. HIGH FILTER SWITCH |
| 5. LOUDNESS SWITCH | 14. TONE SWITCH |
| 6. VOLUME CONTROL | 15. BASS TONE CONTROL |
| 7. STEREO BALANCE CONTROL | 16. TREBLE TONE CONTROL |
| 8. INPUT SELECTOR | 17. POWER INDICATOR LAMP |
| 9. POWER SWITCH | 18. TAPE MONITOR SWITCH |

IV. PRINCIPAL PARTS LOCATION

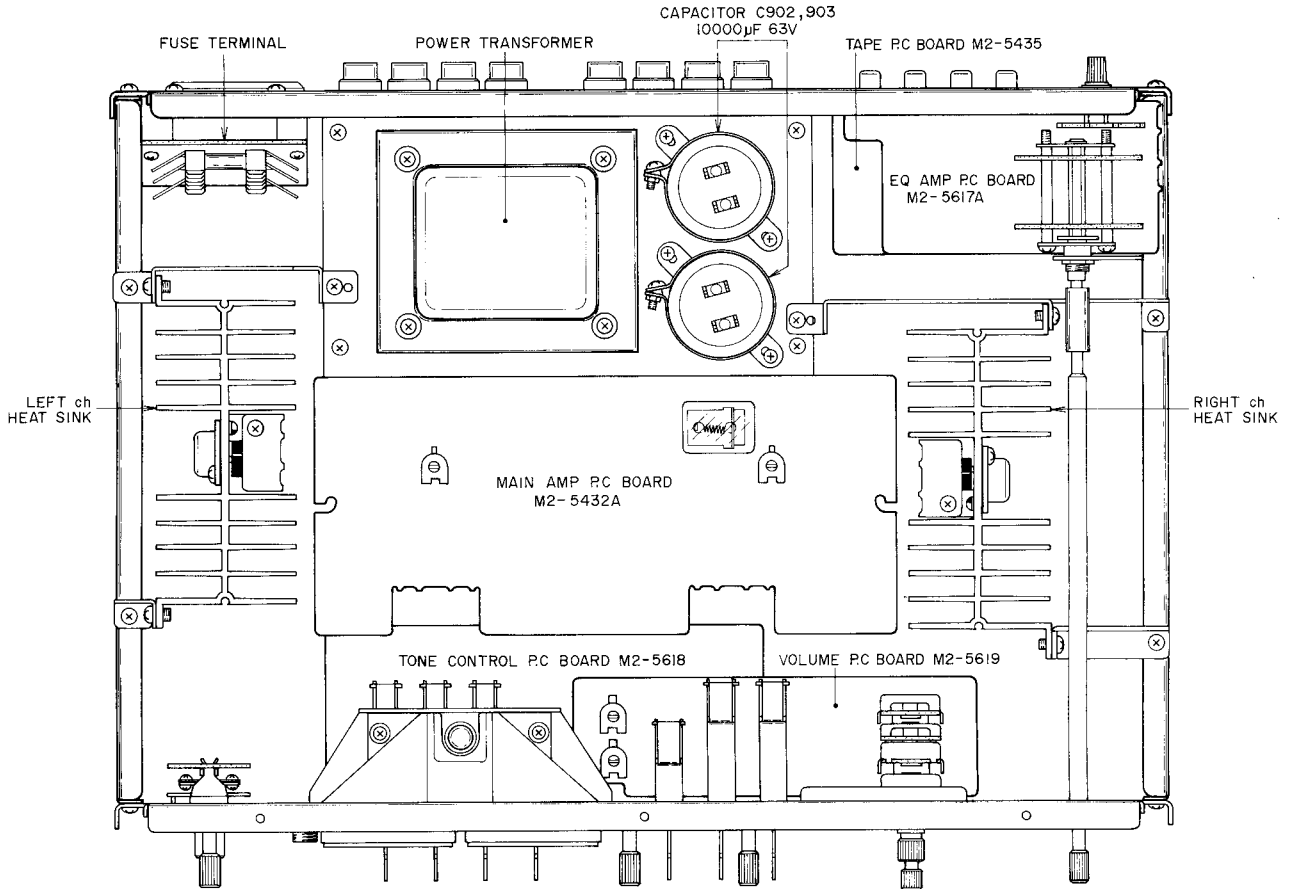

Fig. 2 Top View

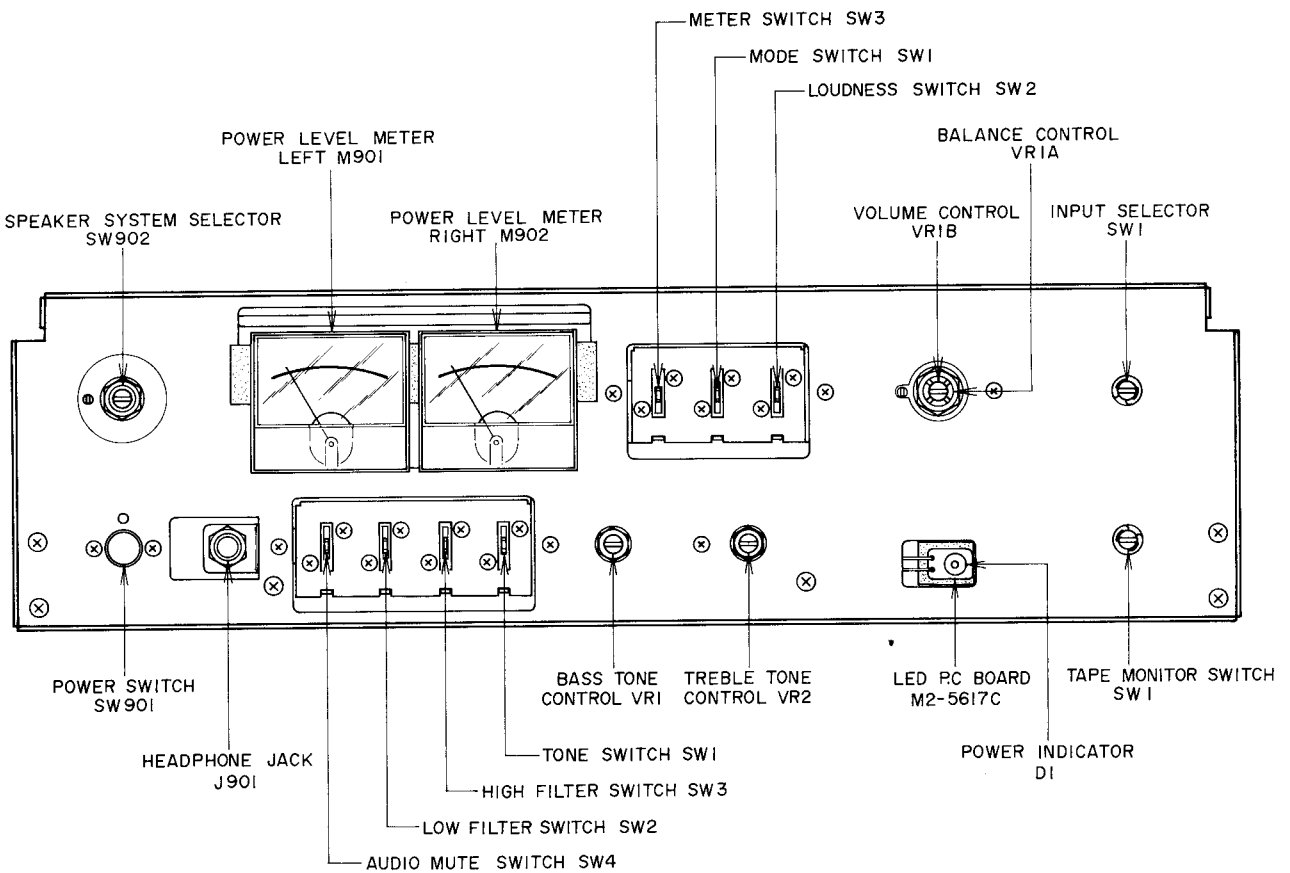

Fig. 3 Front View

V. LEVEL DIAGRAM

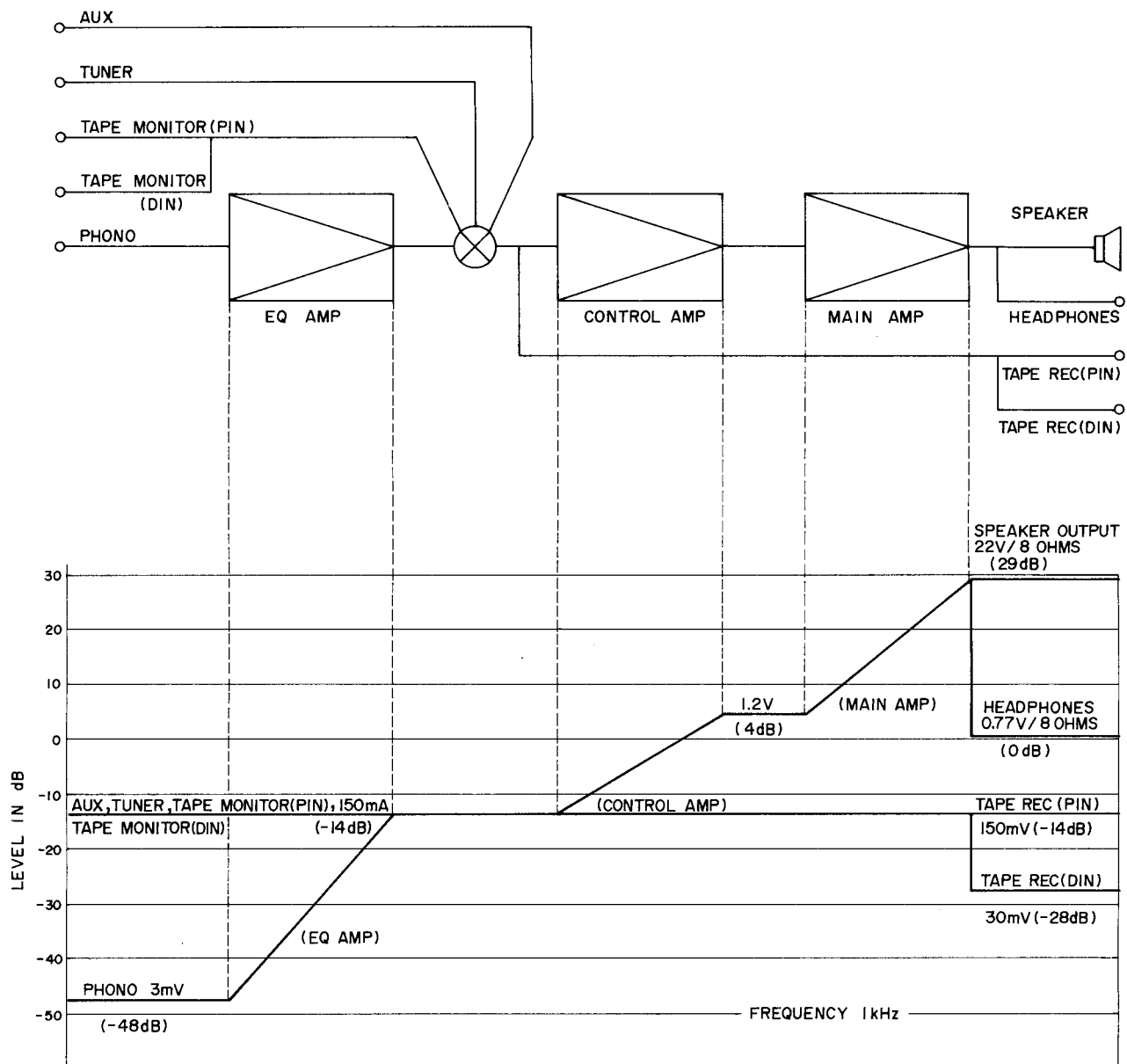

Fig. 4 Level Diagram of Model AM-2600

VI. MAIN AMPLIFIER ADJUSTMENT

1. IDLING CURRENT ADJUSTMENT

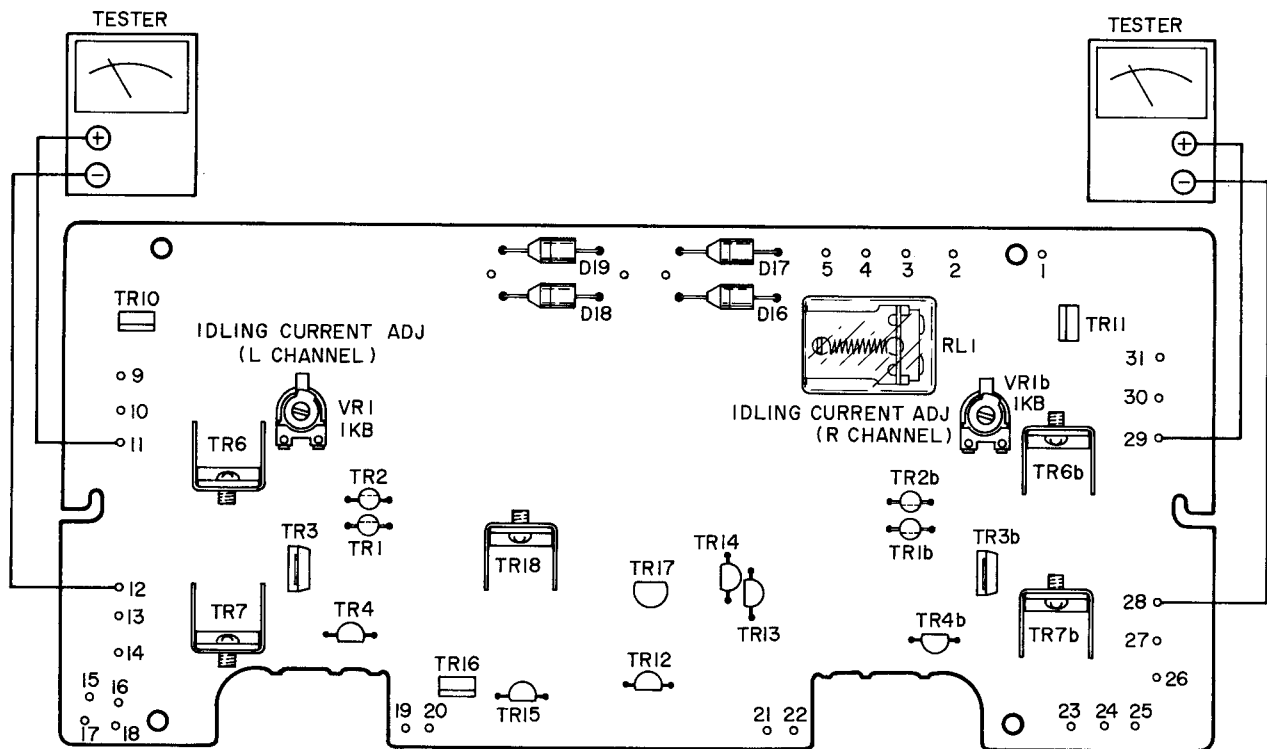

Fig. 5 Main Amp. P.C Board M2-5432A

Connect a tester to Power Amp. P.C Board test point between Pin-11 and Pin-12, and between Pin-29 and Pin-28.

Adjust semi-fixed resistors VR-1a, VR-1b until the voltage is 30 mV.

2. LEVEL METER ADJUSTMENT

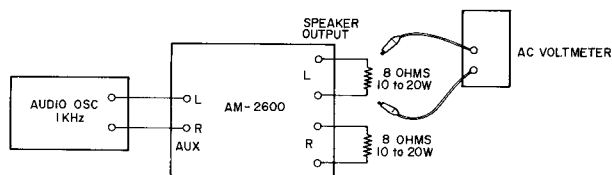

Fig. 6 Level Meter Adjustment

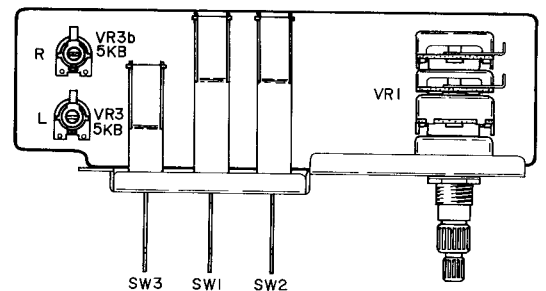

Fig. 7 Volume P.C Board M2-5619

- Connect instruments as shown in Fig. 6.
- Turn volume control knob on the front panel until the AC voltmeter indicates 4.9 volts (3 watts).
- Adjust VR-3a,b so that level-meter indicates 3 watts. (Refer to Fig. 7)

VII. CLASSIFICATION OF VARIOUS P.C BOARDS

1. RELATION OF P.C BOARD TITLE AND IDENTIFICATION NUMBER

P.C Board Title	P.C Board Number
Main Amplifier P.C Board	M2-5432
Tone Control P.C Board	M2-5618
Equalizer P.C Board	M2-5617
Volume P.C Board	M2-5619
Tape P.C Board	M2-5435

Chart-1

2. COMPOSITION OF VARIOUS P.C BOARDS

1) MAIN AMPLIFIER P.C BOARD M2-5432 2ED

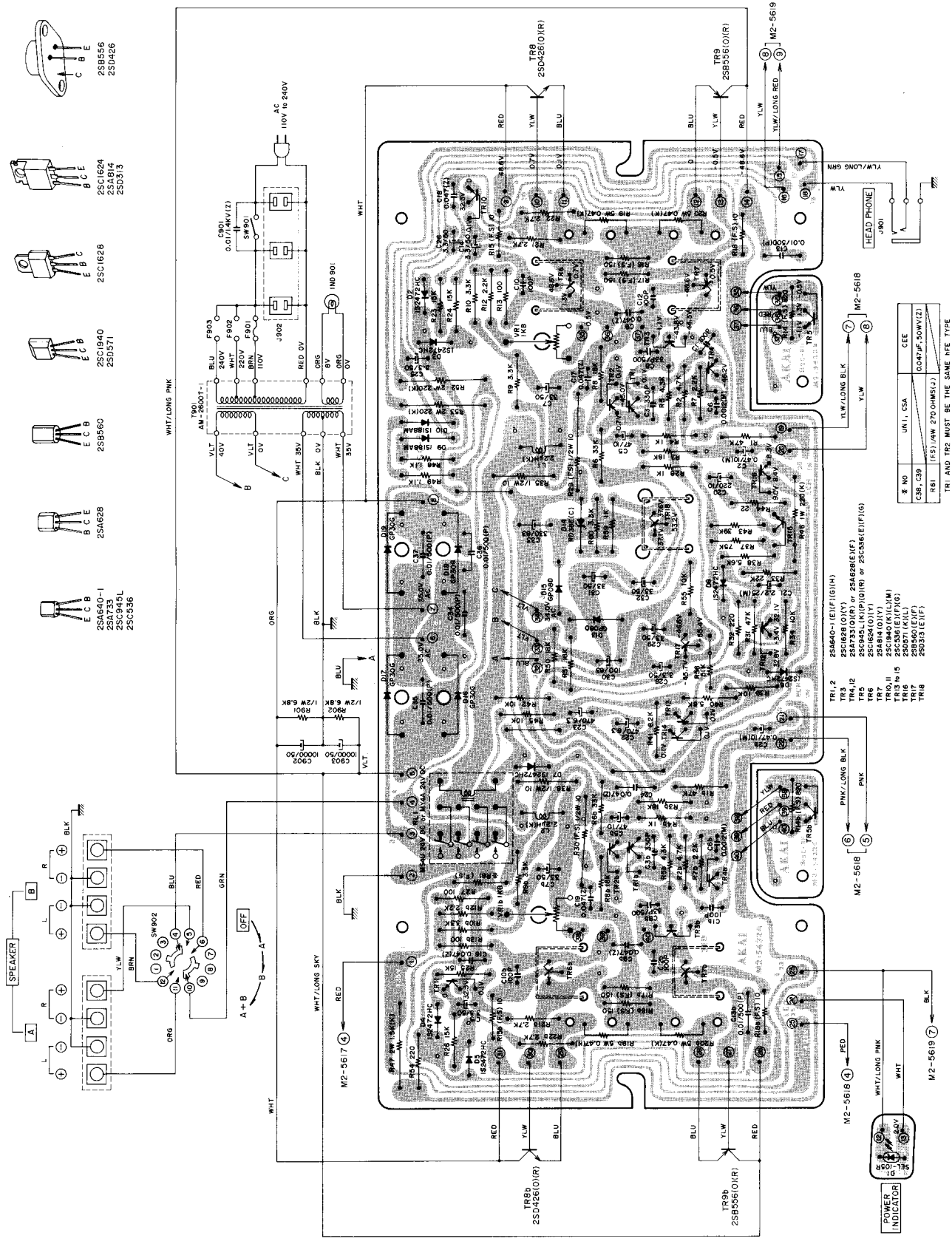

2) TONE CONTROL P.C BOARD M2-5618

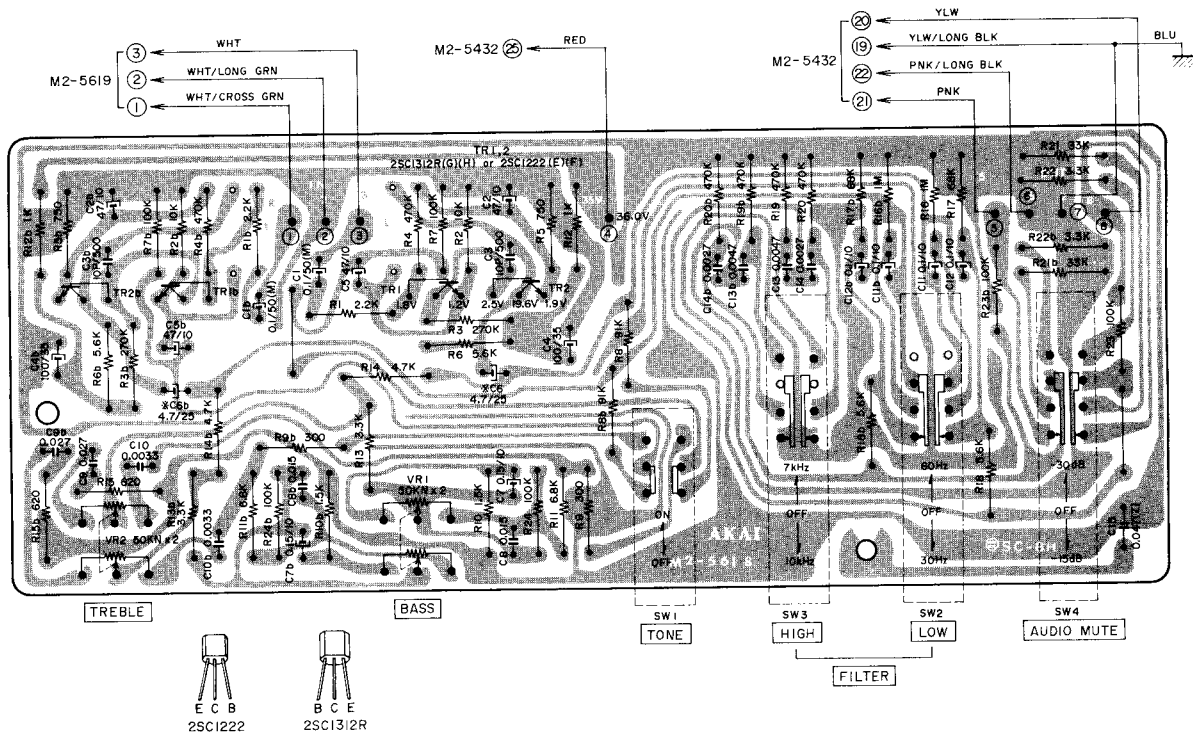

3) EQUALIZER P.C BOARD M2-5617

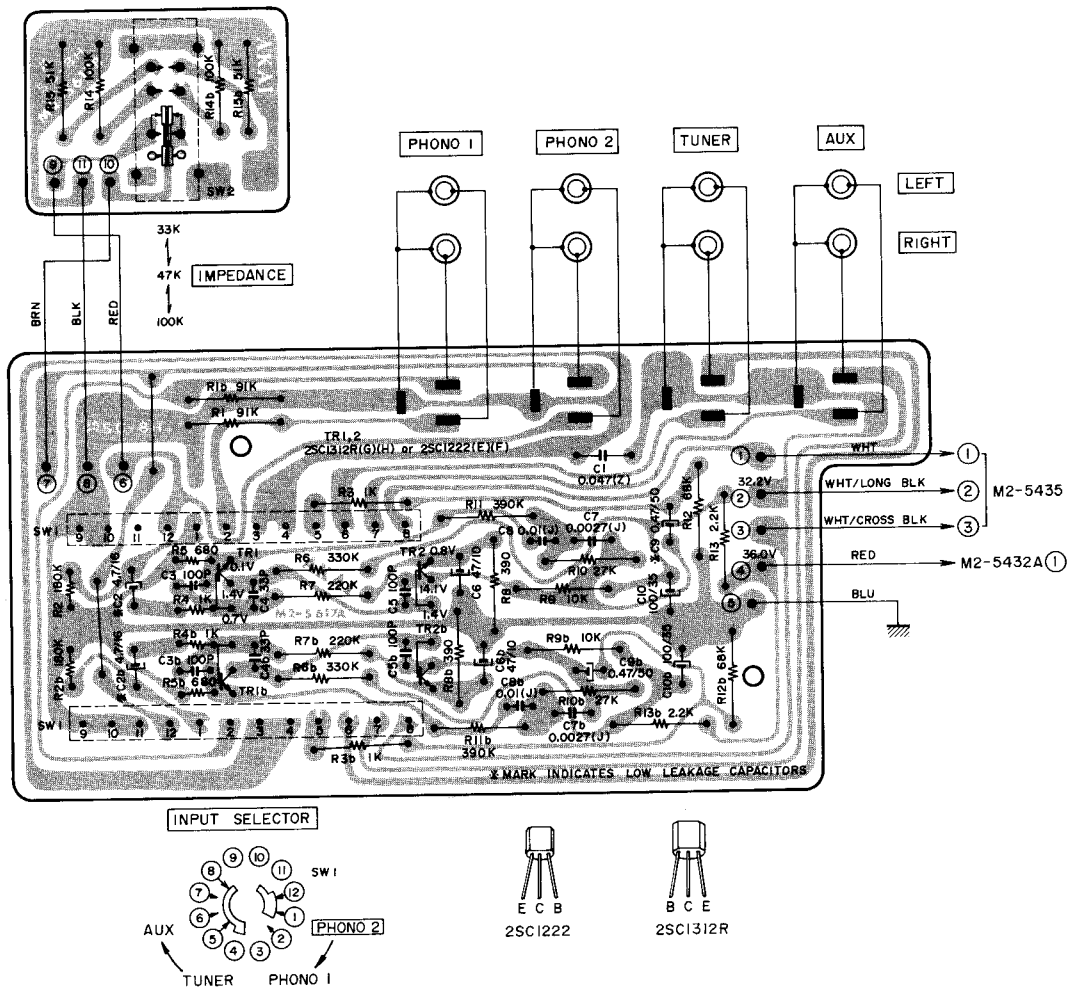

4) VOLUME P.C BOARD M2-5619

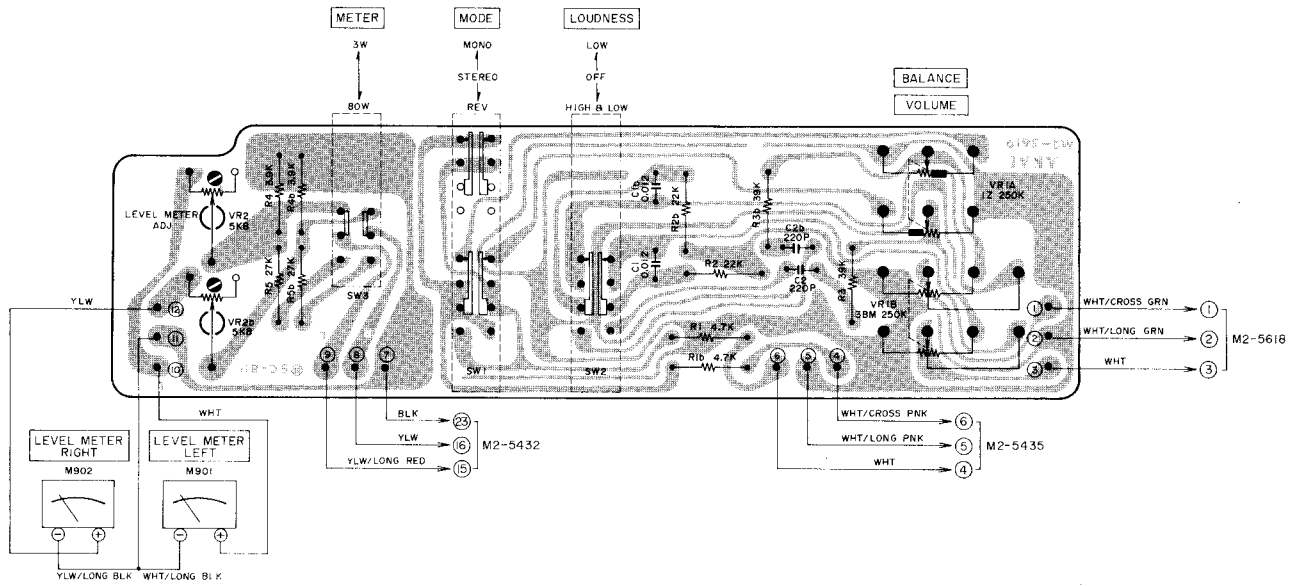

5) TAPE P.C BOARD M2-5435

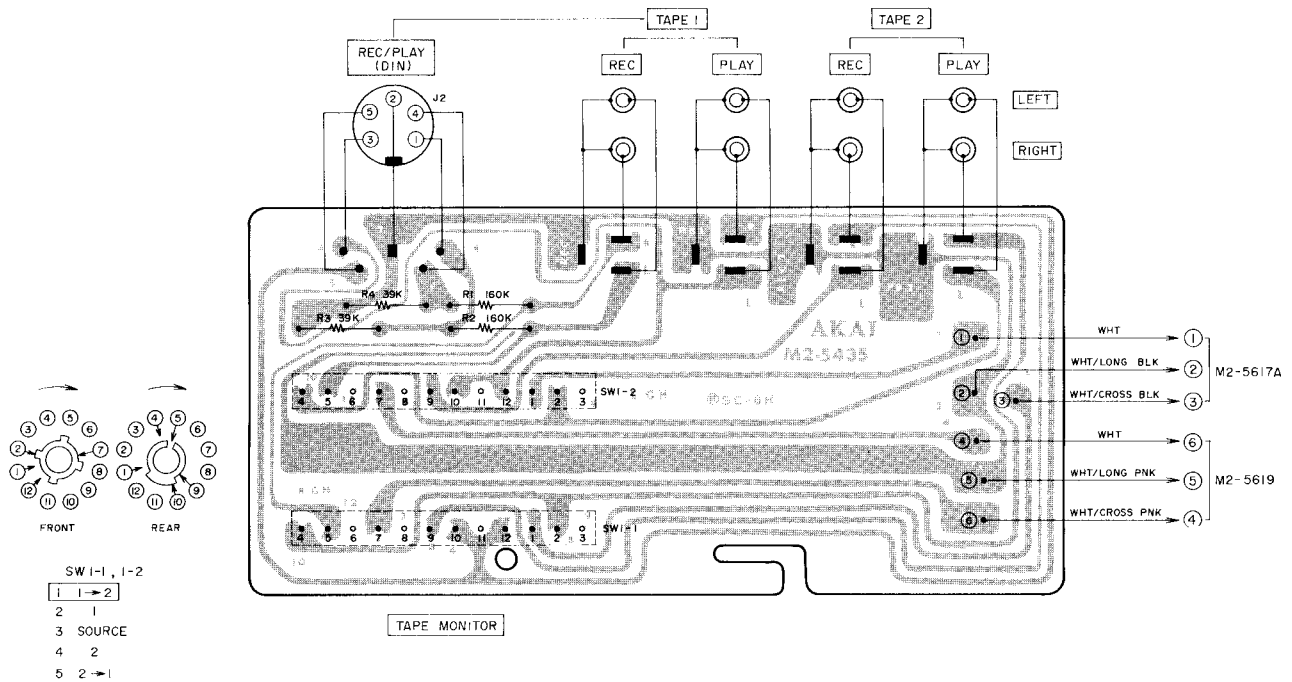

SECTION 2

PARTS LIST

TABLE OF CONTENTS

1. RECOMMENDED SPARE PARTS LIST	17
2. MAIN AMP P.C BOARD (M2-5432A) BLOCK	18
3. TONE CONTROL P.C BOARD (M2-5618) BLOCK	18
4. EQ. P.C BOARD (M2-5617A, M2-5617B) BLOCK	19
5. VOL. P.C BOARD (M2-5619) BLOCK	19
6. TAPE P.C BOARD (M2-5435) BLOCK	19
7. TEMP. COMPENSATION P.C BOARD (M2-5432C) BLOCK	19
8. LED P.C BOARD (M2-5617C) BLOCK	19
9. ASSEMBLY BLOCK	20
10. FINAL ASSEMBLY BLOCK	22
11. LIST OF INTERCHANGEABLE SEMICONDUCTORS	23
INDEX	24

Resistor and Capacitor which is not listed in this parts list, please refer to
COMMON LIST FOR SERVICE PARTS.

HOW TO USE THIS PARTS LIST

1. This parts list is compiled by various individual blocks based on assembly process.
2. When ordering parts, please describe parts number, serial number, and model number in detail.
3. How to read list.

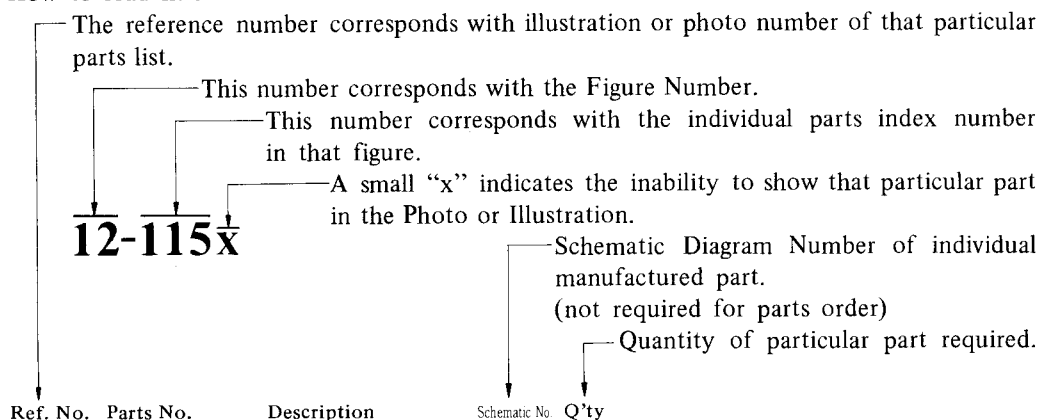

FLYWHEEL BLOCK #13				
Ref. No.	Parts No.	Description	Schematic No.	Q'ty
12-115x	800425	Flywheel Block Assy. Comp.	RDG #13	1
12-116	244506	Flywheel Only	RD-233	1
12-117x	244754	Felt, Flywheel	RD-275	1
12-118	251324	Main Metal Case	RD-236	1
12-119	253080	Main Metal	RD-237	1

4. The symbol numbers shown on the P.C. Board list can be matched with the Composite Views of components of the Schematic Diagram or Service Manual.
5. The indications of Resistors and Capacitors in the photos of P.C. Board are being eliminated.
6. The shape of the parts and parts name, etc. can be confirmed by comparing them with the parts shown on the Electrical Parts Table of P.C. Board.
7. Both the kind of part and installation position can be determined by the Parts Number. To determine where a parts number is listed, utilize Parts Index at end of Parts List.
It is necessary first of all to find the Parts Number. This can be accomplished by using the Reference Number listed at right of parts number in the Parts Index. (meaning of ref. no. outlined in Item 3 above).
8. Utilize separate "Price List for Parts" to determine unit price. The most simple method of finding parts Price is to utilize the reference number.

CAUTION:

1. When placing an order for parts, be sure to list the parts no. model no., and description. There are instances in which if any of this information is omitted, parts cannot be shipped or the wrong parts will be delivered.
2. Please be careful not to make a mistake in the parts no. If the parts no. is in error, a part different from the one ordered may be delivered.
3. Because parts number and parts unit supply in the Preliminary Service Manual (Basic Parts List) may be partially changed, please use this parts list for all future reference.

1. RECOMMENDED SPARE PARTS LIST

Because, if the parts listed below are on hand, almost any repair can be accomplished, we suggest that you stock these Recommended Spare Parts Items.

Parts No.	Description	Note
BA235877	Tape P.C Board Comp. M2-5435	
BA235980	Tone Control P.C Board Comp. M2-5618	
BA236002	Volume P.C Board Comp. M2-5619	
BA236035	Main Amplifier P.C Board Comp. M2-5432	
BA236103	Equalizer P.C Board Comp. M2-5617	
BC241751	Cabinet	Same as AM-2400
BD235967	Front Panel Block Comp. AM-2600	
BT240658	Power Transformer AM-2600T-1	T901
EL245700	Lamp 8V 300 mA (600m/mx2)	IND901
EM240592	Level Meter D18B14R	M901, 902
EP245283	Relay MY4A 24VDC	RL1
EP245305	Relay MS4U 24VDC	RL1
ES214650	Lever Switch SX15-1	Same as AM-2400
ES240524	Rotary Switch SR321N 1-2-4 30 KC	
ES243674	Lever Switch SX153-1	Same as AM-2400
ES246183	Lever Switch SX153-3	
ES246194	Rotary Switch SR26N 2-4-4 20 KC	
ET655648	Transistor 2SD426(O)(R)	TR8
ET655650	Transistor 2SB556(O)(R)	TR9
EV242267	Volume V16L4G3N 50kx2	VR1, 2
SK224886	Power Knob	
SK233730	Lever Knob	
SK240063	Selector Knob	Same as AM-2400
SK241863	Volume Knob	
SK241874	Balance Knob	
SK646817	Single Knob	Same as AM-2400

2. MAIN AMP P.C BOARD (M2-5432A) BLOCK

Symbol No.	Parts No.	Description	Schematic Q'ty No.
2-1	BA236035	Main Amp P.C Board Comp. (M2-5432A)	1
2-2	BA270426	Main Amp P.C Board Comp. (M2-5432A)(CEE)	1
2-TR1,2	ET204221	Transistor 2SA640-1(E) (F)(G)(H)	45-1-168 4
2-TR3	ET623035	Transistor 2SC1628(O)(Y)	45-1-200 2
2-TR4	ET557965	Transistor 2SA733(Q)(R)	45-1-124 2
2-TR6	ET623046	Transistor 2SC1624(O)(Y)	45-1-190 2
2-TR7	ET623057	Transistor 2SA814(O)(Y)	45-1-187 2
2-TR10, 11	ET240636	Transistor 2SC1940(K) (L)(M)	45-1-241 2
2-TR12	ET557965	Transistor 2SA733(Q)(R)	45-1-124 1
2-TR13 to 15	ET520841	Transistor 2SC711(E) (F)(G)	45-1-67 3
2-TR16	ET666404	Transistor 2SD571(K)(L)	45-1-218 1
2-TR17	ET219868	Transistor 2SB560(E)(F)	45-1-232 1
2-TR18	ET452531	Transistor 2SD313(E)(F)	45-1-105 1
2-D2to8	ED214457	Silicon Diode 1S2472	45-3-41 7
2-D9,10	ED562386	Germanium Diode 1S188AM	45-3-24 2
2-D13	ED245430	Silicon Diode GP08D	45-2-68 1
2-D14	ED240377	Zener Diode RD36E(C)	45-6-72 1
2-D15	ED245430	Silicon Diode GP08D	45-2-68 1
2-D16 to 19	ED245428	Silicon Diode GP30G	45-2-69 4
2-RL1	EP245283	Relay MY4A 24VDC	47-1-29 1
2-VR1	EV484863	Semi-fixed/Vol. V10K8-4-2 1 kB	36-10-250 2
2-L1,2	EO650823	Phase Compensation Coil 2.2μH(K)	23-1-239 2
2-R19, 20	ER622978	Metal Plate/R. MPC71F1 5W 0.47 ohm(K)	35-16-48 4
2-R46	ER389687	Metal Oxide Film/R. 1W 220 ohms(K)	35-15-10 1
2-R47	ER245531	Metal Oxide Film/R. 2W 1.5k(K)	35-15-8 1
2-R52, 53	ER246363	Metal Oxide Film/R. 2W 220 ohms(K)	35-15-18 2
2-C2	EC538244	Solid Aluminum/C. 0.47μF(M) 10WV (Vert. Type)	24-19-2 2
2-C21	EC662128	Solid Aluminum/C. 2.2μF(M) 25WV (Vert. Type)	24-19-2 1
2-C33	EC239073	Elect./C. 330μF 63WV (Vert. Type)	24-12-16 1
2-C34 to 37	EC204671	Ceramic/C. DD31-6 0.01μF(P) 500WV	24-5-66 4
2-3	ZS463353	Tapping Screw #2 3x8(BR)	6

3. TONE CONTROL P.C BOARD (M2-5618) BLOCK

Symbol No.	Parts No.	Description	Schematic Q'ty No.
3-1	BA235980	Tone Control P.C Board Comp. (M2-5618)	1
3-TR1,2	ET459810	Transistor 2SC1222(E)(F)	45-1-110 4
3-VR1,2	EV242267	Single axial 2 throw Vol. V16L4G3N 50kx2	36-22-19 2
3-SW1	ES214650	Lever SW. SX15-1	25-12-38 1
3-SW2	ES243674	Lever SW. SX153-1	25-12-31 3
3-C7	EC243371	Solid Aluminum/C. 0.15μF(K) 10WV (Vert. Type)	24-19-2 2
3-C11,12	EC246767	Solid Aluminum/C. 0.1μF(K) 10WV (Vert. Type)	24-19-2 4
3-2	ZS417216	Screw, pan head 3x4	8

4. EQ. P.C BOARD (M2-5617A, M2-5617B) BLOCK

Symbol No.	Parts No.	Description	Schematic No.	Q'ty
4-1	BA236103	EQ. P.C Board A Comp. (M2-5617A)		1
4-TR1,2	ET459810	Transistor 2SC1222(E)(F)	45-1-110	4
4-SW1	ES246194	Rotary SW. SR26N 2-4-4 20 KC	25-6-97	1
4-J1	EJ246216	8P Pin Jack	31-1-188	1
4-2	BA236147	EQ. P.C Board B Comp. (M2-5617B)		1
4-SW2	ES246227	Slide SW. SSC323E	25-3-119	1

5. VOL. P.C BOARD (M2-5619) BLOCK

Symbol No.	Parts No.	Description	Schematic No.	Q'ty
5-1	BA236002	Vol. P.C Board Comp. (M2-5619)		1
5-VR1	EV246148	Double/Vol. 1Z250kx2 3BM250kx2	36-3-72	1
5-SW1	ES246183	Lever SW. SX153-3	25-12-32	1
5-SW2	ES243674	Lever SW. SX153-1	25-12-31	1
5-SW3	ES214650	Lever SW. SX15-1	25-12-38	1
5-2	ZS417216	Screw, pan head 3x4		6

6. TAPE P.C BOARD (M2-5435) BLOCK

Symbol No.	Parts No.	Description	Schematic No.	Q'ty
6-1	BA235877	Tape P.C Board Comp. (M2-5435)		1
6-J1	EJ246216	8P Pin Jack	31-1-188	1
6-J2	EJ698051	Din Jack	31-1-158	1
6-SW1	ES245733	Rotary SW. SR26N 1-2-5 20 KC	25-6-98	1

7. TEMP. COMPENSATION P.C BOARD (M2-5432C) BLOCK

Symbol No.	Parts No.	Description	Schematic No.	Q'ty
7-1	EA245698	Temp. Compensation P.C Board C	M2-5432C	1
7-TR5	ET635218	Transistor 2SC945L(K) (P)(Q)(R)	45-1-85	1

8. LED P.C BOARD (M2-5617C) BLOCK

Symbol No.	Parts No.	Description	Schematic No.	Q'ty
8-1	EA241986	LED P.C Board	M2-5617C	1
8-D1	ED656357	LED SEL-105R	45-15-11	1

9. ILLUSTRATION OF ASSEMBLY BLOCK

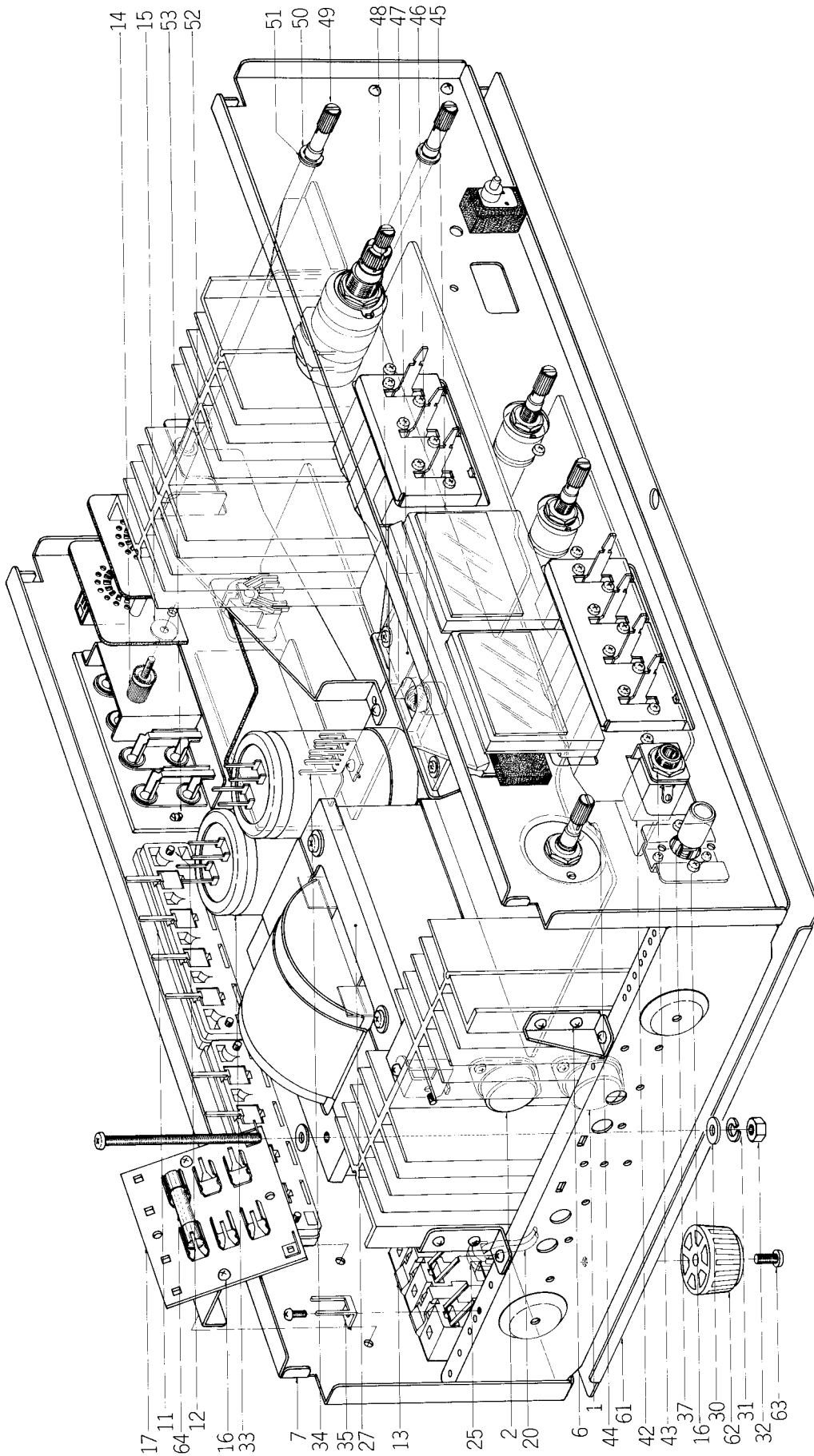

9) ASSEMBLY BLOCK

Ref. No.	Parts No.	Description	Schematic No.	Q'ty	Ref. No.	Parts No.	Description	Schematic No.	Q'ty
HEAT-SINK BLOCK									
9-1	ET655648	Transistor 2SD426(O)(Y)	45-1-221	2	9-52	TA646773	Joint	AA-5240	2
9-2	ET655650	Transistor 2SB556(O)(Y)	45-1-222	2	9-53	ZW698308	Nylon Rivet (FNPR) 3x5.5 Black	2-7-54	5
9-3x	EJ624486	Power TR. Socket	31-1-97	4	9-54x	ZS608185	Screw, pan head 2.6x4		1
9-4x	EZ624734	Mylar Sheet AC-201	45-16-18	4	9-55x	ZW330412	Adjust. Washer (U) D4x13x 0.13t		2
9-5x	ZS417148	Screw, binding head 3x15		8	9-56x	ZW330423	Adjust. Washer (U) D4x13x 0.25t		2
9-6	ZS447840	Tapping Screw #2 3x8 (BR)		22	9-57x	ZW330434	Adjust. Washer (U) D4x13x 0.5t		2
REAR PANEL BLOCK									
9-7	SP241931	Rear Panel 1	M2-5606	1	9-58x	ZW330445	Adjust. Washer (U) D4x13x 0.8t		2
9-8x	SP240546	Rear Panel 3 (CEE, VDE)	M2-5607	1	9-59x	ZW330456	Adjust. Washer (U) D4x13x1t		2
9-9x	SP241942	Rear Panel 2 (CSA)	M2-5606	1	9-60x	ZW439547	Adjust. Washer (U) D4x13x 1.5t		2
9-10x	SP240478	Rear Panel 4 (BEAB)	M2-5607	1	9-61	SP233684	Bottom Plate A	M2-5245	1
9-11	EJ240581	4P Push Terminal	32-1-72	2	9-62	SZ645243	Circular Foot A CA	CA-6014	4
9-12	ZS522865	Tapping Screw #2 3x12(BR)		4	9-63	ZS565942	Tapping Screw #2 4x8(Pan)		4
9-13	EJ240535	3-throw AC Outlet	31-1-173	1	9-64	EF562691	Fuse 2.5A 250V	39-1-50	1
9-14	SK652397	Knob 0512-2	34-1-4	1	9-65x	EF249851	Fuse (SEMKO T Type) 5AT (CEE,VDE,BEAB)	39-1-53	2
9-15	ZW651082	Washer (SPC) D3.2x10x1t		1	9-66x	EF601942	Fuse (SEMKO T Type) 630MAT (CEE,VDE,BEAB)	39-1-53	2
9-16	ZS417216	Screw, pan head 3x4		13	9-67x	EF277424	Fuse ST-4 0.8A	39-1-28	2
9-17	EJ223514	3P Fuse Holder (Large) A Lugging Type	40-1-97	1	9-68x	EF459843	Fuse ST-2 5A	39-1-63	1
9-18x	EJ246868	Fuse Holder, AM-6S (CEE, VDE)	40-1-135	1	9-69x	ZW273881	Earth Lug (BEAB)		1
9-19x	ZS325495	Tapping Screw #2 3x6(BR)		36	9-70x	ZW273892	Tothed Lock Washer (BEAB)		1
9-20	EW540123	AC Cord (CUL) 2.5M	26-3-20	1	9-71x	ZS417150	Screw, pan head 4x6 (BEAB)		1
9-21x	EW516600	AC Cord (CEE) YM-0065	26-3-28	1	9-72x	ZW413188	Nut M4, #1 (BEAB)		1
9-22x	EW516475	AC Cord CUL (CSA)	26-3-45	1					
9-23x	EW604585	AC Cord BSI (BEAB)	26-3-37	1					
9-24x	EW604618	AC Cord (EC)(VDE) VM-0064	26-3-34	1					
9-25	EZ631945	Strain Relief SR-4N-4	2-7-49	1					
9-26x	EZ246936	Strain Relief (BEAB) SR-6W-1	2-7-8	1					
ASSEMBLY BLOCK									
9-27	BT240658	Power Trans. AM-2600T-1	38-4-440	1					
9-28x	BT245621	Power Trans. AM-2600T-3 (CEE,BEAB,VDE)	38-4-442	1					
9-29x	BT245586	Power Trans. AM-2600T-2 (CSA,AAL)	38-4-441	1					
9-30	ZW237857	Washer D4.1x10x1t		4					
9-31	ZW273914	Spring Washer		4					
9-32	ZW413188	Nut M4, #1		4					
9-33	EC240603	Elect./C. 10000µF 50WV	24-10-111	2					
9-34	EJ551035	Wrapping Terminal, 4P T5251	32-1-36	1					
9-35	EJ539447	Earth Terminal 2P T4460	32-1-32	2					
9-36x	ZS447761	Tapping Screw #2 3x6 (BR) (Black)		7					
9-37	ES224436	Push SW. JP01	25-5-221	1					
9-38x	ES242346	Push SW. JP17 (CEE,BEAB, VDE)	25-5-224	1					
9-39x	ES239218	Push SW. JP01 (TV-4)(CSA, AAL)	25-5-222	1					
9-40x	EC204671	Ceramic/C. DD31-6 0.01µF(P) 500WV	24-5-66	1					
9-41x	EC286198	Ceramic/C. AL-10 0.01µF(Z) 125WV	24-5-69	1					
9-42	EJ655716	Head Phone Jack 3PMJ1E	31-2-67	1					
9-43	ZW554624	E Jack Nut	7-1-56	1					
9-44	ES240524	Rotary SW. SR321N 1-2-4 30 KC	25-7-47	1					
9-45	EM240592	Level Meter D18B14R	46-1-144	2					
9-46	EL245700	Lamp (Cord Type) 8V 300mA (600mmx2)	28-2-57	1					
9-47	MZ223154	Meter Illumination	T2-5024	1					
9-48	ZS516205	Tapping Screw #2 3x8(BR)w/ washer		2					
9-49	MS241571	Relay Shaft A	M2-5412	2					
9-50	ZW270123	'E' Ring 4M	6-1-9	4					
9-51	ZW322110	Washer (Nylon) D6.1x10.3x 1.0t		2					

10. PHOTO OF FINAL ASSEMBLY BLOCK

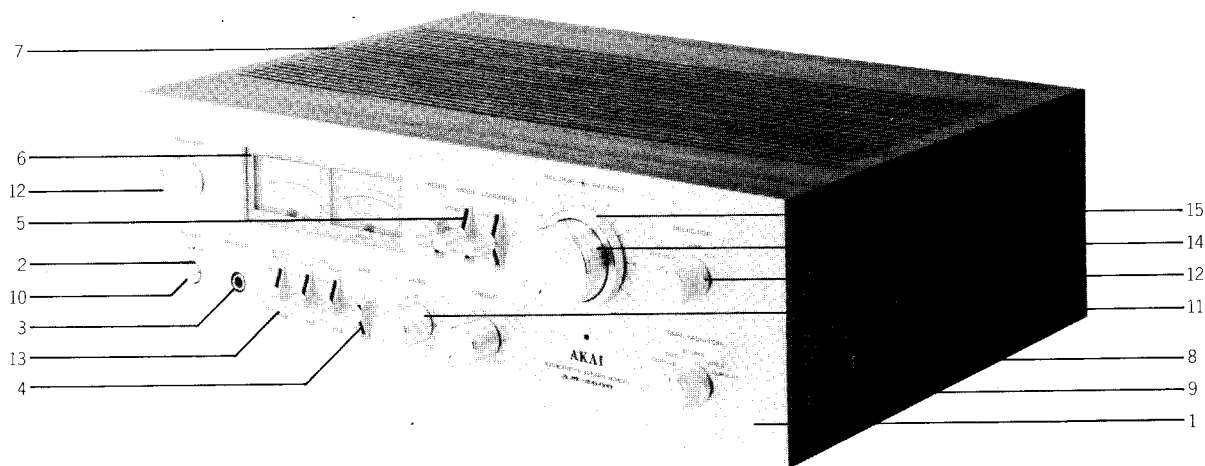

10) FINAL ASSEMBLY BLOCK

Ref. No.	Parts No.	Description	Schematic Q'ty No.
FRONT PANEL BLOCK			
10-1	BD235967	Front Panel Block Comp	1
10-2	MZ224627	Push Button Bush A	M2-5004 1
10-3	ZW526577	Collar B, Jack	MC-5006 1
10-4	SE233807	Lever Escutcheon (Small)	M2-5615 2
10-5	SE244787	Lever Escutcheon (Large)	M2-5616 5
10-6	TA241953	Meter Plate A	M2-5611/
			M2-5622 1
ASSEMBLY BLOCK			
10-7	BC241751	Cabinet	M2-5426 1
10-8	ZW548010	Spot Facing Washer	MU-6028 4
10-9	ZS510344	Screw, binding head 4x12	4
10-10	SK224886	Power Knob AT-2200	M2-5021 1
10-11	SK646817	Single Knob	AA-5250 2
10-12	SK240063	Selector Knob	M2-5428 3
10-13	SK233730	Lever Knob	M2-5614 7
10-14	SK241863	Vol. Knob 2	M2-5612 1
10-15	SK241874	Balance Knob	M2-5613 1

11. LIST OF INTERCHANGEABLE SEMICONDUCTORS

As far as service is concerned, in case the original parts cannot be obtained, the interchangeable parts listed below can be substituted.

Original Parts			Interchangeable Parts	
Description	Parts No.	Utilizing P.C Board	Description	Parts No.
2SA640-1 (E)(F)(G)(H)	ET204221	M2-5432A		
2SA733 (Q)(R)	ET557965	M2-5432A	2SA564 (Q)(R) 2SA628 (D)(E)(F)(G)	ET538154 ET539144
2SA814 (O)(Y)	ET623057	M2-5432A		
2SB556 (O)(R)	ET655650			
2SB560 (E)(F)	ET219868	M2-5432A	2SA661 (O)(Y)	ET650665
2SC536 (E)(F)(G)	ET621235	M2-5432A	2SC711 (E)(F)(G) 2SC945L (K)(P)(Q)(R)	ET520841 ET635218
2SC945L (K)(P)(Q)(R)	ET635218	M2-5432B	2SC536 (E)(F)(G) 2SC711 (E)(F)(G)	ET621235 ET520841
2SC1624 (O)(Y)	ET623046	M2-5432A	2SC1124 (1)(2)	ET551564
2SC1628 (O)(Y)	ET557976	M2-5432A	2SC1520 (K)(L) 2SC1124 (1)(2)	ET655637 ET551564
2SC1312R (G)(H)	ET517263	M2-5618 M2-5617A	2SC1000 (BL)(GR) 2SC1222 (E)(F)	ET622181 ET469810
2SC1940 (K)(L)(M)	ET240636	M2-5632A		
2SD313 (E)(F)	ET452531	M2-5432A	2SD571 (K)(L)	ET666404
2SD426 (O)(R)	ET655648			
2SD571 (K)(L)	ET666404	M2-5432A	2SD438 (E)(F) 2SC1384 (Q)(S)(R)	ET219857 ET623801
1S2472HC	ED245441	M2-5432A	1S2472 1S2472VE	ED214457 ED656278
1S188AM	ED562386	M2-5432A	1N60 1N34A	ED619784 ED219464
GP08D	ED245430	M2-5432A		
RD36E (C)	ED240377	M2-5432A		
GP30G	ED245428	M2-5432A		
SEL105R	ED656357	M2-5617C		

INDEX

Parts No.	Ref. No. & Symbol No.	Parts No.	Ref. No. & Symbol No.	Parts No.	Ref. No. & Symbol No.	Parts No.	Ref. No. & Symbol No.	Parts No.	Ref. No. & Symbol No.
BA235877	6-1	ER245531	2-R47	SK233730	10-13				
BA235980	3-1	ER246363	2-R52, 53	SK240063	10-12				
BA236002	5-1	ER389687	2-R46	SK241863	10-14				
BA236035	2-1	ER622978	2R19, 20	SK241874	10-15				
BA236103	4-1	ES214650	3-SW1	SK646817	10-11				
BA236147	4-2	ES214650	5-SW3	SK652397	9-14				
BA270426	2-2	ES224436	9-37	SP240478	9-10x				
BC241751	10-7	ES239218	9-39x	SP240546	9-8x				
BD235967	10-1	ES240524	9-44	SP241931	9-7				
BT240658	9-27	ES242346	9-38x	SP241942	9-9x				
BT245586	9-29x	ES243674	3-SW2to4	SZ645243	9-62				
BT245621	9-28x	ES243674	5-SW2	TA241953	10-6				
EA241986	8-1	ES245733	6-SW1	TA646773	9-52				
EA245698	7-1	ES246183	5-SW1	ZS325495	9-19x				
EC204671	2-C34to37	ES246194	4-SW1	ZS417148	9-5x				
EC204671	9-40x	ES246227	4-SW2	ZS417150	9-71x				
EC239073	2-C33	ET204221	2-TR1, 2	ZS417216	3-2				
EC240603	9-33	ET219868	2-TR17	ZS417216	5-2				
EC243371	3-C7	ET240636	2-TR10,11	ZS417216	9-16				
EC246767	3-C11,12	ET452531	2-TR18	ZS447761	9-36x				
EC286198	9-41x	ET459810	3-TR1, 2	ZS447840	9-6				
EC538244	2-C2	ET459810	4-TR1, 2	ZS463353	2-3				
EC662128	2-C21	ET520841	2-TR13to15	ZS510344	10-9				
ED214457	2-D2to8	ET557965	2-TR4	ZS516205	9-48				
ED240377	2-D14	ET557965	2-TR12	ZS522865	9-12				
ED245428	2-D16to19	ET623035	2-TR3	ZS565942	9-63				
ED245430	2-D13	ET623046	2-TR6	ZS608185	9-54x				
ED245430	2-D15	ET623057	2-TR7	ZW237857	9-30'				
ED562386	2-D9,10	ET635218	7-TR5	ZW270123	9-50				
ED656357	8-D1	ET655648	9-1	ZW273881	9-69x				
EF249851	9-65x	ET655650	9-2	ZW273892	9-70x				
EF277424	9-67x	ET666404	2-TR16	ZW273914	9-31				
EF459843	9-68x	EV242267	3-VR1, 2	ZW322110	9-51				
EF562691	9-64	EV246148	5-VR1	ZW330412	9-55x				
EF601942	9-66x	EV484863	2-VR1	ZW330423	9-56x				
EJ223514	9-17	EW516475	9-22x	ZW330434	9-57x				
EJ240535	9-13	EW516600	9-21x	ZW330445	9-58x				
EJ240581	9-11	EW540123	9-20	ZW330456	9-59x				
EJ246216	4-J1	EW604585	9-23x	ZW413188	9-32				
EJ246216	6-J1	EW604618	9-24x	ZW413188	9-72x				
EJ246868	9-18x	EZ246936	9-26x	ZW439547	9-60x				
EJ539447	9-35	EZ624734	9-4x	ZW526577	10-3				
EJ551035	9-34	EZ631945	9-25	ZW548010	10-8				
EJ624486	9-3x	MS241571	9-49	ZW554624	9-43				
EJ655716	9-42	MZ223154	9-47	ZW651082	9-15				
EJ698051	6-J2	MZ224627	10-2	ZW698308	9-53				
EL245700	9-46	SD233684	9-61						
EM240592	9-45	SE233807	10-4						
EO650823	2-L1,2	SE244787	10-5						
EP245283	2-RL1	SK224886	10-10						

SECTION 3

SCHEMATIC DIAGRAM

1. AM-2600 SCHEMATIC DIAGRAM 1540652A
2. AM-2600 MAIN AMP SH SCHEMATIC DIAGRAM 1540653A

AM-2600

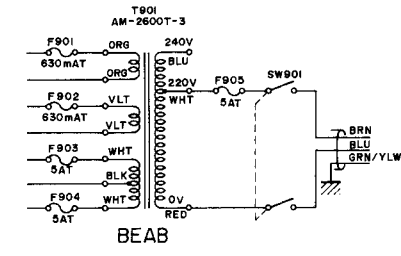
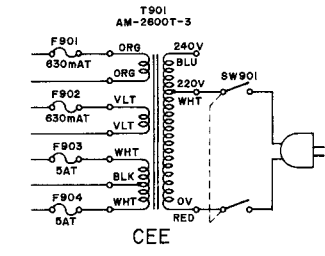
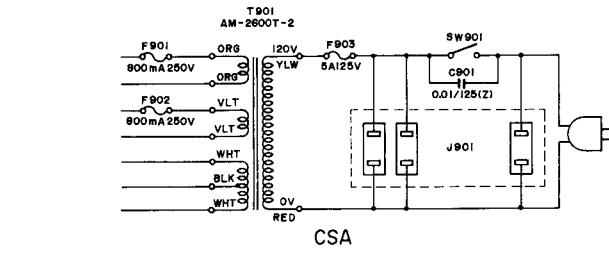
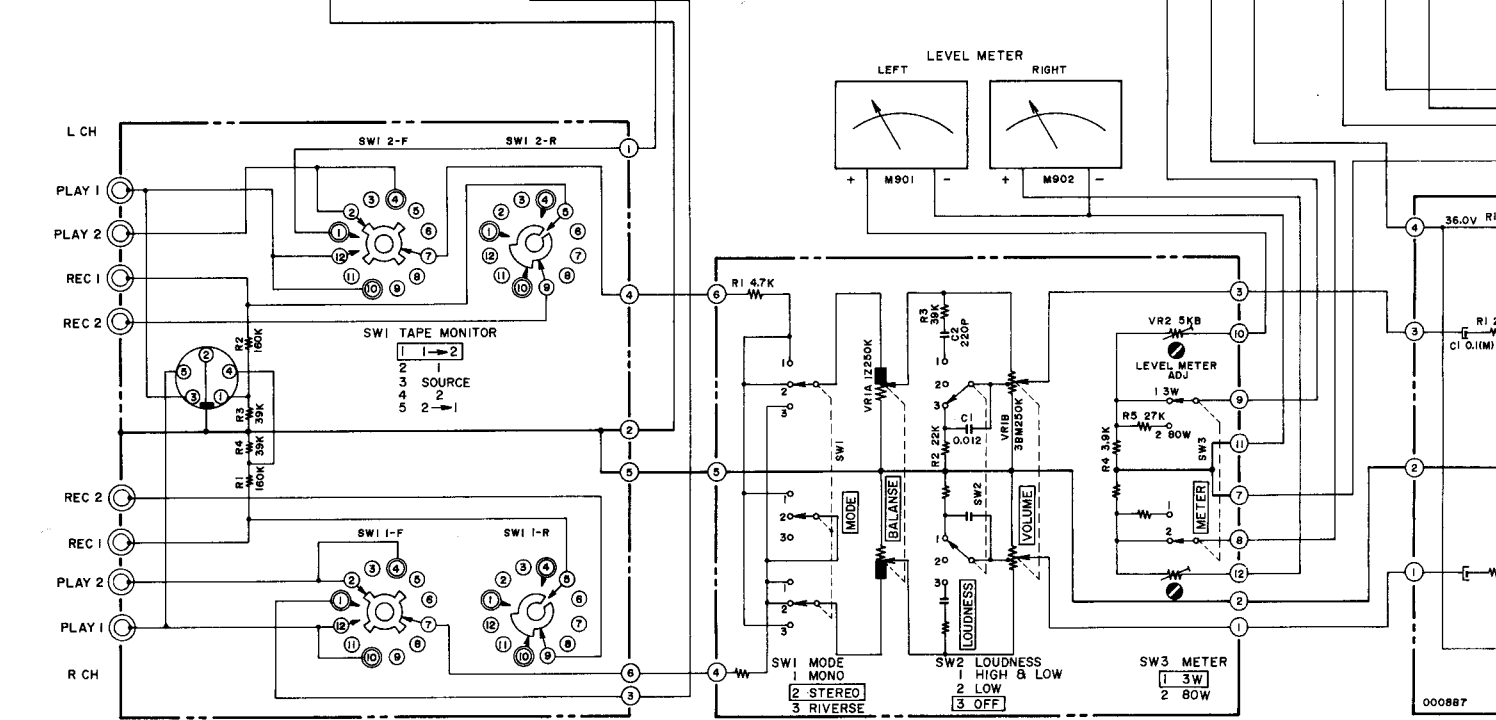
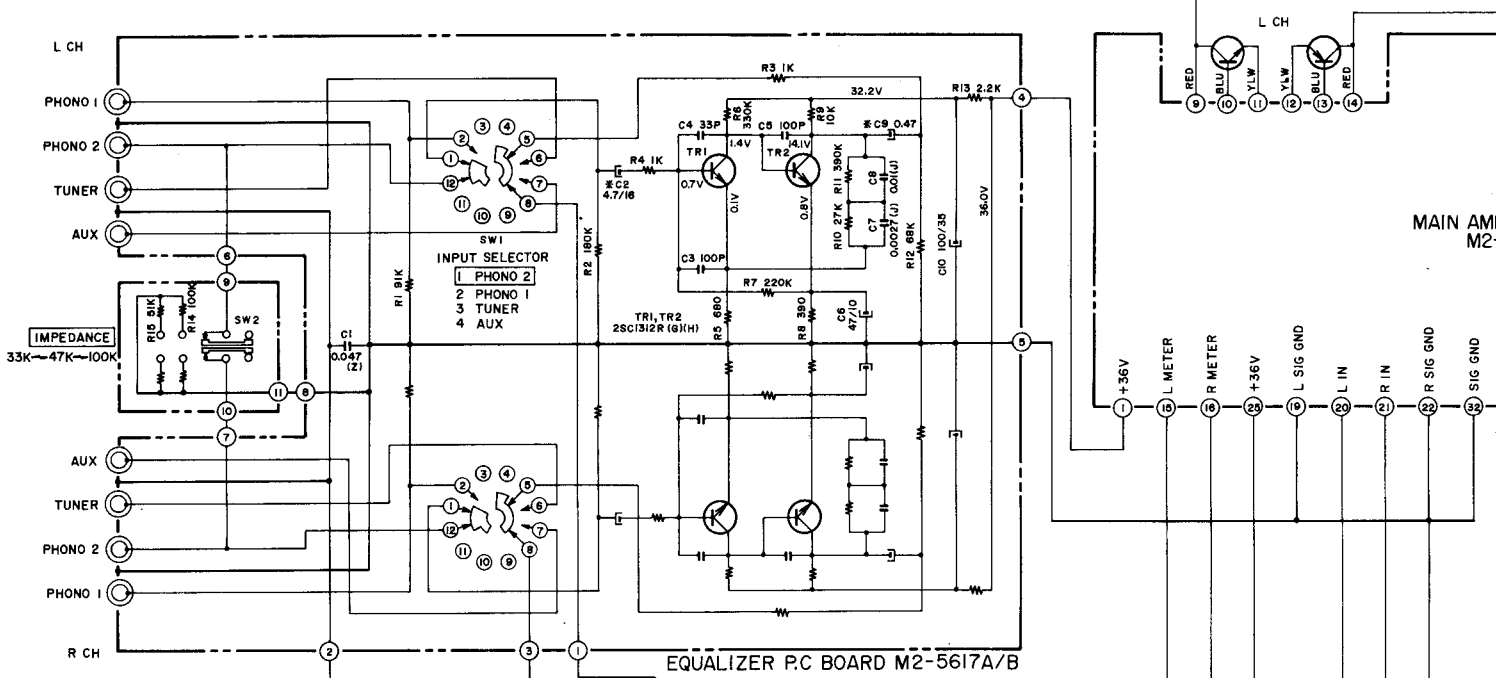

MAIN AMP M2-

000887

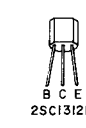

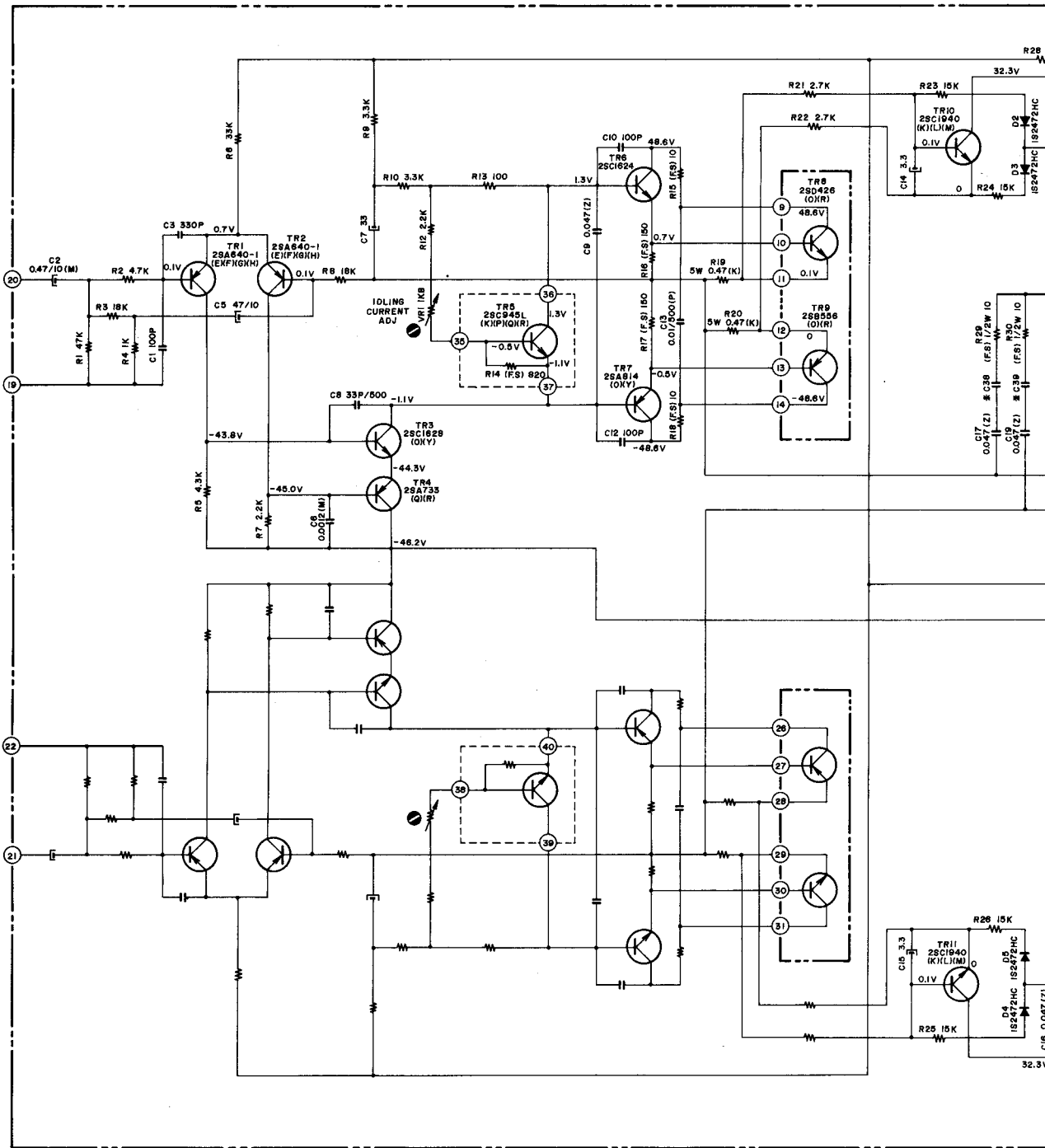

MAIN AMP P.C BOARD M2-5432

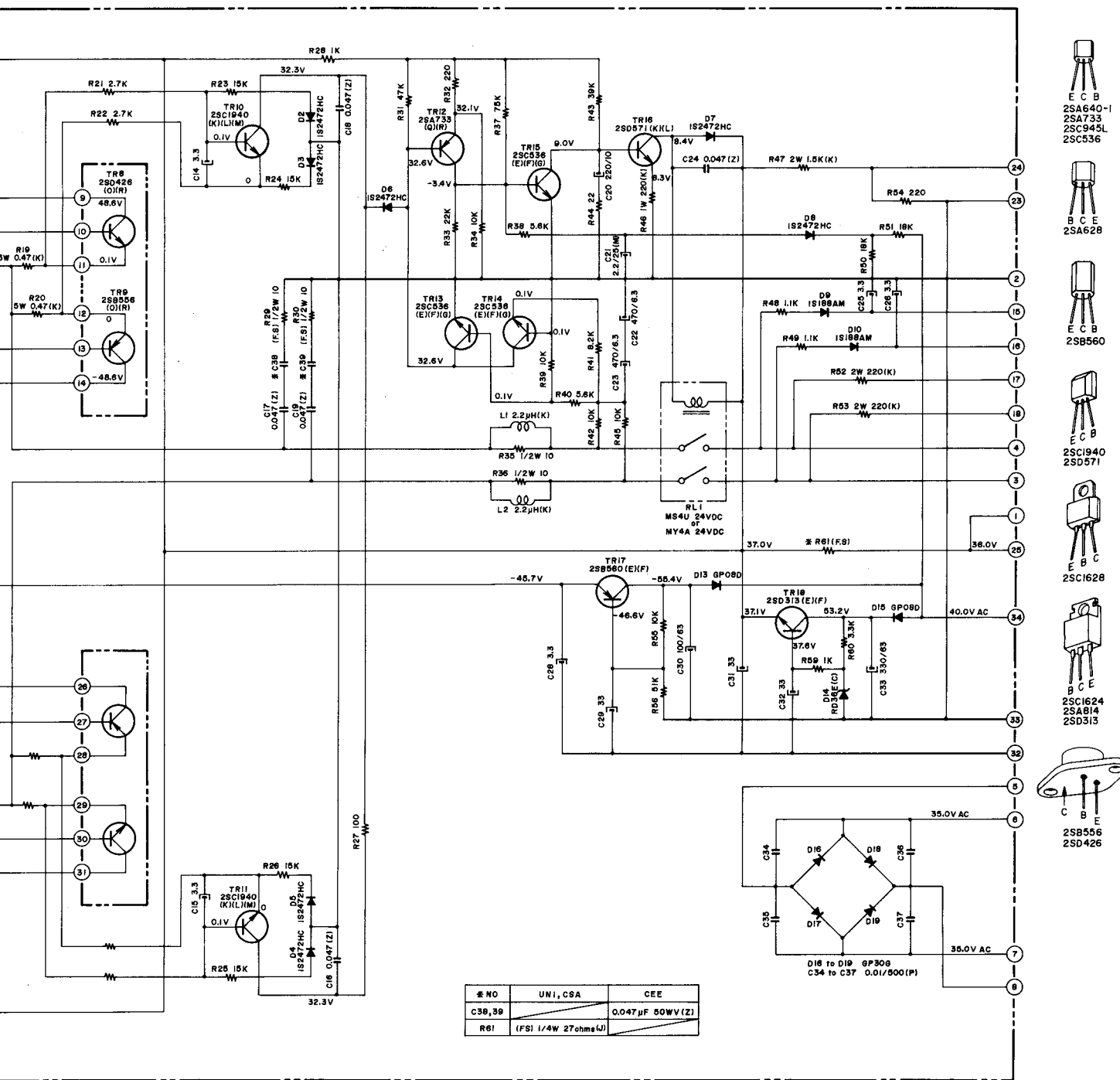

- E C B
2SA640-1
2SA733
2SC945L
2SC536
- B C E
2SA628
- E C B
2SB556
- E C B
2SC1940
2SD571
- E B C
2SC1628
- B C E
2SC1624
2SA814
2SD313
- C B E
2SB556
2SD426

№ NO	UNI, CSA	CEE
C38,39		0.047 µF 50WV(Z)
R81	(FS) 1/4W 27ohms(L)	

NOTE
 UNLESS OTHERWISE SPECIFIED
 ALL RESISTORS IN OHMS (J)
 ALL CAPACITORS IN µF 50WV(K)
 P = µµF
 TRI & TR2 MUST BE USED SAME hFE RANK

**AM-2600 MAIN AMP
 SCHEMATIC DIAGRAM
 NO. 2-2 1540653A**