

Programmable Volume Control

This refers my 'Programmable Volume Control' circuit idea in EFY's November issue. Two mistakes have crept up in the article. First, the last line of the text is wrongly printed as "R11 is about 47 kilohms for the zener diode used." It should be read as "R11 is about 47 ohms for the zener diode used." Second, the pull-down resistors connected to the BCD thumbwheel switch are marked R11, R12, R13 and R14. They should have been marked as R12, R13, R14 and R15 respectively.

BIDYUT CHAKRABORTY
Distt Nadia, W B

Inexpensive Multitester

Kindly refer our circuit idea captioned 'Inexpensive Multitester' published in December issue of EFY.

In the circuit diagram, the switch numbers have been wrongly printed. S2 shall come in place of S1 and vice-versa.

We would like to take this opportunity to add that if anyone faces a difficulty with the use of transistor 2N481 for T3, as specified in the diagram, he may use BC158B in place of 2N481, with identical terminal connections. Only alteration required in the other part of the circuit is the use of 22kilohm resistor for R5 in place of 1k specified in the diagram. This modification shall be useful when someone finds a slight glow in the indicator LED with the test prods unshorted while the unit is powered on and switch S2 is kept at 'test' position.

ARUP KUMAR ROY
AND BHABENDRA NATH PAL
Calcutta

Hourly Chime for Digital Clock

Mr A. Kadarkarai's article in May 1985 issue was interesting but I noticed a few discrepancies.

C10 is shown connected between IC4's pin 6 and ground in circuit diagram, though it is not shown in the components layout for PCB. Similarly C5, included in parts list, is missing from the circuit diagram.

G. SAHA
Gauhati

The author uses two ICs to get 'high to low' or 'low to high' transition alternately, by taking 'a', 'f' and 'e' outputs of hour output of the clock chip. The same decoding of 'f'-segment output can be done using just one IC as given here. Instead of 'a', 'f' and 'e' take 'e', 'd' and 'a' outputs. The IC7400's NAND gates A1 to A3 do the decoding and output a transition every hour as required by the monoshot circuit.

The IC7400 NAND gates are used only for low true output clock chips. For decoding 'high true' output devices use IC7402 and replace each NAND gate with a NOR gate with the same interconnecting wiring. IC7402's pin configurations are given here as they differ from IC7400.

R. MURALI KRISHNAN
Srivilliputtur (TN)

HOURLY CHIME CIRCUIT—(SIMPLIFIED)

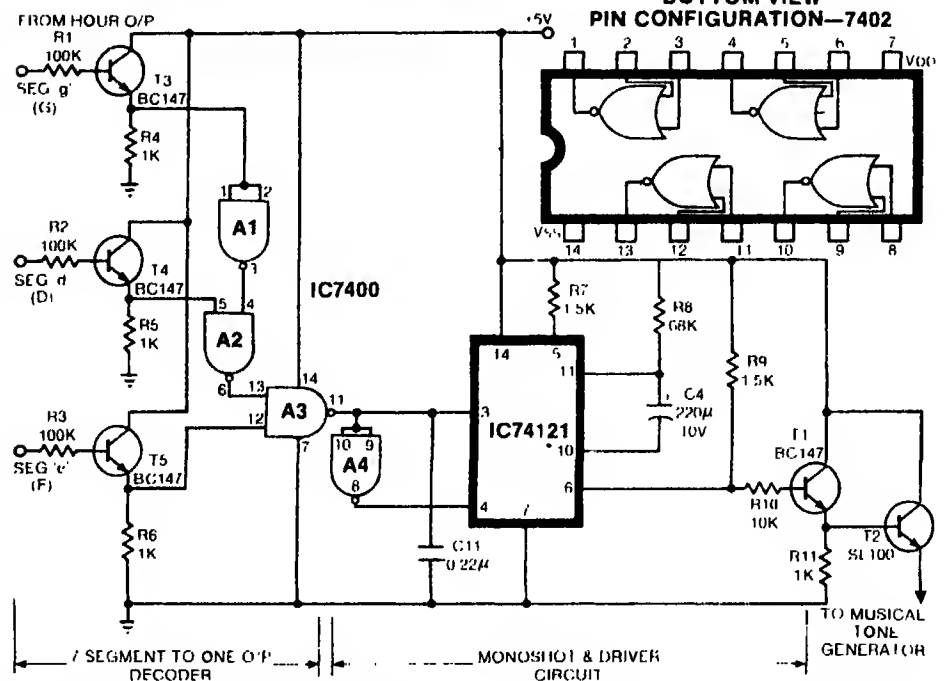

AND gates (A1 and A2) are wrongly shown like NAND gates in the circuit diagram. Further, the decoder circuit can be simplified as shown below.

This reduces the number of gate ICs to just one. With a slight change in the BC147 transistor's connections, they can do the function of inverters also. This way the whole decoding

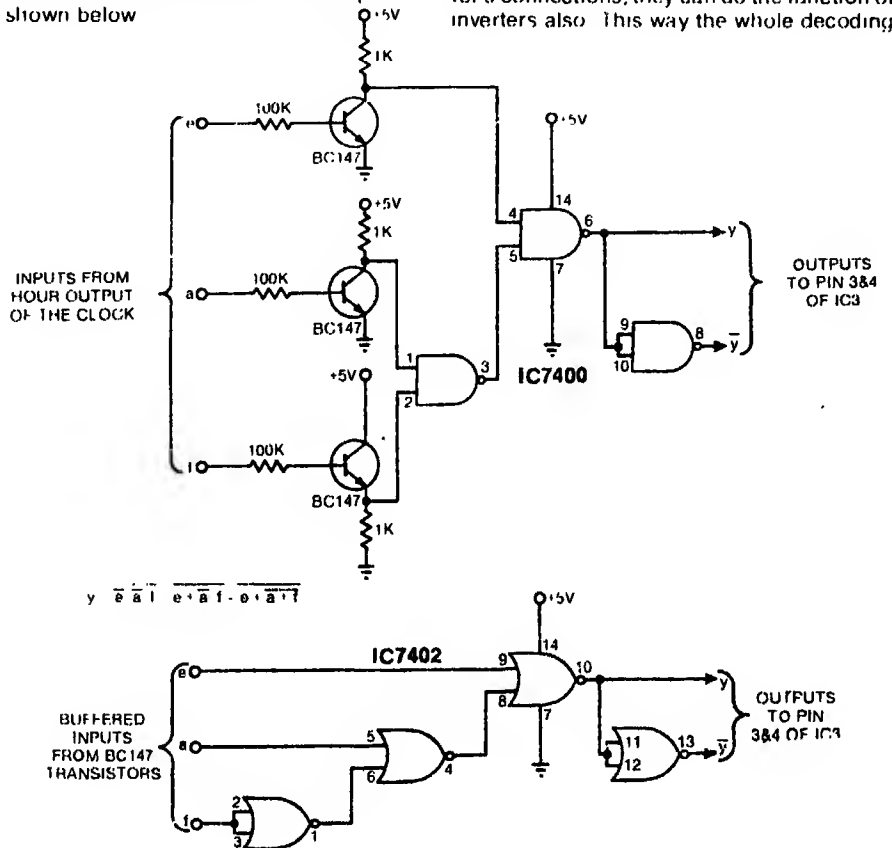

circuit reduces to just three NAND gates which can be obtained from a single 7400 IC.

YOGISH KUMAR K.

Puttur D K

The author, Mr. Kadarkarai, replies:

Capacitor C10 mentioned by Mr Saha may be omitted but $5\mu\text{F}$ capacitor may be replaced by a $6.4\mu\text{F}$. C5 mentioned in the parts list is not required.

The decoder circuit can be simplified as pointed out by Mr Yogish Kumar. But the NOR gate circuit is having some mistake. In the diagram 'a' and 'f' should be interchanged.

Mr Murali Krishnan's idea is very correct and interesting. It will work for both 'active high' as well as 'active low' output clock chips.

New Policy Measures in Electronics

The above article serialised in October, November and December issues of Electronics For You, was based on various policies and procedures concerning electronics industry announced by the government from time to time. These evolved out of a collective work of a number of experts engaged in the field of electronics and colleagues working in the Department of Electronics, Electronics Commission (IPAG) and other ministries. Therefore I claim no credit for the work except compilation of various facts and figures already available through different documents. No personal attribution should be made about statements in the article as they

are a reiteration of the already announced policies.

Dr S L. SARNOT

Additional Director

Electronics Commission (IPAG)

New Delhi

Dimmer Dot[®] Variable Transformers

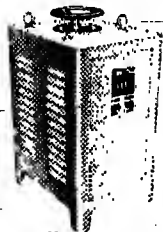

Dimmer Dot is not just another Variable Transformer. Its superior technology of Track & Carbon Brush systems would classify it as **Better of the Best**.

Available in capacities from 2A to 600 Amps, in open or closed, manual or motorised forms.



GREEN DOT ELECTRIC CORPN.

WZ B 2 KIITI NAGAR INDUSTRIAL AREA
NEW DELHI 110 015 PHONE 54117

DOES