

RADIO — ELECTRONICS

formerly

RADIO CRAFT

IN THIS ISSUE
Installing Two-Way
Radio in Taxicabs

HUGO GERNSBACK,
Editor



MICRO-WAVEGUIDES
SEE ELECTRONICS SECTION

DEC
1948

30¢

U. S. and
CANADA

LATEST IN RADIO — ELECTRONICS — TELEVISION

McMurdo
SILVER



Laboratory Caliber Electronic Test Instruments

McMurdo Silver Co., Inc.
1240 MAIN STREET HARTFORD, CONNECTICUT
CABLE ADDRESS: SILVERADIO, U.S.A.

New "VOMAX", new "SPARX" signal tracer, universal test speaker, AM, FM and TV sweep and signal generators, laboratory C/R bridge, multi-frequency standard, wavemeter, universal test speaker, sine/square wave audio oscillator. Buy them from your favorite jobber.

IN OUR NEW CATALOG you will find completely described ten instruments, each of which is in a special class . . . *Laboratory Caliber Electronic Test Instruments* at prices every technician can afford. Each is the product of the exclusive McMurdo Silver LCETI plan . . . the modern plan which makes available to every service technician the same instruments used by the big manufacturers who design and test the very radios you must service.

Instruments of advanced design . . . practical application "know-how" translated into simple *pictorial instruction manuals* . . . backed by over 37 years of world-famous radio engineering leadership . . . have increased LCETI production over

**CATALOG
OF NEW
LCETI**

500% in 3 years and continue its growth.

We are proud that our efforts to bring fine instruments to the service professional and the research engineer have earned such overwhelming acceptance. Without our tens of thousands of customers we could never keep prices down while continuously increasing quality, accuracy and all-around "usability".

We are ever ready to help you turn your shop into a modern, efficiently-equipped service laboratory with Laboratory Caliber Electronic Test Instruments. Our new catalog will show you how easy this is . . . how each of these new instruments can amazingly increase your earning-power and efficiency. Send for 1948-49 LCETI catalog.

**LABORATORY
CALIBER
ELECTRONIC
TEST
INSTRUMENTS**

OVER 37 YEARS OF RADIO ENGINEERING ACHIEVEMENT

McMurdo Silver Co., Inc.

EXECUTIVE OFFICES: 1240 MAIN ST., HARTFORD 3, CONN.
FACTORY OFFICE: 1249 MAIN ST., HARTFORD 3, CONN.

YOU PRACTICE Radio Soldering with Soldering Equipment and Radio Parts I send you. Get practical experience mounting and connecting parts.



YOU BUILD this Tester with parts N. R. I. sends early in course. Soon helps you fix neighbors' Radios and **EARN EXTRA MONEY** in spare time.

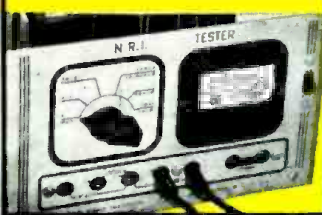

YOU TEST Radio Circuits like this built with parts I send. Build special circuits; learn how to locate and repair circuit defects.



YOU BUILD Vacuum Tube Power Pack; make changes which give you experience with packs of many kinds. Learn how to correct Power Pack troubles.

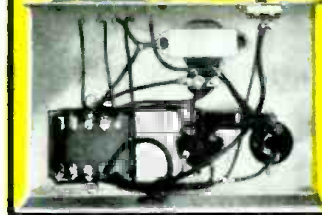

YOU BUILD this A. M. Signal Generator for more valuable experience. It provides amplitude-modulated signals for many tests and experiments.



YOU PRACTICE FM (Frequency Modulation) experiments, get more experience with this Superheterodyne Receiver Circuit you build with parts I send.



You Get **PRACTICAL EXPERIENCE** With This Superheterodyne Receiver

YOU BUILD THIS complete, powerful Radio Receiver that brings in local and distant stations. N. R. I. gives you **ALL** the Radio parts . . . speaker, tubes, chassis, transformer, sockets, loop antenna, etc.

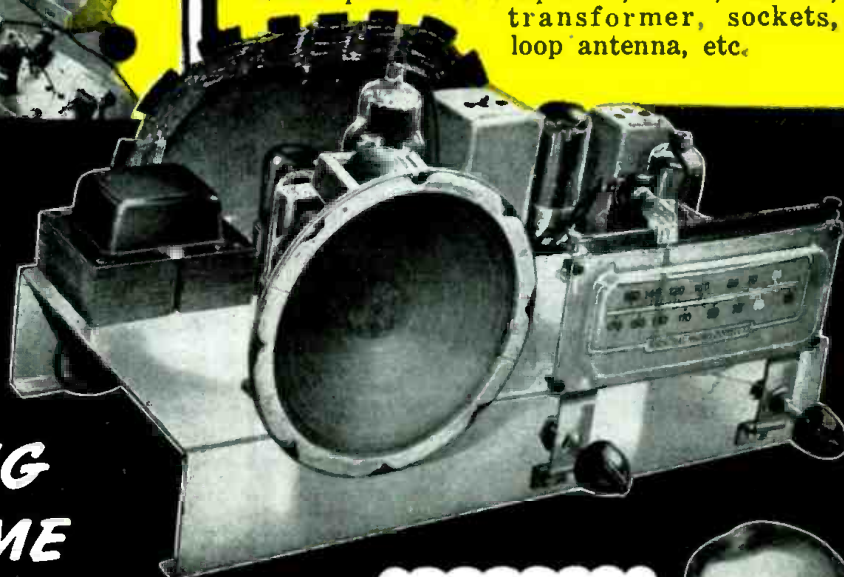

LEARN RADIO

BY PRACTICING IN SPARE TIME

WITH BIG KITS OF PARTS I SEND YOU

Do you want a good-pay job in the fast-growing Radio Industry—or your own Radio Shop? Mail the Coupon for a Sample Lesson and my 64-page book, "How to Be a Success in Radio-Television-Electronics," both **FREE**. See how I will train you at home—how you get practical Radio experience building, testing Radio circuits with **BIG KITS OF PARTS I SEND!**

Many Beginners Soon Make EXTRA Money in Spare Time While Learning

The day you enroll I start sending **EXTRA MONEY** manuals that show how to make **EXTRA** money fixing neighbors' Radios in spare time while still learning! It's probably easier to get started now than ever before because the Radio Repair

Business is booming. Trained Radio Technicians also find profitable opportunities in Police, Aviation, Marine Radio, Broadcasting, Radio Manufacturing, Public Address work. Think of even *greater* opportunities as public demand for Television, FM and Electronic devices continues to grow! Send for **FREE** books now!

Find Out What NRI Can Do For You
Mail Coupon for Sample Lesson and my **FREE** 64-page book. Read the details about my Course, letters from men I trained; see how quickly, easily you can get started. No obligation! Just **MAIL COUPON NOW** in envelope or paste on a penny postal. J. E. SMITH, President, Dept. 8NX, National Radio Institute, Pioneer Home Study Radio School, Washington 9, D. C.

I TRAINED THESE MEN

Has Own Radio Service
"I have my own Radio and Television sales and servicing business. I get enough repair jobs to keep me going right along."—ALEXANDER KISH, 34 Pershing Avenue, Carteret, New Jersey.

Good Spare Time Business
"I have been getting receivers to repair right along, and with N. R. I. methods I don't have to spend much time on them."—S. N. STRICKLAND, 191 Dale Homes, Portsmouth, Virginia.

I WILL TRAIN YOU AT HOME MY COURSE INCLUDES TELEVISION ELECTRONICS



GET BOTH 64 PAGE BOOK SAMPLE LESSON **FREE**

MR. J. E. SMITH, Pres., Dept. 8NX National Radio Institute, Washington 9, D. C.

Mail me **FREE** Sample Lesson and 64-page book about how to win success in Radio and Television—Electronics. (No salesman will call. Please write plainly.)

Name _____ Age _____
Address _____
City _____ Zone _____ State _____
 Check if Veteran

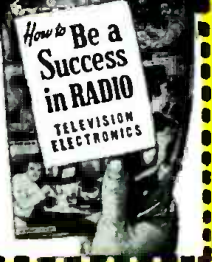

VETERANS

You get this training in your own home under G. I. Bill. Mail Coupon.

APPROVED FOR TRAINING UNDER GI BILL

RADIO — ELECTRONICS

formerly RADIO-CRAFT

Incorporating
SHORT WAVE CRAFT* TELEVISION NEWS*
RADIO & TELEVISION

*Trademark registered U. S. Patent Office

Hugo Gernsback, Editor-in-Chief
Fred Shunaman, Managing Editor
M. Harvey Gernsback, Consulting Editor
Robert F. Scott, W2PWG, Technical Editor
R. H. Dorf, W2QMI, Associate Editor
I. Queen, W2OUX, Editorial Associate
Angie Pascale, Production Manager
Elmer Fuller, Shortwave Editor
Wm. Lyon McLaughlin,
Tech. Illustration Director
G. Aliquo, Circulation Manager
John J. Lamson, Advertising Director
Alfred Stern, Promotion Manager

Contents — December, 1948

Editorial (Page 21)			
Multiperception.....	by Hugo Gernsback	21	
Electronics (Pages 22-29)			
Radar Eyes Bring Safety to Fog-Bound Liverpool.....	by Major Ralph W. Hallows	22	
Micro-Waveguides.....	by Virginia Walters	24	
New A.F. Power Supply.....	by S. R. Winters	27	
Electronics in Medicine, Part IV.....	by Eugene Thompson	28	
FM (Pages 30-32, 84-89)			
FM Telemetering Transmitters.....	by Leon Hillman	30	
FM Station List.....		84	
Television (Page 33-34)			
Gas-Tube Oscillators.....	by Allan Lytel	33	
Servicing (Pages 35-43)			
Radio Set and Service Review (Pilot "Candid TV" Model TV 37).....		35	
Rolling Our Own Output Transformer.....	by J. R. Langham	38	
Columbus Set for Video.....	by David Gnessin	41	
Coin Radios—A Good Business.....	by James McDaniel	42	
Screwdriver, Voltohmmeter and Brains.....	by H. A. Nickerson	43	
Broadcasting and Communications (Pages 44-46)			
Installing Two-Way Radio in Taxicabs.....	by Samuel Freedman	44	
Audio (Pages 47-48)			
Home-Built Phono Uses Two Pickups.....	by Harold J. Gouid	47	
Test Instruments (Pages 50-53)			
Push-Button Generator.....	by Robert E. Altomare	50	
Substitution Unit—Plus.....	by G. N. Carter	52	
Foreign News (Pages 54-56)			
European Report.....	by Major Ralph W. Hallows	54	
New Telephone Recorder.....		56	
Amateur (Pages 58-62)			
More Selectivity for the BC-455-B.....	by E. W. Williamson	58	
Phase-Modulated Exciter.....	by Rufus P. Turner	60	
Construction (Page 64)			
Regulated Power Pack Has Variable Voltage.....	by W. D. Hayes	64	
Radio Science (Pages 72-74)			
Transmission Lines.....	by Robert C. Paine	72	
Departments			
The Radio Month.....	10	Miscellany.....	77
Radio Business.....	14	Radio-Electronic Circuits.....	80
Technotes.....	66	New Patents.....	82
New Devices.....	68	Try This One.....	90
Question Box.....	70	Communications.....	92
People.....	76	Book Reviews.....	97

RADIO-ELECTRONICS, December, 1948, Volume XX, No. 3. Published monthly. Publication Office: Erie Ave., P. O. Box 100, Philadelphia 32, Pa. Entered as second class matter September 27, 1918, at the post office at Philadelphia, Pa., under the Act of March 3, 1879. SUBSCRIPTION RATES: In U. S. and Canada, in U. S. possessions, Mexico, South and Central American countries, \$3.50; \$6.00 for two years; \$8.00 for three years, single copies 7c. All other foreign countries \$4.50 a year, \$8.00 for two years, \$11.00 for three years. Allow one month for change of address. When ordering a change please furnish an address stencil impression from a recent magazine.

RADCRFT PUBLICATIONS, INC. Hugo Gernsback, Pres.; M. Harvey Gernsback, Vice-Pres.; G. Aliquo, Sec'y. Contents Copyright, 1948, by Radcraft Publications, Inc. Text and Illustrations must not be reproduced without permission of copyright owners.

EDITORIAL AND ADVERTISING OFFICES, 25 West Broadway, New York 7, N. Y. Tel. REctor 2-9696. BRANCH ADVERTISING OFFICES: Chicago: 308 W. Washington Street, Telephone RAnciolph 6-7363, Detroit: Frank Holstein, Room 402, Lexington Bldg., 2370 West Grand Blvd., Telephone TRinity 5-7424, Los Angeles: Ralph W. Harker, 606 South Hill St., Tel. TWicker 1-793, San Francisco: Ralph W. Harker, 582 Market St., Tel. GARfield 1-2481.

FOREIGN AGENTS: Great Britain: Atlas Publishing and Distributing Co., Ltd., 18 Bride Lane, Fleet St., London E.C.4, Australia: McGill's Agency, 179 Elizabeth Street, Melbourne, France: Brentano's, 37 Avenue de l'Opera, Paris 2e, Holland: Trilectron, Heemsteedse, Dreef 121 Heemstede, Greece: International Book & News Agency, 17 Amerikis Street, Athens, So. Africa: Central News Agency, Ltd., Cor. Risik & Commissioner Sts., Johannesburg; 112 Long Street, Capetown; 369 Smith Street, Durban, Natal, Universal Book Agency, 79 Harrison Street, Johannesburg, Middle East: Steimatzy Middle East Agency, Jaffa Road, Jerusalem, India: Susil Gupta (Distributors) Co., Armita Bazar Patrika Ltd., 14 Ananda Chatterjee lane, Calcutta.

Editorial and Executive Offices:
25 West Broadway, New York 7, N. Y.



MEMBER AUDIT BUREAU OF CIRCULATION
ABC PAID CIRCULATION 6 MONTHS TO JUNE 30,
1948—112,592. (Publishers Statement) PRINTED
FOR DECEMBER ISSUE—162,000

First again

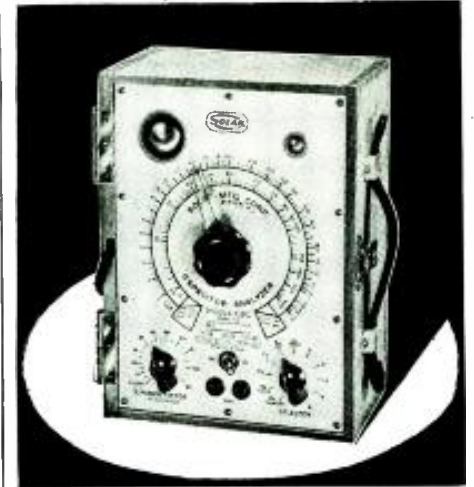

with radio men!

Again this year, radio service men are showing an overwhelming preference for Solar capacitor analyzers—specifically for Model CBC, worthy successor to Solar's famous Model CB, which out-sold all other capacitor analyzers combined.

Model CBC is small in size, light in weight, big in performance and dependability... the ideal low-cost instrument for the service industry:

- Capacitance range... 10 mmf to 800 mf
- Power factor range... 0 to 50 per cent
- Resistance range... 100 to 7,000,000 ohms
- "Quick as a wink" Magic Eye Wien bridge balancing
- Built-in adjustable voltage power supply
- Simplified leakage and Insulation Resistance tests
- Easy to read clear scales

Write today for Bulletin IN-3, which also includes description of Model CF, the Analyzer with the remarkable patented "Quick-check."

SOLAR CAPACITOR SALES CORP.
NORTH BERGEN, NEW JERSEY



SOLAR CAPACITORS

"Quality Above All"

RADIO-ELECTRONICS for



Learn RADIO

TELEVISION, ELECTRONICS by SHOP METHOD HOME TRAINING

Let NATIONAL SCHOOLS, of Los Angeles, a practical Technical Resident Trade School for almost 50 years, train you for today's unlimited opportunities in Radio

You receive all parts, including tubes, for building this fine, modern Superheterodyne Receiver. This and other valuable standard equipment becomes your property.

these two FREE books will tell you how

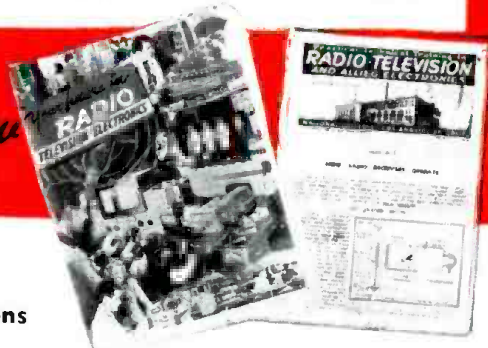

Good Jobs Await the Trained Radio Technician

You are needed in the great, modern Radio, Television and Electronics industry! Trained Radio technicians are in constant and growing demand at excellent pay—in Broadcasting, Communications, Television, Radar, Research Laboratories, Home Radio Service, etc. National Schools Master Shop Method Home Study course, with newly added lessons and equipment, can train you in your spare time, *right in your own home*, for these exciting opportunities. Our method has been proved by the remarkable success of National Schools-trained men all over the world.

You Learn by Building Equipment with Standard Radio Parts We Send You

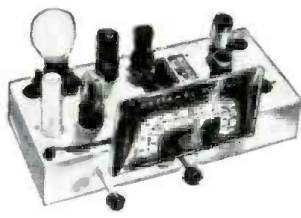

Your National Schools Course includes not only basic theory, but *practical training as well—you learn by doing*. We send you complete standard equipment of professional quality for building various experimental and test units. You advance step by step until you are able to build the modern superheterodyne receiver shown above, which is yours to keep and enjoy. You perform more than 100 experiments—build many types of circuits, signal generator, low power radio transmitter, audio oscillator, and other units. The Free books shown above tell you more about it—send for them today!

Lessons and Instruction Material Are Up-to-date, Practical, Interesting.

National Schools Master Shop Method Home Training gives you basic and advanced instruction in all phases of Radio, Television and Electronics. Each lesson is made easy to understand by numerous illustrations and diagrams. All instruction material has been developed and tested in our own shops and laboratories, under the supervision of our own engineers and instructors. A free sample lesson is yours upon request—use the coupon below.

You Get This and Other Valuable Information in the Free Sample Lesson:

Both Home Study and Resident Training Offered

1. Basic Receiver Circuits and How They are Used.
2. Construction of the Antenna Circuit.
3. How Energy is Picked Up by the Aerial.
4. How Signal Currents are Converted into Sound.
5. How the Tuning Condenser Operates.
6. How the R-F Transformer Handles the Signal, and other data, with diagrams and illustrations.

APPROVED FOR VETERANS
Check Coupon Below

Now! NEW PROFESSIONAL MULTITESTER INCLUDED!



This versatile testing instrument is portable and complete with test leads and batteries. Simple to operate, accurate and dependable. You will be able to quickly locate trouble and adjust the most delicate circuits. You can use the Multitester at home or on service calls. It is designed to measure AC and DC volts, current, resistance and decibels. You will be proud to own and use this valuable professional instrument.

NATIONAL SCHOOLS LOS ANGELES 37, CALIFORNIA EST. 1905 MAIL OPPORTUNITY COUPON FOR QUICK ACTION

National Schools, Dept. RC-12
4000 S. Figueroa, Los Angeles 37, Calif. Paste on a postcard

Mail me FREE the books mentioned in your ad including a sample lesson of your course. I understand no salesman will call on me.

NAME AGE.....

ADDRESS

CITY ZONE..... STATE.....

Check here if Veteran of World War II

GET THE DETAILS—SEND THE COUPON →

Capitol Radio Engineering Institute—Pioneer in Radio Engineering Instruction Since 1927

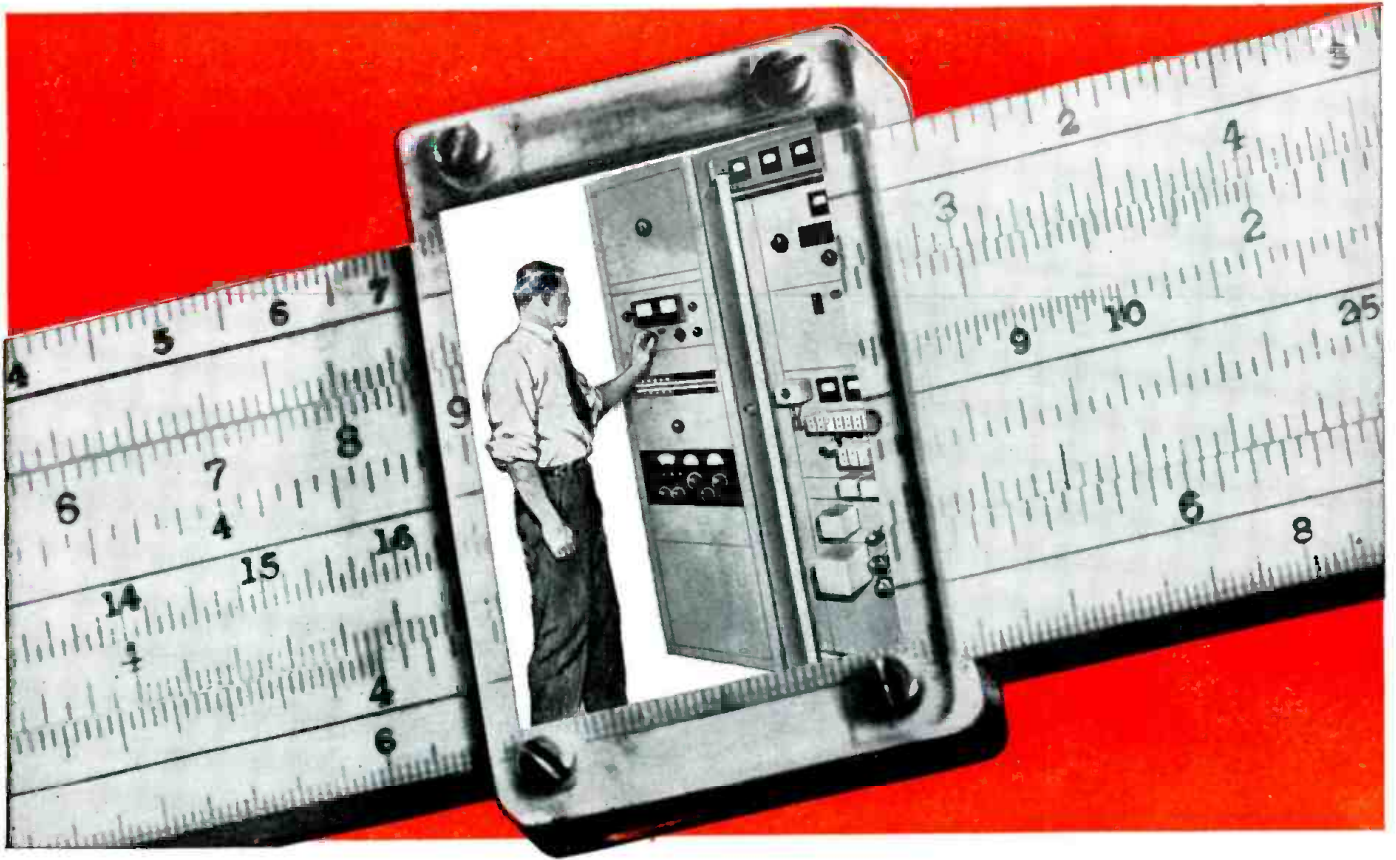

Here's how you can figure on a **BETTER JOB** in RADIO-ELECTRONICS, Broadcasting, Television, Servicing, Manufacturing

Add CREI Technical Training to Your Present Radio Experience, Then Get That Better Radio Job—Make More Money—Enjoy Increased Security.

You can't plan your future on a slide rule. But you can take a measurement of your own capabilities.

Look at the successful radioman. You'll find that he's the fellow who looked and *planned* ahead. Today, you have the same opportunity—at a time when radio's *technical* progress has gone beyond the supply of technical Manpower. Never before have so many men like you had the opportunity to step ahead into better-paying jobs . . . jobs that offer real interest and security in any one of the many expanding fields that urgently need competently trained men.

You can't say, "I don't need more training." Every ambitious radio technician needs more training. No matter what your experi-

If you have had professional or amateur radio experience and want to make more money, let us prove to you we have the training you need to qualify for a better radio job. To help us answer intelligently your inquiry—please state briefly your background of experience, education and present position.

Capitol Radio Engineering Institute

An Accredited Technical Institute

Dept. RE-12, 16th and Park Road, N. W., Washington 10, D. C.
Branch Offices: New York (7) 170 Broadway • San Francisco (2) 760 Market St.



ence, you must fortify yourself with up-to-date technical knowledge to qualify for the better jobs and to stave off the new competition that war-time activity has brought into the field.

CREI has a course of training for *you*. You will find our proved type of training practical and thorough. Whether your future lies in broadcasting, television, servicing, manufacturing or any branch of communications, you will find that you can "go all the way with CREI" from introductory, basic principles to advanced training, and on to specialized fields of radio-electronics.

Send for, and read, our new catalog and course outline. It explains our self-improvement program, courses and what CREI can do for you. It will give you a good idea how practical and easy-to-understand our training is, and why many thousands have enrolled for CREI courses since 1927.

VETERANS! CREI TRAINING AVAILABLE UNDER G. I. BILL

MAIL COUPON FOR FREE BOOKLET

CAPITOL RADIO ENGINEERING INSTITUTE
16th & Park Road, N. W., Dept. RE-12, Washington 10, D. C.

Gentlemen: Please send your free booklet, "CREI training for your better job in Radio-Electronics," together with full details of your home-study training. I am attaching a brief resume of my experience, education and present position.

Check field of greatest interest:

- PRACTICAL RADIO-ELECTRONICS PRACTICAL TELEVISION
 BROADCASTING AERONAUTICAL RADIO ENGINEERING
 RECEIVER SERVICING

NAME _____

STREET _____

CITY _____ ZONE _____ STATE _____

I AM ENTITLED TO TRAINING UNDER G. I. BILL.

RADIO-ELECTRONICS for

I Put You to Work with Your Hands to LEARN RADIO!
You Build Receivers! You Make Typical Defects Occur
and Make Tests to Prove the Theory!



F. L. SPRAYBERRY, PRES-
IDENT of the SPRAYBERRY
ACADEMY OF RADIO. This
is the man who directs
your study. His years of
experience and Radio
"know-how" assure you of
the finest in home Radio
Training!

YOU GET
8 BIG KITS OF RADIO
PARTS & EQUIPMENT
including
2-BAND SUPER
RECEIVER!
and 16 RANGE METER
FOR TESTING

LEARN RADIO
to MAKE MONEY!

LOW COST TRAINING — EASY PAYMENT PLAN!

You Learn at Home How to
Build and Test Dozens and
Dozens of Circuits — Simple
and Complex!

YOU DO
OVER 175
INSTRUCTIVE
EXPERIMENTS

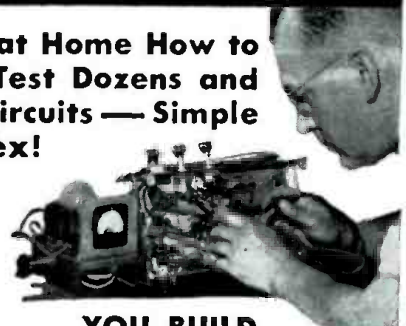

YOU BUILD
ALL THESE TESTERS

..... AND MORE!



I give you a fine,
moving-coil type
Meter Instrument
on Jewel Bearings
— with parts for a
complete Analyzer
Circuit Continuity
Tester. You learn
how to check and
correct Receiver

defects with professional speed and
accuracy.

You'll get
valuable expe-
rience and
practice
building this
Signal Gener-
ator and
multi-
purpose
Tester.

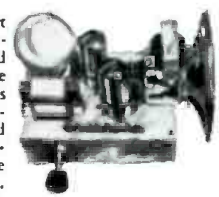

Makes a
breeze out of fixing Radios and you
don't have to spend money on ready-
made Equipment.

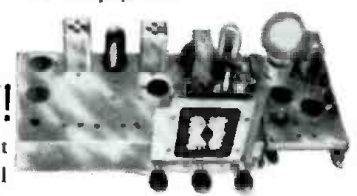

Soldering, wiring, connecting Radio
parts . . . building circuits with your
own hands — you can't beat this
method of learning. When you con-
struct this Rectifier and Filter,
Resistor and Condenser Tester, etc., you
get a really practical slant on Radio
that leads to a money-making future.

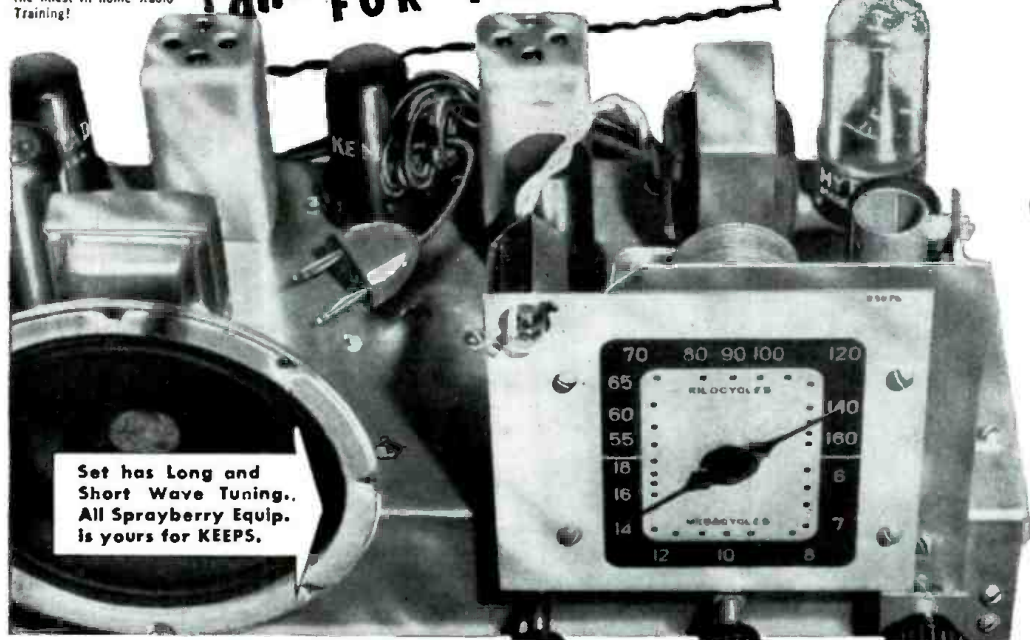

Set has Long and
Short Wave Tuning.
All Sprayberry Equip.
is yours for **KEEPS**.

SPRAYBERRY HOME TRAINING is PLANNED to MAKE MONEY for you FAST!

I train you with regular professional Radio Equip-
ment. I tell you exactly what to do . . . how to do
it. You handle Radio Parts, see them operate,
learn what they're for. With the fine Kits I supply,
you learn how to build Radio Circuits, construct
your own Test Equipment. I'll show you how to
cause typical Radio defects so you can watch and
see how they act. You learn the latest methods for
trouble-shooting and repair. All this adds up to

the finest kind of "bench" experience. And you get
it right in your own home. In no time at all, you'll
be ready for a business of your own or a good job
in Radio, FM, Television,
Radar, Industrial Elec-
tronics, etc. Now's
the time to get
started!

VETERANS!
Approved for
G. I. Training
Under Public
Laws 16 and
346

SEND FOR MY
VALUABLE
FREE BOOKS!

NOW! TWO LOCATIONS
To Serve You Better!
Mail Coupon to Location
Nearest Your Home



SPRAYBERRY ACADEMY of RADIO, Dept. 20-M
SPRAYBERRY BUILDING, PUEBLO, COLORADO, Or
20 NORTH WACKER DRIVE, CHICAGO 6, ILLINOIS
Please rush my **FREE** copies of "How to Make Money in Radio, Electronics
and Television" and "How to Read Radio Diagrams and Symbols."

NAME _____ AGE _____
ADDRESS _____
CITY _____ STATE _____

(Mail in envelope or paste on penny postcard)

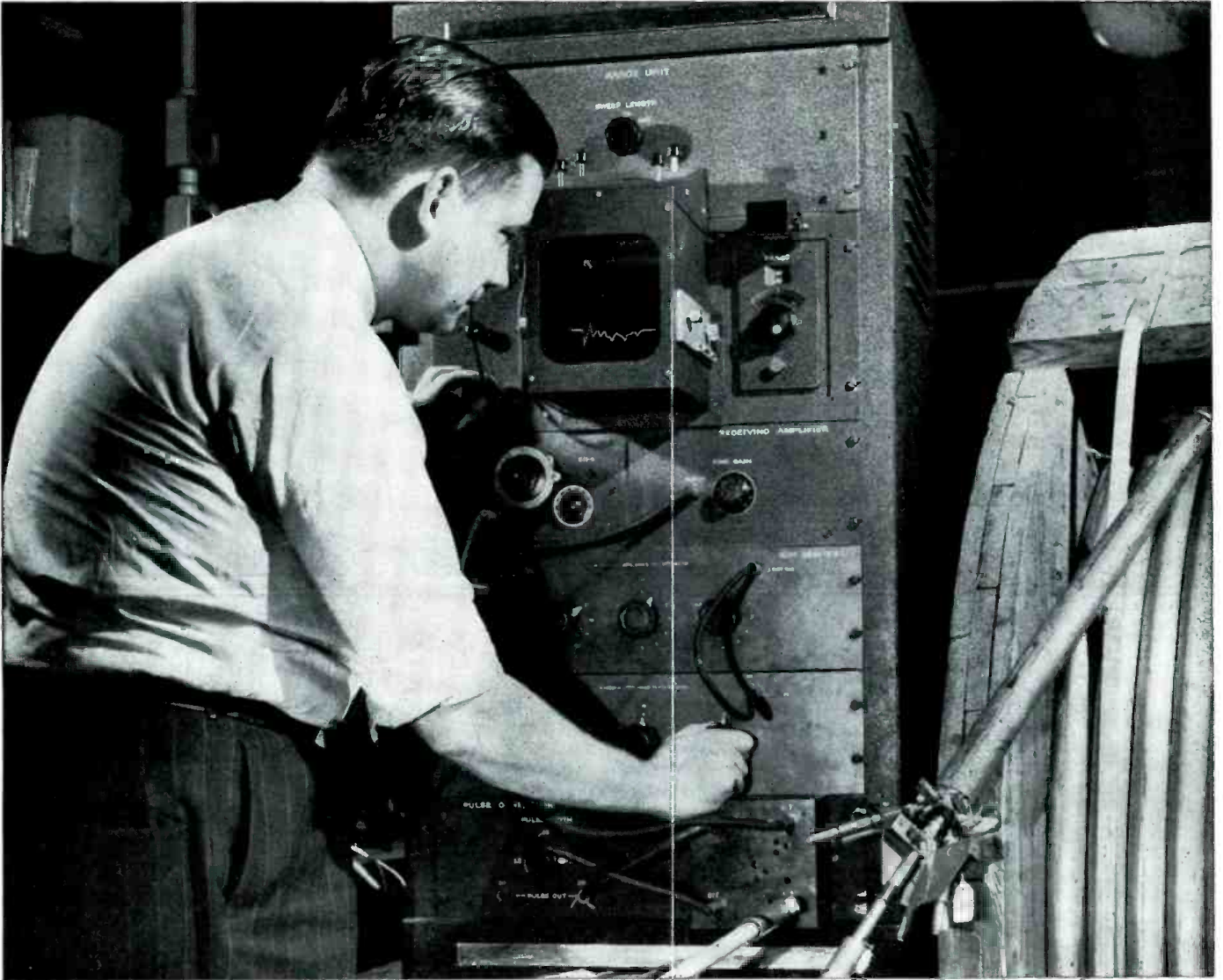

He asks an echo

Radar sends out pulses of electric waves which, reflected from a target, return to reveal the target's location.

Likewise, the apparatus pictured above sends electric waves over a coaxial telephone cable. Minute irregularities reflect the waves back to their origin; the echo makes a trace on an oscilloscope screen and so tells where to look for the trouble.

Telephone messages need smooth "highways" over which to travel across country: circuits able to transmit every talking fre-

quency, without distortion. Television needs even smoother highways and at many more frequencies. So Bell Laboratories devised this method of spot-testing the cable over the entire frequency band needed for telephone or television. It is so delicate that any possible interference with transmission is detected at once. Its use makes sure that every inch of highway is clear.

This is another important example of how Bell Telephone Laboratories constantly develop finer communications for the nation.

BELL TELEPHONE LABORATORIES

Exploring and inventing, devising and perfecting for continued improvements and economies in telephone service.



RADIO-ELECTRONICS for

Our GREATEST OFFER in 17 YEARS

Amazing New **EQUIPMENT** Helps

Prepare You **FASTER, EASIER** for . . .

TELEVISION Radio... Electronics

Here's good news . . . big news . . . our **BIGGEST NEWS** in 17 years. The equipment pictured at left gives a partial idea of D.T.I.'s remarkable, new combination of shop-method training aids . . . to prepare you **AT HOME** for your start in Television-Radio-Electronics.

Get 48-Page Book FREE

Mail coupon today for D.T.I.'s big new 48-page **OPPORTUNITY GUIDE BOOK**. See how this amazing newer method helps you get started toward a **GOOD JOB** or your **OWN BUSINESS** in one of America's most promising, thrilling fields . . . that includes Television . . . F.M., Train, 2-Way Taxi, Aviation, and Broadcast Radio . . . Industrial Electronics . . . and other fast-developing branches.

In addition to well-illustrated lessons, you work over 300 instructive experiments from 16 shipments of Radio-Electronic parts. Among these projects you build and keep a commercial-type **CATHODE RAY OSCILLOSCOPE** . . . that helps you get practical Television circuit training. You also build and keep a double-range **R-F SIGNAL GENERATOR**, a jewel-bearing **MULTI-METER** and a quality 6-tube **SUPERHET RADIO**.

YOU **BUILD** AND **KEEP** ALL OF THE EQUIPMENT AT LEFT . . . MAKE OVER **300** HOME EXPERIMENTS!

MODERN CHICAGO LABORATORIES

If you prefer, you can get **ALL** your preparation in our new, Chicago training laboratories . . . one of the finest of its kind. Ample instructors . . . modern equipment . . . Write for details!

You also use **HOME MOVIES** . . . a **D.T.I. Exclusive!**

D.T.I. alone includes the modern, visual training aid . . . **MOVIES** . . . to help you learn faster, easier at home. You see electrons on the march and other fascinating "hidden action" — a remarkable home training advantage that speeds your progress.

You Get D.T.I.'s Effective **EMPLOYMENT SERVICE**

When you complete your training, our effective Employment Service is available to you without extra cost, to help you get started.

MAIL TODAY!



OSCILLOSCOPE

MULTI-METER

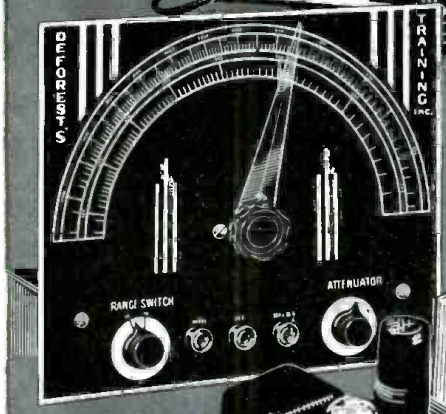

R-F SIGNAL GENERATOR

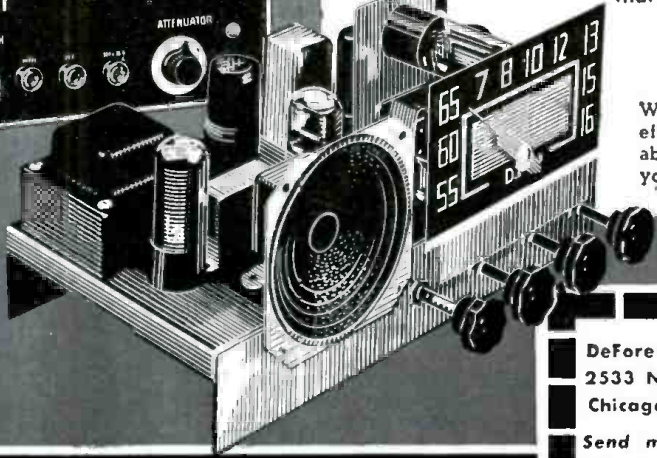

6-TUBE RADIO RECEIVER



DeFOREST'S TRAINING, INC.
CHICAGO, ILLINOIS
Affiliated with the De Vry Corporation
Builders of Electronic and Movie Equipment

DeForest's Training, Inc.
2533 N. Ashland Ave., Dept. RC-E12
Chicago 14, Illinois

Send me **FREE** your 48-page **OPPORTUNITY GUIDE BOOK** showing how I may make my start in Television • Radio • Electronics.

Name _____ Age _____
Street _____ Apt. _____
City _____ Zone _____ State _____

THE MOST DESIRABLE ANTENNA MOUNT EVER MADE!

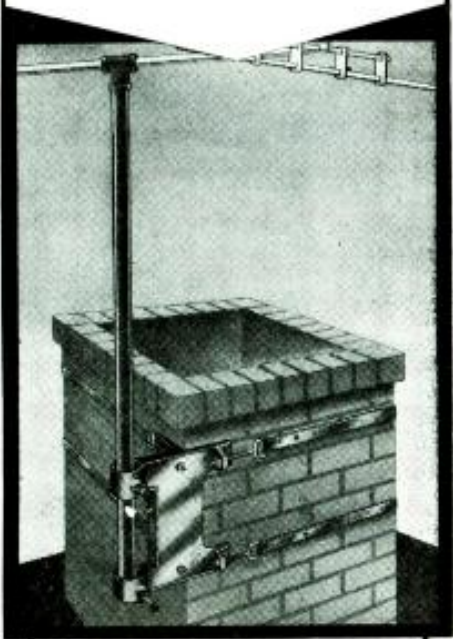

Pat. Pending

Chimney Mount Antenna Base

- for TELEVISION
- FM ● AMATEURS

List Price: **\$7.50**

Cost to Retailer: \$4.50

Installed in 10 minutes • Permits Use
of Several Mounts on One Chimney

Chimney Mount is by far the fastest selling product of its type in the radio and television fields. It can be installed in ten minutes without the use of special tools or drilling of holes. Several mounts can be strapped to one chimney—to pole, 2 x 4, side of house or to any rectangular roof extension. Fastens aerial to highest point with galvanized steel bands having a combined tensile strength of more than 3,000 lbs. Made of corrosion-resistant aircraft-type aluminum alloy. Weight: 3 lbs.

Available Through All Leading
Jobbers and Dealers or Write to:

South River Metal Products Co.

South River, New Jersey

TOWN MEETING of Radio Servicemen held its second session in New York City September 27, 28 and 29. About 1,500 technicians registered for one or more of the sessions—roughly the same number as attended the first session at Philadelphia last January.

Highlight of the first evening was a paper "Antenna Installation" by Ira Kamen. RMA's president Max Balcom was also well received when he stressed the importance of television to the servicing technician, as was a symposium "TV Installation in the Home." Less well received was a paper "How to Collect Your Bills," presumably because the bulk of the radiomen present were operating on a cash basis.

Other papers which attracted special attention were "Case History of a Successful TV Service Shop," by Harold Suss, "Television Service in the Shop," by Carl Quirk, and John F. Rider's talk on sweep generators. Listeners said the latter's only fault was that he had only 40 minutes in which to talk.

On the business side, Austin Lescarboura's "Advertising and Public Relations" was considered the best paper. Others were given a lower rating by the assembled servicemen chiefly because they seemed aimed at the larger shops, whereas the majority of the attending technicians came from one- and two-man establishments.

Next Town Meeting was scheduled for Boston, November 15, 16 and 17.

RADIO TECHNICIANS of Massachusetts and New York discussed the question of wider organization of servicemen, at a meeting held in Rochester, N. Y., October 10, 1948. The meeting was called by the Radio Technicians Guild of Rochester to discuss national organization. Delegates from Boston, Springfield, New Bedford, Binghamton, Rochester, Watertown, New York City, and several other points attended.

Failing to agree on whether formation of a national organization or a state federation was the best immediate step, the group proceeded to form both organizations. The State Federa-

tion was set up with Lawrence Raymo of Rochester as president, Wayne Shaw of Binghamton as secretary, and Max Liebowitz of New York as organizer. The first meeting of the new organization was set for Binghamton on the 31st of October, with delegates and visitors from all interested radio servicemen's organizations invited. Steps were also taken to incorporate a national organization based on the Radio Technicians Guild of northern New York and Massachusetts, and a temporary board of directors was named.

Officers of the new board are Frank Keefe, Indian Orchard, Mass., president; Ray Mattraw, Watertown, N. Y.; vice-president; Lewis L. Sharrard, Springfield, Mass., secretary, Bertram L. Lewis, Rochester, N. Y., executive secretary, and Herbert Gamer, Roxbury, Mass., treasurer.

EUROPEAN BROADCASTERS are affected by the signing of a new treaty at Copenhagen in September. To add more channels to the European long- and medium-wave broadcast bands, channel width was narrowed down to 8 or 9 kc depending on the assigned frequency. In the reallocation of frequencies the U. S. was given three channels in Occupied Germany instead of the former 13. The treaty takes effect in March, 1950.

TV IN BARS and other public places can legally be stopped by station owners if they wish, said David M. Solinger, New York attorney, in the *Columbia Law Review* last month. The article, entitled "Unauthorized Uses of Television Broadcasting," points out that television is protected by copyright laws, as well as by other common-law property rights.

"An owner of a television receiver," wrote Mr. Solinger, "by performing a program in a tavern, hotel, restaurant, private auditorium, or motion-picture theatre, has thereby infringed on the copyright of the creator to the same degree as he would have had he reproduced the material on his own stage with his own live cast."



Five presidents of local radio organizations were in attendance at the Rochester meeting. From left to right are: Al Saunders, Boston, Mass.; Wayne Shaw, Binghamton, N. Y.; T. Lawrence Raymo, Rochester, N. Y.; Max Liebowitz, New York, N. Y.; Ben De Young, Ithaca, N. Y.

FM-EQUIPPED CAR is being used by E. A. Merryman, chief engineer of WBUZ-FM, Bradbury Heights, Md., to check on reports of bad reception. The receiver installed in the car was made from a Pilotuner and an old AM auto radio. The antenna is a dipole. The car, Merryman says, has enabled him to assist many listeners.

RAILROAD TELEVISION was demonstrated successfully aboard a Baltimore & Ohio train travelling from Washington to Jersey City, N. J. A receiver installed in one of the cars picked up nearly all of the second game of the World Series.

In the Washington railroad station the broadcast was received from WNBW, WTTG, and WMAL-TV, Washington. About half-way between Washington and Baltimore, the receiver was switched to a Baltimore station, and as the train neared Jersey City, Philadelphia and New York stations were utilized.

The antenna mounted atop the railroad car picked up interference-free signals over most of the route except when the train passed under tunnels and through yards with large numbers of electrical signal devices.

William M. Snyder, assistant general passenger agent of the railroad, said that the reception was about as good as in the average home. If tests continue to be successful, he added, the railroad may make permanent video installations on its crack trains.

TV TUBE SHORTAGE will last until late 1949 or 1950, predicted Hamilton Hoge, president of U.S. Television, last month. Although 1.6 million cathode-ray tubes will be made next year, there will not be nearly enough to satisfy the demand. The tube shortage is the only important one hampering television.

Mr. Hoge pointed out that not all of the tube output would go into new receivers. With the increasing military use of TV, the shortage may be aggravated by heavy government demands. Replacements for existing receivers will also reduce the number of tubes available for new sets.

Basic cause of the shortage is the time required for tube makers to tool up. Plans announced this summer, for example, will not be in effect until late 1949 or early 1950.

U.S. VIDEO STANDARDS would be established in foreign countries if plans disclosed last month by the RMA were successful. Members of the RMA, apparently concerned over British efforts to spread their standards in other countries, pointed out that receivers must be made to conform to transmission standards. Sale of American receivers abroad would thus depend largely on the standards used in Europe. Since no American sets are presently available for export, the plans are long-range, anticipating a time when the American market will have been satisfied.

MINE DETECTORS may soon be used by veterinarians, at least in principle. A new device for the detection of metal is designed to locate foreign objects in animals. A bit of baling wire swallowed by a cow or a bullet fired into a farm animal or pet by a trigger-happy hunter may be located by passing the detector over the animal's body. Developed by the Army Medical Department, the device is awaiting final clinical tests.

TELEVISION GRANTS were halted by the FCC last month for a six-month period. During this time no action will be taken on applications for TV station licenses. In announcing the freeze, Wayne Coy, FCC chairman, said that evidence presented at an industry-commission conference held in Washington on September 13 and 14 raised serious questions about the present and proposed frequency-allocation scheme. An engineering conference will be called to discuss the question; meantime, no further allocations will be made.

Operation of the 37 stations now on the air and construction permits previously authorized will remain unaffected. Mr. Coy emphasized that the usefulness of presently owned and marketed television receivers will not be impaired.

BRAZILIAN TELEVISION plans were completed last month and South America's first television station will be in operation within a year, according to an announcement made by Cesar Ladeira, one of the founders of the newly organized Radio Televisão do Brazil. The station will be at Rio de Janeiro.

A 28-30-hour weekly schedule of programs will be carried, including live shows, news films, educational programs, and sports.

The 5,000-watt transmitter and all other studio and transmitter equipment will be furnished by General Electric.

FINE OF \$10,000 or two years' imprisonment may be the price of operating a phonograph oscillator so as to cause interference to radio reception, readers of the *New York Daily News* were informed last month. The paper had reported a suggestion from a reader that neighbors' sets whose volume controls were turned up too high might be jammed with a phono oscillator.

In a letter to the newspaper the FCC warned of the Communications Act, which states that any radio transmission—no matter how low the power—which interferes with the reception of other stations is illegal and punishable.

THE QUARTER CENTURY Wireless Association will hold a dinner meeting in New York's Fraunces Tavern on December 3rd, John DiBlasi, W2FX, the association's president, announced last month. The association, membership in which is open to those who have been active hams for at least 25 years, now has more than 100 members. Among the recent joiners is FCC Commissioner George E. Sterling, W3DF.

IRC Power Wire Wounds are better built every step of the way



Starting right from the winding form IRC Power Wire Wounds combine the best of materials, workmanship and resistor "know-how".

Highest grade alloy wire uniformly wound on sturdy ceramic tubes. Terminals spot welded for security; heavily tin dipped for easy soldering.



Climate-proof cement coating provides dark, rough surface—best for rapid heat dissipation, moisture protection and ability to withstand reasonable overloads.

Resistors cured at LOW temperature prevents damage to resistance windings, and loss of temper in terminals. Bands for adjustable types feature stainless steel springs and silver contacts. Cannot corrode to cause high resistance.



For exacting, heavy-duty requirements you can rely on IRC Power Wire Wounds for balanced performance in every characteristic. Being full-sized, they can operate continuously at full rating. Derating in high ranges is unnecessary.

IRC Power Wire Wounds are available in a full range of ratings, sizes and terminal types. 91 new ranges have just been added. Next time you step up to your distributor's counter—stock up on IRC Power Wire Wounds.



INTERNATIONAL RESISTANCE CO.

401 N. Broad Street, Phila. 8, Pa.
In Canada: International Resistance Co., Ltd., Toronto, Licensee



YES! We're listed in the **RED BOOK** Looking for the correct IRC replacement controls for any receiver manufactured from 1918 to 1948? Just refer to the Radio Industry **RED BOOK!**

Signal Corps Jack Box



BC-1366 or 366 Jack Box. Contains Mic. Jack, volume control, 5 position 2 gang rotary switch, 11 contact bayonet plug and receptacle. All nicely assembled in a neatly finished metal box 3 3/16" W x 4 3/8" H x 2 3/16" D. Lots of uses in the Ham shack, lab., or on mobile installations. A sensational buy at only 79c each, postpaid, or 10 for \$6.95 postpaid.

Meter Bargain 77¢



Brand new 3-0-3, DC voltmeter 2" round case. Meter has 450 ohms resistance (150 ohms per volt). (Add 15c each to cover postage and handling.)

Citizen Band Phantom Antenna 85¢



A transmitting antenna, for use on approximately 450 MC. Complete with standard coax connector. A weather-proof unit. (Add 25c to cover handling and postage.)

C.R. Tubes

- 3 CP 1 (Ind. Screen) .95
- 3 DP 7-A (Ind. Screen) .95
- 3 FP 7-A ----- 1.35
- 3 HP 7 ----- 1.45
- (add 25c each to cover postage and handling)
- 5 FP 7 ----- 1.75
- 5 CP 1 ----- 1.95
- 5 BP 1 ----- 2.45
- 5 HP 1 ----- 2.45
- (add 35c each to cover postage and handling)
- 7 BP 7 ----- 2.65
- 7 CP 1 ----- 3.25
- (add 40c each to cover postage and handling)
- 9 GP 7 ----- 3.50
- (Shipped express, charges collect)

It's 1948 Saving Season!



2 volt Battery \$1.25

Brand new, compact, spillproof built-in hydrometer, group several together to get higher voltages. Fully guaranteed. Shipped dry, add 35c to cover postage and handling.



BC 616 Control Box

Originally used with the command set between Modulator BC456A and Control Box BC451A. Contains 3, 24 volt relays and other parts an excellent buy at only \$1.39 postpaid.



By Bendix \$1.29 Postpaid

Model 3616, makes an excellent set up for an intercom. set. Contains 3 multiple type wafer switches, one panel type fuse, one volume control, one master 2 pole double throw switch, one lock type sending and receiving telephone key, one local remote transmitter control, one single pole switch, one 24-volt Leach Relay with 2 contacts.



69¢ Post Paid

Western Electric Extension Control Box, Type CW 23098. Complete with mounting plate. All new in original cartons. Contains one 50000 ohm reostat, 1 toggle switch, one phone jack, one microphone jack, one test key, and one neon indicator lamp.



BC 450

Triple remote control box for Command Receivers (SCR 274 N Series). Equipped with 3 tuning dials, 3 volume controls, and 6 selector switches. Used, but in excellent condition, a steal at only \$1.50 ea. (Add 25c to cover postage and handling.)



NEW METERS

Brand new Bowers D.C. Volt meter 0 to 9 volts in 2" case with 2 3/4" Flange ----- each .99c
Brand new Bowers D.C. Ammeter 0 to 100 amp scales (600 ma. movement with 100 amp shunt) same case as volt meter each .99c
Add 20c each to cover postage and handling

Special Bargain

Westinghouse, Oxygen Flow Indicator - MK II. New in original cartons, 49c, add 15c to cover postage and handling.



Loops \$3.95

Used primarily on aircraft & Marine ADF Systems, Loop LP-21-A contains an electric motor and selsyn. These loops have been removed from salvage aircraft, but are guaranteed to be in excellent working condition.

Shipped Express Collect

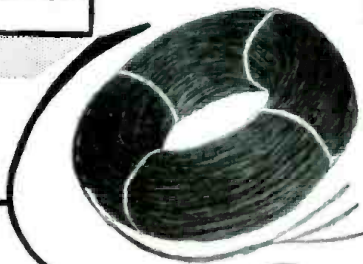

525 Feet Brand New Telephone Wire **Only 2.99**

3 conductor braided insulated copper and steel telephone wire. It is of copper for conductivity and steel for strength. Worth at least 3c per foot, yet due to an exceptional buy we can now offer it at less than 1c per foot.

(Shipped express charges collect)

Surplus Tubes

All New, All Postpaid

- 8012 \$1.69
- 1626 \$.35
- 705-A \$1.19
- 211 \$.69

READ THIS

And They're Postpaid

Antenna Relay Unit BC-442A or RE-2/ARC-5. Originally used on Command Set (SCR-274). Contains an antenna change-over relay, a 19 1/2 millivolt meter, with an external 3/4 amp. thermocouple. The meter scale reads R.F. current on a linear scale calibrated 0 to 10. A truly sensational buy at only \$1.95

All merchandise subject to prior sale, minimum order \$2.00, No C.O.D. orders accepted. Michigan residents must add 3% State sales tax.

IMPORTANT

N. SILVERSTINE CO.

6532 EAST McNICHOLS ROAD DETROIT 12, MICHIGAN

"Seven Acres of Surplus"

Set by Set, Volume by Volume - PHOTOFACT Boosts Your Profits!

Build the Service Data library that helps you earn more. Have at your finger-tips the most accurate, uniform and practical service data ever produced—everything you need for easier, more profitable work. From the moment you get them, PHOTOFACT Folder Sets and Volumes pile up increasing profits for you, month after month, year after year. For success in servicing, for bigger earning power, you owe it to yourself to keep your PHOTOFACT library up-to-date!

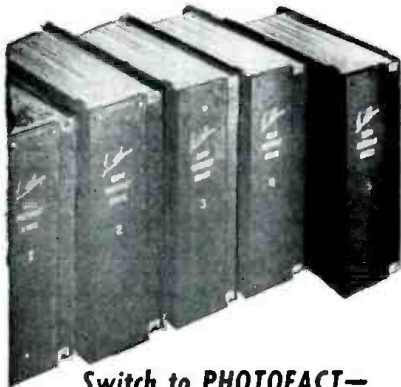

NOW! PHOTOFACT VOLUME 5 ON SALE AT YOUR JOBBER'S TODAY!

Latest addition to the famous PHOTOFACT Volume series—brings your file of postwar receiver service data right up to December 1948! Most accurate and complete radio data ever compiled—preferred and used daily by thousands of Radio Service Technicians. Everything you need for faster, more profitable servicing: Exclusive Standard Notation Schematics; photo views keyed to parts lists and alignment data; complete parts listings and proper replacements; alignment, stage gain, circuit voltage and resistance analysis; coil resistances; record changer service data, etc. Order Volume 5 today—keep ahead with Photofact—the *only* Radio Service data that meets your *actual* needs!

- Vol. 5. Covers models from July 1, 1948 to Dec. 1, 1948
- Vol. 4. Covers models from Jan. 1, 1948 to July 1, 1948
- Vol. 3. Covers models from July 1, 1947 to Jan. 1, 1948
- Vol. 2. Covers models from Jan. 1, 1947 to July 1, 1947
- Vol. 1. Covers all postwar models up to Jan. 1, 1947

Switch to PHOTOFACT—
the Best Service Data Buy
You'll Ever Make!

Your Price
Each Volume, **\$18.39**
In DeLuxe Binder

Stay Ahead of the Game with PHOTOFACT Folder Sets . . .

You can't afford to miss a single PHOTOFACT Folder Set! You get not only the most complete and accurate Radio Service Data ever compiled—but you keep up with fast-moving developments. Have all the advantages that make PHOTOFACT indispensable to thousands of Service Technicians—PLUS—exclusive new TV Folders on popular Television receivers—the invaluable TV Course (don't miss the sections on wave pattern trouble-shooting, and antennas)—full data on the latest Record Changers—all this in addition to full coverage of current radio models. Subscribe regularly to PHOTOFACT Folder Sets—to make your work easier, quicker, more profitable. Issued two Sets per month. Subscribe at your Jobber today. **\$1.50 PER SET ONLY**.....

You'll Use These Practical Books Every Single Working Day!

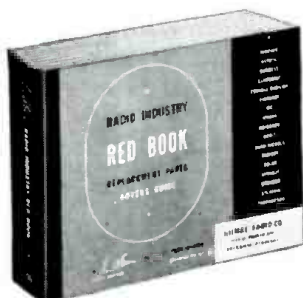

The Radio Industry RED BOOK

NOW—stop wasteful hunting through dozens of incomplete parts manuals. The RED BOOK tells you *in one volume* what you need to know about replacement parts for approximately 17,000 sets made from 1938 to 1948. Includes complete, accurate listings of all 9 major replacement components—not just one. Lists correct replacement parts made by 17 leading manufacturers—not just one. Covers original parts numbers, proper replacement numbers and valuable installation notes on: Capacitors, Transformers, Controls, IFS, Speakers, Vibrators, Phono-Cartridges, Plus—Tube and Dial Light data, and Battery replacement data. 448 pages, 8 1/2 x 11; **\$3.95** sewed durable binding. **ONLY**.....

1947 Changer Manual

Complete, accurate service data on over 40 Postwar Record Changer models. Shows exploded views, photos from all angles. Includes change cycle data, adjustment notes, service hints, complete parts lists. PLUS—complete data on leading Wire, Ribbon, Tape and Disc Recorders. 400 pages; hard cover; opens flat. Order now! **\$4.95 ONLY**.....



Tube Placement Guide

Shows you exactly where to replace each tube in 5500 radio models, covering 1938 to 1947 receivers. Each tube layout is illustrated by a clear, accurate diagram. Saves time—eliminates risky hit-and-miss methods. 192 pages; handy index. **ONLY**.. **\$1.25**



Dial Cord Stringing Guide

The book that shows you the *one right way* to string a dial cord. Here, in one handy pocket-sized book, are all available dial cord diagrams covering over 2300 receivers, 1938 through 1946. Makes dial cord restringing jobs quick and simple. **\$1.00 ONLY**.....



FREE Photofact Cumulative Index

Send for the FREE Cumulative Index to PHOTOFACT Folders covering *all* postwar receivers up to the present. You'll want this valuable reference guide to the Radio Service Data preferred and used by thousands. Helps you find the Folders you want in a jiffy. Get this FREE Index at your Jobber or write for it now.



BOOST YOUR EARNING POWER!

Mail This Order Form to Your Parts Jobber Today or send to HOWARD W. SAMS & CO., INC. 2924 E. Washington St., Indianapolis 7, Ind.

- My (check) (money order) for \$.....enclosed.
- Send following Photofact Volumes: Vol. 5.
 Vol. 4. Vol. 3. Vol. 2. Vol. 1. (\$18.39 each).
 Send the RED BOOK. \$3.95 per copy.
 Automatic Record Changer Manual. \$4.95.
 Tube Placement Guide. \$1.25
 Dial Cord Stringing Guide, \$1.00
 Send FREE Photofact Cumulative Index.

Name.....

Address.....

City.....State.....

HOWARD W. SAMS & CO., INC.
INDIANAPOLIS 7, INDIANA



Get YOUR All-Plastic Cabinet by Purchasing the Serviceman's Resistor Assortment \$10⁰⁰

It's easy to find the right resistor... fast... in this handy, handsome, all-plastic OHMITE cabinet. Compact—only 9" x 5 1/4" x 4 3/4"—its 40 compartments are factory packed with a carefully selected serviceman's assortment of 125 individually marked, 1/2-watt "Little Devil" resistors in the 40 values from 10 ohms to 10 megohms most frequently used. And, you pay only the regular price of the resistors... nothing extra for cabinet.



See Your Distributor

BROWN DEVIL

Vitreous Enamel Resistors



A favorite with servicemen. Easily mounted by its tinned wire leads. In sizes 5, 10, and 20 watts. Tol. $\pm 10\%$.

DIVIDOHM

Adjustable Resistors



Vitreous enameled. 10 to 200 Watts. Ideal for securing odd resistance values.

OHMITE MANUFACTURING CO.
4896 Flournoy Street • Chicago 44, Ill.

Be Right with

OHMITE

RHEOSTATS • RESISTORS • TAP SWITCHES

W. L. Parkinson, manager of the Technical Service Section of *General Electric*, predicts a sale of approximately 120,000 television receivers in the New York metropolitan market within the next six months. He stressed the point that there must be an increase in dealer service facilities if this market is to be satisfied.

"The sale of television receivers," he said, "is directly dependent upon the service provided. Sales can only increase as fast as the radio service industry assumes the service obligation. The problem now is not how fast can we sell television receivers, but how fast can we, the service industry, install and provide service."

"We know that the time is not too far distant when the need for factory supervised service will no longer exist. We know that the wholesale distributor also is eager to turn the obligation over to the service industry. In the past two years, the service industry has made great gains in technical knowledge, and the manufacturers have invested many thousands of dollars in television training for the service industry. However," he concluded, "no one in the industry can predict just when the service industry will be able to take over full responsibility for television receiver installation and maintenance."

Trend toward heavy fall production of radio and television receivers was reflected in August as TV set output again reached a new monthly peak, the *Radio Manufacturers Association* reported.

RMA member-companies manufactured 64,953 television receivers in August for a new monthly record and an increase of almost 10,000 over the July output. Average weekly production of 16,238 TV sets in August showed an increase of 51 per cent over the weekly production for the first half of this year. FM-AM set production by RMA member-companies totalled 110,879 in August to record the largest output of this type of receiver since last March. Radio receiver production of all types totalled 870,044 in August compared with 627,349 in July. Production of automobile and portable radios aggregated 256,594 and 178,323, respectively.

Paul V. Galvin, president of *Motorola, Inc.*, Chicago, has announced that as a result of its recent purchase of the "inventory and certain assets" of the Car Radio Division of International Detrola Corp., Detroit, *Motorola* will now for the first time supply sets to automobile manufacturers. For 20 years, the *Motorola* Company has sold automobile radios to consumers only.

The Department of Commerce reported that during the month of July sales by independent radio stores throughout the nation were 2 per cent below July, 1947.

Westinghouse Electric Corp. has disclosed a plan called the *Westinghouse*

Equity Plan, designed to encourage local banks to handle the financing of radio and electrical appliances purchased by local Westinghouse dealers and their customers.

L. H. Lund, vice-president and treasurer of *Westinghouse*, said that banks participating in the program would be afforded many protective assurances, not before available.

The plan, which is being sent to the nation's 15,000 banks, "has been carefully scrutinized by sixteen of the leading consumer credit bankers of the country, acting as an advisory council to *Westinghouse*."

"To the consumer, these agreements mean more equitable financing of the appliances and radios he buys as the result of economies the plan makes possible for the local banks," explained Mr. Lund. "They mean also that the consumer encounters less 'red tape' in getting his installment purchase arranged."

Copies of the 1948 complete roster of *The Representatives of Radio Parts Manufacturers, Inc.*, are available and will be furnished without charge to any manufacturer of radio and electronic parts and equipment who sends his request on his business letterhead to L. C. McCarthy, Secretary of The Representatives, 9 South Clinton Street, Chicago 6, Illinois.

The 72-page booklet, prepared by the Industry Relations Committee, lists more than 350 members of The Representatives alphabetically and by geographical regions.

The Department of Commerce reports independent radio and musical instrument dealers showed an average gain in sales of 5% during the first six months of 1948 over a similar period last year.

John Pell, manager of television service for the *Philco Corp.* of Philadelphia, has announced that the company has started a long-term program to train radio servicemen in the technique of television servicing.

"All Philco distributors in television cities are co-operating in this program aimed at developing many additional thousands of competent technicians familiar with all phases of servicing modern television receivers and in proper antenna installation, whether outdoor or indoor," Mr. Pell stated.

"The new course is available to all servicemen who have a sound basic technical knowledge of radio. These men include dealers, service managers and servicemen employed by dealers and independent servicing contractors."

"The Philco training course in television is designed to make it easy for every serviceman or technician with a fundamental knowledge of radio and preferably some practical experience, to obtain the technical schooling necessary to keep pace with the latest developments in television."

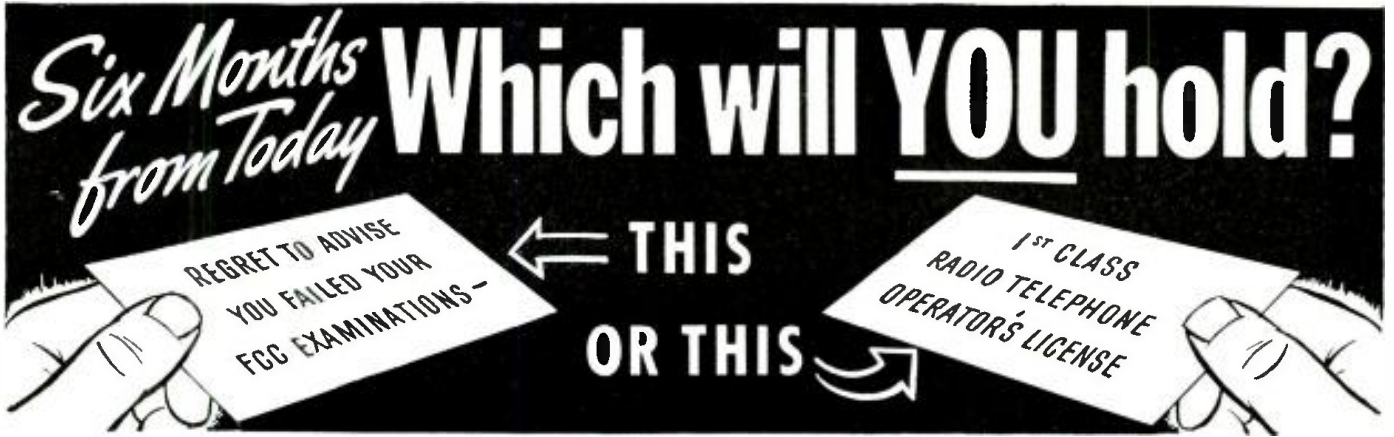

WANT YOUR FCC COMMERCIAL LICENSE IN A HURRY?

Get Your "Ticket" in a FEW SHORT WEEKS! It's EASY when you use CIRE Simplified Training and Coaching AT HOME in SPARE TIME

Thousands of new jobs are opening up—FM, Television, Mobile Communication Systems. These are only a few of the radio fields which require licensed radio technicians and operators.

Get your license without delay. Let Cleveland Institute prepare you to pass FCC license examinations, and hold the jobs which a license entitles you to, with CIRE streamlined, post-war methods of coaching and training.

Your FCC Ticket Is Recognized in ALL Radio Fields as Proof of Your Technical Ability

More than ever before an FCC Commercial Operator License is a sure passport to many of the better paying jobs in this New World of Electronics. Employers always give prefer-

ence to the license holder, even though a license is not required for the job. Hold an FCC "ticket" and the job is yours!

Hundreds of Satisfied, Successful Students

"Transmitter engineering is great, especially in the job I am on. Thanks again for all you have done, and you can take the credit for the fact that my 'ticket' is now posted on the wall of a 1000 Watt broadcast station." Student # 3678N12

"I now hold ticket number P-10-3787, and holding the license has helped me to obtain the type of job I've always dreamed of having. Yes, thanks to CIRE, I am now working for the Civil Aeronautics Administration as Radio Maintenance Technician, at a far better salary than I've ever had before. I am deeply grateful." Student # 3319N12

"I was issued license number P-2-11188 on November 4, 1947, at New York, N.Y. The next day I was signed on board a tanker as Radio (telegraph) Operator/Purser. Besides radio operating on board ship I handle the payroll, etc., which is all over-time and brings my monthly pay up to between \$500 and \$650." Student # 2355N2

"I take great pleasure in informing you that I have taken the examination for radio telephone first class license on June 29th, and passed and have received my license. I am now working at WCXII, a local 250 watt station." Student # 3171N12

FREE BOOKLET— Tells you the Government requirements for all classes of FCC commercial licenses. (Does not cover Amateur License examinations.) Use coupon below for Booklet B.

OTHER

Cleveland Institute Home Study Courses Offer Complete Technical Radio Training from Law-Level to College-Level, for the Radioman with Practical Experience!

COURSE A — Master Course in Radio Communication

A complete course covering the technical fundamentals of radio-electronics, for the radioman who wants a general review. Includes preparation for Broadcast station employment.

COURSE B — Advanced Course in Radio Communication Engineering

A genuine college-level radio engineering course, completely mathematical in treatment. For the advanced radioman with considerable practical experience and training.

COURSE C — Specialized Television Engineering

An advanced college-level course for the radioman who has had formal training equivalent to A and B.

COURSE D — Advanced Radio Telephony

An advanced, specialized course covering broadcast station engineering and operation. Without preliminary preparatory fundamentals, this course enters immediately into the heart of the subject matter. Covers the engineering knowledge and the technical duties required of the studio control operator, the master control operator, and the transmitter operator.

FREE CATALOG — Describes all Cleveland Institute home study courses—tells of CIRE unique, post-war methods of training. Use coupon below for Catalog A.

**How To Pass
FCC
LICENSE
EXAMINATIONS**

CLEVELAND INSTITUTE
OF
RADIO ELECTRONICS
Terminal Tower - Cleveland, Ohio

HOW TO PASS Commercial Radio Operators' FCC LICENSE EXAMINATIONS...

CLEVELAND INSTITUTE OF RADIO ELECTRONICS
RE-12 4900 Building, CLEVELAND 3, OHIO

CLEVELAND INSTITUTE OF RADIO ELECTRONICS
RC-12 4900 BUILDING, CLEVELAND 3, OHIO

Gentlemen: Please send me your Booklet B, "HOW TO PASS FCC COMMERCIAL LICENSE EXAMINATIONS," and information about your home study course for preparation for FCC License Examinations. (Does not cover Amateur License Examinations.)

Please send me your Catalog A, describing all of your home study radio electronics courses. I desire training in course A, B, C, D.

NAME

ADDRESS

CITY ZONE STATE

NO OBLIGATION—NO SALESMEN

Approved for Training Under "G-1 Bill of Rights"

Don't Delay—Write Today!

Features
THAT MAKE

HEATHKITS

HEATHKIT FM and TELEVISION SWEEP GENERATOR KIT

A necessity for television and FM. This Heathkit completely covers the entire FM and TV bands 2 megacycles to 230 megacycles. The unit is 110V 60 cy power transformer operated. Uses two 6J6 tubes, two 6C4 tubes and a 6X5 rectifier. An electronic sweep circuit is incorporated allowing a range of 0 to 10 MC. A sawtooth horizontal sweeping voltage and phase control are provided for the oscilloscope.

The coils are ready assembled and precision adjusted to exact frequency. As in all Heathkits, the best of parts are supplied, Mallory filter condenser, zero coef. ceramic condensers, all punched and formed parts, grey crackle cabinet, 5 tubes, test leads, etc. Better get it built now and be ready for the FM and TV business. Shipping wt. 6 lbs.



\$24.50

Nothing ELSE TO BUY...

KITS THAT FIT

Heathkit chassis are precision punched to fit the quality parts supplied. The grey crackle aluminum cabinet and the two color panels are die punched to assure proper fitting. Many builders have written marveling at the ease with which assembly can be done. The chassis are specially engineered for easy assembly and wiring—there are no small tight corners which cannot be reached—the ends of the chassis are left open in order that installation of parts and soldering can be done with both hands.

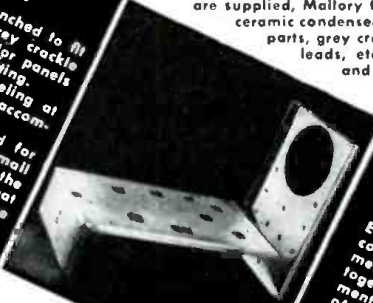

COMPLETE INSTRUCTION MANUALS

Everyone is pleased at the thorough instructions covering the assembly of each Heathkit instrument. Every detail of the assembly is covered together with sections on the use of the instrument and trouble shooting instructions in case of difficulty. Actual photos of the assembled instrument enable fast and accurate assembly. Clear schematics and pictorial diagrams of the confusing parts such as rotary switches enable the wiring to be completed quickly.



Heathkit SIGNAL GENERATOR KIT...

\$19.50

Nothing ELSE TO BUY



Every shop needs a good signal generator. The Heathkit fulfills every servicing need, fundamentals from 150 Kc to 30 megacycles with strong harmonics over 100 megacycles covering the new television and FM bands. 110V 60 cycle transformer operated power supply.

400 cycle audio available for modulation or audio testing. Uses 6SN7 as RF oscillator and audio amplifier. Complete kit has every part necessary and detailed blueprints and instructions enable the builder to assemble it in a few hours. Large easy to read calibration. Convenient size 9" x 6" x 4 3/4". Shipping weight 4 1/2 lbs.

Heathkit SINE AND SQUARE WAVE AUDIO GENERATOR KIT

\$34.50

The ideal instrument for checking audio amplifiers, television response, distortion, etc. Supplies excellent sine wave 20 cycles to 20,000 cycles and in addition supplies square wave over same range. Extremely low distortion, less than 1%, large calibrated dial, beautiful 2 color panel, 1% precision calibrating resistors. 110V 60 cycle power transformer, 5 tubes, detailed blueprints and instructions. R.C. type circuit with excellent stability. Shipping Wt. 15 lbs.



Nothing ELSE TO BUY

HEATHKIT HIGH FIDELITY AMPLIFIER KIT

\$14.95

Build this high fidelity amplifier and save two-thirds of the cost. 110V 60 cy transformer operated. Push pull output using 1619 tubes (military type 6L6's), two amplifier stages using a dual triode (6SL7), as a phase inverter give this amplifier a linear reproduction equal to amplifiers selling for ten times this price. Every part supplied; punched and formed chassis, transformers (including quality output to 3-8 ohm voice coil), tubes, controls, and complete instructions. Add postage for 20 lbs.

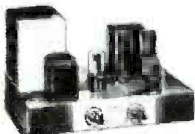

12" PM Speakers for above..... 6.95
Mahogany Speaker Cabinet 14 1/2" x 14 1/2" x 8" 8.75

110V A.C. MILITARY RECEIVER POWER SUPPLY KIT



\$5.95

Ideal way to convert military sets. 110V 60 cy. transformer operated. Supplies 24 Volts for filament—no wiring changes inside radio. Also supplies 250V D.C. plate voltage at 50-60 MA. Connections direct to dynamotor input. Complete with all parts and detailed instructions. Shipping wt. 6 lbs.

110 V. A.C. TRANSMITTER POWER SUPPLY KIT

For BC-645, 223, 522, 274N's, etc. Ideal for powering military transmitters. Supplies 500 to 600 Volts at 150 to 200 MA plate, 6-3 CT. at 4 Amps, 6.3 at 4 Amps, and 12V at 4 Amps. Can be combined to supply 3-6-9-12 or 24 Volts at 4 Amperes. Kit supplied complete with husky 110V 60 cycle power transformer, 5U4 rectifier, oil filled condensers, cased choke, punched chassis, and all other parts, including detailed instructions. Complete—nothing else to buy. Shipping Wt. 22 lbs.



\$14.50

HEATHKIT CONDENSER CHECKER KIT

\$19.50

Nothing ELSE TO BUY



Checks all types of condensers, paper mica—electrolytic—ceramic over a range of .00001 MFD to 1000 MFD. All on readable scales that are read direct from the panel. NO CHARTS OR MULTIPLIERS NECESSARY. A condenser checker anyone can read without a college education. A leakage test and polarizing voltage of 20 to 500 volts provided. Measures power factor of electrolytics between 0% and 50%. 110V 60 cycle transformer operated complete with rectifier and magic eye tubes, cabinet, calibrated panel, test leads and all other parts. Clear detailed instructions for assembly and use. Why guess at the quality and capacity of a condenser when you can know for less than a twenty dollar bill. Shipping wt. 7 lbs.



The **HEATH COMPANY**

BENTON HARBOR 20, MICHIGAN

IDEAL TEST INSTRUMENTS

HEATHKIT VACUUM TUBE VOLTMETER KIT

Everything you want in a VTVM. Shatterproof solid plastic meter face, automatic meter protection in burn-out proof circuit, push pull electronic voltmeter circuit assuring maximum stability. Linear DC and AC scales. Complete selection of voltage ranges starting with 3 Volts full scale up to 1,000 Volts. Isolated DC test prod for signal tracing and measurements of voltage while instrument is in operation. An ohmmeter section accurately measuring resistance of 1/10 ohm to one billion ohms with internal battery. Extremely high input resistance 11 megohms on all ranges DC and 6.5 megohms on AC. All these features and many more are the reasons hundreds of radio and television schools are using Heathkit VTVM's and recommending them to all students. Like all Heathkits, the VTVM kit is complete, 110V 60 cy power transformer, 500 microamp meter, tubes, grey crackle cabinet, panel, test leads, 1% ceramic precision divider resistors and all other parts. Complete instruction manual. Better start your laboratory now, and enjoy it all winter. Shipping Wt. 8 lbs.

*Nothing
ELSE TO
BUY!*
\$24⁵⁰

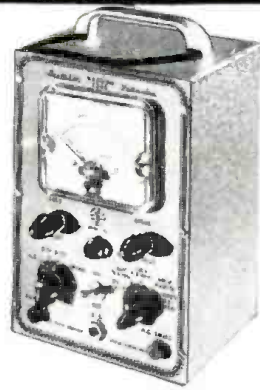

HEATHKIT SIGNAL TRACER KIT

Reduces service time and greatly increases profits of any service shop. Uses crystal diode to follow signal from antenna to speaker. Locates faults immediately. Internal amplifier available for speaker testing and internal speaker available for amplifier testing. Connection for VTVM on panel allows visual tracing and gain measurements. Also tests phonograph pickups, microphones, PA systems, etc. Frequency range to 200 MC. Complete ready to assemble. 110V 60 cycle transformer operated. Supplied with 3 tubes, diode probe, 2 color panel, all other parts. Easy to assemble, detailed blueprints and instructions. Small portable 9" x 6" x 4 1/4". Wt. 6 pounds. Ideal for taking on service calls. Complete your service shop with this instrument.

\$19⁵⁰

Nothing ELSE TO BUY

HEATHKIT 3-TUBE ALL-WAVE RADIO



\$8.75

110-Volt AC Operation
An ideal way to learn radio. This kit is complete ready to assemble, with tubes and all other parts. Operates from AC. Simple, clear detailed instructions make this a good radio training course. Covers regular broadcasts and short wave bands. Plug-in coils. Regenerative circuit. Operates loud speaker. Add postage for 3 lbs. \$8.75
HS 30 Headphones per set.....\$1.00
2 1/2" Permanent Magnet Loudspeaker 1.95

INTERPHONE 2-WAY CALL SYSTEM KIT



\$14.50

Ideal call and communication system for homes, offices, factories, stores, etc. Makes excellent electronic baby watcher easy to assemble with every part supplied including simple instructions. Distance up to 1.5 mile. Operates from 110V A.C. 3 tubes, one master and one remote speaker. Shipping Wt. 5 lbs.

Heathkit ELECTRONIC SWITCH KIT DOUBLES THE UTILITY OF ANY SCOPE

An electronic switch used with any oscilloscope provides two separately controllable traces on the screen. Each trace is controlled independently and the position of the traces may be varied. The input and output traces of an amplifier may be observed one beside the other or one directly over the other illustrating perfectly any change occurring in the amplifier. Distortion—phase shift and other defects show up instantly. 110 Volt 60 cycle transformer operated. Uses 5 tubes (1—6X5, 2—6SN7's, 2—6SJ7's). Has individual gain controls, positioning control, and coarse and fine sweeping rate controls. The cabinet and panel match all other Heathkits. Every part supplied including detailed instructions for assembly and use. Shipping and weight 11 lbs.



\$34⁵⁰

*Nothing
ELSE TO
BUY*

COMPLETE KITS

When you receive your Heathkit, you are assured of every necessary part for the proper operation of the instrument. Beautiful cabinets, handles, 2 color panels, all tubes, test leads, quality rubber lining part of the instrument, quality printed and cords and plugs, rubber feet for each instrument, all scales and dials ready printed and calibrated. Every Heathkit is 110V 60 cy. power transformer, operated by a husky transformer especially designed for the job.

New 1948

HEATHKIT 5" OSCILLOSCOPE KIT

A necessity for the newer servicing technique in FM and television at a price you can afford. The Heathkit is complete, beautiful two color panel, all metal parts punched, formed and plated and every part supplied. A pleasant evening's work and you have the most interesting piece of laboratory equipment available.

Check the features—large 5" 5BP1 tube, compensated vertical and horizontal amplifiers using 6SJ7's, 15 cycle to 50 M cycle sweep generator using 884 gas triode, 110V 60 cycle power transformer gives 1100 volts negative and 350 volts positive.

Convenient size 8 1/2" x 13" high, 17" deep, weight only 26 pounds.

All controls on front panel with test voltage and ext. syn. post. Complete with all tubes and detailed instructions. Shipping weight 35 pounds. Order today while surplus tubes make the price possible.

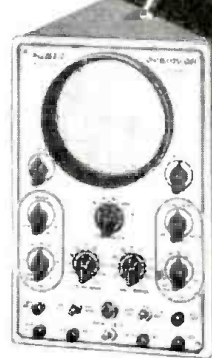

*Nothing
ELSE TO BUY*
\$39⁵⁰

ORDER DIRECT FROM THIS AD.
WE WILL SHIP C.O.D.
Add Postage for Weight Shown

BEST OF PARTS

You will find many famous names on the parts in your Heathkit. Mallory switches and filter condensers, Chicago Transformer Corporation and Electrical Assembly Transformers, Centralab Potentiometers, Golden Cable, IRC and Allen Bradley resistors, Eby Bipolar contacts and many other quality parts. The finest of parts are used to assure long trouble-free service from Heathkits.



Buy HEATH SURPLUS Now!

ALL QUANTITIES LIMITED SUBJECT TO PRIOR SALES

APN/1 RADIO ALTIMETERS



\$34.50

NO. 200. The last chance to get a complete new 14 tube radio altimeter. Contains 420 Mc. transmitter and receiver, power supply, range switches, two antennas, meter indicator, oil plugs and instruction manual. This unit makes excellent amateur station as it is right in the band. Shipped in original export crate. Weight 87 lbs.

G.E. BC 375 TUNING UNIT

NO. 203. Model TU10B covers 10 Mc. to 12.5 Mc. New complete with aluminum cabinet. The best buy of surplus. Over \$30.00 worth of new variable condensers, coil, dials, switches, etc. Add postage for 20 lbs.



\$2.49

G.E. 50 AMP CIRCUIT BREAKER

NO. 204. New General Electric 50 Amp 220 Volt AC circuit breakers. 100 Amp when used on 110V. Add postage for 4 lbs.



\$2.95

EACH - 3 FOR \$7.50

BC 347 AIRCRAFT INTERPHONE AMPLIFIER

NO. 205. Interphone amplifier contains 6F8 tube, Ouncer transformers, diagrams, etc. in aluminum cabinet. Add postage for 4 lbs.



\$2.95

274N COMMAND SET ACCESSORIES

NO. 238. 5" PM Speaker with output transformer matching head-phone output.....\$2.80
 NO. 239. Dual receiver rack FT277A with connecting plugs.....\$1.00
 NO. 240. Single transmitter rack FT234A.....\$1.00
 NO. 241. Spline shaft for tuning command receivers. Allows use of regular tuning knob on BC 453-4-5 receivers.....\$.39



BC 451 CONTROL BOX

NO. 236. Control box for 274N transmitters. Contains proper c-w voice switch, 4 channel switch, power switch, mike jack and telegraph key. Add postage for 2 lbs.



\$1.95

METER SPECIAL

NO. 237. Brand new DeJur Model 312 0-800 M.A. D.C. Square 3" 0-10 M.A. basic meter with built in shunt. Probably the best buy ever offered in a surplus meter. Shipping Weight 1 lb.



\$2.95

A-62 ARMY PHANTOM ANTENNA

NO. 206. Contains tuning condenser, coil, resistors, tuning dial, tuning indicator, binding posts, steel case, useful for building amateur transmitter. Add postage for 8 lbs.



\$1.95

BENDIX MR9C COMPASS CONTROL UNIT

NO. 207. Tuning and control unit for Bendix MN 26 radio compasses contains tuning dial, band switch, crystal switch, AVC switch, volume control, fuses, phone jacks, etc. Shipping Weight 5 lbs.



\$9.50

BC731 CONTROL BOX

NO. 208. Excellent buy in motor control box. Size 8" x 10" x 5 1/2". Contains Weston 0-150V. AC 3 1/2" voltmeter, motor starting switch, 28 fuses all 30 Amp 110V. and 8 fuse holders. Fuses and holders alone worth the price. Shipping Weight 18 lbs.



\$7.95

BC 645 GENERAL ELECTRIC TRANSCEIVER



NO. 201. Complete 15 tube transmitter-receiver. Ideal for new citizens band 460 Mc. for communication between office and car, home, boat, etc. Convention article in August ELECTRONICS Magazine. Brand new in original G.E. cartons with tubes. Add postage for 25 lbs.

\$19.50 ... 2 for \$35.00

ACCESSORIES FOR BC 645

PE101C Dynamotor for car use.....\$ 3.95
 110V 60 Cycle Power Supply for home or office use.....\$14.50

T32 TABLE MICROPHONE

NO. 210. One of the Army's best. Built by Kellogg, ideal for factory call system, public address, amateur use. Brand new in original cartons. Add postage for 5 lbs.



\$2.95

MINIATURE ELECTRIC MOTOR

NO. 211. Tiny Delco motor only 1" x 1 1/4" x 2" 10,000 RPM. Operates from 6 to 24 V. Excellent for models. Add postage for 1 lb.



\$2.95

P. E. 103 6 VOLT DYNAMOTOR

NO. 212. Dynamotor only from PE 103 power supply. Input 6 or 12 Volts, output 500 Volts at 160 MA. Brand new original cartons. Shipping Weight 29 lbs.



\$5.95

G. E. 1,000 VOLT 350 MA DYNAMOTOR

NO. 213. An ideal dynamotor for mobile operation in taxicabs, police cars, sound systems and amateur stations. Supplies above voltage from 12 Volts at 500V. at 350 MA from 6 Volts. Complete with starting relay, and fuses. New. Our Dynamotor A. Shipping Weight 72 lbs.



\$5.95

DM-36 DYNAMOTOR

NO. 215. Western Electric 24 Volt input, 220V. at 60 MA out. With filter assembly. Shipping Weight 6 lbs.

\$2.95

G.E. BC 306 ANTENNA TUNING UNIT

NO. 231. Matches any aerial to 150 Watt transmitter, used on BC 375. Brand new. Add postage for 20 lbs.



\$2.95

W.E. BC456 MODULATOR

NO. 217. Modulator from 274N command transmitters contains 3 husky relays, 3 tubes, VR150, 12J5 and 1625. Brand new. Add postage for 11 lbs.



\$3.95

BE 77 TELETYPE TEST SET

NO. 218. Contains zero center volt-milliammeter, switches, relays, voltage divider resistors, neon indicator, etc. Excellent foundation for radio tester. Shipping Weight 10 lbs.



\$7.95

BENDIX MN 20E DIRECTION FINDER LOOP

NO. 219. Ring type loop excellent for use on boat or aircraft. Extremely rugged construction. Low impedance manual type. Add postage for 8 lbs.



\$9.95 EACH

LP 18C DIRECTION FINDER LOOP

NO. 220. Motor driven streamline pod type loop used on automatic direction finders. Has Selsyn transmitter and motor, fits most military direction finders. Add postage for 20 lbs.



\$14.50 EACH

KIT SPECIALS

POTENTIOMETERS
 NO. 232. Kit of 10 excellent shaft type potentiometers good variety **\$1.95**

SOCKETS
 NO. 233. Kit of 20 high quality sockets several different types. **\$1.00**

RCA NAVY COMMUNICATION RECEIVER

NO. 202. The last of these beautiful RCA sets. Covers 195 Kc. to 9.1 Mc. continuously. Supplied complete with tubes, control box, tuning unit, 24 Volt dynamotor, band change motor, plugs and circuit diagram. Superheterodyne circuit covers aircraft, broadcast, short wave, marine, foreign broadcasts. Has sharp or broad I.F.'s B.F.O., etc. Shpg. Wt. 30 lbs.



\$29.50

PE 125 TRANSMITTER POWER SUPPLY

NO. 223. Operates from 12 to 24 Volts and supplies 500 Volts at 160 MA. Extremely rugged construction used in Army tanks. Complete with fuses - relays - filters, etc. Ideal for boats. Shipping Weight 73 lbs.



\$12.95

FM PUSH BUTTON TUNER

NO. 224. Brand new ten push button tuning assembly from Army FM receiver. Contains 4 gang 100 MMF silver plated tuning condensers. Add postage for 10 lbs.



\$2.50 EACH

RG 8/U FLEXIBLE COAXIAL CABLE

NO. 225. Standard television lead in 52 ohm. Any length up to 1,000 ft. Add for postage.



4¢ PER FOOT

POWER TRANSFORMER Specials

NO. 226. Primary 117V. 60 cycle. Secondaries supply 746 V.C.T at 220 MA, 6.3V. at 4.5 A., and 5V. at 4A. Will handle 13 tube radio receivers. Supply is limited, order early. Shipping Weight 11 lbs. each.

\$3.95 ... 3 for \$9.95

OUTPUT TRANSFORMER

NO. 227. Push pull 6V6's to 6-8 ohm voice coil excellent characteristics. **3 for \$1.95**

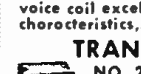

TRANSMITTER TRANSFORMER

NO. 228. The transformer for Transmitter Power Supply, 600 Volt at 200 MA and 4 Amp. filaments of 3 to 24 Volts. Also 5 Volts at 4 amperes for rectifier. Shipping Weight 12 lbs.



\$9.50

MILITARY POWER TRANSFORMERS

NO. 229. Convert your military receivers without rewiring the filament. "A" type supplies 500 VCT at 50 MA, 5V. at 2A. and 24V. at 1/2 A. "B" type supplies 500 VCT at 50 MA, 5V. at 2A. and 12V. at 1 Amp. State whether A or B type desired. Shipping Weight 4 lbs.



\$2.95

HOME WORKSHOP GRINDER KIT

NO. 230. Easily assembled 110V AC or DC ball bearing fully enclosed motor from Army surplus dynamotor. Purchaser to make simple changes and shaft extensions, detailed instructions and all parts supplied. Motor approximately 5,000 R.P.M. Ideal for tool-post grinder, flexible shaft pool, model drill press, saw. Shipping Weight 6 lbs.



\$3.95

HEARING AID HEADPHONES

NO. 216. The Army's best - eliminate flat ears and outside noise. Complete with transformer for conversion from low to high impedance. With cord and plug complete. Add postage for 1 lb.

\$1.00

TELEVISION CONDENSERS

NO. 221. Tube triple .2 MFD 4000 V.D.C. Filter used on Army radar. Ideal filter for H.V. television set. Add postage for 3 lbs.

NO. 222. G.E. Pyranol capacitor .25 MFD 6000 V.D.C. Porcelain insulated, an outstanding buy for high voltage filters. Add postage for 3 lbs.

\$3.95

\$3.95

HOW TO ORDER ... GIVE PART NUMBER AND DESCRIPTION ... ADD POSTAGE FOR WEIGHT SHOWN. NO ORDERS UNDER \$2.00 ... WE WILL SHIP C.O.D.

The HEATH COMPANY
 ... BENTON HARBOR 20, MICHIGAN

ELECTRONIC BARGAINS for EXPERIMENTERS and HOBBYISTS

ALL QUANTITIES LIMITED SUBJECT TO PRIOR SALES

STANCOR FILAMENT TRANSFORMER
 NO. 242. Heavy duty Stancor No. ST355 supplies 5V at 6 Amps, 5V at 3 Amps and 5V at 3 Amps from 220V 60 Cy. primary or 1/2 above from 110V. Cased type. Ship. **\$1.50**
 Wgt. 7 lbs. Each



G.E. THYRATRON TRANSFORMER
 NO. 243. New G.E. Transformer supplies 2.5V at 100 KVA, has 3KV insulation 100V 60 cy. primary. Shipping Wgt. 13 lbs. Each **\$9.50**

RCA SATURABLE REACTOR TRANSFORMER
 NO. 246. New RCA No. CRV30531 AC current 750 MA DC current 2 Amperes. Rated 1.75 henries. Shipping wgt. 4 lbs. Each **\$1.00**



12.6V POWER TRANSFORMER
 NO. 247. New cased 110 V 60 cy. Power Transformer. Supplies 440V Ct. at 60 MA, 6.3V at 2A, and 12.6V at 1 Amp. Excellent for military sets. Shipping Wgt. 6 lbs. Each **\$1.95**

RCA INPUT TRANSFORMER
 NO. 248. Heavy duty RCA No. CRV-30529. Input has primaries 600 to 200 and 25 ohms secondary 250,000 ohms C.T. Shipping Wgt. 2 lbs. Each **\$1.00**



REPLACEMENT POWER TRANSFORMER
 NO. 251. Excellent value transformers made by one of largest transformer companies. 110V 60 cy. Primary supplies 746 V Ct. at 150 MA. 5V at 4A and 6.3V at 4.5 Amps. Shipping Wgt. 7 lbs. Each **\$2.95**

FEDERAL POWER TRANSFORMER
 NO. 252. New cased 110V 60 cy. Power Transformer. Supplies 480V CT at 50 MA and 6.3 V at 2.1 Amps. A beautiful transformer. Shipping Wgt. 4 lbs. Each **\$1.50**



HEAVY DUTY 6-12-24 VOLT VIBRATOR
 NO. 253. A husky vibrator used an army transmitter. Rated 30 amperes at 6 Volts 220 cycle with contacts for 12 and 24 Volts, Synchronous type, has many industrial applications. Ship. Wgt. 3 lbs. Each **\$1.50**



4 CHANNEL PUSH BUTTON TUNER
 NO. 254. Permeability tuner from BC 728 containing RF, first detector, and oscillator coils. Covers 2 to 5 MC. Complete circuit diagram furnished. Shipping Wgt. 2 lbs. Each **\$2.50**



CONDENSER SPECIAL
 NO. 255. An ideal air filled power supply filter used in army 16 tube unit, has 2.5, 2.5 and 5 MFD all at 600V D.C. rating. Shipping Wgt. 3 lbs. Each **\$1.50**



TELEVISION CONDENSER
 NO. 256. Aerovox Myvol .05 MFD at 7500V. rating. Excellent television coupling condenser with mounting bracket. Shipping Wgt. 3 lbs. Each **\$3.50**



BC 746 TUNING UNIT
 NO. 257. Plug in transmitter tuning unit from army Walkie Talkie. Contains antenna and tank coils, tuning condenser, transmitting and receiving crystals. Ideal transmitter foundation. Shipping Wgt. 1 lb. Each **\$1.00**
 (Same as above except transmitter crystal in 80 meter amateur band \$2.50 each)



T30 THROAT MICROPHONE
 NO. 258. Makes excellent contact microphone for musical instrument or vibration pick-up. Shipping Wgt. 1 lb. \$1.00 each
 Extension cord with switch for above \$.50 each



BRAND NEW ARMY AIR FORCE ASTROGRAPH

NO. 259. The case of this unit makes the finest tool and service kit ever designed. Ply-wood construction, 14 x 11 x 10" high, with 8 covered compartments in the bottom for repair parts, leather handle, steel reinforced covers, hinged lid. Also excellent as case for radio phonograph, movie projector, camera, shell case, fishing kit, picnic kit, etc. The astrograph itself, (which cost the government \$125.00) makes an excellent contact printer, and can be used for a foundation for enlarger, strip map holder, etc. The case alone worth twice the give-away price of **\$3.95**



AN27/ARN5 ANTENNA
 NO. 260. Standard blind landing antenna system. Brand new in original crate. Ship. Wgt. 14 lbs. **\$9.50**



AS114/APT ANTENNA SYSTEM
 NO. 261. New blade type antenna complete with case assembly, in original carton. Shipping Wgt. 9 lbs. **\$7.50**

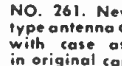

AS115/APT ANTENNA SYSTEM
 NO. 262. New blade type antenna complete with case assembly, in original carton. Ship. Wgt. 11 lbs. **\$7.50**



AT38A/APT RADAR ANTENNA
 NO. 263. New radar dome type antenna with mounting base and connections, in original carton. Ship. Wgt. 11 lbs. **\$14.50**



AN104A BLADE ANTENNA
 NO. 264. Standard blade antenna used on many military fighting planes with coaxial connection at base. Shipping Wgt. 3 lbs. **\$1.50**



BENDIX MT51C TRANSMITTER CONTROL BOX
 NO. 235. Contains channel switch, emission switch, send receive switch, power switch and indicators for Bendix aircraft transmitters. Ship. Wgt. 3 lbs. **\$5.50**



BC 670B REMOTE CONTROL BOX
 NO. 265. Motor starting control box has starting and stopping switch, indicator, cable and plug. Wooden case Ship. Wgt. 6 lbs. Each **\$1.95**



BK 22 RELAY ASSEMBLY
 NO. 266. Used on SCR 269 Radio Compasses. Contains stepping and control relays - junction box of aluminum. Brand new. Ship. Wgt. 7 lbs. Each **\$3.95**



HEINEMANN CIRCUIT BREAKER
 NO. 267. Heavy duty type 7 Amp. 24 Volt D.C. Many uses around shop. Shipping Wgt. 2 lbs. Each **\$1.00**



CUTLER HAMMER MOTOR FIELD CONTROL
 NO. 285. Rated 10 ohms. 3.2 Amps. Maximum. 6 1/2" diameter with knob and mounting feet, can be used to regulate generator output voltage. Shipping Wgt. 5 lbs. Each **\$2.50**



PENN THERMO RELAY
 NO. 268. Thermo Relay with a range of 45 to 100 complete with 5 Ft. flexible cable to immersion bulb. Shipping Wgt. 6 lbs. **\$3.50**



B & W 11 to 14 MC TANK COIL
 NO. 281. Plug in type used on BC 610 Transmitter. New, original cartons. Shipping Wgt. 2 lbs. Each **\$1.50**



DM 64A 12 VOLT DYNAMOTOR
 NO. 269. Input 12V at 5 Amps. Output 275 Volt 150 MA. New. Shipping Wgt. 7 lbs. Each **\$5.50**

DM 32A COMMAND SET DYNAMOTOR
 NO. 270. Part of 274N Command Receivers. Input 28 Volts, output 250V at 60 MA. Shipping Wgt. 4 lbs. Each **\$5.50**

DM 21 12 VOLT DYNAMOTOR
 NO. 271. Used in Army BC 312 Communication Receiver. Input 12 Volts at 3.3 Amps. Output 235 Volts at 90 MA. New, original cartons. Shipping Wgt. 8 lbs. Each **\$5.50**

PE94C SCR 522 POWER SUPPLY
 NO. 272. Complete dynamotor power supply for the SCR 522, operates from 28 Volts. Complete with controls, filters, etc. Original carton. Shipping Wgt. 34 lbs. Each **\$8.75**

PE101C BC645 POWER SUPPLY
 NO. 273. Complete power supply for BC 645. Operates from 12 or 24 Volts. Supplies both AC and DC required. Shipping Wgt. 13 lbs. Each **\$3.95**

DM 35 12 VOLT DYNAMOTOR
 NO. 274. New input 12 Volt at 18.7 Amperes. Supplies 675V at 275 MA or 1/2 above voltage from 6 volts. Excellent for auto use. Shipping Wgt. 11 lbs. Each **\$7.50**

PE 86 DYNAMOTOR
 NO. 214. A popular 28 Volt receiver dynamotor used on present military equipment. Supplies 250V at 60 MA. Shipping Wgt. 4 lbs. Each **\$5.50**

GN 58 HAND GENERATOR
 NO. 275. Makes excellent home lighting plant, operated by wind propeller, waterfall, gas engine, or hand crank. Reduction gear allows full output at slow speed; supplies 6 volts at 2.45 amp.; 425 volts at .115 amp. New. Add postage for 28 lbs. Each **\$7.95**
 Handles for GN 58 \$.50 each
 Connecting cord for GN 58 with plugs CD1086 \$1.50 each

COLLINS AUTOTUNE CONTROL HEAD
 NO. 278. Brand new controls used on the ART/13, 100 Watt, Transmitter. Types 7, 8, 10, and 11 available. Get a spare while available as new cost is over \$22.00 each. Shipping Wgt. 3 lbs. Price any type (mention when ordering). Each **\$4.50**

MC 432 VHF ANTENNA LOADING UNIT
 NO. 279. Contains 2 pole, 5 position rotary switch with silver ceramic variable condensers, and coils for matching VHF transmitter to AN109 antenna with 50 ohm line. Many useful ports. Shipping Wgt. 2 lbs. Each **\$1.50**

148 OUTDOOR TELEGRAPH KEY
 NO. 280. Rugged enclosed type for outdoor use, built for army to withstand hard usage. Complete with cord and PL55 plug. Shipping Wgt. 2 lbs. Each **\$2.00**

ONE KILOWATT ADJUSTABLE ANTENNA LOADING COIL
 NO. 282. Huge porcelain coil 4" diameter 8 1/4" long, has 5 sliders for adjustments. Shipping Wgt. 5 lbs. **\$3.50**

300 MA SELENIUM RECTIFIERS
 NO. 209. Rated 300 MA at 36 Volts, complete with mounting brackets. Shipping Wgt. 1 lb. **3 FOR \$1.00**

DUAL SELENIUM RECTIFIER
 NO. 283. Two units mounted on single bracket, each section rated 15V. at 1/2 Amp. Shipping Wgt. 1 lb. **2 FOR \$1.00**

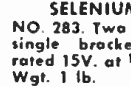

HOW TO ORDER ••• GIVE PART NUMBER AND DESCRIPTION... ADD POSTAGE FOR WEIGHT SHOWN. NO ORDERS UNDER \$2.00... WE WILL SHIP C.O.D.

Buy WHERE YOU SEE THIS BANNER ... because IT'S BETTER FOR YOU!

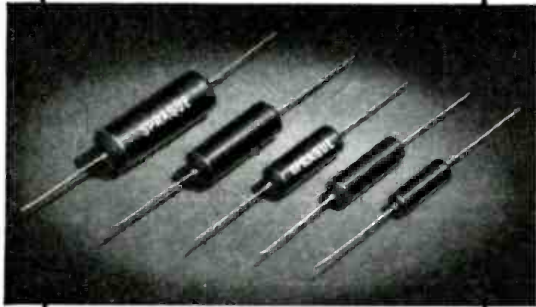

SPRAGUE TM TUBULARS
The first truly practical MOLDED Paper Tubulars! Now in stock—ready for your use—See your SPRAGUE Distributor.

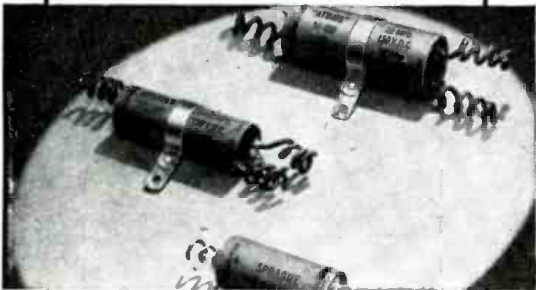

SPRAGUE ATOMS—DRY ELECTROLYTICS
You can make up virtually any required capacity-voltage combination with a small stock. Keep a representative supply in your shop. SAVE TIME—SAVE MONEY—SAVE SPACE!



SPRAGUE EL SELF-MOUNTING MIDGET CAN CAPACITORS
No other Dry Electrolytic gives so much dependability in so small a space! Tinned, Twist-Prong Tabs for easy soldering; quick, universal self-mounting. SAVES TIME—SPEEDS RELIABLE SERVICE!



Yes, its better for you *and your business* to buy where this banner is displayed because the SPRAGUE BANNER identifies a Distributor who agrees that "It's foolish to play penny-ante when your business is at stake!"

Your Sprague Distributor is a successful business man. He knows the parts business intimately—and he knows that to really build a bigger, more successful service business, you should use only the best replacement parts. That's why he features Sprague Capacitors and *Koolohm Resistors. His business depends on your success and he wants you to remember that **YOUR REPUTATION AND YOUR CUSTOMERS ARE TOO VALUABLE TO RISK FOR THE FEW PENNIES "SAVED" BY BUYING INFERIOR OR UNKNOWN "BARGAINS"!**



Yes! We're Listed in the **RED BOOK**

Looking for the correct Sprague replacement capacitors for any receiver manufactured from 1938 to 1948? It's easy—just refer to The Radio Industry RED BOOK . . .



SPRAGUE CAPACITORS *KOOLOHM RESISTORS
*T.M. Reg. U.S. Pat. Off.

MULTIPERCEPTION

Television will change our habits even more than radio . .

By HUGO GERNSBACK

PSYCHOLOGISTS are insistent in pointing out that human beings do not make the most of their brain power. Each new technical advance, every new tool, many new inventions open up entirely new avenues of human progress. We take most of these things for granted and seldom realize that we are still at the beginning of exploiting our mental powers.

Radio not only changed a number of our former habits, but also brought us numerous new accomplishments not known before the advent of broadcasting. The masses are today much better informed in almost every line of human endeavor. Our musical appreciation has taken on new meaning and risen to new heights. A wealth of information and knowledge only known to serious students before Radio, is commonplace today.

Our perception also has been greatly enhanced in a manner not even dreamt by Dr. de Forest when he first launched broadcasting at the turn of the century.

The new rising generation now already uses radio in a way that the older generation totally fails to comprehend. The younger people now listen routinely to radio practically constantly—irrespective of what they may be doing at the time. Thus, recently we noted how students of both sexes in the midst of preparation for their Regents examinations—a most difficult and harrowing experience—kept their radios going full blast while they were completely immersed in their studies. Our questioning brought out the fact that the youngsters could study and listen simultaneously—a thing the older generation has never learned to do.

Here we have to do with a phenomenon—*multiperception of the human brain*. If this were an isolated example, perhaps it might be thought unusual. But, as we look around us we see that all the younger people are doing precisely the same thing, whether they are stenographers, switchboard operators, factory hands, accountants, or working at countless other professions and endeavors.

At first we might doubt that this double perception would be sufficiently deep to be retained for all practical purposes, but we soon find that, indeed, the human being *can* listen and study or work at the same time and absorb *both*.

This, after all, is not any more difficult to understand than specialized multiperception endeavors with which we have been familiar for centuries.

We will give only a single example. An organist can and does play the organ not only with both hands, but also with both feet at the same time. On top of this he not only reads his notes, but if necessary he can also read the words of the theme and sing at the same time. This is *five-fold multiperception*: playing the organ by hand, by foot, reading the notes, reading the words, and singing. Once the organist is properly trained he finds no difficulty in doing all these functions routinely. This would seem a most complex undertaking of the human machine and, indeed, it is just that.

If a psychologist were to analyze and enumerate *everything* that happens while the organist is at work, a good-

sized book could be filled with all the processes involved.

Remember that the brain must give the impulse to everything that goes on; even such a "simple" thing as reading a note and striking exactly the right key without looking at the keyboard, would fill many pages of the book on nerve impulse-muscle coordination, etc.

It should be well understood that all new endeavors are best learned in youth. Older people find it difficult to coordinate. The youngster, for instance, has no trouble in learning to typewrite—whether sight or touch—while older people find it difficult to master it—if they ever do.

We now come to television, where a most interesting possibility of multiperception exists. Listening to the radio means only sound—with closed eyes if necessary. Or, you may have your back turned to the receiver. Not so with television.

Here you must look at the image. But present-day civilization being what it is, television is going to be a terrifically time-consuming undertaking for all of us. Are we in the future going to sit motionless before our television receivers as we do now? Certainly not. The present generation now, not even in their teens, will act differently. They will find it easy to study, read books, listen, and look at the television set simultaneously. We might think this a difficult order, but it really is not.

Television table models are already being made. Soon they will be built into tables and desks with the screen at the correct angle so when we sit at our desks and work, we will train our eyes not only to read our books or do our work, but also manage to see what is on the television screen as well.

This means coordination of a different sort than we have been accustomed to up to now. It means our eyes will have to be trained to quickly look up, then down through a small angle. This is not so impossible as it sounds. When the piano student learns to play he has to watch his hands and read the notes at the same time. All this takes time, but can be mastered to perfection within a few years. Moreover, the angle through which the eyeball has to move in piano playing is far greater than the angle from book to television screen. (If the tele-set is on the desk.)

Will the new and coming generation perceive everything on the television screen in addition to doing its work, or reading books efficiently? The answer is yes. You may not be able to view everything 100% in this manner, but if you see 80% or 90% of the action this will be sufficient to give you a good comprehension even if a fast baseball game is in progress. Will all this extra work fatigue or damage the eye? Not in the slightest. We do not work our muscles sufficiently anyway, nowadays, according to physicians.

The only strain caused by our present-day television sets is due to insufficient illumination in our cathode-ray tubes. This, however, is only a passing condition of the new art. Future television receivers will have such brilliantly lighted screens that they can be viewed in bright daylight, or at night with a strong table lamp on the same desk.

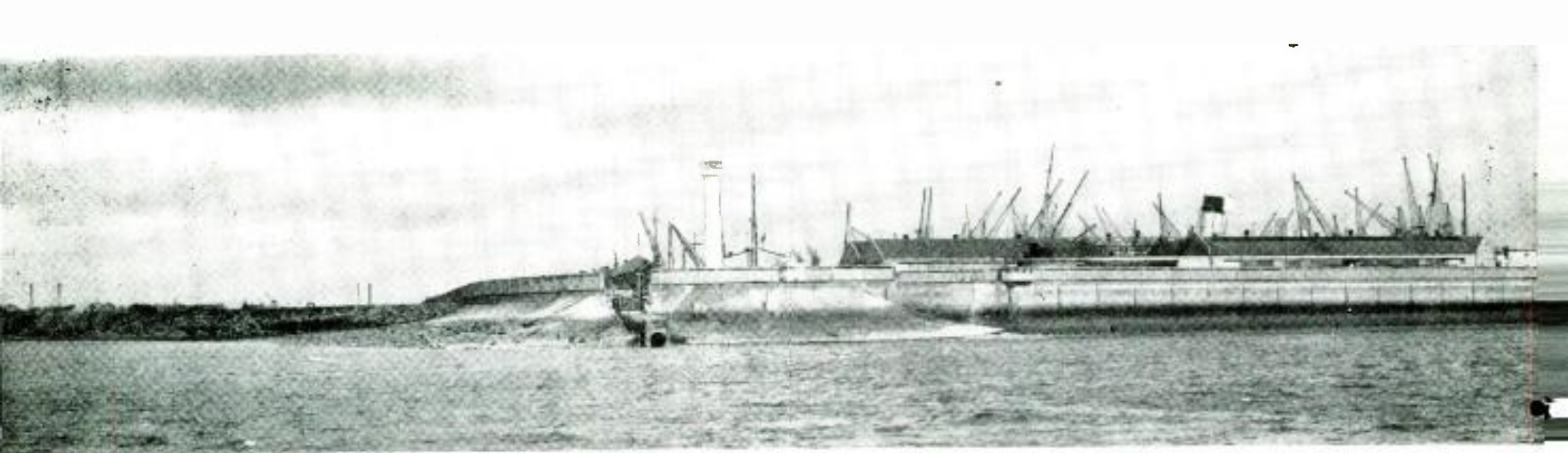

The radar installation is at the northwest corner of Gladstone Dock, a strategic position which adds to the efficiency of the equipment.

Radar Eyes Bring Safety To Fog-Bound Liverpool

By
Major RALPH W. HALLOWS

HANDLING more than 10 million tons of goods each year and serving the densely populated northwestern industrial areas, Liverpool is one of the most important of Britain's seaports. It is also one of the most difficult in the world for shipping. A glance at the map will make one of the reasons for this clear. The port lies at the head of a winding channel 12 miles in length and nowhere much more than a quarter of a mile wide. The channel divides the great sandbanks of Liverpool Bay. On that

stretch of coast, with its 30-foot tides, the sand is always on the move; in the last 60 years the annual amount of it dredged from the Mersey Channel has averaged 14 million tons. The channel is very carefully marked by three light vessels and between 50 and 60 powerful acetylene buoys (every black dot on the map shows the position of one of those buoys); in fact, its appearance on a clear night has been likened to that of the main street of a great town.

No map, though, can show the greatest of all menaces to shipping in narrow waters, *the demon fog*; and Liverpool is subject to dense and frequent fogs in the colder months of the year. In the past that fog or falling snow

might bring the business of the port to a standstill and keep it inactive for days on end.

Because of the narrowness of the channel big ships can neither turn round nor anchor in it. An average of a score of ocean-going vessels enters and leaves the port every day; and once the captain of one of them has decided either to enter the channel at the Bar light vessel or to put to sea from the Liverpool docks, there is no turning back. He must go on. On this account many vessels in the past missed one or more tides for reasons of prudence. And missing even one tide is an expensive business for a big ship; the average loss is about \$2,000.

Today Liverpool and the ships using the port no longer dread the fog menace. The first complete radar approach system in the world is in use. No matter what the weather, the whole of the channel from the Bar lightship to the Liverpool docks and for some miles upstream is seen on the radar screens as clearly as the proverbial back of one's hand. Liverpool, in a word, has installed a radar system which may well revolutionize the traffic systems of half the world's great harbors. The Liverpool port authorities emphasize that it is *not a control system*. The responsibility for deciding what his ship shall do in any circumstances must always remain with the captain. In other words, he does not and will not receive orders from the shore. But he can at any time receive by radio telephone the exact position of his own vessel, of other vessels in the channel, or of any obstruction. In combination with the information provided by his own shipborne radar, this knowledge will enable him to sail safely inward or outward in weather conditions which in the past would have meant missing one or more tides.

The radar installation is entirely of

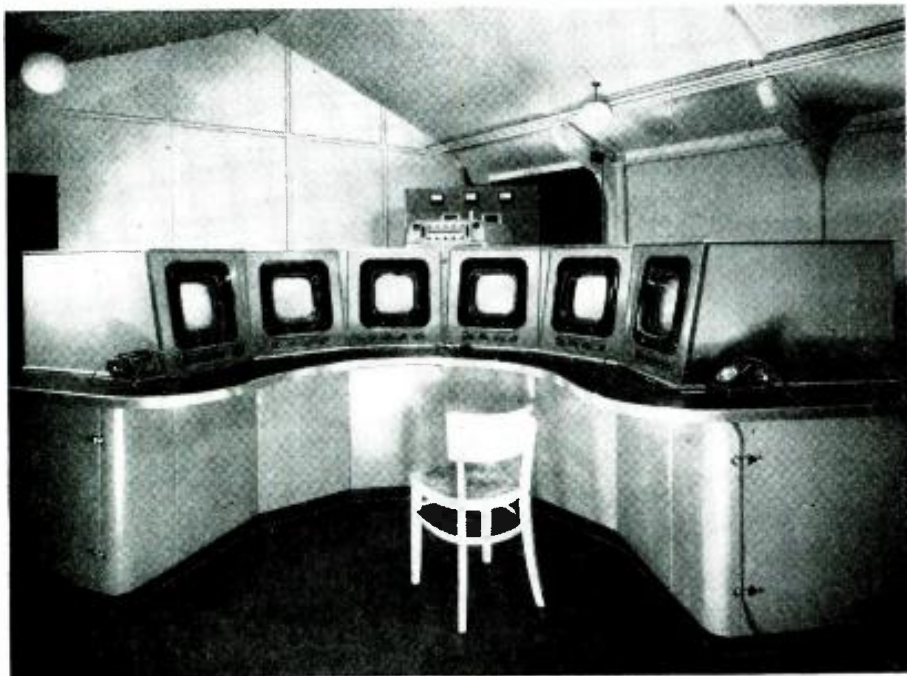

The screens show four main areas, a complete view of the channel, and a wandering display.

RADIO-ELECTRONICS for

British design. The work was carried out by the British Sperry Gyroscope Company (an associate of the American company of the same name) in conjunction with the Cossor Radio Company, both working with the collaboration of Sir Robert Watson-Watt, the originator of Britain's wartime radar chain. The screens of its presentation unit (see photo) give complete coverage of the whole channel. The normal maximum seaward range is 14 miles, but this can be increased to 22 miles when required, by the use of a switch.

These are six 15-inch presentation tubes, the "picture" occupying about 100 square inches around the central and least distorted part of each. No. 1 screen gives a small-scale view of the whole channel. The areas covered, on a scale about four times as great, by Nos. 2, 3, 4, and 5 are shown by the squares on the map. Notice that the areas have a slight overlap and in combination give a large-scale view of the entire channel. The sixth picture is in some ways the most interesting of all. It is known as the wandering display and can be moved at will to any one of 22 positions so as to give large-scale coverage of any desired part of the Mersey Estuary or of Liverpool Bay. It can thus be used to give an additional picture of any area in which there is congestion. Or, it can, if need be, replace temporarily any of the four fixed large-scale displays if necessary.

The scanner is a "cheese" antenna 15 feet in diameter by 2 feet deep, mounted at the top of an 80-foot ferro-concrete tower at the northwest corner of the Gladstone Dock. Close to the foot of the tower is a building containing the transmitter, receiver, power supply, and display unit.

The scanner itself is built of horizontal slats with gaps between them, not from a continuous sheet of metal. This is to reduce resistance to the high winds which often occur. It is heated to prevent icing in the coldest weather and rests on rollers arranged to prevent distortion of the reflecting surface by temperature changes. Driven by a 6-h.p. motor housed in a weatherproof compartment in the tower, it makes 10 revolutions per minute.

The peak pulse power of the transmitter is 30 kw, with a 0.25-microsecond pulse and a repetition frequency of 1,000 per second. The frequency band used is 9,425 to 9,525 mc (wavelength = approximately 3 cm). Special precautions have been taken in the design of the mirror to reduce side lobes. The width of the beam is 0.7 degree horizontally and 5 degrees vertically. The discrimination is better than 45 minutes in bearing and 40 yards in range.

Now for some particulars of the displays, which have already been briefly mentioned. These are an entirely new type of P.P.I. (plan position indicator), which gives true plan presentation without distortion. An interesting point is that, owing to the long afterglow, a moving ship leaves what looks like a wake on the tube; therefore, it is easy



Close-up of the rotating "cheese" antenna, built of strips to reduce wind resistance.

to see at a glance the direction in which any vessel is moving. In front of each tube is a transparency on which all light buoys and other floating sailing marks are shown in green. It is most important that the positions of these should be constantly checked and any displacement announced at once. Formerly this was a laborious business needing a large staff. Now checking is automatic, for operators can see at a glance whether or not the radar echoes coincide with the green marks on the transparency.

The transparency carries also a red lattice of grid lines. In this way the position of any ship can be plotted in the display room in a matter of seconds on a large-scale chart, which carries the same grid lines. Should a vessel require a quick "fix" of her position, this can

be read straight off the P.P.I. screen and radioed instantly to her.

At the present time the movements of all ships up and down the river and their positions from moment to moment are telephoned continuously to the administrative headquarters of the port from the radar operating room. At headquarters they are plotted on a large chart. It is intended shortly to replace this telephone communication by a television link.

An important part of the Liverpool radar scheme is the direct service from radar operating room to ship by radio telephone. This is conducted on a special frequency, and when the pilot boards any ship, he takes with him a portable pretuned transmitter-receiver.

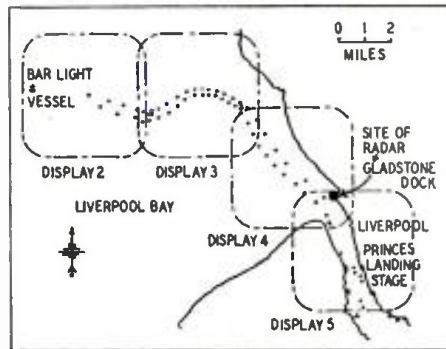

The four main areas of the Liverpool system.

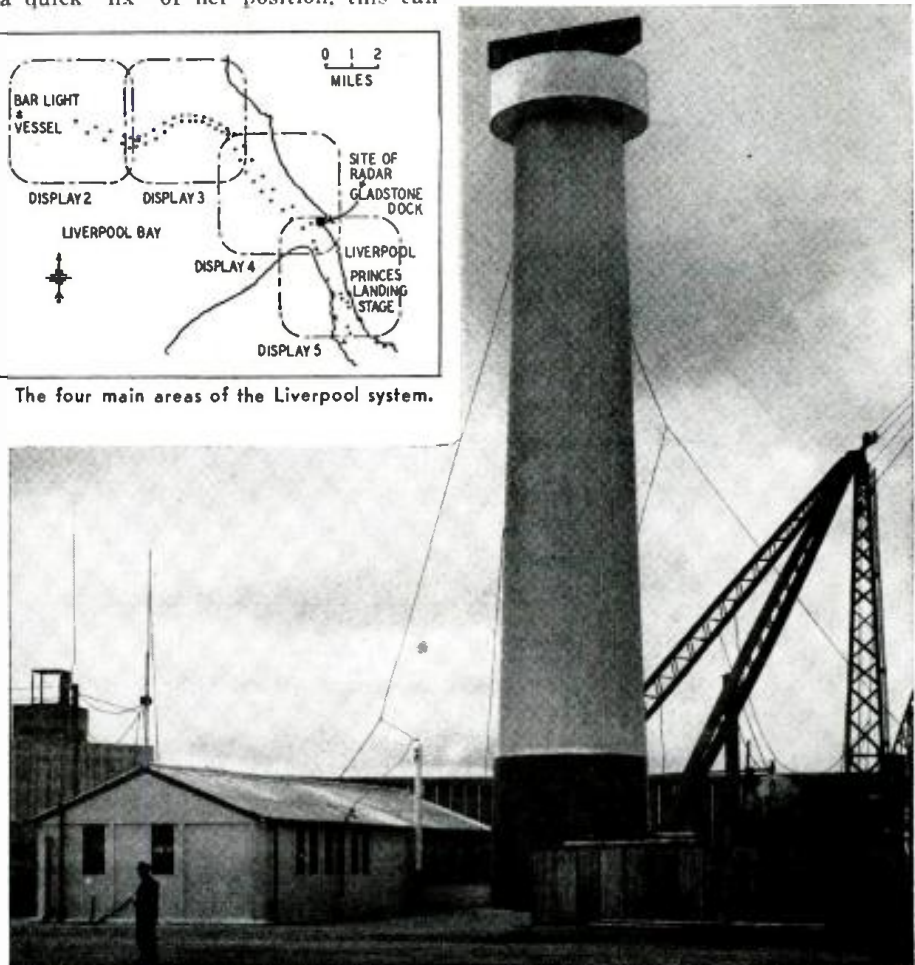

Apparatus and operating room are in the building at foot of the 80-foot concrete tower.



By VIRGINIA WALTERS*

WHY use waveguides? At microwave frequencies (frequencies above 300 mc) the inductance of a twin-lead or co-axial line becomes so high and the



Fig. 1—Waveguide section for 3950-5850 mc.

capacitance so low that such transmission lines cannot be used.

Skin effect is practically negligible at lower frequencies. The current is distributed almost uniformly through a conductor. At higher frequencies most of the current is confined to the outer surface of the conductor, and a transmission line which conducts lower frequencies well looks like a resistance to microwaves. Electromagnetic energy cannot be conducted by one of these transmission lines. Instead it must be propagated in a waveguide.

Waveguides are hollow rectangular or circular pipes (see Fig. 1). They have tremendous advantage over coaxial lines as far as high power is concerned, and can carry up to five megawatts with very low losses. This is the highest power ever obtained. Waveguides are broad-band as well. A variation of 35 to 40% in the frequency is possible without serious attenuation.

Everyone who has worked with short waves is familiar with the natural waveguide that causes skip. Sometimes reception is surprisingly good at some distance from the transmitter, sometimes it is distorted, and sometimes the signal is not received at all. Fig. 2

helps to illustrate this problem. The transmitted signal may bounce back and forth between the earth and the Heaviside layer. If a receiver happens to be at a point where a signal of a particular frequency is reflected from the Heaviside layer, reception will be good. If the Heaviside layer is higher or lower because of atmospheric conditions, time of day, or other reasons, reception may be poor at this same point for the same frequency as before, but it may be good for another frequency. Reception is affected by a relationship between the transmitted frequency and the height of the Heaviside layer.

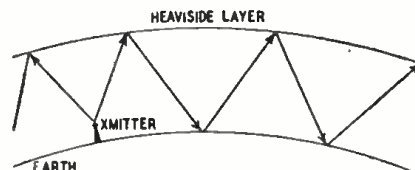

Fig. 2—An Earth-Heaviside-layer waveguide.

Actually this is simply a waveguide problem where the earth and the Heaviside layer are two walls of a waveguide. In the same way as a transmitter radiates power into the air, an antenna or metal probe introduces power into a waveguide. This electromagnetic energy bounces back and forth between the walls of the guide, but because of the particular frequency and the spacing between the walls, there is only one pattern the electromagnetic wave can take.

Figs. 3 and 4 help give a better understanding of the propagation of the wave. Fig. 3 shows the electrostatic field of a sine wave travelling in free space. A, C, and E are wavefronts. B and D are nodes or zero points. A and E are positive maxima, and C is a negative maximum. From A to E is a wavelength in free space. A to C or C to E is a half wavelength in free space. The direction of propagation is from E to A in the figure.

TABLE I

	COLUMN A CLOSED OR SHORTED LINE	COLUMN B OPEN LINE
IF THIS LINE IS LESS THAN 1/4 WAVELENGTH	IT LOOKS INDUCTIVE	IT LOOKS CAPACITIVE
IF THE LINE IS 1/4 WAVELENGTH	IT LOOKS OPEN	IT LOOKS CLOSED
IF THE LINE IS BETWEEN 1/4 AND 1/2 WAVELENGTH	IT LOOKS CAPACITIVE	IT LOOKS INDUCTIVE
IF THE LINE IS 1/2 WAVELENGTH	IT LOOKS CLOSED	IT LOOKS OPEN

The capacitive or inductive effects of different lengths of open or shorted waveguide.

*Staff Physicist, DeMornay-Budd, Inc., New York, N. Y.

A probe inserted in a waveguide will radiate waves. Fig. 4 shows what happens along two of these wavepaths. Positive maxima and negative maxima

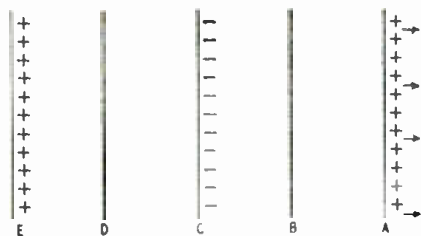

Fig. 3—An electrostatic field in free space.

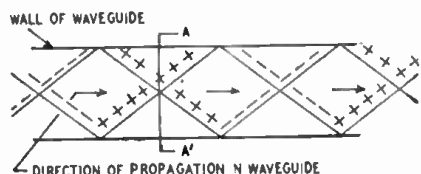

Fig. 4—How waves cancel at the walls and reinforce at the center of the waveguide.

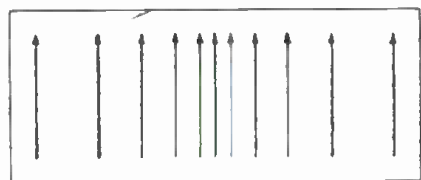

Fig. 5—Cross-section of guide, TE₀₁ mode.

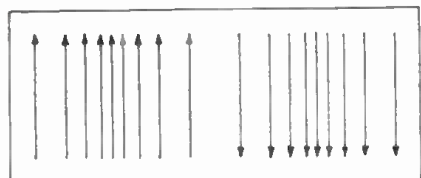

Fig. 6—An electric field of the TE₁₀ mode.



Fig. 7—Electrostatic field, guide of Fig. 5.

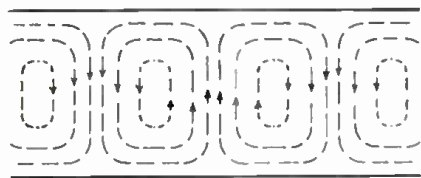

Fig. 8—Electromagnetic field of above guide.

meet alternately and add up to make a strong field at the center of the guide. The walls of the waveguide pass through points where the positive and negative maxima meet and cancel, so no electric field exists at the walls and there is no current along them. Fig. 5 shows the electric field of a cross-section of the waveguide at A-A' in Fig. 4. The field is strongest where the arrows are most closely grouped. The number of arrows goes from zero (near the left and right edges) to a maximum (at the center). This is known as a half-wave pattern. (Fig. 6 illustrates a full-wave pattern.)

The pattern of the wave described above is known as the TE₀₁ mode. This wave, like all electromagnetic waves,

has electric and magnetic components. In this case TE means transverse electric because the electric field is across the guide or transverse to the direction of propagation. See Fig. 7, which is a side view of the waveguide of Fig. 5. The top view, Fig. 8, shows the magnetic field components.

In a *transverse magnetic* (TM) mode, the magnetic instead of the electric field is across the guide, with no part of a magnetic field line running along the guide, as it does in the TE mode illustrated in Fig. 8.

The subscripts 0 and 1 signify the number of half-wave patterns of the electric field along the two sides of the guide. The subscript 0 refers to the short side in Fig. 5 and the subscript 1 refers to the long side.

The size of a waveguide determines the lowest frequency it can carry. Above this frequency, known as *cutoff*, radiation may be propagated down the guide. When the frequency used is too high, there are other modes than the TE₀₁ which may be propagated. The wavelengths are shorter so there may be more half-wave patterns across the guide. These higher modes are known as TE₁₀, TM₁₀, etc. Higher modes complicate transmission problems, so it is common practice to operate a waveguide at frequencies where only the TE₀₁ and no other modes can exist.

Microwave radio parts

Conventional resistors, condensers, and inductances cannot be used for microwaves, because their sizes are very nearly equal to the lengths of waves at frequencies above 300 megacycles. In place of the conventional parts, special microwave components are used. These give the same effects as resistors, capacitors, and inductances. Inductance or capacitance may be introduced by using guides of varying length. Table I is based on transmission line theory and shows the effects of the length of line when the line is closed or shorted (column A) or open (column B).

Instead of a resistor, a waveguide *attenuator* is used. It is constructed to absorb power and is used to cut down power in the line or to terminate the line. Fig. 9 shows a variable attenuator. It is usually a strip of dielectric material coated with a power-absorbing material, such as carbon. The strip is mounted in the section of waveguide and may be moved in and out through the slot in the guide. The strip has no effect when it is out of the guide, and reduces the power as it is moved into the guide.

Although capacitive and inductive effects appear at certain distances from the end of a shorted or open line as in Table I, it is not always convenient to terminate the line. Then capacitance or inductance must be introduced somewhere along the guide instead. *Windows*, as illustrated in Figs. 10 and 11, are used for this purpose. A window consists of two thin metal plates extending from opposite sides of the wave-

guide toward the center. The inductive or capacitive reactance increases with the depth of the metal plates.

Microwave measurements

In microwave apparatus, it is important to know if the power is being propagated without losses. If there are losses, it is necessary to locate and measure them, so that they may be reduced. With the waveguide components so far described as a basis, many others have been designed for the most direct and obvious measurements of r.f. energy. The impedance of a waveguide is determined by its dimensions. For maximum power transfer, an impedance match is required. Impedance mismatch may be caused by discontinuities in the transmission line. Examples are: junction of two sections of waveguide where misalignment may occur, change of direction of propagation, variation of the internal dimensions. Such discontinuities partly or completely reflect the waves propagating forward, and set up another set of waves propagating back-



Fig. 9—Variable attenuator, 5850-8200 mc.

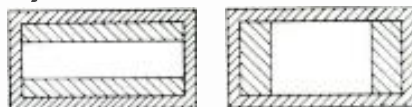

Figs. 10 and 11—Cross-section view of waveguides with capacitive and inductive windows.



Fig. 12—A tuned load for 8200-12400 mc.

ward. This is the effect you find if you attach one end of a rope to a wall and shake the other end. Waves travel to the wall, are reflected there, and start back again. If you shake the free end with the right timing, the waves going forward meet the waves coming backward so that they appear to stand still. These *standing waves* occur when waves propagating down a waveguide meet a discontinuity.

The mismatch may be measured in terms of the *voltage standing wave ratio*. This ratio is defined as the maximum voltage reading divided by the minimum voltage reading. The maximum voltage reading occurs at the crest of a standing wave and the minimum

voltage reading occurs at the lowest point. If there is no reflection, the maximum and minimum readings will be the same, and the voltage standing



Fig. 13—Cavity wavemeter for 8400-9800 mc.

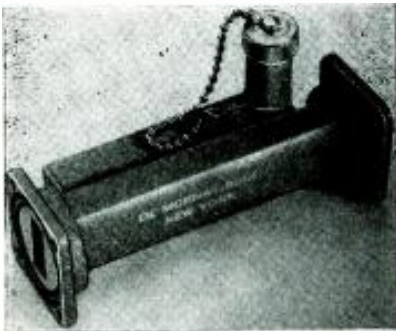

Fig. 14—Directional coupler, 8200-12400 mc.

wave ratio will be one. In this case there are no standing waves and so there are no stationary maxima and minima. (The maxima and minima of Figs. 3 and 4 are moving steadily down the guide.) If there is total reflection the ratio will be infinite because the minimum reading will be zero. Under normal conditions the standing wave ratio will be somewhere between one and infinity.

The standing wave ratio is measured with a *standing wave detector*. This instrument is made by slotting the top of a waveguide and inserting a probe which is supported by a movable carriage. The probe picks up the radiation, which is then fed through a detecting device such as a crystal and into an amplifier to a meter, which may be calibrated directly in standing wave ratio. The probe is first moved to a voltage maximum, and the meter is set to full scale. The probe is then moved to a voltage minimum, and reading on the meter then shows the standing wave ratio.

It is necessary to find the standing wave ratio to determine the amount of mismatch of a component which is to be included in a microwave device. A component to be measured is inserted in the transmission line, which *must be terminated by a perfectly matched impedance*, so that any reflections are due to the component alone and not to the termination. This requires some type of termination which must be adjustable to meet the requirements of different test set-ups. In general a *tuned load* is used (Fig. 12). A tuned load consists

of (a) a probe whose depth of insertion and whose position along the length of the guide may be controlled and (b) an absorbing strip. The probe has a capacitive effect which increases with the depth of insertion. If the probe is moved a quarter wavelength along the guide, an inductive effect will appear where before there was a capacitive effect. At intermediate positions of the probe, it will look as if there were more or less inductance or capacitance at the original position. In this way, any amount of reactance due to the reflections set up by the connecting flanges and the absorbing strip may be matched out. The ideal absorbing strip is pure resistance and absorbs all the power. But some reflections are caused by the edge of the strip in spite of the fact that it is usually tapered to minimize the surface area presented to the oncoming waves.

For each different frequency at which a test is to be made, the load must be tuned. The load is connected directly to the standing wave detector. The two tuning controls are varied until the standing wave ratio is one; this means the line is perfectly matched. The waveguide component to be tested is then inserted between the standing wave detector and the tuned termination. The standing wave ratio under these con-

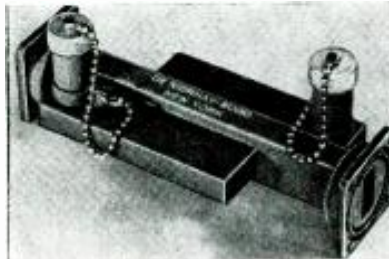

Fig. 15—Example of a bidirectional coupler.

ditions is due only to the component under test and not to the termination.

The cover picture

The test set-up pictured on the cover is arranged for just such measurements. Three tubes are used, one operating at each frequency at which a measurement is desired. These are fed into the main line through a triple input guide. A switch enables the technician to select one tube at a time, eliminating the delay of changing the frequency by adjusting a single tube.

In such a test set-up, frequency is measured by a *wavemeter* (Fig. 13). If a waveguide is completely closed except for a small hole for the power to enter, it is known as a *cavity*. A cavity resonates at a particular frequency dependent upon the dimensions of the cavity. In general a wavemeter is a cylindrical cavity which has an end plate that can be moved to vary the height of the cylinder. This wavemeter is inserted in parallel with the line so that when it is in resonance it draws power from the line and reduces the output reading. When the point of reduced output power is reached, the position of the end plate may be read on

the micrometer and the frequency determined from a calibration chart based on the size of the cavity.

A few waveguide components used in measurements have no analogous low-frequency component. For example, a *directional coupler* (Fig. 14) can tap off power for measurement from the waveguide system without affecting the line. A probe or a loop would cause some reflections and set up standing waves of its own. A directional coupler has the advantages of being broad-band, of not setting up standing waves, and of measuring only the wave going forward and not any reflections. One can see that the coupler is really two sections of waveguide side by side. In the wall between them are holes spaced so that energy coupled through them will add up for a forward-going wave. An attenuator strip or *pad* is placed in the coupler to absorb reflected waves, so that only the forward-going wave is propagated.

Developed from the directional coupler is the *bidirectional coupler* (Fig. 15), which will pick up the waves going in either direction, each independently of the other. A directional coupler always picks up a certain proportion of the power in the main guide. The power received in the coupler is a certain number of decibels down from the power in the main line—usually about 25.

Sometimes it is necessary to change the polarization of the wave to meet the mechanical requirements of microwave apparatus. Polarization is changed by a twisted section of waveguide (Fig. 16). The outgoing wave is at right angles to the incoming one, and the electric field anywhere along the twist is as shown in the cross-sectional illustration of Fig. 5.

The connecting flanges in many of the illustrations here are grooved. The outer groove may be used for a gasket to make tight fits. The inner groove is

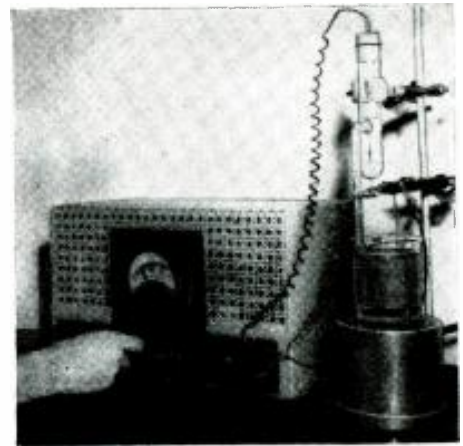

Fig. 16—This section changes polarization. precision-cut so as to absorb any leakage power and cause a minimum of reflection at the junction.

These examples of components show the simplicity of waveguides for transmission and measurement of microwaves. All a.c. effects commonly developed with transformers, resistors, condensers, inductances, and insulators at lower frequencies may be developed by waveguide components at frequencies up to 30,000 megacycles. This will be described in a series of articles in succeeding issues.

New A.F. Power Supply

By S. R. WINTERS



The regulated supply in use for electrolysis.

A NEW power supply for use in electrolysis has been developed by the National Bureau of Standards. It has the proverbial constancy of Caesar's wife in that the apparatus, functioning from a 117-volt a.c. line, affords stable and yet continuously adjustable d.c. voltages at currents up to 2 amperes or even more.

The new electronic power source bypasses faults of previous instruments. The voltage is governed by a precisely engineered, compact electronic circuit that utilizes standard radio parts. The new apparatus can produce a controlled output of several volts in loads as low as a single ohm, and identical techniques can be employed in equipment built for higher outputs. In numerous applications, the usual series-regulated power supply is handicapped because of the high load currents which must be handled directly by vacuum tubes.

In the separation of metals by electrolysis—a function served by this novel instrument—it is necessary to govern the power supplied to a load, the plating electrode, with respect to the potential of a reference electrode. An excessively high potential spells an excessive load power. Thus the function of the Bureau of Standards' electronic circuit is to curtail its output automatically until the control potential reaches the required value.

Inside the device are an amplitude-controlled oscillator (V1 and V2 in the diagram), a power amplifier (V3 and V4), and rectifier (V5), and two direct-coupled stages of amplification (V6 and V9). The oscillator, a multi-vibrator, functions at about 2,000 cycles, turning out a variable-amplitude square wave. This is amplified by a couple of audio beam-power tubes in push-pull. These tubes are linked through a step-down transformer T2 to the low-voltage, high-current selenium rectifier. An L-C filter cuts ripple and noise to a negligibly low value. The filtered voltage is the output of the instrument.

For regulation a portion of the output voltage is compared to another output voltage stabilized by a gaseous regulator tube V8. The difference between the two is amplified by the two direct-coupled stages and is employed to govern the amplitude of the signal from the oscillator.

The circuit connections are made in such a manner that the amplitude of the oscillator is increased when the output voltage drops below the reference voltage. The two stages of amplification insure exact regulation of the power supply and its output deviates very little from the reference voltage.

The reference voltage is adjustable by a knob on the panel of the instrument. This control, acting as the output voltage regulator, has a range of adjustment from 0 to 2 volts. Higher voltages may be obtained by employing only a portion of the output for comparison. If the proper voltage divider is added, the power supply can deliver as much as 8 volts.

In consequence of such a high degree of regulation, the new instrument has a low effective internal impedance. This is about .005 ohm when the entire output voltage is employed for comparison with the reference voltage. Thus, the voltage drop due to heavy load currents is small. The low internal impedance of the device suggests its adaptability as a substitute for a storage battery where constancy of output under varying loads is required. The regulation ratio is about 0.5%. To duplicate the performance of this apparatus with a

storage battery at an output of 1 volt, it would be necessary to use a voltage divider with 200-ampere fixed drain.

The regulated voltage supply may also be connected as a constant current source, if desired. The voltage drop caused by passage of the load current through a selected fixed resistance becomes the index which is compared to the reference potential. When applied in this manner, the device affords about the same advantages as when employed as a constant voltage source.

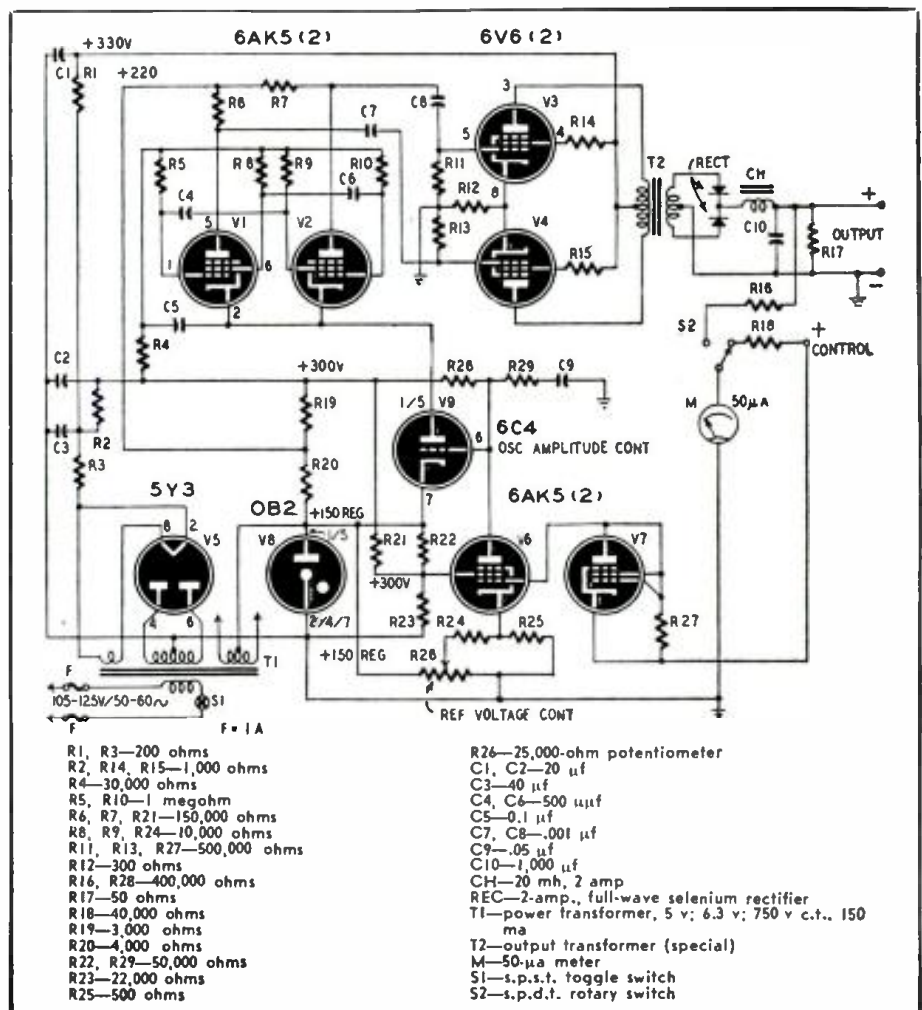

Electronics in Medicine

Part IV — Apparatus and methods for the detection and measurement of the brain's electrical activity

By **EUGENE THOMPSON**

ELECTROENCEPHALOGRAPHY is an electronic method for recording the brain's electrical activity. This activity consists of trains of brain waves called action potentials. Their frequency and amplitude depend upon the age, health, activity, emotional state, and other characteristics of the patient. Children's waves tend to be faster than adults', and extremely rapid, sharply peaked potentials are characteristic of epileptics. Movement of an arm or leg, hearing a loud noise, or even opening or closing the eyes will affect the action potentials. Strong emotions such as rage or fear may produce very interesting patterns. For these reasons, electroencephalograms are recorded with the subject reclining in a quiet, semi-

darkened room, eyes closed. Under these standard conditions, the brain of a normal adult emits an approximately sinusoidal signal which varies continuously in frequency from 1 to 100 cycles and in amplitude from 1 to 100 microvolts. However, the predominant components have a frequency of about 10 cycles and an amplitude of 10 to 50 microvolts. In most cases, the frequency and amplitude vary oppositely.

Although a great deal is known about the appearance of brain waves in health and disease no one knows how or where they arise, or what their purpose is. It is interesting to note, however, that they are not unlike FM signals. Some experts regard this as evidence that they are nerve impulses and are frequency-modulated to prevent in-

terference from other electrical discharges within the body.

The photographs and diagram show a rack-mounted electroencephalograph. It is essentially a four-stage, push-pull, resistance-capacitance-coupled amplifier. Except for slight circuit variations made by individual manufacturers, the design shown is the basic pattern around which all these devices are constructed.

The three stages of voltage amplification have a gain of over 2,000,000 (about 126 db). This is more than enough to detect and amplify signals in the microvolt range. Triodes are employed in the first stage to keep tube noise at a minimum. The relatively slight loss of gain is counteracted by the two pentode stages which follow. Some manufacturers use nonmicrophonic pentodes in the first stage instead of triodes. Noises from x-ray or diathermy equipment or from similar sources are reduced by placing the patient in a screened room, by shielding pickup cables, and by the bucking action of the push-pull circuit. All three stages are decoupled to prevent the effects of coupling through the common impedance of the power supply. Push-pull 6L6's are used in the output stage to provide sufficient power to overcome the inertia of the mechanical recording device, thus insuring faithful reproduction of the higher-frequency complexes.

The coupling condensers are larger than those employed in conventional amplifiers to assure good low-frequency response. The lowering of the high-frequency limit is not a problem because frequencies higher than 150 or 200 cycles are of no significance in electroencephalograms. No bypass condensers are needed because of the push-pull design, which bucks out the unwanted a.c. components because they are 180° out of phase. If it were not for this action of the push-pull circuit, screen bypass condensers with a capacitance of several thousand microfarads would have to be used to maintain the low-frequency response.

The instrument incorporates an elec-

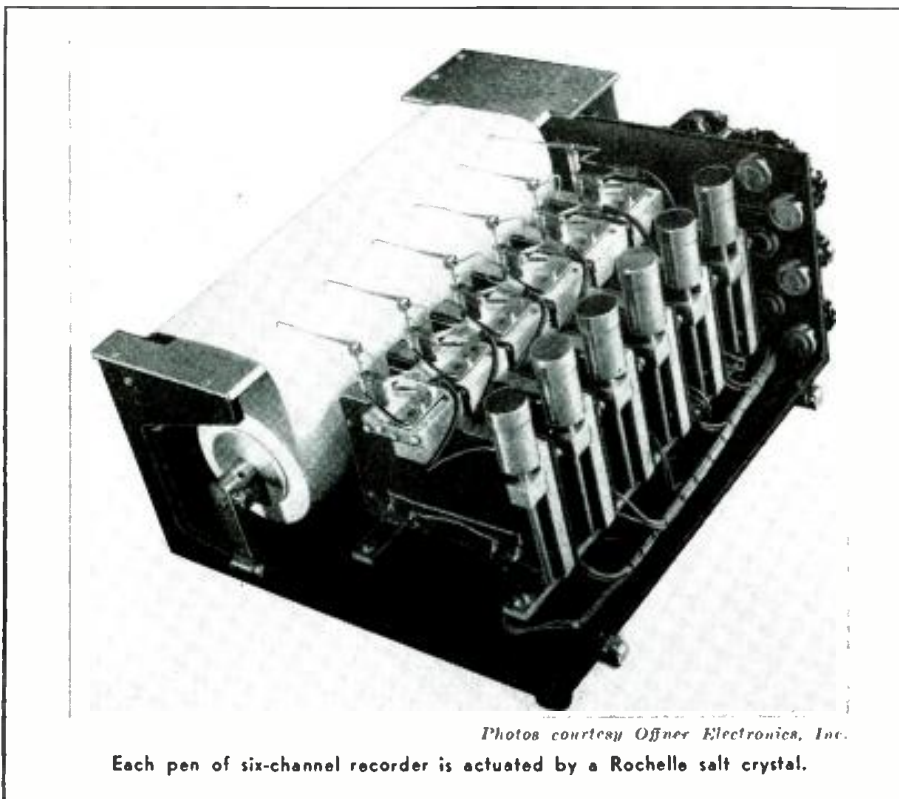

Photos courtesy Offner Electronics, Inc.

Each pen of six-channel recorder is actuated by a Rochelle salt crystal.

tronically regulated power supply because even slight variations in plate voltage would distort the low-level signals. The supply can maintain the plate and screen voltages to within a fraction of 1%.

To permit accurate measurement of the voltages picked up from the patient despite slight changes in the gain of the amplifier, a calibrating circuit consisting of a 1.5-volt dry cell and a series of calibrating resistors is employed. This circuit is shown at the input of the 6SF5 grid. By proper selection of resistors, a standard calibrating signal of 1, 10, 50, 100, or 1000 microvolts may be introduced into the amplifier while the record is being made.

Because of the cost and difficulties in processing long photographic records, they have been replaced in modern equipment by plain paper or plastic-coated-paper tape. Electrically driven pens or heated styli are used to record on these surfaces. The pen is fastened to a moving coil, similar to the voice coil in a loudspeaker. This coil is fed by the output of the 6L6's. Either an electromagnet or a permanent magnet may be used as the field supply.

A recording device which operates on a more novel principle is illustrated in the photograph. This instrument works like a crystal cutting head. The amplified brain waves are applied to a Rochelle salt crystal. The crystal is distorted in step with the variations in the applied voltage and the resulting movement is mechanically magnified by levers which actuate the pen. The pen reproduces the wave form of the brain's action potentials. In the photo there are six recorders, each of which is driven by a separate amplifier.

The brain's potentials are picked up from the surface of the scalp with small metal electrodes. These are dipped in salt paste to reduce the skin resistance, and held in place with a drop of collodion. From the electrodes, small flexible wire leads pass through a shielded cable to the input of the amplifier.

Two wires are needed to pick up the brain waves. Each pair is referred to as a lead. There are two types of leads, unipolar and bipolar. In the former type, one wire is located over some part of the brain, and the other is attached to some neutral point on the body, such as an ear lobe. In bipolar leads the second wire is placed over some area of the brain rather than on a neutral point. In general, bipolar leads give more information than unipolar ones.

The various leads are named according to the lobe of the brain over which they are placed and whose action potentials they record. Thus in the unipolar leads, there are right and left temporal, frontal, and occipital leads, etc. The bipolar leads are called bifrontal, bi-temporal, and so on. The positioning of the various electrodes requires a highly specialized knowledge of the topographical anatomy of the brain.

The combination of a lead, its amplifier, and a recording pen is referred to

as a channel. A minimum of four bipolar or six unipolar channels is required. Most clinical units have eight channels.

Electroencephalographic diagnosis is largely based on experiment although some attempts have been made to reduce parts of the technique to a mathematical basis. At present, however, there is no substitute for the experience of a trained electroencephalographer. Most diagnoses are established by inspection of the record for an abnormal preponderance of fast or slow wave forms compared to the normal, or for phase reversals between the signals picked up from different points on the surface of the head.

Electroencephalography has been used with great success in the diagnosis and localization of brain tumors, for the diagnosis of various forms of epilepsy, and for following the progress of patients being treated for these conditions. Thus far there has been no correlation between various types of psychoses, neuroses, and the intelligence quotient of the patient, and the pattern of his brain waves. Thus, idiots and college professors may have very similar



Six amplifiers are mounted in rack at right.

electroencephalograms—no reflection intended upon the gray matter of the professors! It must be added, however, that electroencephalography is still a young science, and that intensive investigations are continually being conducted which may lead to new uses.

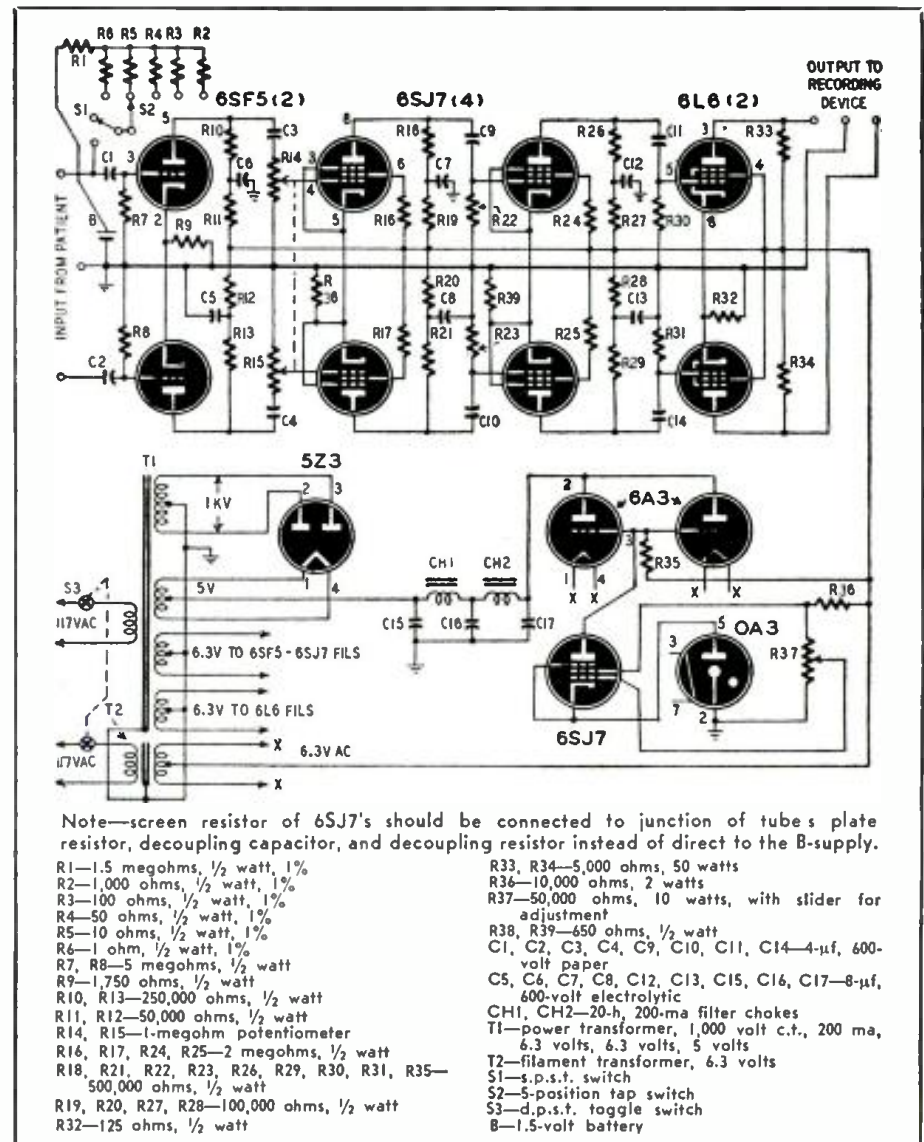



FM

Telemetering Transmitters

By LEON HILLMAN*

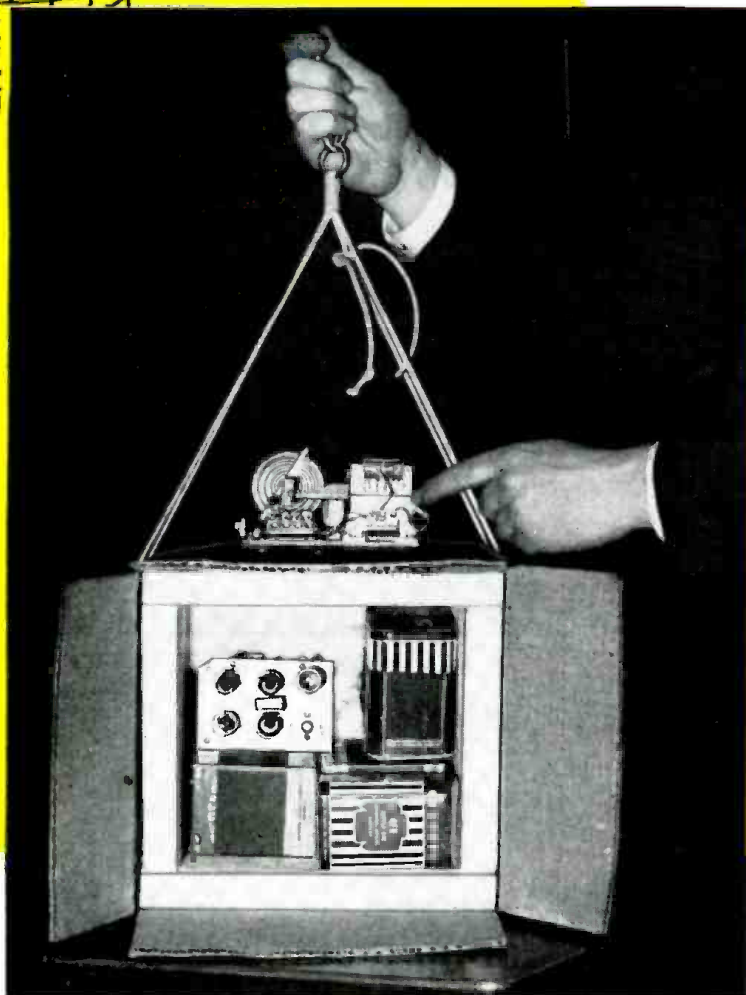

Transmitter ready for flight. Atop box is a registering aneroid barometer.

THROUGH balloon telemetering research meteorologists and physicists are gaining new tools with which to probe the mysteries of the upper atmosphere. As always, the electronic engineer is playing an important role in the steady progress of science.

Two new small transmitters for radio telemetering have been developed at New York University for weather balloon use. The transmitters include modulation circuits, one for FM and the other for AM. Their unique, simplified modulation circuits and their compact design make these transmitters useful for voice communication, radio remote control, as well as telemetering systems.

Of particular interest is the new FM transmitter circuit shown in Fig. 1. Frequency modulation offers considerable advantage in signal-to-noise ratio for line-of-sight transmission at the higher frequencies.

Several transmitters were constructed, at first using the conventional reactance tube to obtain FM. Only a small amount of deviation can be achieved by this method and doublers must be used to obtain a 150-kc swing.

The new circuit does not require frequency multipliers, since the required

deviation may be obtained at the fundamental frequency. To do this a vacuum tube (V2-a in Fig. 1) is used as a variable resistance in series with the cathode of the oscillator V1.

The frequency of a self-excited oscillator depends to some extent on the plate voltage. Impressing an audio signal on the grid of V2-a varies the resistance of its plate circuit, increasing the plate current when the grid is positive and decreasing it when the grid is negative. Since the voltage drop across the tube is proportional to the current flowing through it, the tube acts as a variable resistance.

These changes in voltage across the modulator vary the oscillator plate voltage at an audio rate. The plate voltage changes on the oscillator vary the oscillator frequency. To stabilize the oscillator against changes in frequency due to variations in battery voltage, a neon-bulb voltage regulator is used. Thus, only changes in the modulation signal produce a carrier swing.

The output of the oscillator is capacitance-coupled to a class-C r.f. amplifier V2-b, which acts also as an r.f. limiter. To obtain a wide tuning range, the resonant circuits of both the oscillator and the amplifier are composed of

a combination of slug-tuned coils and variable mica trimmers. The slug-tuned coils are adjustable from the outside and are used for fine tuning.

The transmitter operates on any plate voltage between 180 and 270. This wide range is desirable because the batteries may have to be used for a long period of time though they depreciate due to current drain and low temperatures in the upper atmosphere.

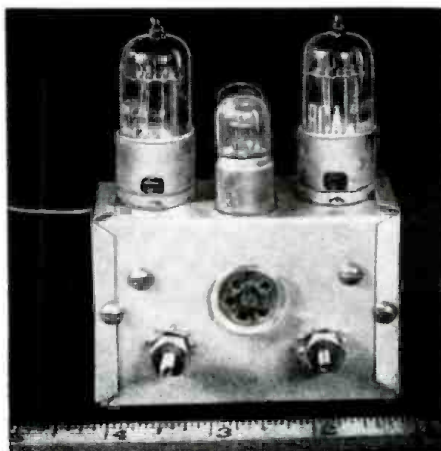

Power is supplied through the 5-prong socket. Antenna and control leads come through side.

* New York University College of Engineering

The tuning range is from 20 to 100 mc. Power output is approximately 1 watt. The transmitter uses two 3A5's. These are dual triodes and therefore are equivalent to four separate tubes. One section is used for the modulator, a second for the oscillator, and a third for the r.f. amplifier. The extra triode is unused.

The amplifier and oscillator coils are wound on 1/2-inch forms with adjustable powdered-iron cores. Both coils consist of 5 turns of No. 14 enamel wire tapped at the center. The turns are spaced the diameter of the wire. The antenna coupling coil consists of 2 turns of plastic-covered wire around the center of the amplifier plate coil.

A blocking oscillator (Fig. 2) converts meteorological data into an audio signal which may be transmitted. The blocking oscillator is, in effect, a feedback oscillator which quenches itself periodically due to the time constant of R1-C1. By varying R1 the audio frequency may be set between 10 and 500 cycles.

The blocking oscillator operates on approximately 1 megacycle. The plate coil is tuned by TC which is the sum of the distributed capacitance of the wiring and the interelectrode capacitance of the tube. The coil is wound with 10/40 litz wire on a 1/4-inch form. The plate coil has 100 turns wound in a pie 1/8 inch wide. The grid coil, L, (Fig. 2) consists of 75 turns in a pie similar to the plate winding. The windings are spaced 1/8 inch apart.

The audio frequency may be used for operating frequency-sensitive relays in a control receiver. To show how the blocking oscillator is used for temperature measurement, consider what happens when a high resistance with a large temperature coefficient is exposed to the atmosphere. The resistor replaces R1 in Fig. 2. Since its resistance varies in proportion to the temperature, the blocking oscillator produces an audio frequency which is dependent on the temperature. Using a chart showing frequency as a function of resistance and temperature, the ground operator compares the received audio frequency with the values on the chart to determine the atmospheric temperature.

The antenna is important, since signals must be transmitted for long distances. A conventional half-wave vertical dipole is best for the purpose. For receiving, a vertical dipole is used in most cases, although some experiments with an omnidirectional circularly polarized antenna have been successful. Sometimes it is necessary to locate the position of the balloon in flight. In such cases a highly directional antenna with 32 elements in a broadside array and a receiver provided with lobe scanning and an oscillograph for observation are used.

The transmitter is built on a U-shaped frame and is completely shielded with an aluminum cover. The r.f. amplifier is shielded from the oscillator with a thin aluminum parti-

tion which does not extend completely across the chassis but separates the r.f. coils and leaves room for the coupling condenser and filament- and plate-supply leads. A small five-prong plug is used for connecting the battery supply. The antenna and signal leads are brought out through grommets holes in the aluminum cover. To eliminate weight and extra components the neon bulbs are not mounted in sockets. Instead, they are force-fitted into a slightly undersize hole in the aluminum chassis. Since the underside of the chassis, containing all of the wiring and most of the circuit components, measures only 3 x 2 inches, the transmitter is built in planned stages. After the tube sockets and power plug are mounted, the tube filament leads and the plate power leads are wired in. The r.f. coils are mounted next and connected. These are followed by the r.f. chokes, tuning trimmers, and the remaining components.

Adjustments

The transmitter is tuned with the cover removed by adjusting the oscil-

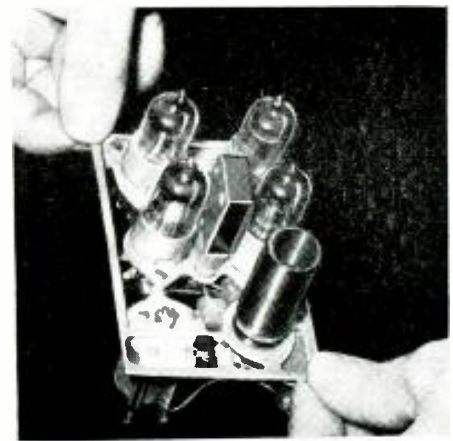

The AM transmitter. Metal sections are removed from the chassis to reduce weight.

lator trimmer until the desired frequency is reached. The amplifier trimmer is adjusted next with the antenna disconnected, until the amplifier plate current drops to a minimum. The cover is then replaced and the tuning repeated by adjusting the cores of the r.f. coils. A 10-mc tuning range can be

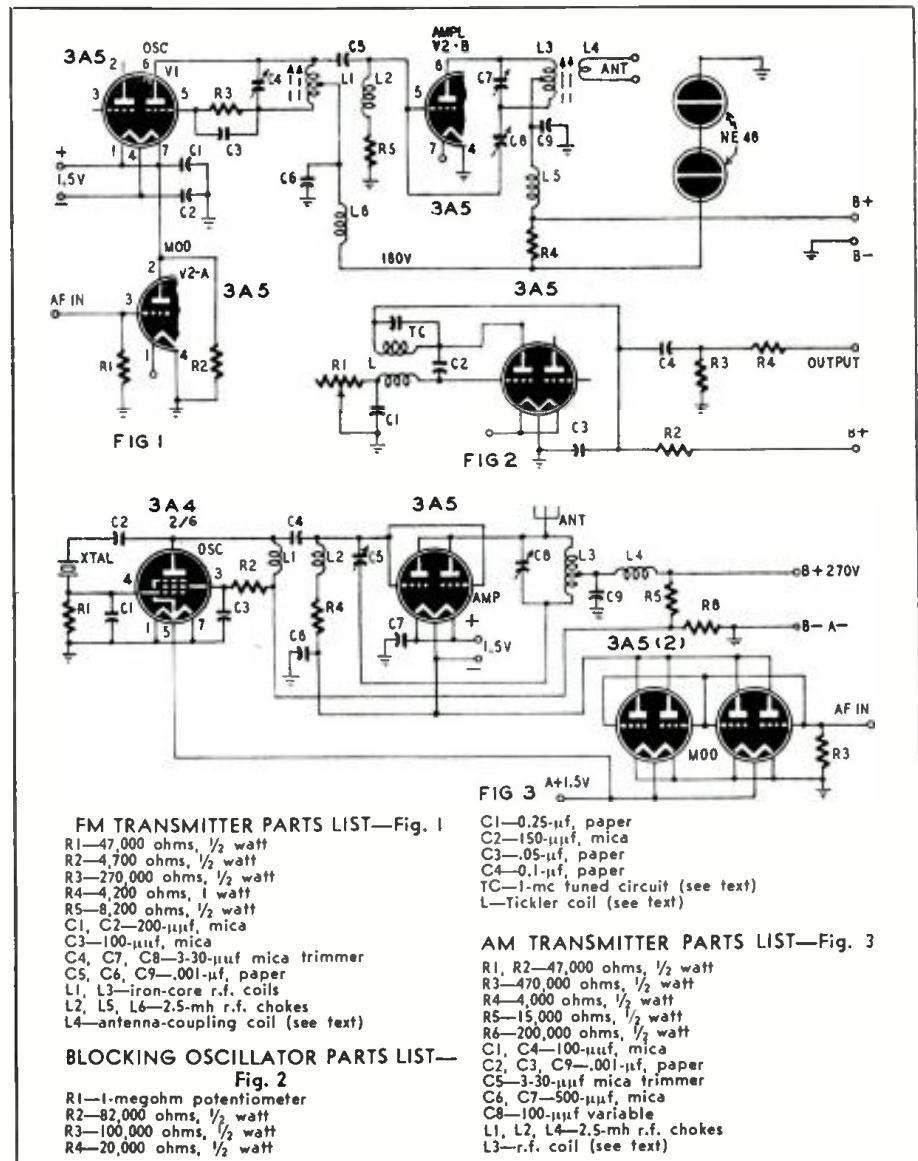

covered with the slug-tuned coils. For greater variations, the cover is removed and the trimmers are readjusted.

In preparation for a balloon flight, the transmitter is placed inside a corrugated carton lined with 1 inch of Styrofoam insulation to minimize the effects of the outside temperature. The battery pack consists of as many 67½-volt batteries, connected in series-parallel, as are required for the flight duration. Several 1½-volt batteries are included in the pack for filament supply.

Other circuit designs

In addition to the FM transmitter, several other circuits have been tested and flown. For transmission ranges exceeding the line of sight, it was necessary to employ frequencies below 20 mc. An AM transmitter with a power output of 2 watts was developed. To obtain modulation with a minimum of components an unconventional circuit was used. This is shown in Fig. 3. Three paralleled 3A5 sections are used as a series resistance, as in the FM transmitter. With AM, however, the tubes are in series with the plate-voltage supply of the r.f. amplifier. Fig. 3 erroneously shows four sections of the 3A5's in parallel. In practice, only three sections are used. The remaining triode section can be used as the blocking oscillator if one is used.

The AM transmitter is crystal-controlled, using a Pierce oscillator. The three 3A5 sections provide a high percentage of modulation. Plug-in coils are used in the r.f. amplifier. The circuit is tuned with a variable air condenser. The amplifier may be used as a doubler by tuning the tank circuit to twice the oscillator frequency. It is neutralized with a small mica trimmer condenser C5. The tube is neutralized with the B-plus lead disconnected from the amp-

lifier. A pickup coil connected directly to the plates of a cathode-ray oscilloscope is used as a detector of r.f. The neutralizing condenser is rotated until no r.f. envelope is seen on the scope screen for any position of the tank condenser.

To measure the power output of the transmitter, a three-turn loop is wound around the tank coil and connected in series with a coil, variable condenser, r.f. milliammeter, and a 22-ohm noninductive load resistance. With the inductance and capacitance tuned to series resonance, the power output is calculated from Ohm's law, where P equals I^2R . With the transmitter as shown, the r.f. current is about 300 ma, corresponding to a power output of 2 watts. With the plate voltage set at 270, the transmitter will draw approximately 20 ma at no load. With the dummy load applied the plate current rises to about 35 ma.

If a half-wave or other resistive antenna is coupled to the transmitter, the plate current will also read 35 ma. A half-wave antenna connected directly to the plate of the amplifier tube is most satisfactory. The transmitter will operate on any B-voltage between 150 and 300. Two separate 1½-volt filament supplies are required. The four tubes and tank coil are mounted on top of an aluminum plate measuring 3 x 4 inches. Total weight of the transmitter without batteries is 8½ ounces.

The AM design has been tested thoroughly—on many occasions it has transmitted signals from the upper atmosphere for over 9 hours and for a distance of 400 miles.

These transmitters have been useful to meteorologists for making upper-air measurements and for obtaining information on the movement of an air mass. Attached to meteorological bal-

loons which move with the air currents, the miniature radio transmitter relays vital data to a ground receiving station.

Not standard radiosondes

The equipment differs from the standard radiosonde in the long period over which it is required to operate and the longer distance from which reception is required. The standard radiosonde transmitter is sent aloft and the balloon continues to rise until it reaches approximately 60,000 feet. Then the balloon bursts and the equipment descends to earth on a parachute. The total time for ascension takes about an hour. With the new balloons and control equipment the flight lasts many hours, frequently eight or nine, and the transmitter provides required data continuously.

To achieve a range of several hundred miles, it has been found necessary to use transmitters with a power output of at least four times that of the standard radiosonde, which is usually only 250 mw. The transmitters developed at New York University College of Engineering are unique for their compactness, low weight, high efficiency, and novel circuit arrangement. Though designed basically for balloon telemetering, they can be applied to other services where lightweight, low-drain transmitters are required. They may be used for amateur or point-to-point communication.

A photo of a transmitter ready for flight is shown on page 30. A chronometric pressure unit is shown on top of the case. This is a unit used to produce the pressure-indicating signals. It consists of an aneroid cell, a small 3-volt d.c. motor and an insulated drum with a metal helix and two closely-spaced metal contacts on its surface. The diaphragm of the aneroid cell is linked to a metal arm that rests on the surface of the drum. The position of the arm on the drum depends on the atmospheric pressure. The helix and the two contacts are arranged to close a series circuit consisting of a 90-volt battery and a 15,000-ohm resistor when the arm touches either of them.

The drum is driven by the motor. As it revolves, the arm touches the two contacts in turn and produces two *reference* pulses. As the drum continues to rotate, the arm touches to helix momentarily to produce a single *key* pulse. The time interval between the second reference pulse and the key pulse depends on the position of the arm on the drum. Since the arm is controlled by barometric pressure through the aneroid cell, the unit can be calibrated so pressure can be determined by the interval between reference and key pulses.

This type of pulsing mechanism can be used in a number of ways. The pulses could be used to key an audio oscillator that has been blocked with a high negative bias or even used to key the blocking oscillator so temperature and pressure signals can be transmitted simultaneously.

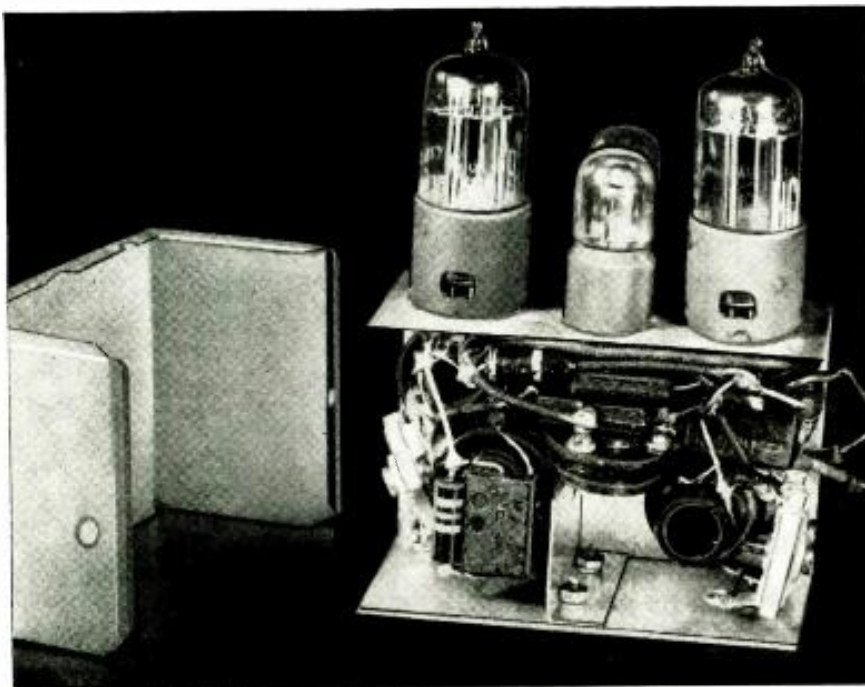

The FM transmitter. The vertical shield separates the oscillator and amplifier.

GAS-TUBE OSCILLATORS

The author discusses relaxation oscillators and points out the advantages of using thyratrons

By ALLAN LYTEL*

THE relaxation oscillator has been used as a sweep generator in television sets, but it has a number of definite disadvantages and has been practically superseded by other types. Its stability is not as great as that of the sweep oscillators used in modern television receivers, and the problem of getting a perfectly linear sweep is much greater. It is a fundamental circuit, however, and the student of television sweep circuits should be familiar with it as an aid in understanding such circuits in general. Moreover, it does find a wide practical field in oscilloscope time-base sweep generators, in which it is almost universally used.

The time-base generator is one of the most important parts of an oscilloscope. It furnishes to the horizontal amplifier a signal which sweeps the spot across the screen at the same time the test signal is moving it vertically. Without the horizontal sweep, the test signal would simply trace a thin vertical line, and it would be impossible to observe the shape of the wave.

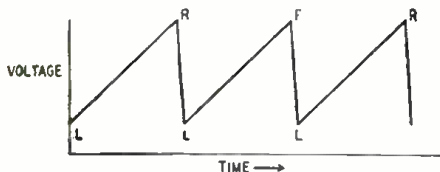

Fig. 1—Ideal oscillator gives sawtooth wave.

The signal needed for the sweep is shown in Fig. 1. When the voltage is lowest (the point marked L), the spot is at the left of the screen. As the voltage rises linearly, the spot sweeps across the screen at a uniform rate of speed. When the voltage is maximum (at R), the spot is at the right of the screen. The voltage then collapses very quickly, and the spot returns to the left of the screen so fast that it cannot be seen.

Because of the resemblance of the wave's shape to the teeth of a rip saw, the wave is called a sawtooth. For ideal

results the rise in voltage should be uniform; if it is not, a sine wave would appear compressed on one side of the screen and expanded on the other. The collapse of voltage must be as fast as possible—that is, the lines in Fig. 1 from R to L should be as nearly vertical as possible—so that the spot will be invisible when it is traveling from right to left back across the tube face. If this collapse is too gradual, the 'scope will show a horizontal line trailing from the right end of the observed wave toward the left.

The time-base generator which furnishes this saw-tooth wave in almost every general-purpose oscilloscope is essentially a simple relaxation oscillator. The basic circuit is shown in Fig. 2-a. High voltage is applied to a capacitor C in series with which is a resistor R and across which is a gas-filled tube V. This may be a neon lamp or a voltage regulator, such as the OA3, OB3, OC3, or OD3, depending on the B-voltage.

When voltage is first applied to the uncharged capacitor, the electron flow—electrons passing from one plate of the capacitor through the B-supply to the other plate—is very rapid. The rate of flow becomes slower and slower, however, as the capacitor becomes charged. All this time R slows up the charging of the capacitor because the current passing through R creates a voltage drop across it. This drop detracts from the voltage available to the capacitor. However, as the current gets smaller and smaller, this drop gets less and less, finally dropping off to zero when the capacitor is fully charged.

The gas tube has two electrodes, a plate and a cathode. There is no heater. The tube is filled with an inert gas which is responsible for the action of the tube. Neon in the tube is quite common, although there are several other gases that would serve as well.

With only a small applied d.c. voltage, the tube does not conduct. At a certain potential, the gas breaks down into electrons and ions. The electrons are negative and go to the plate; the ions



Relaxation oscillator furnishes time base for Dumont oscilloscope.

are positive and go to the cathode. The tube conducts heavily. The voltage that causes the tube to ionize and conduct is the ionization potential. After the tube breaks down the applied voltage may be reduced and the conduction will continue. At another voltage, lower than the ionization voltage and greater than zero, the tube stops conducting. This is the deionization potential.

The capacitor is capable of charging to the full potential of the B-supply. In practice, however, the B-voltage is made greater than the breakdown volt-

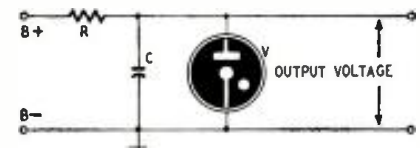

Fig. 2-a—This is basic gas-tube oscillator.

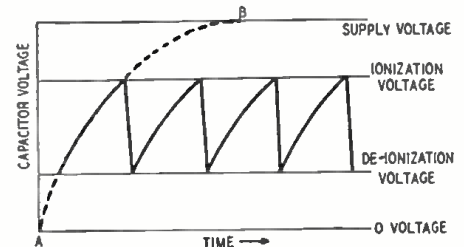

Fig. 2-b—AB shows normal capacitor charging.

age of V. When the capacitor has charged enough so that its voltage equals the tube breakdown value, the gas within the tube ionizes. The tube conducts.

Now the conducting tube across the capacitor is in effect a low resistance. It shorts the capacitor and causes it to lose its charge. The loss continues until the capacitor voltage is so low that the tube no longer has enough potential across it to maintain the ionization. It stops conducting. The effective low resistance is removed from across C, which is then free to charge up again.

Fig 2-b is a graph of the action just described. The dotted curve AB shows how a capacitor ordinarily charges. At the beginning voltage rises fast and

* Temple University Technical Institute, Philadelphia, Pa.

fairly uniformly; but, as the capacitor nears full charge, the rate of change becomes smaller.

In the circuit of Fig. 2-a, however, the maximum capacitor charge is limited to the ionization voltage of the tube. After the initial cycle, the minimum charge is limited to the deionization voltage of V . The circuit thus does two things: it causes the capacitor to charge and discharge periodically, and it restricts the changes in capacitor voltage to a certain part of the normal charging curve.

Note the resemblance between Fig. 2-b and the ideal saw-tooth sweep voltage in Fig. 1. The voltage rise is not quite straight; but if the supply voltage and the breakdown voltage of the tube are chosen correctly, only a comparatively straight portion of the curve will be used and the 'scope trace will be linear enough for most purposes. To get a fast discharge so that the return traces will be invisible, the tube should conduct as heavily as possible when it breaks down.

The frequency of the saw-tooth voltage can be controlled by choosing various values of resistance and capacitance. If the resistor is large, it will create a large voltage drop when the charging current passes through it. This will delay the application of full power-supply voltage to the capacitor and lengthen the charging time.

If the capacitor is large, more current must flow before it will charge to a given voltage. This, too, takes more time. To lower frequency, then, the capacitor or resistor (or both) must be increased in value. To raise frequency these values are reduced.

Fig. 3 shows one possible type of oscilloscope sweep generator. The switch selects various values of capacitance to allow a rough adjustment of the sweep frequency. The resistor $R1$ is variable and is used to make fine adjustments in frequency.

In order to stop the pattern on the oscilloscope screen so that it can be examined, the sweep frequency must be either equal to that of the signal or else a submultiple of it. To examine a 5,000-cycle signal, for instance, a sweep of 5,000 cycles will allow one cycle of signal to appear on the screen. A 2,500-cycle sweep would show two cycles, and a 1,250-cycle sweep would show four cycles. Sometimes sweeps higher than the signal are used. A 10,000-cycle sweep would show one-half cycle. In such cases the sweep frequency must be an exact multiple of the signal frequency.

Using the resistor ($R1$ in Fig. 3) to set the sweep frequency exactly (and it must be exact to make the pattern stand still) is a very difficult job. Even steady hands are not the solution because the frequencies of signal and sweep are always at least slightly affected by temperature and changes in line voltage. Some method of synchronizing the sweep with the signal frequency is always used. $R2$ in Fig. 3 is

the potentiometer used for synchronization control.

A portion of the test signal that is to be viewed is applied across $R2$. (This is done within the 'scope.) Let us suppose that this tube will fire at 100 volts. If the cathode is a ground potential, the tube will fire with 100 volts on its plate. As soon as the condenser reaches this voltage in its charging curve, the tube will conduct.

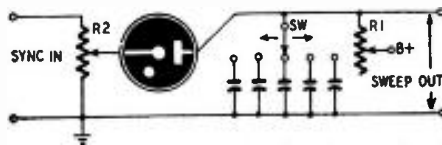

Fig. 3— $R2$ controls amplitude of sync signal.

If the test signal is a sine wave, it will increase and decrease the voltage at the cathode of the gas tube. Suppose that the signal that is applied across the resistance $R2$ has a peak value of 10 volts.

If the resistance arm is at the top, the full voltage of this 10-volt sync is applied to the cathode. When the sine wave reaches its positive peak, the cathode is 10 volts positive. However, this tube requires 100 volts from plate to cathode before it will fire or ionize. This means that the plate voltage will now have to increase to 110 volts before the tube will fire.

When the sine wave reaches the negative peak, the cathode will be 10 volts below ground or 10 volts negative. Since the tube needs 100 volts across it, the tube will now fire with 90 volts on the plate since the cathode is 10 volts negative. This means that the tube will fire at every negative peak of the applied sine wave. The sweep will then be at the same frequency as the signal being observed.

To make the sweep frequency one of the submultiples of the signal, the sweep frequency controls SW and $R1$ are adjusted to approximately the frequency desired and $R2$ is again advanced. If it is adjusted to one-third of the signal frequency, for instance, every third sine wave will cause the tube to conduct.

Advancing $R2$ too far and introducing too much sync voltage will destroy the linearity of the sweep voltage. Therefore, when using the 'scope, it is important to set the sweep controls as close as possible to the correct frequency—so that the pattern very nearly stands still—and then advance the sync control as little as possible until the pattern is stationary. On most 'scopes it should never be necessary to rotate the sync control more than a few degrees unless the signal being observed has a very low level.

A somewhat better (and more usual) sweep generator appears in Fig. 4. It uses a gas-filled triode or thyratron, such as the 884, 885, or 6Q5-G. In these, the grid can be used to set the breakdown voltage; if grid voltage is made more negative, the voltage necessary to fire the tube is higher. For this reason,

the sync voltage can be applied to the grid instead of the cathode.

Another advantage of the thyratron is that it passes more current when it breaks down than the neon or voltage-regulator tubes shown in previous figures; that is, its resistance is lower. As a result, the capacitor discharges faster, the return trace is less likely to be visible on the screen, and the generator can be used at higher frequencies. In addition, the breakdown voltage of a thyratron can be predicted more accurately, thus making it a more stable device. Since firing and deionizing potentials are adjustable (by means of grid bias), it is possible to adjust any given tube to operate on the most linear portion of the capacitor charging curve to obtain the most linear sweep.

Two refinements are included in the generator of Fig. 4. A limiting resistor $R2$ is in series with the usual charging resistor $R3$ to make adjustment of $R3$ easier. Without a limiting resistor, the lowest resistance settings of $R3$ would not be very useful, and some of the 270 degrees of rotation usually possible for a potentiometer would not be used. A second rotary switch SW is provided to change the source of sync voltage. In the INT position, sync is taken from the signal being fed to the vertical amplifier (or plates). The EXT position is connected to a terminal on the front panel so that any desired source can be used for sync. And placing the switch in the LINE position connects the 60-cycle line to the sync input for use as a sync source.

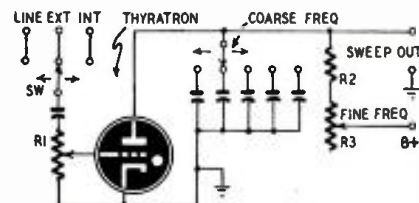

Fig. 4—This is a typical 'scope oscillator.

Ordinarily, oscilloscopes are provided with a vertical and a horizontal amplifier. Usually, the signal under test is fed through the vertical amplifier to the vertical plates. Almost invariably, the sweep generator signal (when it is used) is fed through the horizontal amplifier because it does not have sufficient amplitude to be fed directly to the plates. This has the additional advantage of providing a gain control (the horizontal amplitude control) which can be adjusted to make the sweep cover the screen or any portion of it which may be desired. Amplitude of the sweep signal determines the width of the pattern on the screen.

'Scope amplifiers must have good frequency response past the audio range. This is especially important for the horizontal amplifier because the saw-tooth wave form includes much harmonic energy. If this is not transmitted to the C-R-tube plates faithfully, sharp corners of the wave will be rounded off with resultant distortion of the pattern.

Radio Set and Service Review



The "Candid T-V" Model TV-37 is America's lowest priced teleriser, selling for \$99.50

A LOW-PRICE portable television receiver has finally been made available to the TV-conscious public. Pilot has come out with its "Candid T-V" Model TV-37. Its 3-inch cathode-ray tube produces a picture 2 inches high and 2½ inches wide. Housed in a mahogany-finished Masonite cabinet 14½ inches wide, 13¾ inches deep and 9¼ inches high, it is just the right size for a student's desk or for a small table in a busy executive's office.

It operates from 105-120-volt 60-cycle a.c. lines and tunes channels 2 through 13 in two bands.

Weighing only 14½ pounds, it is easy and convenient to carry on vacations and business trips. An indoor-type antenna made of 300-ohm ribbon transmission line convenient for placing under a rug or hanging on a wall is furnished with the set. A leatherette-covered carrying case with a built-in telescopic dipole antenna can be obtained if desired.

The set is easy to operate. Panel controls are: ON-OFF VOLUME, BRIGHTNESS, TUNING, and CONTRAST. The power switch is on the volume control and operates in the usual manner.

The tuning control consists of a variable condenser shaft and bandswitch with concentric shaft. Channels 2 through 6 are tuned with the bandswitch in the Low position and 7 through 13 with the control set on High. Continuous tuning is used between stations on each band. The variable-condenser tuning, a novelty in TV receivers, appears to work very well. Pilot's copper-plate condensers, first seen in the Pilotuner, are used.

Hold, centering, and focus controls are on the rear chassis skirt. They are provided with insulated knobs with slots for screw-driver adjustment when necessary.

The set uses transformerless power supplies with one side of the line connected directly to the chassis. This does not constitute a shock hazard because the set must be fully enclosed in the cabinet before power can be applied through an interlock type of power cord. The control shafts are insulated

from the chassis so as to avoid shock, even with the control knobs removed.

The circuit

The circuit of the set is shown on page 37. The 21 tubes and their functions are: 12AT7, high- and low-band r.f. amplifier; 12AT7, high- and low-band mixer; 12AT7, high- and low-band oscillator; four 6AU6's, i.f. amplifiers; 6AU6, ratio-detector driver; 6AL5, ratio detector; 35B5, a.f. amplifier; 6BA6, video amplifier; 6AU6, sync amplifier and d.c.-restorer; 12SN7-GT, horizontal multivibrator; 12SN7-GT, horizontal amplifier; 12SN7-GT, vertical multivibrator; 12SN7-GT, vertical amplifier; 35W4, negative rectifier; 25Z6-GT, positive rectifier; 25L6-GT, oscillator (r.f. power supply); 1B3-GT, high-voltage rectifier; and 3KP4 cathode-ray tube.

The front end or tuning assembly of the set uses separate oscillators, r.f.

amplifiers, and mixers for the high and low bands. Each band has its own coils, tuning condensers and tube circuits. The bandswitch connects antenna and B-plus to the section in use. The tubes in the front end are duo-triodes, one-half of each tube operating on the high and the other half on the low band.

The r.f. amplifiers are of the grounded-grid type, coupled to the antenna through fixed-tuned band-pass transformers adjusted with 30- μ f trimmer condensers. The r.f. amplifier plate circuits and mixer grid circuits are coupled through band-pass transformers with primaries and secondaries tuned by the front and middle sections of their respective tuning condensers.

The oscillators use tuned-plate untuned-grid circuits. The underside of the set is shown in Fig. 2. The front-end assembly is on a sub-chassis at the front of the set. The oscillator and r.f. coils are on the forms on each side of the three tube sockets on the sub-chassis. The construction of the oscillator tickler coils is novel. These coils, L1 and L2, are silver-plated brass

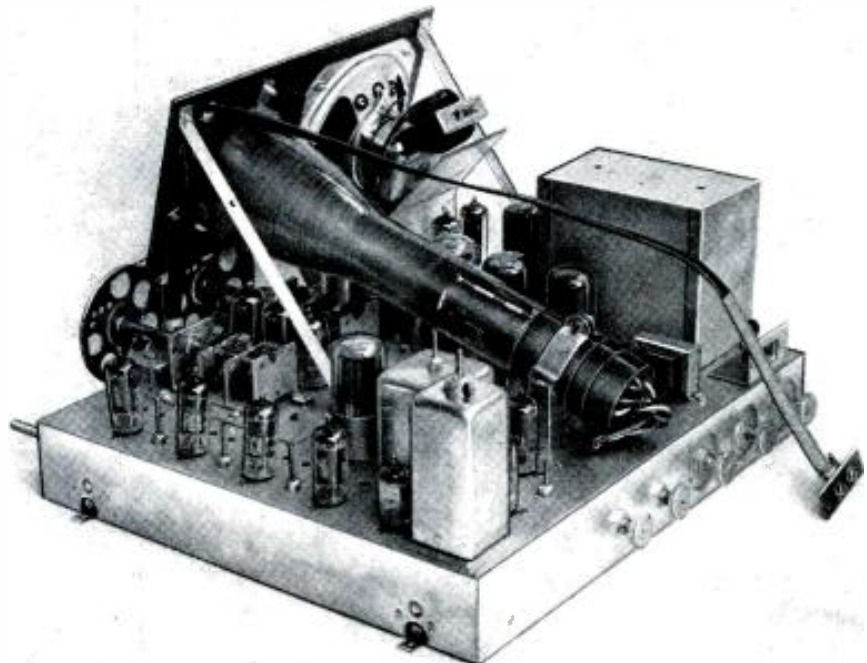

Fig. 1—This set employs separate tuning condensers for high- and low-band TV channels.

right-angle brackets fastened to the chassis so the sides pass close to the oscillator plate coils. The coupling between the ticklers and the mixer grid coils is sufficient to provide injection for the mixer. L1 and L2 are pointed out in Fig. 2.

The receiver uses the inter-carrier system—the common i.f. amplifier strip passes both video and audio signals simultaneously. Impedance coupling is used between the stagger-tuned i.f. amplifiers. The first i.f. stage is fed from a 23.5-mc permeability-tuned coil common to both mixers. The first, second, third and fourth stages are tuned to 25.6, 22.0, 21.6 and 24.8 mc respectively.

Semi-fixed bias is used on the grids of the r.f. amplifiers and on the first, second, and third i.f. amplifiers. The amount of bias is adjusted with the contrast control.

The video detector is a 1N34 germanium diode. It is in a can along with a sound trap, L3, tuned to 21.25 mc to prevent sound from reaching the grid of the video amplifier. The detector is followed by a 6BA6 video amplifier compensated for flat response to about 3.8 mc. The output of the 6BA6 is capacitance-coupled to the cathode of the 3KP4 cathode-ray tube.

The sync voltage developed across

the 5,600-ohm video amplifier load resistor is coupled to the grid of a 6AU6 sync amplifier. This tube, a class-AB2 amplifier, amplifies the sync signals and passes them through integrating and differentiating networks to the horizontal and vertical multivibrator-type sweep oscillators.

Since the sync amplifier operates class AB2, the d.c. voltage across its cathode resistor varies with the average peak-to-peak signal amplitude. This voltage corresponds to the d.c. component of the picture. A part of the voltage is tapped off and applied to the grid of the C-R tube for d.c. restoration.

The sweep voltages are developed by 12SN7 multivibrators. Each one works into a 12SN7 push-pull deflection amplifier. The horizontal oscillator plates are grounded through load resistors and the cathodes are connected to a negative supply used for bias. The horizontal size is controlled by a trimmer, T8, across the output of the oscillator. Linearity is controlled by the combined settings of T8 and another trimmer, T9, between the plate of T1 and the grid of T2 in the horizontal amplifier tube.

The vertical oscillator has its plates connected to B-plus and cathodes to ground in the conventional manner.

The vertical size is controlled by the setting of the 5-megohm resistor, a part of the load resistance of T2, one of the multivibrator triodes. Vertical linearity is maintained by the feedback network consisting of two .0015- μ f capacitors and a 1.2-megohm resistor between the plate of the multi-vibrator triode T2 and the grid of the vertical amplifier T1.

The vertical and horizontal hold controls are variable resistances in the grid returns of the second multivibrator triodes. They control the frequencies of the oscillators by changing the time constants of the circuits.

Focusing is adjusted by varying the voltage on the focusing electrode.

The plates of both deflection amplifiers are connected to the B-plus supply and the cathodes to the output of the negative or bias supply. This arrangement increases the effective plate voltage on the amplifiers and provides sufficient sweep voltage for the deflection plates.

High voltage for the C-R tube is developed by an r.f. power supply. This is in the large can on the rear of the chassis, Fig. 1. The plate and screen of the 25L6-GT oscillator are returned to ground and the cathode to the negative supply. R.f. feedback to the oscillator grid is picked up by a spring clip around the lower end of the 1B3-GT high-voltage rectifier envelope.

There are two B-supplies in the set. One, using a 25Z6-GT, delivers about 120 volts positive with respect to the chassis. This tube feeds all tubes in the set except the sync amplifier, horizontal oscillator, and high-voltage oscillator. The other, using a 35W4, develops a negative voltage and supplies bias throughout the set as well as operating voltage for tubes not supplied by the 25Z6-GT.

The heaters of the tubes are connected in series-parallel filament strings with R-C filtering between most of the tubes.

The set was tested for several weeks in a number of New York City locations and was found to work nicely in all of them—even when using the 300-ohm indoor antenna. It was not possible to eliminate ghosts in all locations. This, of course, is to be expected when no special precautions are made to orientate the antenna. The set is very stable and it was not necessary to retune the set after it was turned on.

The line cord is connected permanently to the back of the cabinet. This prevents the set owner from operating the set with the cover removed, thus exposing himself to shock. This is an excellent feature for the owner but not for the poor serviceman who tries to service the set. He can't check the receiver without removing it from the cabinet and he won't be able to supply power to the set until it is in the cabinet. This handicap to servicemen was mentioned to the manufacturer and it was stated that very likely in the near future, line cords minus cabinets would be made available to servicemen on request.

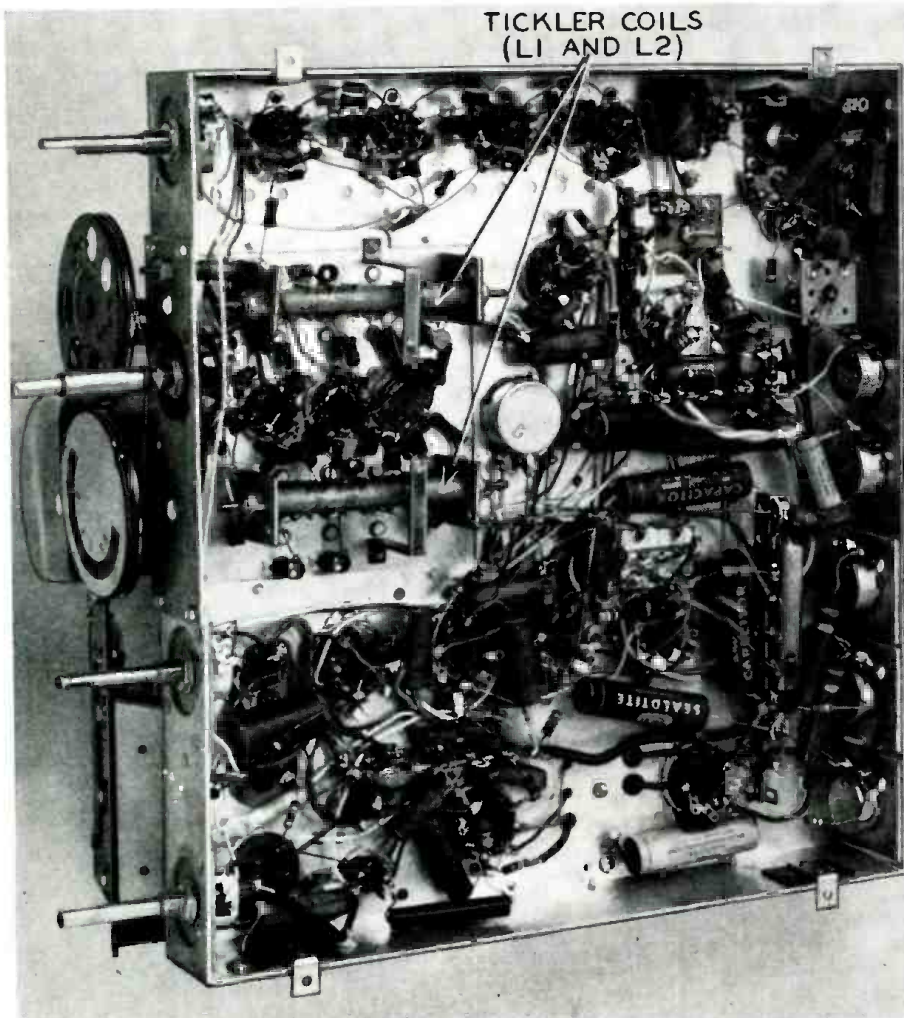
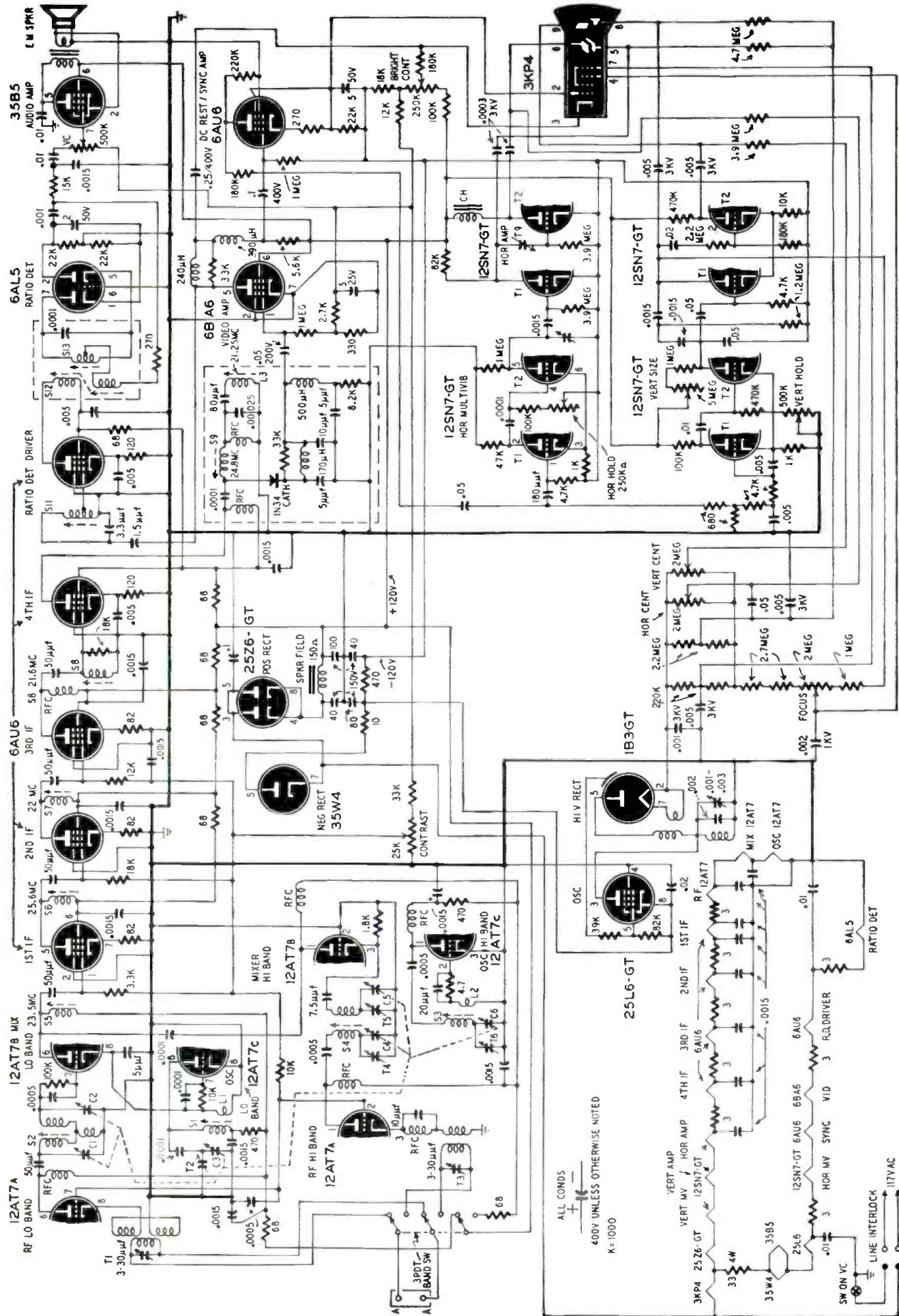

Fig. 2—Dial drums are on the two tuning condensers. Arrows show novel tickler coil straps.



Pilot Radio's Candid Television Receiver Model TV-37, an a.c.-operated televiewer with a picture 2 x 2 1/2 inches in dimensions, and weighing only 14 1/2 pounds—almost a portable television set.

Rolling Our Own Output Transformer

Another Langham high-fidelity adventure



All photographs courtesy U. S. Navy

This is one of several ways to make the form.



Finishing the form. Forms may also be made of electrical fiber scored and folded square.

By J. R. LANGHAM

THE first time I ever wound an output transformer was way back when. I was just getting interested in radio, and the XYL was just a YL. I wasn't even in the radio business—I was just an amateur. Money being very scarce those days, I could not afford to buy a decent output transformer for my amplifier. I had a little open-frame 39c special and blamed it for the distortion and the short frequency range. I ached to be able to spend ten or twelve bucks for a hi-fi job, but I just didn't have the long green stuff.

It was the YL who put this particular bug into my head. "Why don't you make your own?" she suggested.

"Me? Wind a transformer myself?" It was absurd. Transformer winding was an esoteric art reserved for the mysterious high-priests of electronics. It was unthinkable—but I thought of it just the same. I heard of a guy who wound transformers, and I made a pilgrimage to see him. He talked, I listened. I bought some beer and was respectful, and he gave me an old burned-

out 300-ma power transformer and some insulating paper.

"Here," he said. "This'll make you a honey of an output transformer."

I gulped. "How do I go about it?"

"First un-pot it and knock the laminations apart. Heat them up and then let them cool slowly so they'll get soft. Measure your window carefully and decide how many turns you want of what size wire. You know your impedance ratio, so you know the turns ratio. Get a wire table. Make the primary about half the space available. Put in at least

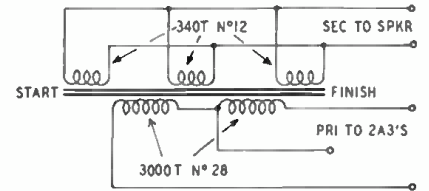

Schematic and specifications of the windings.

three secondaries and parallel 'em. That's to give good highs. Design it."

I gulped and went home with my booty. I melted the tar out and pulled the ugly thing out of the case. I hammered the laminations apart and cooked them in an electric oven over at the technical school. That was to anneal the iron and soften it. It had to cool slowly to do it. I spent a morning easing the temperature up slowly, and then I just shut the oven off and left the laminations in there with the door closed. That was on a Saturday, and I came back on Monday to take them out.

Well, the textbooks gave me most of the dope: the efficiency varies with the amount of copper in the window; bass response is determined by the primary inductance; treble response depends on the leakage inductance (mostly). I knew I wouldn't have to worry about capacitance because it was to be used

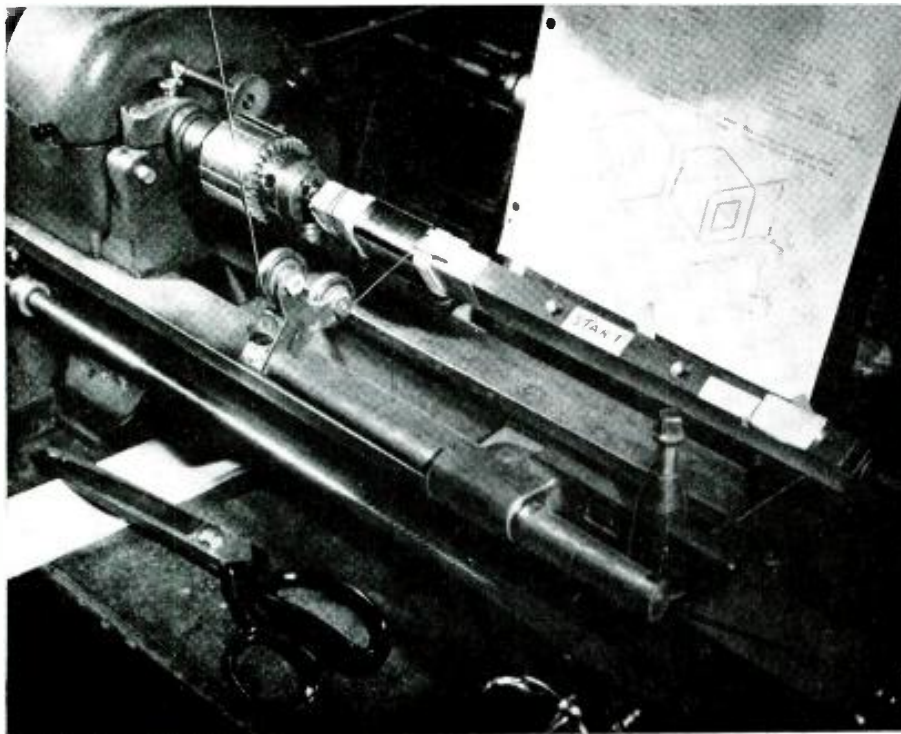

Above, left—First layer wound in place. To start second layer insert glassine paper under wire so that wire is at least one-eighth inch from paper's edge, and roll it on with the next turn of wire. (Photo right.) Paper secures and stiffens ends of windings.

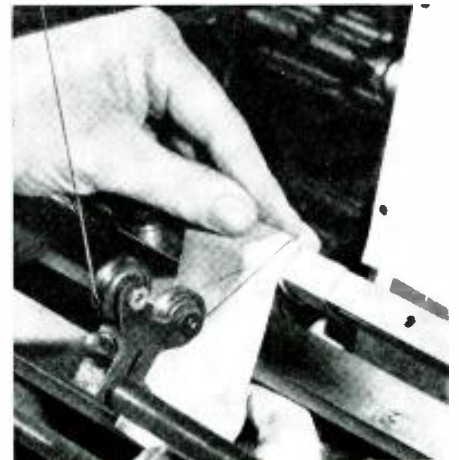

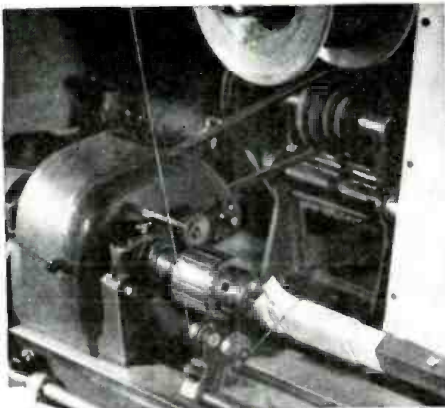

Should an end turn cut through the glassine, lay a strip of paper under it as shown above,

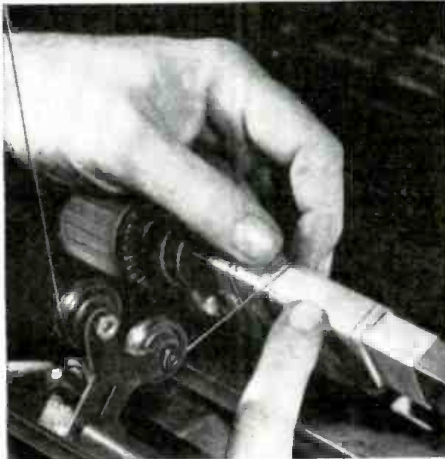

and loop it back, winding other turns over it. Pull the loop up snug after a few turns.

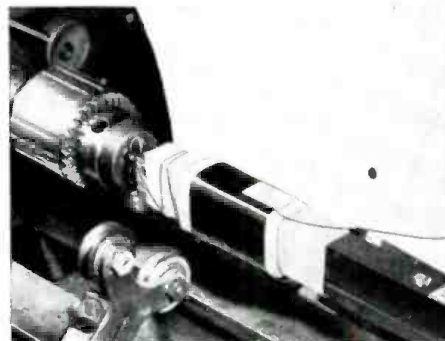

Finishing winding. Place paper loop as shown, wind a few turns over it, pull up loop ends and continue. On next (last) layer pull end



turn through and pull loop ends tight. If winding ends midway, use loop as above, wind a few turns over it and slip end turn through.

from tube to speaker and therefore was a low-impedance affair. My impedance ratio was from a pair of 2A3's to a 16-ohm voice coil and amounted to 5000:16, or 312.5. I knew the turns ratio had to be the square root of that: 17.7 approximately. Plain arithmetic gave me that and it meant there had to be 17.7 primary turns for each secondary turn.

I forget now just what the dimensions of my window were, but I remember deciding that 6,000 turns of No. 28 wire would come very close to filling the bill for the primary. The figure of 6000/17.7 meant 340 on my secondary would get the needed impedance ratio.

My friend had told me to make at least three secondaries. That didn't really mean much so I called him on the phone. "Why, it's simple," he answered. "To get good high-note response you have to have good coupling. So make three secondaries: one next to the core, another between the two halves of the primary, and the third on the outside. That way you get better coupling between the primary and secondary. Just tie all three of the secondaries in parallel."

"But I figured 340 turns for my secondary and . . ."

"That's fine," he said. "Make three of them and tie 'em together. Just use a smaller-size wire so you can accommodate three 340-turn windings."

"But about this high response business," I said. "The books say it's a matter of leakage inductance and . . ."

"That's just a measure of the coupling. With low-impedance stuff the coupling is all that limits your high notes. Forget the capacitance."

I sat down again with my wire tables and figured. 3×340 meant 1,020 turns had to go into that space and, what with the thickness of the insulation—hmmmm. No 12 wire ought to be about right. A trifle light, but No. 11 would be too big. I drew up my winding sketch. (See diagram.)

Now came the big problem: how to do the actual winding. There were several lathes over at the technical school, and the management said I was welcome to use them if I'd clean up after myself. I promoted a counter that could be attached to the end of the spindle to keep track of the number of turns. I still had the old cardboard winding form and I stripped all the old wire off it. Then I sawed a piece of wood that fitted nicely into the form and bought my wire.

One more visit to my transformer friend showed me how to tape the ends of each winding layer, and then I started. It went much easier than I had expected. Actually it wasn't hard at all. Tedious, but not at all difficult. It took the better part of the day, what with attaching the counter and setting up a roller for the spool of wire to feed from. I wore heavy gloves and fed it by hand. Cutting the insulation carefully with a pair of shears, I taped it as neatly as possible.

The YL and I had a date that night, and we spent it fitting the laminations into and around the winding and then

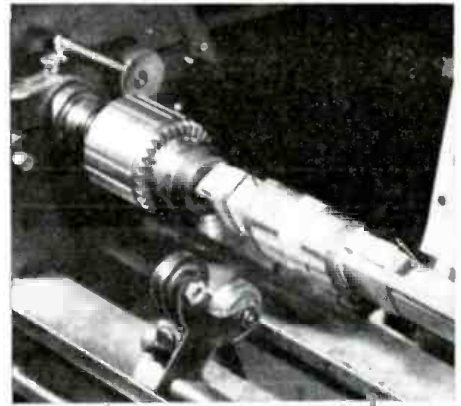

Winding finished with final paper wrapping and a strip of adhesive to hold it secure.



Putting insulating fiber between windings evens up the surface and provides insulation.

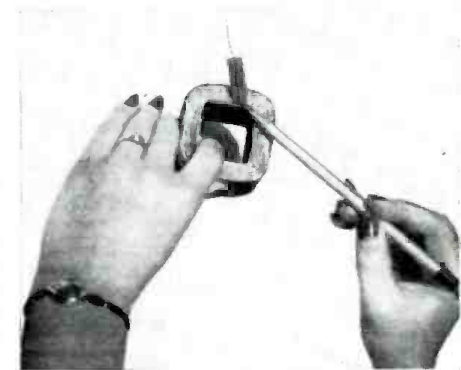

Finished job, showing method of attaching lead wires. These connections are usually

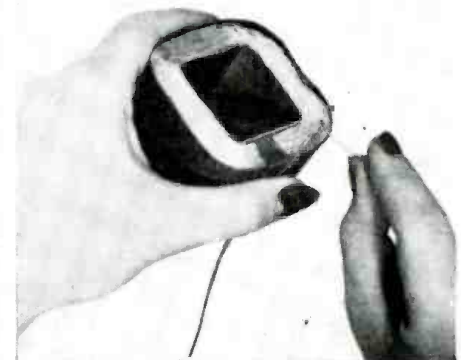

made in the interior, between windings, and are held securely by the windings over them.

re-potting the transformer. Her mother still resents the fact that we used a saucepan to heat the tar and pour it into the case. We cleaned it, but I guess we didn't get it as clean as she thought we should have. Tar wouldn't hurt her anyhow. We used to chew it when we were kids.

The transformer was still warm when we bolted it onto the chassis and



Soldered wire is covered with another piece of insulation, held down with some coil cement.



Adhesive strips make external connections stronger. Whole winding may be taped also.



Last job of all is inserting laminations. This is not hard to do if all the dimensions are correct.

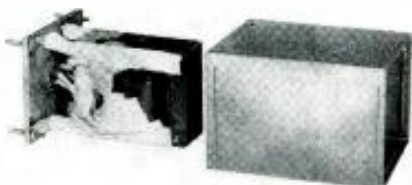

The transformer is now ready for repotting. But don't forget to give it a test run first!

soldered the leads in. We hadn't checked it for shorts or opens or anything, just hitched it up and tried it out. It worked fine. I swore I could hear lows and highs that hadn't been there before. The old 39c open-frame job was given to the YL's kid brother who was building a set at that time.

But that transformer had faults. Several of them. The two halves of the primary weren't balanced properly, and the whole unit was too big and clumsy. My finances improved, and the YL became my XYL, and before long I could buy a big, fancy output transformer and build a new audio amplifier. That old wreck was kicked around the house for a couple of years before it was given, traded really, to a chap I knew. I had never run a test on it at all while I had it.

The new owner *did* run a test. I was amazed when he gave me the results. He used it in a class-B 6L6 PA amplifier and ran loads of current through it. The amplifier conked out one time, and he put an audio oscillator into the circuit as a sort of signal-tracer deal. He found the trouble and then idly twisted the dial on the thing. It went right down to 20 cycles on the bottom and (he said) up to 16 kc on the top. I frowned when he told me, so he unshipped the big brute from the chassis and made a bench test. The half-power points on the curve were 11 cycles and 23 kc. Those were where the level dropped 3 db. The efficiency was 87% and there was no sign of distortion at 30 watts, which was as much as he had available. All this too, was without feedback, mind you.

It sounded as though it were better than the transformer I had bought. The curve on that was supposed to be 1 db from 20 cycles to 20 kc but it conked out at 12 kc on the top.

I got a new job around then in a laboratory and was put to running bench tests on a whole series of standard transformers. I found an amazing thing: None of the "high-fidelity" transformers tested would meet their published curves. In fact, most of them didn't come near them. There were only two brands among all those I tested whose transformers *all* came up to their own specifications. Since our work involved Sonar listening gear we had to have the highest possible fidelity in transformers for faithful transmission of submarine sounds. We soon found we could not get enough really good transformers from the busy companies and so we had to wind a lot of our own.

The winding was done much as I had done it. I managed to get those photographs from the U. S. Navy. They show the work done in that laboratory in making up a transformer—and we made a great many of them.

I have since wound up more output transformers for my own outfit and for those of some friends. I use essentially the same technique as with that first hoary old model. I try to find a big old power transformer that someone has

burned out and rip the old windings off it. I anneal the laminations and then design a new winding. This is really very simple and takes just a little figuring. You have to remember these things:

1. Fill up the window with copper. Fill it as full as you can. This governs the efficiency.

2. As a rule of thumb, allot half your space to the primary and half to the secondary. It works fine.

3. Have plenty of turns for the primary to get good low-frequency response. I never use wire larger than No. 30 any more. Even with 6L6's the transformer still runs plenty cool. For 2A3's you can use even smaller wire if you wish. Lots of turns.

4. Have several secondaries in parallel for your coupling. At least three. Five is even better. Put them here and there and all over and then just tie them together—but watch your polarity.

5. If it's to be for a push-pull amplifier, wind both your primaries at the same time from two spools of wire. That way you can get a good balance and keep down the intermodulation distortion. Make them in two sections or three, interleaved with the secondaries; but if you wind both primaries together, you'll have a good balance.

6. Lay the turns in closely and don't let any over laps stay in. Go back and remove them.

7. Don't use transparent sticky tape if you live near water. Get thin cambric tape and regular thin paper insulation from your supply house.

As to what kind of power transformer is best—that's up to you. The bigger it is, the easier it is to get enough primary turns for good bass response. Just get yourself a wire table and study the turns-per-inch of the different sizes. Don't squeeze it. A thousandth of an inch too little means a slight loss in your efficiency, but a thousandth too much means you can't get the laminations back together and you'll have your work for nothing. Measure your insulation thickness and plan the whole thing carefully.

You might be arguing to yourself now, "Well, if it's so easy, why don't the companies make transformers that are as good?" I'll tell you why. The economics are agin it. You're worrying about one transformer — your own. They have to think in terms of a thousand or more. Extra wire, extra insulation, and larger cores run up the cost considerably and then they couldn't compete with the others' prices.

You can have any coil-winding firm make you up a special transformer to your own specifications, and it will cost you plenty. Or, if you're a working stiff without much lettuce, you can look around for an old, burned-out 300 ma power transformer and, with a little work, make yourself a really fine output transformer.

It's really easy and, what's more, a lot of fun. Try it.

Columbus Set For Video

One city's servicemen prepare to meet the problems of television

By DAVID GNESSIN

COLUMBUS, OHIO, does not yet have its own television station. It is a healthy 100 miles to the nearest TV transmitter at Cincinnati. Yet the numerous TV dipoles and reflectors on Columbus rooftops amply testify that Columbusites—their appetites whetted by the occasional fringe reception of television signals from other cities—are anxiously awaiting 1949 when the first of three TV transmitters opens regular schedules in this capital city.

The radio servicemen and dealers in this town, long banded together for mutual gain and public service through the *Associated Radio Service Dealers of Columbus* (ARSD), realizing the imminence of television, took matters into their own hands by organizing study chapters on this subject as a regular feature of their monthly meetings. Fred Colton, the red-haired sparkplug of that organization, spearheaded the effort as chairman of the Education Committee. Using the regular Television Course now available in the *Sams Photofact Series* as text, the group started by reading the lessons at home, then bringing up their questions at the meeting.

The system worked so well they invited guest speakers to handle the advanced questions, which were rapidly reaching the stage where the cooperating member dealers found difficulty in finding satisfactory solutions. Here they were, out of the regular service area of scheduled TV stations, yet besieged by eager buyers thirsting for television and demanding they be supplied, maintained, and serviced.

The first of these really professional seminars in television took place Thursday, August 12, in the large basement of the Buckeye Radio Lab. The guest speakers (see photograph) included Paul Wendell and William Hensler, both of the Howard W. Sams Institute of Indianapolis. These engineers were happy to offer their expert opinions on television as seen by the serviceman. That information was of necessity limited to the bare two years or less that television has been available in any measure to their own Indianapolis.

The speakers were besieged by the service dealers, who were anxious for any practical information on the subject. Prominent in their minds was the worry about the dangerous voltages found in TV sets. It was contended that



Al Ray, ARSD president, Paul Wendell and Bill Hensler, visiting engineers, and Fred Colton, chairman of the Columbus association's educational committee, shown in the usual order.

since C-R tubes require high voltages, these should be recognized as dangerous and care should be taken to insure safety in servicing.

The Columbus servicemen brought up the question of servicing sets with many different stages, any of which might be inoperative and affect the general operation. The speakers made the reassuring reply: "Under most general conditions, the television receiver, by its own C-R pattern, provides its own test instrument, showing the trained serviceman the errant stage, immediately localizing the trouble—making the servicing job considerably simpler than the tiny a.c.-d.c. job with the elusive intermittent which takes hours to locate." This theory is strongly supported by John R. Meagher, of RCA Television Service, who states in the current *RCA Service News*, (see reprint in November issue). "If we learn to recognize these visible symptoms, we can quickly localize the trouble to a particular portion of the set. *In no other type of electronic equipment are the troubles and symptoms so clearly displayed before our eyes!*"

The attending dealers were further cheered to find that their worries about stocking a large pile of expensive C-R tubes for servicing all the different types of TV receivers was groundless. In the first place, the high mortality of C-R tubes in the laboratory assures extremely low loss of picture tubes in the field. Secondly, the visiting engineers

could name only four different types of C-R tubes in general use in commercial TV receivers, indicating an extremely high degree of standardization on this relatively high-priced item. Finally, the other tubes in the TV receiver are practically duplicates of the FM numbers already stocked by service shops in general practice.

The engineers made it a point to mention that even at that meeting, as the servicemen were making notes of the replies of the speakers, the guests were making notes of the questions for use in future Photofact service notes, as practical aides in the servicing field. In that regard both the publishers and servicemen pledged each other continued support for their mutual betterment.

The practical demonstration of alignment at the seminar brought out a unique point possibly overlooked in routine servicing. In TV service, merely moving the wiring aside to get at the solder terminals varied the constants enough to affect circuit alignment. So remember, replacing that open condenser isn't quite enough from now on—replace those leads *exactly as you found them*. The radio manufacturers have taken to separating the different circuits to avoid confusion. While simplifying assembly (the prime reason for this separation) the new technique exposes wiring terminals for ready servicing. *It took television to do it—but it was worth it!*

Coin Radios—A Good Business

How one serviceman became his own boss

By JAMES Mc DANIEL

MANY radiomen have a great desire to go into business for themselves instead of working for someone else. Having the same urge about a year ago, I decided to investigate coin-operated radios.

I began by visiting several banks, with the idea of getting a loan to finance the business. None of the banks had ever heard of coin-operated receivers, but the bankers were enthusiastic and advised me to go ahead immediately.

The next step was a trip to the company making the radios. Here I was shown through the plant and given demonstrations.

The next day I visited several hotels and signed contracts for installing the sets in guest rooms.

The receivers

Because I am a radio technician, keeping the sets in good condition has been no problem. The sets are standard a.c.-d.c. jobs with slug tuning. They are very selective and have plenty of volume.

There is a master volume control locked inside the case so that only the serviceman can get at it. This is set so that no matter how high the customer turns his volume control, the people in the next room won't be annoyed.

The timing box, the mechanism which determines how long the radio will play, occupies a separate compartment, which is locked. The owner can set the gear

more than the basic one- or two-hour period.

The timing mechanism sometimes jammed when the starting plunger was pushed down too soon after the coin was deposited. The result was that the radio would not operate, even though the coin was accepted. The hotel manager made refunds in these cases and I reimbursed him. The problem was much less important after the public became used to operating the sets.

The coin box will hold about \$40 worth of quarters, so that collections do not have to be made too often. The coin mechanism can be disconnected in case the owner wants the set to play like any home receiver.

tennas. The models made for luncheonettes and other eating places give 15 minutes of listening for a dime.



The white hospital model has pillow speaker.

Business problems

One of the prime necessities is to protect the radio and the coin box from a few misguided hotel customers. The familiar towel-and-soap stealers need very little encouragement to become radio-and-coin thieves. The sets could be screwed to walls, but most hotel managers don't like this; so I furnish small tables, to which the sets are fastened and which are bolted to the floor.

I have found the burglar alarm shown in the diagram very useful. A normally open microswitch is installed in each receiver in such a way that the back of the case presses the contact lever, making it close. Leads from each switch are brought down to the hotel manager's office, where current from the transformer secondary flows through all switches in series with the normally closed relay. This keeps the relay contacts open.

If a guest tampers with a set, in removing the back he will make the microswitch open. If, for instance, his set is the one in which S1 is installed, S1 will open. The 1.5-volt pilot lamp PL1 is then placed in series with the relay coil and it lights. The added series resistance reduces relay coil current so the contacts close, making the bell ring. The manager, summoned by the bell, sees that PL1 is lit and knows just which guest is tampering with his radio.

This is admittedly a big installation job if there are many sets in the hotel. However, the mischief done by guests can be so costly that it is well worth while.

The arrangements made with the owner of the hotel or other place where the radios are installed will, of course, vary. The average income from each of my sets is about \$3 per day. Of that 25% goes to the hotel owner. However, after the purchase price of each receiver has been paid out of the profits, the hotel owner's portion can be increased.



Luncheonette set gives 15 minutes for a dime.

Other installations

Although I have installed receivers so far only in hotels, several other types of sets are made—for beauty parlors, hospitals, luncheonettes, motels, tourist camps, and so on.

Those for beauty parlors have an ear-phone attachment so that customers can listen even when they are under hair driers or while they are being worked on. The new "stethoscope" phones are used. They fit under the chin instead of over the head so there is no interference with the beautician's work.

The special model made for hospitals has a white-painted cabinet and provision for attaching a pillow speaker to avoid bothering other patients. The maker probably kept in mind the fact that hospital patients generally have plenty of bills to pay, because the timing mechanism in the radio is geared to play three hours for 25c. In a hospital where these receivers are used, interference from X-ray machines, fluorescent lights, and other medical equipment has been very small, in spite of the fact that the radios have no external an-

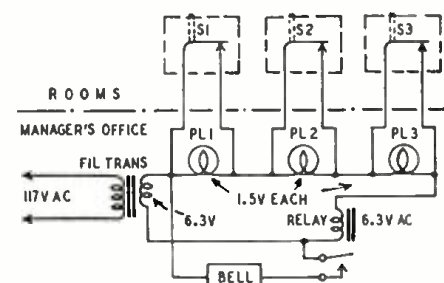

Burglar alarm guards any number of receivers.

ratios so that the customer will get either one or two hours' playing time for 25c.

I chose the one-hour timing, not being quite sure just what the customers would consider fair. If they seemed to think one hour was not enough, I could increase the time to two hours and everyone would be happy. But if I started with two hours and then cut down to one, the users would feel they had lost something and would complain. So far, one hour has worked out nicely.

As much as \$3 in quarters can be put into the coin box at one time so that the customer can listen uninterruptedly for

ARE you charging \$3 an hour for your servicing time? Maybe you should—or maybe you shouldn't.

On vacation in a strange town, I needed a set of tubes tested, so I went to a newly opened service shop. I stated my errand and asked to borrow an ohmmeter. The man behind the counter told me, with a laugh at my ignorance, that all I needed was a continuity tester.

Borrowing the shop copy of the RCA Tube Manual, I was unable to find my tubes listed; the manual was an old edition. Taking pity again on my ignorance, the serviceman made the continuity test and found that the filament of the 35W4 was open. Then we started to talk.

"I noticed your ad," I said. "You didn't state your experience."

"When I opened up," he told me, "There was quite a piece about me in the local paper. As a matter of fact, I have a master's degree in electrical engineering, but I don't believe in bragging about it."

"Well," I replied. "I still don't see how the average person—especially a stranger in town like me—can tell whether he ought to bring work to you. As a matter of fact, I understand most of the local people take their sets to a nearby town where there's a ham with a good reputation."

Said he: "After people learn that I do good work, they'll bring their sets here."

The conversation was friendly enough, but even in resort towns people aren't in business for their health. "How about a new 35W4?" he said with a mental glance at the cash register. My own mental picture revealed shelves of assorted tubes in my own workshop, so I declined. He relaxed again and put his elbows on the counter.

"Do you do much service work?" he asked me.

"No, just occasionally. I'm sort of a radio tinkerer," I told him, "and once in a while I write an article for a radio magazine."

A smile passed across his face and he stabbed a hole in the air with his forefinger. "You know," he said, "we have one of those tinkerers here in town—hit-or-miss boys, I call them. Now, when I was working as a production engineer, I had to inspect and pass on 350 to 450 sets before I could say I'd done a day's work. After you've tested 'em day in and day out you get so you can tell what the trouble is by the sound. For instance," and he poked the air again, "you hear a hum. How do you know what's causing it?"

"Well," I answered, "first you suspect the power-supply filter, then a leaky tube, usually the output tube. You substitute condensers in the filter and put the tube on a leakage test."

"Heck, no," he laughed, "you don't have to go through all that—all you have to do is listen!" He became serious. "Too many radio men are charging the customers for their own lack of

SCREWDRIVER, VOLTOHMMETER AND BRAINS

By H.A. NICKERSON

knowledge. A radio set has one of two troubles, either an open or a short. All you have to do is find out which it is and fix it. Oh, I know," and he brushed aside my unspoken objection, "it might be an intermittent. But any good man ought to be able to find that in an hour at the most."

He turned to the workbench and I took a look around the shop. I noticed a volt-ohmmeter, apparently one of the vest-pocket models with a maximum range of 1 megohm. There were some resistors and condensers, too, and a collection of tools.

As I stood there, he aligned a five-tube "ack-dack," as he called it, by ear. As he jarred the chassis after putting in a new tube, I heard a scratchy on-and-off effect from the speaker.

"In my ignorance," I volunteered, "that sounds like trouble in the new tube."

He admitted my ignorance. "How could that complete on-off effect come from a tube that draws such a small current? It must be in the i.f. transformer." He hit transformer, tube, and chassis, all with equal effect on the noise. (He hadn't found the answer by the time I left.)

As he worked, he started talking about servicing fees. "The real radiomen in this locality got together," he told me, "and agreed to charge \$3 an hour for service, with a flat charge of \$1.50 for going to a customer's home."

I posed a question. "What do you do about the fellow with the old set worth \$15 that you work on for three hours, digging out old bypasses and replacing them?"

"Oh, I charge list prices for the parts and the hourly rate for the time. But it would never take that long to do the job."

"My system is different," I told him. "If I have to work for four or five hours on some old relic, I don't charge what my time is worth; I base the charge on what the set is worth. Then if someone comes in with a set that takes me only a minute to fix, I make up the previous loss with my charge for the short job."

"Ah!" he said, turning around so I could see the triumphant look on his face. "That's why those surveys found so much to complain about. You're gypping the customer with the small job."

"Well," I argued, "someone has to pay for bookkeeping, answering the phones, and sweeping up the floor—to say nothing of the rent."

Now he was indignant. "You just can't charge that to the small job," he laid down. "It's people like you," and he shook his finger in my face, "who give the radio serviceman a bad name. You should charge for your time, and you should charge everyone the same rate. On those long jobs you're just charging the customer for your inexperience anyway."

I had an answer for that. "If I charged for my time on some jobs, the customer would hate me forever. You take your car to some garage, and someone fools around with it for a long time and you have to pay for that time. But next time you'll take it to a better mechanic. I don't expect to get paid for being slow. I should get paid for being fast; if I can locate trouble in a hurry. I'm a specialist and I can charge more for my time. I've known plenty of good radiomen who spent hours on a set and then found some soldering flux in a pilot-light socket. According to you, they should have found it right away, by just listening to the set."

"If they took three or four hours to find a little thing like that," he said, adamantly, "they were just tinkerers."

Before I left the shop I looked around again, this time more critically. I couldn't find any Rider Manuals or Photofact books or anything similar. There was no signal generator. All I saw was the collection of resistors and condensers, the tools, and the pocket-size volt-ohmmeter. I wish I had had the time to stay longer and see how quickly he could check an elaborate band-switching system or find a shorted turn in an i.f. transformer with only the volt-ohmmeter. But I had to go, and so I said good-bye. "I hope I've convinced you not to overcharge for small jobs," was his parting comment.

As I walked slowly down the street, I didn't notice the bright sunshine or the pleasant shade trees that lined the sidewalks on either side. I was puzzled!

Had I just spent a half hour with the biggest faker in radio? Or was he a brilliant and highly skilled practical technician? Should time charges be inflexible? Or was my system the better one?

What do you think?



Taxi driver in a now familiar pose.

Installing Two-Way Radio In Taxicabs

By SAMUEL FREEDMAN

TAXICABS now have more two-way radio installations than all the other mobile radio services combined. The Federal Communications Commission estimates that there are now about 2,000 taxicab radio systems. A rough estimate based on a number of systems picked at random indicates that there is an average of 21 taxicabs per system. This means that about half of America's 80,000 taxicabs are equipped or licensed for two-way radio. About 150 new systems per month are being licensed.

Equipment for taxis is now available from Bendix, Comco, Doolittle, Federal, General Electric, Harvey, Kaar, Link, Mobile Communications, Motorola, Philco, Raytheon, RCA, Temco, Western Electric, Wilcox Electric, and others. The entire field has developed since the war when the FCC in May, 1945, made

available two frequencies in the 152-162-mc band.

Except for a few modified surplus military sets, all taxicab equipment is FM. The operating frequency in the 152-162 megacycle band is reached with several frequency-multiplication stages stepping up the quartz crystal fundamental frequency from 32 to 96 times. Because taxicabs are primarily interested in coverage of their own city or community (usually less than 5 miles maximum distance in any single direction), most sets are of low or medium power. This has permitted the development of compact equipment in which the transmitter and receiver are in the same cabinet. Some manufacturers have designed equipment powered by a vibrator instead of having a separate dynamotor high-voltage supply for the transmitter.

The equipment is of three types:

1. *Single unit* with all the transmitting and receiving components mounted on a single chassis. The Bendix 2½-watt and Motorola 5-watt Dispatcher units are typical.

2. *Single housing* with two decks, one for the transmitter and the other for the receiver. The Federal 25-watt equipment is a typical example.

3. *Dual unit* with separate cabinets for the transmitter and the receiver. This requires two mounting plates and additional space. It is common with higher-powered equipment. The highest power used in the mobile units for the 152-162mc band is currently about 30 watts.

In the typical taxicab installation, the following will normally be found:

In the rear trunk: The transmitter and receiver as one or two units. Cables here run to the rooftop antenna, to the control unit in the driver's compartment, and to the storage battery, wherever it may be located (usually under the hood).

In the driver's compartment: The control unit, microphone, and loudspeaker. A control cable will run back to the transmitter-receiver in the rear trunk.

Under the hood: A two-wire power cable will run to the transmitter-receiver in the rear trunk. In some installations only one wire is used and the ground return circuit is through the car body.

On the roof: An antenna, either flexible, or rigid with a spring base, capable of withstanding collision with tree branches. For the taxicab frequencies this antenna is approximately 17½ inches long and is always vertical. It connects to the transmitter-receiver via a solid-dielectric flexible co-axial cable.

Installation pointers

Aside from the conditions specific to a particular piece of equipment, the following is considered good practice in installing equipment in taxicabs or similar vehicles.

1. The transmitter and receiver should be made inaccessible to unauthorized persons. This is done best by

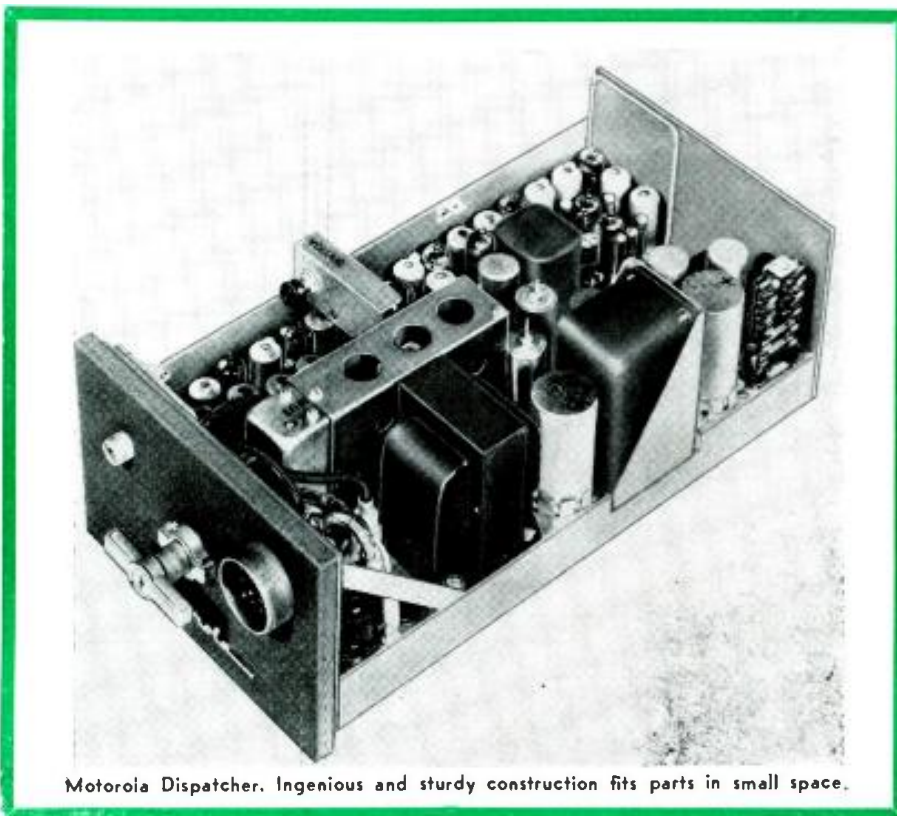

Motorola Dispatcher. Ingenious and sturdy construction fits parts in small space.

locating them in the locked rear trunk.

2. The control unit and microphone should be easy to reach and use by the driver of the taxicab. They are usually located at about the center of the instrument panel.

3. The equipment (transmitter, receiver, and power supply) should be easy to install, service, and remove without sacrificing too much space in the rear trunk.

4. The equipment in the rear trunk should be protected against any rain which might work inside along the seam between the rear trunk door and the car body. It should also be protected against loose tools, tire chains, luggage, or anything else bumping against it.

5. The equipment cabinet or cabinets should be electrically grounded to the car body. If the cabinet is screwed or bolted into the metal deck, this requirement is automatically taken care of. Otherwise a metal braid strap should be connected between the equipment cabinet and some metal part of the car body.

6. The equipment layout and holes should be planned and spotted carefully before they are made.

7. If there is any excess cable length, remember that the equipment may be used in new cars when the old ones are traded in, and the length requirement may be different. A cable that is too long can be still used; one that is too short cannot.

8. The spare tire must be accessible for removal or for checking its air pressure.

9. Every hole through which cable must pass may chafe or cut into the cable. Prevent this by using a rubber grommet, protecting the cable with several layers of insulating tape where it passes through the hole, or by doing both.

10. Every bolt without a lock-washer may be expected to work loose unless it corrodes badly and rusts solid.

11. In drilling bolt holes in the rear trunk to support the transmitter-receiver, make sure that the drill does not penetrate into the gasoline tank or into a heavy car frame member or some inaccessible point where it will not be possible to attach a bolt underneath for tightening.

12. Drill no holes in sheet metal (particularly on the finer exposed finishes of the vehicle) without first using a center punch. Otherwise, the electric drill will crawl and mar a large area.

13. The voltage drop between the storage battery and the equipment in the rear trunk should not exceed 0.5 volt. The battery cable should be kept as short as possible. It is good practice to cut it to the minimum possible length for a particular installation without regard for future installations. Usually the battery end of the cable will need replacement (because of corrosion) by the time the equipment is transferred to another vehicle. A new battery cable for each new installation is entirely reasonable.

14. Do not permit any cable to run

outside the vehicle, as underneath the car, where it will be exposed to mud, dust, and jars.

15. Mount equipment in the rear trunk to withstand severe shocks when the vehicle travels over uneven road surfaces at high speeds.

16. Place the microphone where it will not hit the face or body of the driver in the event of a collision.

17. Make the installation such that the value of the car will not be seriously lessened for trade-in because of the holes. The only visible hole should be that in the rooftop for the antenna. The antenna base insulator should be left on the car when it is traded in and a new one used for the next installation.

18. Install equipment so that it can be removed and replaced in the event of faulty behavior or transfer to another vehicle.

All items of equipment should be located for the shortest cable lengths consistent with accessibility for servicing and inspection.

The taxicab antenna

The single antenna must serve both for reception and transmission. This is made possible by the antenna transfer relay located in the transmitter. When the microphone push-to-talk button is pressed, the relay closes and connects the antenna to the transmitter. When the button is released, the relay opens and connects the antenna to the receiver.

The antennas used for the 152-162-mc band are either flexible, or else rigid with a flexible spring base, as shown in the photograph. The base of the rigid radiator connects through the insulator to the co-axial transmission line leading to the equipment with a flexible braided conductor.

Fig. 1 shows the details of a typical antenna installation. The procedure for such an installation is:

1. Measure the length of antenna cable from the bottom of the antenna base. Determine the location of the cross members near the center of the roof of the car; and, at a spot between members equidistant from each side of the car, drill a 3/8-inch hole. If a longitudinal channel is encountered and it cannot be penetrated through a hole in the channel, drill a hole through that also. Usually it is not necessary to cut or drop the upholstery. A good location

for the antenna base is directly over the center of the back rest of the front seat but clear of the dome light. The hole should be clean, with no burrs. Be careful to prevent the drill from slipping through and damaging the upholstery.

2. Feed the free end of the co-axial cable (without the fitting) from the antenna base through this hole.

3. Route the cable through holes in cross members of the roof. These holes may be located by feeling through the upholstery on the roof of the car. The cable is to be brought out into the trunk compartment near the equipment cabinet. In some cases, removal of the rear seat is helpful in routing the cable and fishing it through. All slack cable should be pulled through into the trunk compartment.

4. Loosen the bracket screw on the antenna base as much as is necessary



Federal units are drawer-mounted in cabinet.

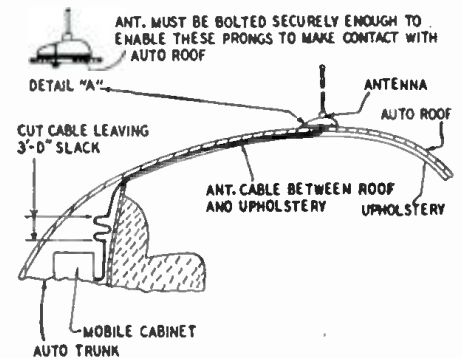

Fig. 1—How antenna is installed in car roof.



Raytheon transmitter-receiver (right) and control box (left) show compactness of equipment.

to slip the bracket through the hole in the roof of the car. A rubber washer must be under the head of the mounting screw. The pointed end of the antenna base should be toward the rear of the car. Tighten the mounting screw, making certain that the semicircular guide on the base fits into the hole and that the two metal grounding points project through the rubber gasket. This will insure proper grounding to the metal frame of the car when the mounting screw is securely tightened. The



Motorola control unit mounts under dashboard.

antenna whip is trimmed to the correct vertical length. For the 152-162-mc band, the correct lengths are:

Frequency (mc)	Length (inches)
152-155	17%
155-159	17%
159-162	17%

5. Insert the whip into the base insulator and secure with an Allen wrench. The lock-nut may be covered with Duco or Glyptal so it will not work loose.

6. Cut off any excess cable, allowing 3 feet more than necessary to reach the cabinet. Make a fitting to the cable for attachment to the equipment. Very poor range and signal strength can result if the shield of the co-axial cable floats at either end. The inner conductor must connect to the whip electrically at the rooftop and to the inner conductor of the co-axial fitting at the equipment. The outer conductor or sheath must be grounded at the rooftop and at the equipment cabinet. The writer has seen sets with a working range of less than 5 miles with a co-axial cable floating at one end, compared to a range of 40 miles as soon as this condition was corrected.

If the antenna is not located on the center of the roof, transmission will be directional. The best transmission and reception will take place in the direction in which most of the car metal is between the antenna and the other station. In the case of an antenna mounted on one corner of a vehicle, the difference in signal strength will be approximately 4 to 1 between the best direction and the worst direction for the same distance. One of the great advantages of taxicab radio operating on the 152-162-mc band is the feasibility of using the center of the roof, where this 4-to-1 characteristic has disappeared. Instead, the maximum characteristic is approximately present in every direction rather than only one as in the days of 30-40 mc when bumper antennas were employed.

General experience in the taxicab field has been that low power can be tolerated but a defective antenna system cannot. The maximum airline cov-

erage required in a typical city for taxicab operation seldom exceeds a working range of 5 miles.

To reduce interference to adjacent cities in urban areas, the FCC is currently considering plans to limit the antenna height and transmitter power of the dispatching station, as most of them have an excess coverage.

Some typical sets

The Bendix MRT-3A Communication Unit includes a 2½-watt FM transmitter, a 10-tube superheterodyne FM receiver, and a 6-volt vibrator power supply in one cabinet, which is mounted in the rear trunk. This cabinet measures 16½ x 8 x 3½ inches. The equipment requires a maximum of 16½ amperes from the 6-volt car storage battery during transmission. The entire installation is shown in Fig. 2.

There are three connecting cables. A co-axial cable connects the transmitter-receiver to the antenna. An eight-wire cable goes to the control unit in the driver's compartment. This unit contains an on-off switch and a volume control as well as the hand-set. A two-wire power cable connects to the storage battery. The live side goes through a protective fuse to the live lug of the car starter, making unnecessary a connection to the corrosive lug of the storage battery.

The principal unit is mounted flat across the back of the rear seat, at-

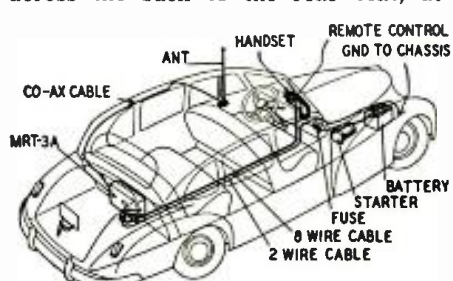

Fig. 2—Installation of components and leads.

tached to a pair of metal braces usually present behind the seat. If these braces are suitably spaced, they can be drilled for four 10-32 bolts on 5 x 12-inch centers to accommodate the predrilled mounting holes in the case. If braces cannot be used, a piece of plywood may be used to support the unit. Screws, nuts, and lock-washers should be used to prevent loosening due to vibration.

The Motorola Dispatcher is rated at 7 to 10 watts output. It draws a maximum of 21 amperes at 6 volts during transmission. The entire transmitter, receiver, and dual-vibrator power supply are mounted on a single chassis which mounts in the rear trunk. There are five different ways of mounting the cabinet. The control unit used in the driver's compartment has a volume control with four positions: OFF, LOW, MEDIUM, HIGH. It also has a variable squelch control to adjust sensitivity just above the local noise level. The range may be increased by adjusting the squelch control into the noise region, at a sacrifice in signal quality. A micro-

phone clip on the control unit serves as receptacle for a small microphone. If a handset is used, an additional holder accessory is provided. In the Motorola a single cable connects to the live battery terminal. The return battery circuit is through the grounded car body.

The Raytheon installation uses a transmitter-receiver unit and a smaller power supply and control unit with connecting microphone. This equipment is unique in that, by keeping the power supply in the driver's compartment, a shorter power cable may be run to the storage battery.

The Western Electric Type 238 is another common installation. The maximum load during transmission is 57 amperes. If considerable transmission must take place, it is advisable to equip the vehicle with an oversize generator. This is the same equipment as that designed for the Bell mobile radio service for common-carrier communication. It utilizes separate transmitter and receiver units in the rear trunk. It is also designed to function in connection with a selective dialing and ringing circuit.

The Federal 25-watt installation uses a single cabinet housing the transmitter and receiver. Either unit is removable merely by pressing the levers on each drawer handle. The unit may then be inspected, serviced, or exchanged. All connections are automatically made in the rear of the unit when the drawer is locked in position.

Installation time

The normal time for a complete taxicab installation is approximately half a working day for two men. Some economy in man-hours results when identical equipment is installed in many identical vehicles at the same time. Then more men may be used, with each specializing in certain operations. The vehicles should be placed alongside each other with one man drilling holes, another mounting units in the rear trunk while another works in the driver's compartment. If more men are available, another may be fishing and securing cables. In that manner, installation time may be reduced to about 2 hours, depending on the type of equipment and the type of vehicle which is being equipped.

Typical charge for an installation job is about \$20 for labor. Typical charge for servicing is \$5 per vehicle per month, under contract, with parts extra. Parts are usually charged for at either list or half-way between list and net. Prices vary greatly, depending on the distance the serviceman must travel, the number of vehicles involved, and to what extent his principal livelihood depends on this work. It also is dependent on the quality and complexity of the equipment and the care which the operating personnel give their equipment. The cost of parts varies from zero to several dollars in any one month, with the possibility of operating several months in a row with no expense whatever.

HOME-BUILT PHONO USES TWO PICKUPS

By HAROLD J. GOULD



Motorboard holds two pickups, one for good discs, one for bad.

A PHONOGRAPH comparable in results to the more expensive custom-built sets can be built according to the following specifications. The phonograph is equipped with two pickups, and the amplifier has two input stages. A high-quality pickup feeds one input and is used with good records; the other pickup is used for playing old or badly worn discs. The two input stages (see Fig. 1) are identical high-gain pentode amplifiers. The equalizer enclosed in the dashed box is the unit supplied with the Brush PL-20 pickup; the resistors and condensers for this are sealed in a metal can and are connected to terminal lugs. Be sure to use the Brush 3761-B equalizer. It is intended for high-impedance inputs. Others are supplied for low-impedance use.

The input stages are followed by a phase inverter using a triode-connected 6SJ7. This stage gives very little amplification but has low distortion and excellent frequency fidelity. The load resistance for the phase inverter consists of two 47,000-ohm resistors R14 and R15. Splitting the load in this way and grounding the center point supplies the grids of the power tubes with voltages approximately the same in amplitude, but differing in phase by 180 degrees. R14 and R15 should be as nearly equal as possible to obtain equal push-pull signals.

Used in the power amplifier stage are two 6B4-G tubes, biased for class-A operation. Other tubes, such as the 6A3 or 2A3, could be used in this stage; they have similar characteristics, but different heater requirements and bases. Class-A amplification, although not as efficient as the other classes, has much to recommend its use in a high-quality outfit. For one thing, 6B4-G's in class-A push-pull have very low distortion; and what distortion they do have is second harmonic, which cancels out in push-pull. Another advantage of using class-A triodes results from their low plate resistance. This plate resistance is effectively in parallel with the speaker voice coil and serves to damp the speaker. Without adequate damping, a sound impulse fed to the voice coil will not produce an exact replica of the original

impulse but may pass through several cycles before it eventually dies out. This is what causes the muddy effect in many amplifiers employing tubes whose plate resistance is too high, especially beam-power tubes.

There is absolutely no advantage in having a superb pickup and amplifier if the output transformer is a cheap, skimpy affair. This component can introduce distortion that will nullify the results of an otherwise high-fidelity system.

A cheap output transformer will handle its rated power all right; but the amount of iron in the core is usually too small for the flux density present, and third-harmonic distortion is introduced into the signal. Also, the transfer of power from the plates of the output tubes takes place less efficiently in a poorly designed transform-

er. The obvious solution is to use a good transformer, one with plenty of iron and copper in it. The output transformer could well be nearly as large as the power transformer. The writer was unable to obtain a high-quality transformer, but with a little extra work managed to contrive an admirable substitute.

The parts—chokes, transformers, fil-

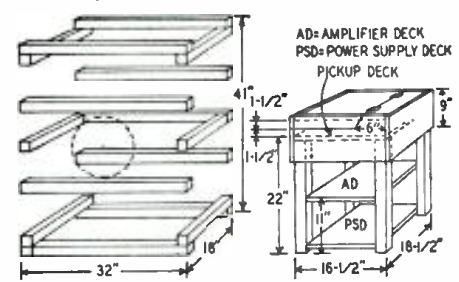
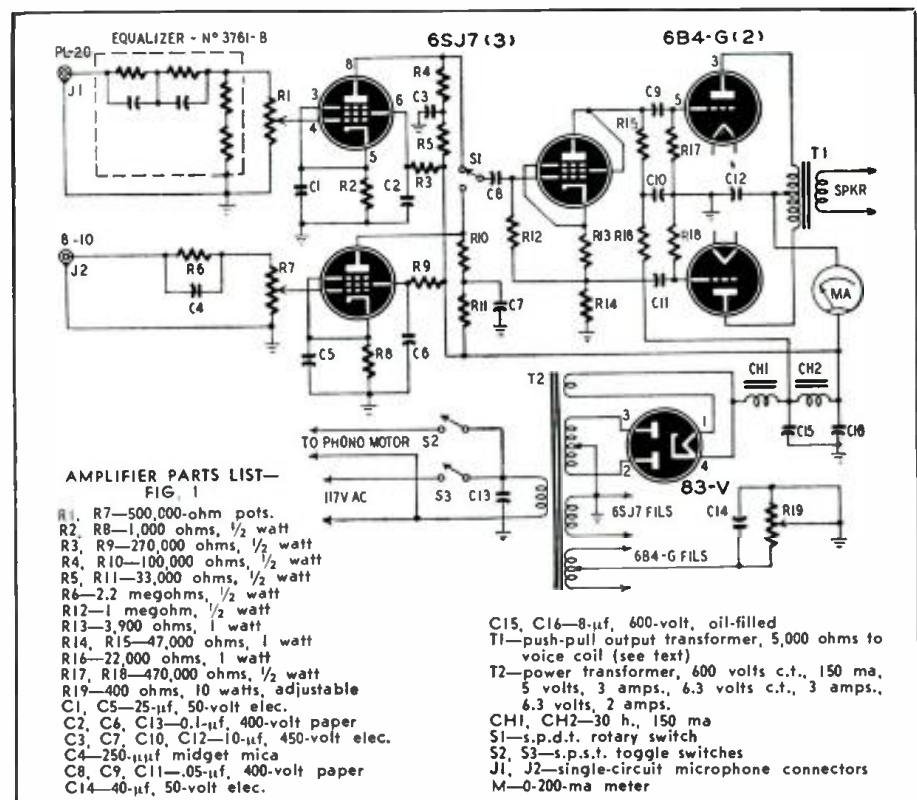

Fig. 2—Details of speaker cabinet and stand.



ter condensers—that were selected for the power supply were on the hefty side, allowing a generous margin for safety and making for trouble-free operation. R19, the 6B4-G biasing resistor, should be adjusted to give a 45-volt drop across it.

(The milliammeter in the power-stage plate circuit was apparently put



Fig. 3—Inside of speaker cabinet is padded.

there to indicate whether or not the stage was functioning. Other constructors might leave it out for economy's sake.—*Editor*)

The speaker chosen for the phonograph was a Jensen A12-PM. Although there are many units on the market utilizing woofer-tweeter combinations, this was judged to be the best compro-

mise between quality and economy. Heavy and solidly built, its power-handling ability is high enough. Any good speaker may, of course, be used.

A well-designed enclosure for the speaker is as important as a good speaker. If the enclosure is flimsy or undersized, the sound will lack deep bass and the high notes will sound strident. Also, there will be annoying rattles on loud passages.

The enclosure used satisfies all the requirements for high-quality, life-like reproduction. It consists of a ruggedly constructed wooden box, the dimensions of which are shown in Fig. 2. This size exceeds the requirements of a minimum inside volume of 15,000 cubic inches which is needed for a 12-inch speaker mounted on an infinite-type baffle. By the time the inside reinforcing members and absorbent lining are added, the spare space is used up. For strength and solidity 7/8-inch-thick wood is used in the construction of the box, with cross-members of 2 by 2. To lessen the possibility of boards' working loose in time, wood screws rather than nails are used to fasten the several sections together.

A removable back for the speaker box is constructed of the same heavy wood used for the walls. The 11-inch speaker opening is equipped with a hinged lid which can be lowered to protect the speaker cone against accidental injury. To aid in moving such a large and heavy speaker assembly, casters are fitted to the bottom of the cabinet. (A square of heavy metal screening placed

between the speaker and the hole would probably be a better way to protect the cone against injury.—*Editor*)

When the box is completed and the speaker mounted and wired, the enclosure and its back are lined with absorbent material to a thickness of approximately 1½ inches. Kimsul acoustical wadding may be used here. This material was unobtainable, however, and the writer made do with a quantity of cotton batts of the kind used to fill quilts and bedspreads. These served the purpose and were an inexpensive substitute for the regular sound-absorbent material. A glance at the photo will be sufficient to show how this lining is tacked inside the baffle. With the

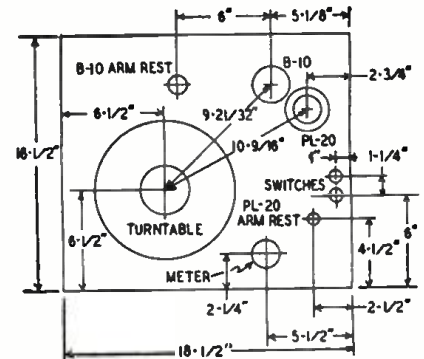

Fig. 4—The drawing shows motorboard layout.

lining in place, the back of the box should be screwed down securely using plenty of heavy wood screws.

Construction of the separate phonograph-amplifier assembly is shown in Figs. 3, 4, and 5.

This is a phonograph that will give its high-priced brother, the custom-built model, a run for its money as far as performance is concerned. And as for appearance, there is no reason why it cannot compete here, too. If the builder has any skill at all in cabinet making, or wishes to have the cabinet made to order by a cabinet maker, he will have a fine piece of furniture. The rough appearance of the model shown in the photographs was due partly to lack of skill at carpentry and partly to impatience with spending any undue time on the "mere appearance" of the equipment.

(Note: While many readers will not be impressed with the idea of using an extra pickup for the purpose of saving the "good" one, the two-pickup scheme could well be used to make the phonograph play the new Microgroove records as well as standard discs. Simply substitute a Microgroove pickup for the inexpensive crystal the author used. Of course, a two-speed turntable will be necessary, too. Both preamplifiers are not necessary—one of those now used may be abandoned by placing S1 ahead of the preamplifier and using it to switch pickups to the input of a single 6SJ7. If the PL-20 gives too much surface noise with poor records, build one of the simple step-type equalizers shown in the PL-20 bulletin, obtainable from the manufacturer.—*Editor*)

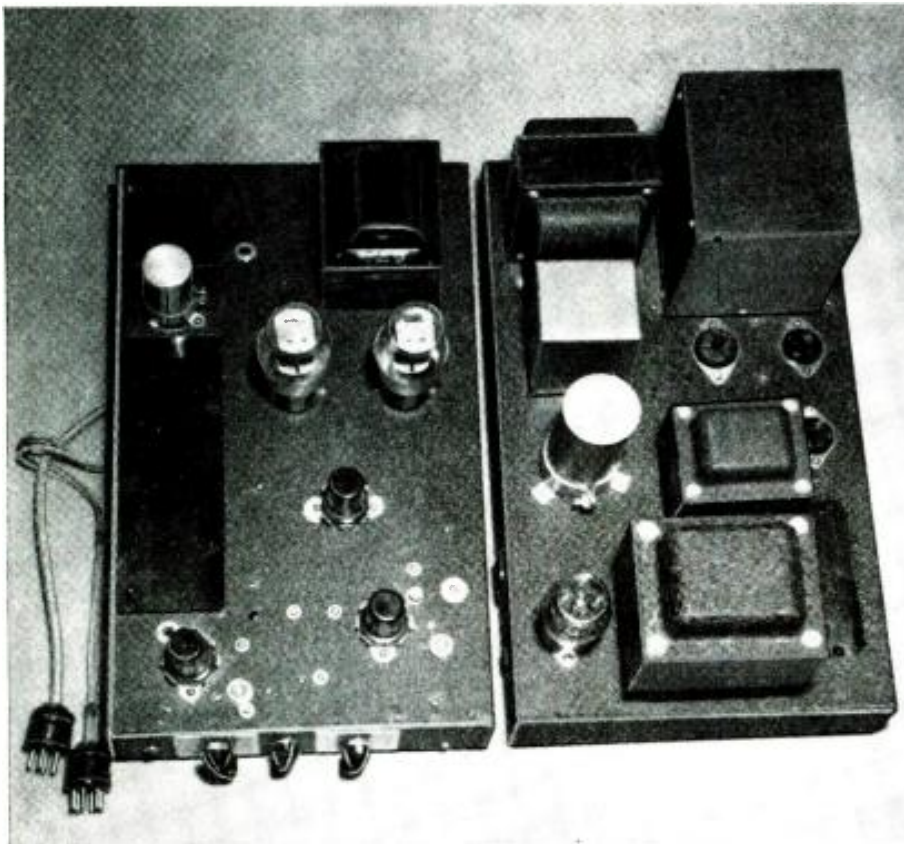
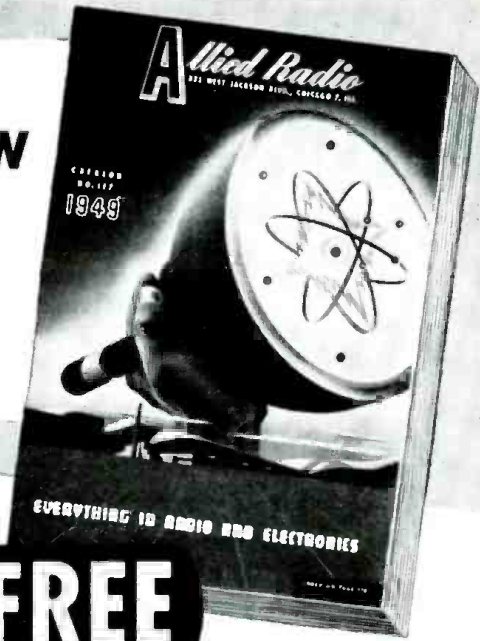

Fig. 5—Use of separate chassis for amplifier and power supply helps to reduce hum pickup.

Get Your ALLIED Catalog Now

180 Value-Packed Pages Featuring

Everything New in Radio!



FREE

Send for the ONE COMPLETE Radio Buying Guide!

Get the Radio Buying Guide that's used by thousands of expert servicemen, engineers, amateurs, soundmen, builders and experimenters. Get every buying advantage at ALLIED—widest selection of equipment at money-saving low prices—speedy, expert shipment—personal attention—complete satisfaction on every order. Get your ALLIED Catalog today!

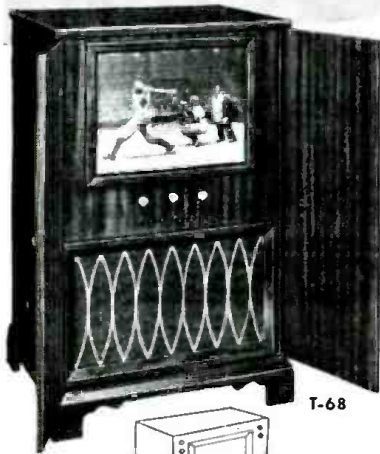

T-68

NEW! Projection Television by Hallicrafters—16" x 12" Screen

Amazing 192 Sq. Inch Picture!

Develops a brilliant, steady, optically correct picture; glare-free for comfortable viewing both at close range or distance, day or night. Optical system stays in perfect, stable adjustment. Includes following features: 2½" magnetic projection triode, sealed optical unit, 25 kv high voltage unit, 12 channel push-button selector, RF amplifier, 3 IF amplifiers, 2 video amplifiers, special synchronizing circuits, AGC and black level control, single picture control, inter-carrier FM system. Complete with 20 tubes, plus projection triode and 5 rectifiers. In handsome classic Chippendale mahogany cabinet. For 105-125 volts, 50-60 cycles AC.

- 97-805. Hallicrafters T-68 Projection TV in console. NET, f.o.b. Chicago **\$695**
- 97-801. Hallicrafters T-60 Projection TV in rack (less cabinet) for custom installation. NET, f.o.b. Chicago..... **\$595**

IMMEDIATE SHIPMENT FROM STOCK

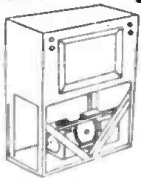

T-60



Hallicrafters 10" Direct View!

Here's an unbelievably sharp picture, with excellent stability and truly photographic contrast. Priced amazingly low for the quality. Features include: 12 channel push-button tuning, RF amplifier, 3 IF amplifiers, 2 video amplifiers, improved sync circuits, AGC, static-free FM. Complete with 19 tubes, plus 10" picture tube and 3 rectifiers. In rich mahogany table cabinet. For 105-125 volts, 50-60 cycles AC.

- 97-804. Hallicrafters T-67, 10" TV wood table model. NET, f.o.b. Chicago **\$295**
- 97-802. Hallicrafters T-61. As above, in black plastic cabinet. NET, f.o.b. Chicago **\$279.50**

Famous Hallicrafters 7" TV Receiver

An immensely popular TV receiver at low cost! Provides a brilliant 23 square-inch picture. Easy to operate; excellent sound; install it yourself.

- 97-803. Hallicrafters 505 in mahogany cabinet. NET, f.o.b. Chicago..... **\$199.50**
- 97-800. Hallicrafters T-54, as above, but in gray furniture-steel cabinet. NET, f.o.b. Chicago..... **\$189.50**

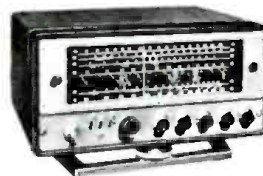

Short Wave Listeners! DX Fans! SX-62

HALLICRAFTERS' special SWL Receiver! Tuning range: 540 kc to 110 mc, continuous—world-wide Short Wave and special services; broadcast and all FM channels between 27 mc and 110 mc. Features: professional slide-rule dial; 500 kc crystal calibrator; single knob tuning, 60 to 1 ratio; bands illuminated separately; series type ANL; 4-position tone control; high-fidelity audio; 6-step filter; dual IF channels; crystal filter; 8 watts output, etc. In handsome steel cabinet. With tubes.

- 97-540. SX-62. NET, f.o.b. Chicago **\$269.50**
- 97-780. R-42 Speaker to match. NET .. **\$34.50**
- 97-568. B-42 Tilt-Base. NET **\$7.50**

Radio's Leading Buying Guide...



Everything in Radio and Electronics

★ ALLIED RADIO

- ALLIED RADIO CORP., Dept. 2-M-B
833 W. Jackson Blvd., Chicago 7, Illinois
- Send FREE 180-Page ALLIED Catalog
 - Enter order for Hallicrafters Model.....
 - Enclosed \$..... Full Payment
 - Part Payment (Bal. C.O.D.)
 - Send ALLIED Easy Payment Plan details and order blank.

Name.....

Address.....

City..... Zone..... State.....

Push-Button Generator



Sloping-panel cabinet is conveniently small.

Receivers can be aligned and tested more speedily and accurately with this crystal signal generator

By **ROBERT E. ALTOMARE**

RECEIVERS can be aligned faster and more accurately than usual with the aid of this crystal-controlled, push-button-tuned signal generator. Seven channels are used, but, by employing a switch with more buttons, the constructor can increase the

number of available frequencies. By a judicious choice of crystals, harmonics may be used and an instrument developed which covers an extremely wide range with comparatively few channels. The instrument also has separate audio output with very good wave form.

The audio can also be used to modulate the r.f.

A 6AU6 miniature pentode is employed as an electron-coupled Pierce oscillator. The screen grid acts as the oscillator anode. The Pierce circuit was chosen because it is simple and requires no adjustable tuned circuits.

The diagram shows the circuit. The crystals connect directly between the control grid and the screen. With too much r.f. excitation, the crystal may crack. Since r.f. excitation depends on the d.c. anode voltage, this must be kept fairly low. The 56,000-ohm dropping resistor may have to be increased to keep the screen down to about 60 volts. The 100-ohm cathode resistor aids in protecting the crystal in the event of an accidental overload. The 100,000-ohm grid resistor furnishes grid-leak bias. The 33- μ f capacitor determines the amount of feedback applied to the control grid; its value is not too critical.

Since a Pierce oscillator requires a capacitive anode circuit, the anode tank must be tuned to a frequency *below* that of the crystal. While maximum output will be obtained if this tank is tuned just below the crystal frequency, there will be enough output even if the tank is tuned far below it, provided the L-C ratio is high. This is why a tuning capacitor can often be omitted and only stray and coil capacitances utilized in its place. In this instrument the 2.5-mh and 1-mh chokes act as tuned anode circuits. The 5-45- μ f trimmer is inserted simply because various constructors will have their own ideas as to which crystal frequencies are most desirable. It, along with the stray and choke-coil capacitances, will resonate the choke anywhere between approximately 170

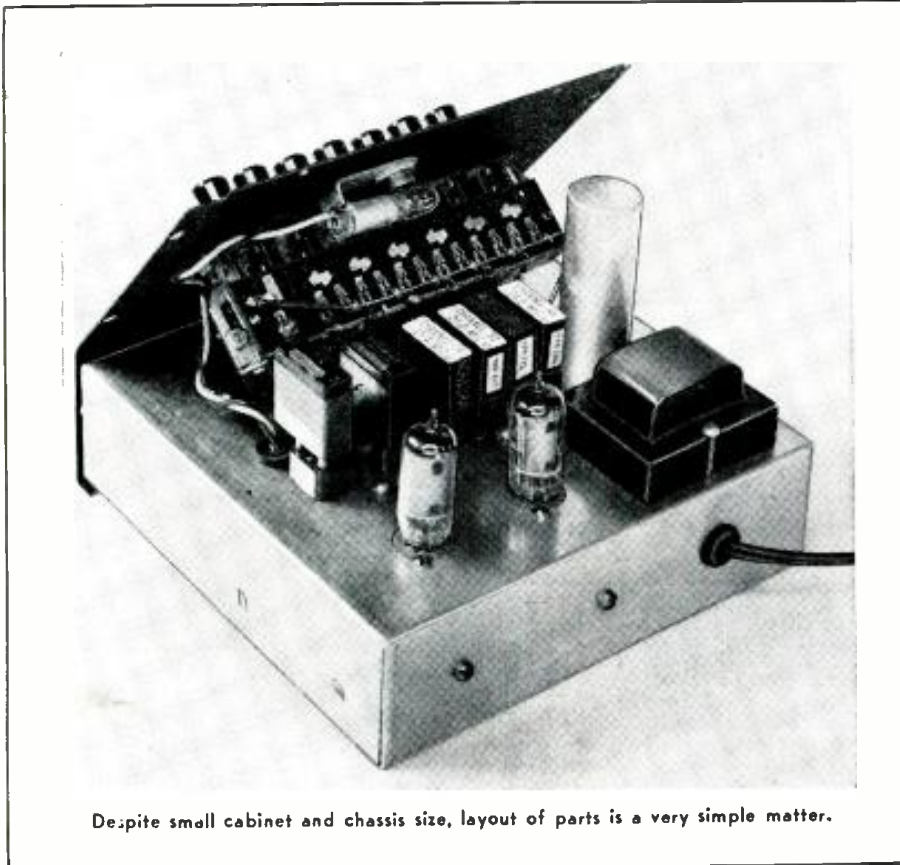

Despite small cabinet and chassis size, layout of parts is a very simple matter.

and 800 kc. The 1-mh choke will resonate somewhat below 1 mc (depending on the coil and the stray circuit capacitances). Crystals inserted in positions 5, 6, and 7 can therefore be 1 mc or higher.

Another 6AU6 is used as an audio oscillator; its output can be used to modulate the r.f. oscillator. A phase-shift circuit was chosen because it gives very low distortion, yet is extremely simple and compact, no transformers or inductances being necessary.

The audio gain control also determines the percentage modulation when the r.f. oscillator is being modulated. It actually varies the feedback necessary to sustain audio oscillation. The 82,000-ohm resistor in series with it provides a stopping point. Oscillations just begin when the potentiometer arm is set at the ground end. When it is at the plate end, sufficient audio output goes to the r.f. oscillator to modulate it approximately 100%. The suppressor of

The crystal-controlled signal generator will be most useful in aligning broadcast sets, of course. Harmonics of the 200-kc and 470-kc oscillators, as well as the fundamental of the 1,000-kc crystal, are essential for aligning the r.f. sections of broadcast sets. I.f.'s are taken care of by the 455-, 460-, and 470-kc crystals. And the 10.7-mc channel is suitable for FM i.f.'s.

Servicemen are not the only ones who will find the unit handy. Many ama-

teurs, for instance, have found that building a v.f.o. with the desired stability is not as easy as it sounds. For them, the push-button crystal selection scheme makes a large number of crystal frequencies available, especially if a larger push-button assembly is used.

The variety of harmonics available from the several crystals can be used to spot a large number of frequencies in the short-wave bands, useful for calibrating or band-locating.

FREQUENCY TABLE

Channel	Xtal freq.	Important harmonics
1	200 kc	600, 1,000 and 1,400 kc
2	455 kc	none
3	460 kc	none
4	470 kc	1,410 kc
5	1 mc	multiples of 1 mc
6	5 mc	multiples of 5 mc
7	10.7 mc	96.3, 107 mc

the r.f. oscillator tube is modulated so there is little interaction with the oscillator proper.

Crystal frequencies

The writer chose the frequencies listed in the table because these are probably the most useful ones for service work. The table shows the range possibilities with harmonics of the crystal frequencies chosen. (Another reason for using a Pierce oscillator was that its output is rich in harmonics.)

Economy is an important factor, too. For this reason, surplus crystals were used. For example, the 455-, 460- and 470-kc crystals are purchasable on the surplus market at attractively low prices. These crystals were employed in FM channels and, in order to obtain correct final frequencies after multiplication, it was necessary to employ fractional-kilocycle crystals. Thus, the 455-kc crystal actually oscillates at 455.556 kc. It might be thought that this makes for inaccuracy. Actually, the error is only 0.122%, a degree of accuracy normally unobtainable in a tunable signal generator even if it is "on the button" because of operating errors introduced by parallax and the width of the pointer.

This particular crystal is employed not only to align 455-kc i.f. amplifiers, but also for 456-kc i.f.'s. The error here is less than 0.1%.

Some other crystals available on the surplus market at reasonable prices include those with frequencies of 200, 1,000, 2,500, 3,500, 5,000, and 10,000 kc.

It might be a good idea to mount one crystal socket on the front panel so that unusual frequencies could be set up without opening the case.

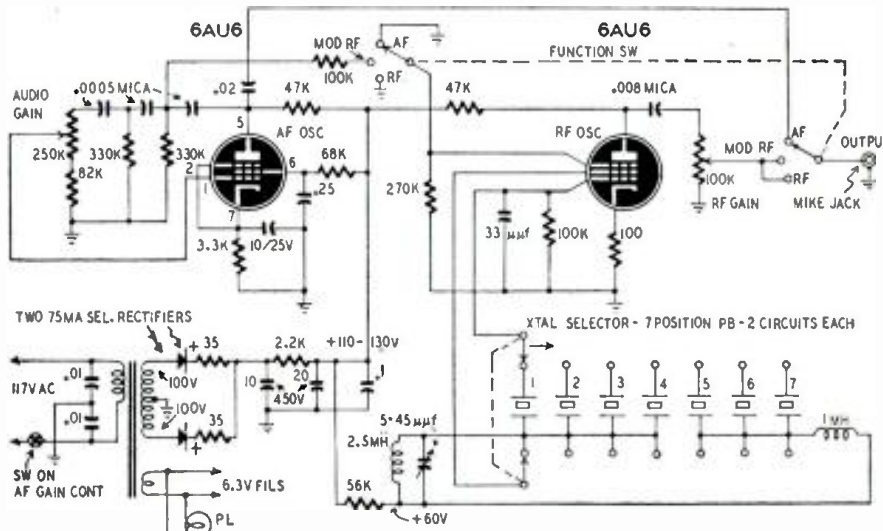

More crystal frequencies can be made available if a larger push-button assembly is employed.

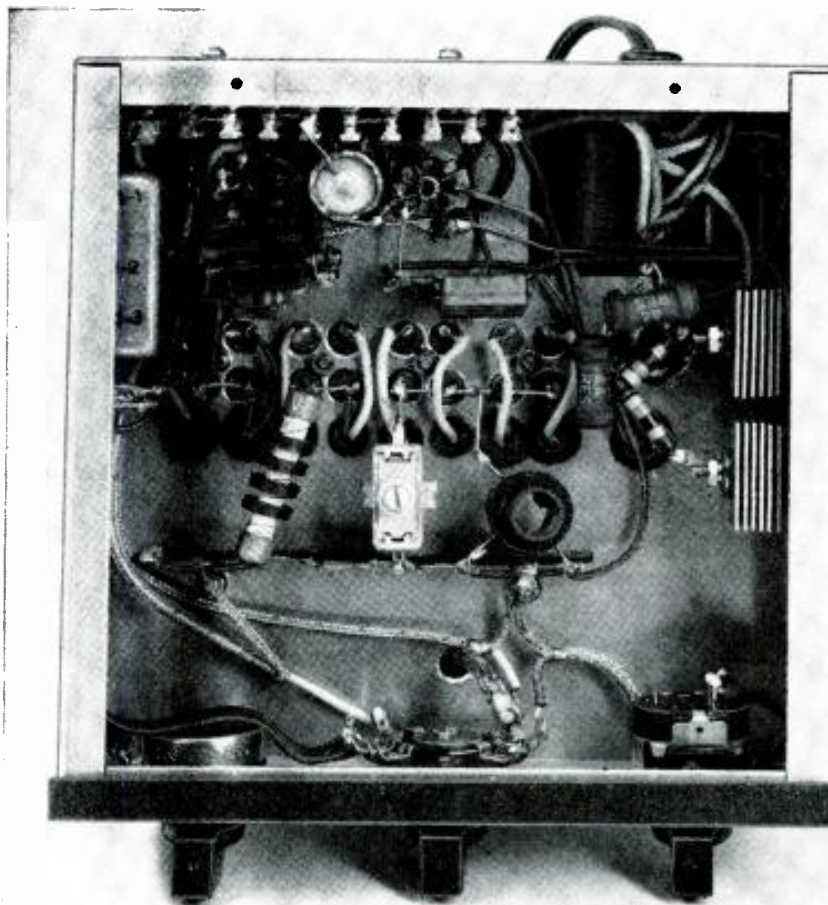

All the parts can be distributed neatly under the chassis leaving plenty of space to spare.

Substitution Unit-Plus

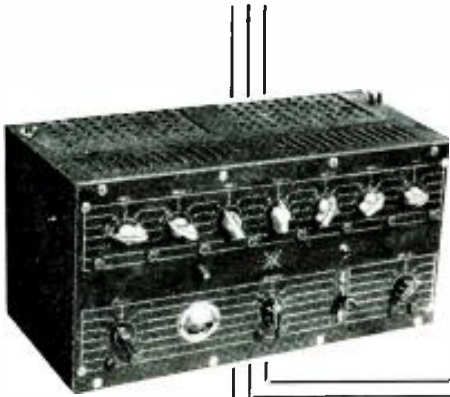

A capacitor test up to 800 volts is also supplied by the instrument

By G. N. CARTER

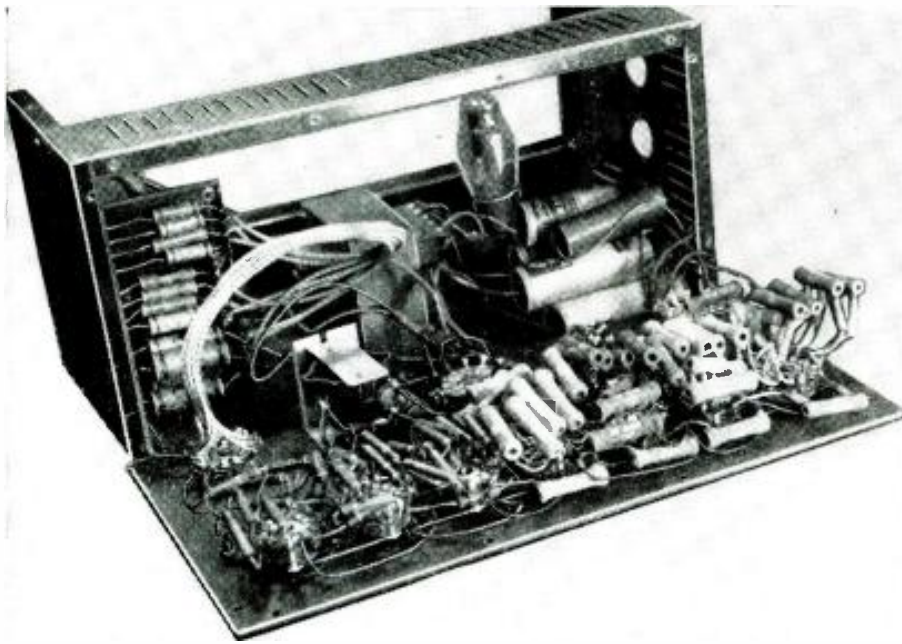

Inside and (above) front view. The resistors are mounted directly on the panel switches.

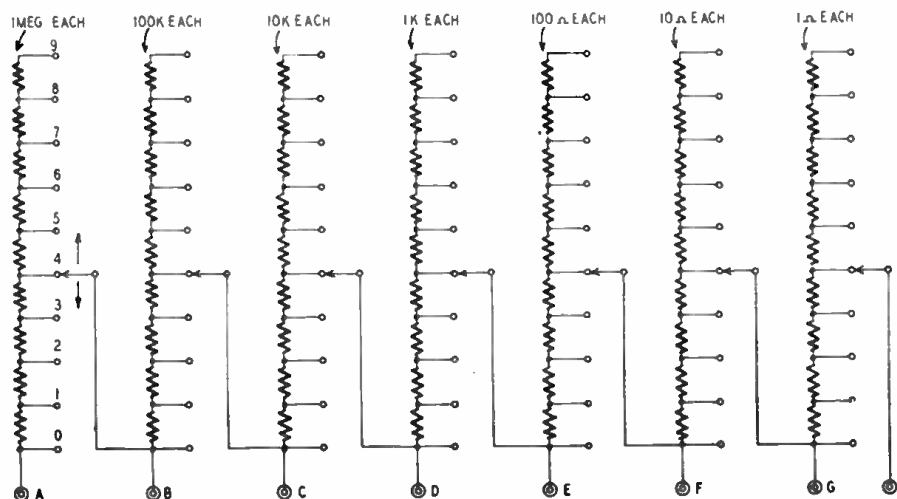

Fig. 1.—Any resistance from 1 to 9,999,999 ohms is available with a minimum of switching.

NEXT to the tube tester and the volt-ohmmeter this piece of equipment has been found to be the most useful in the shop. It can be employed on almost every service job because it deals with the two most frequently used components, condensers and resistors.

The unit actually does four separate jobs. First, it provides a resistor substitution unit giving any value between 1 and 9,999,999 ohms. Second, it furnishes a high-voltage test for condensers, with test voltages of 200, 400, 600, and 800. Third, it contains a paper condenser substitution unit with values of .005, .01, .02, .03, .04, .05, 0.1, 0.25, and 0.5 μ f. Last, an electrolytic condenser assembly gives values of 4, 8, 12, 16, 20, 30, and 40 μ f.

It was built as a substitution unit for service bench use, but a similar instrument made with precision resistors and accurately calibrated capacitors could well be used as a semi-laboratory instrument for comparison tests or in connection with a Wheatstone bridge. In that case, the electrolytic condensers would have to be checked regularly, as they cannot be depended on to maintain their capacitance.

The resistor unit shown in Fig. 1 is a modification of a decade resistor box. Any resistance value between 1 and 9,999,999 ohms may be obtained with the direct-reading scale. Each decade range is individually accessible by plugging into the correct pair of tip jacks. (This feature is especially valuable when employing values between 1 and 9 ohms. Jacks G and H can be used, eliminating the possible resistance of the switch contacts which would be in the circuit if the connections were made to jacks A and H and all switches but the last turned to zero.—*Editor*) Resistors of 5% tolerance were used, giving sufficient accuracy for most replacement work, as well as a saving in cost over those of better accuracy.

Shorting-type switches were used to minimize sparking and burning of the switch contacts when employed in current-carrying circuits. Note that in the zero position of the switches adjacent terminals are shorted, allowing a rapid selection of values without having to move the test leads from one jack to another. Say the test leads were plugged into jacks A and D to find some unknown value. If the 1-megohm resistors were too high in value, then the megohm switch would be turned to zero, effectively cutting out all those from the circuit and leaving the 100,000- and the 10,000-ohm resistors.

The only precaution to observe is that when the decade is across a high-voltage circuit, the switches in use should not all be turned to zero. If they are, the source will be shorted. Zero was purposely omitted from the front panel markings to prevent persons unfamiliar with the circuit from using that position and possibly causing trouble.

In the model, the four lowest ranges employed 10-watt resistors for greater power dissipation in case these ranges were to be used as bleeders or as dummy loads in checking audio power output of amplifiers.

The capacitor-substitution sections are shown in Fig. 2. In the one using paper capacitors (at left) the foil end of each capacitor should be connected to the common bus and to the ground terminal. In the electrolytic section (at right) capacitor polarities should be observed as shown. Although 450-volt electrolytics were used in the model, 600-volt units would be more useful and would be less likely to break down.

Capacitor tester

This portion of the instrument, diagrammed in Fig. 3, has several features worth noting. The first position of the rotary switch puts a 0.1- μ f condenser across the test terminals so that the operator can test the checker for correct operation. The other four positions supply 200, 400, 600, and 800 volts to the test jacks. To reduce shock hazard while using the voltage test, the a.c. switch is spring-returned to OFF, which means that both hands cannot accidentally be across the high voltage. This a.c. switch is ganged to a discharge switch which discharges the condenser under test through the 1-megohm resistor, producing a flash in the neon bulb. A pair of polarized leads with insulated tip plugs on one end and clips with rubber insulators on the other allows the test voltage to be applied to condensers and other components for test purposes. The spring-return switch used for charge-discharge and a.c. is a Centralab 457. (It might be more convenient to use an ordinary toggle for the a.c. on-off switch, retaining the spring-return unit for charge-discharge only. This would eliminate the necessity of waiting for the 83 to warm up each time a test is made when a number of capacitors are to be tested in one session. The safety of the spring-return feature is not too complete, since one hand could be touch-

ing the plus terminal while the other brushed against the metal panel while operating the switch. So be just as careful as usual when making capacitor tests.—Editor)

To test a condenser, clip the test leads from the test terminals across it, select the desired voltage with the rotary switch, and press the charge-discharge

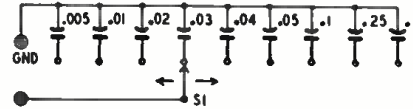

Fig. 2—Two rotary switches make available all values of paper and electrolytic capacitors.

switch to CHARGE. If the condenser has a value of .02 μ f or greater, the neon lamp will flash and go out, indicating a nonleaking condenser at that test voltage. When the switch returns to DISCHARGE, the condenser will discharge and flash the neon bulb again, indicating a good condenser and making it safe to handle, particularly if it is of high capacitance and was tested on 800 volts.

fer, the 9 x 17 1/2-inch front panel being replaced with a piece of black Masonite fastened to the frame with rack-panel-mounting screws. The surface of the Masonite was sanded lightly with fine sandpaper to remove the glaze and permit it to be easily marked with a white crayon pencil. If, just prior to marking, the surface is moistened with glass

cleaner, the pencil will write much more easily than if dry and the result will be almost the equal of a pen or a brush job. After the marking was completed, the panel was sprayed lightly with clear lacquer to prevent the white lines from getting smudged. White bar knobs were used for the resistance switches and red for the three lower ones which are for the condenser sub-

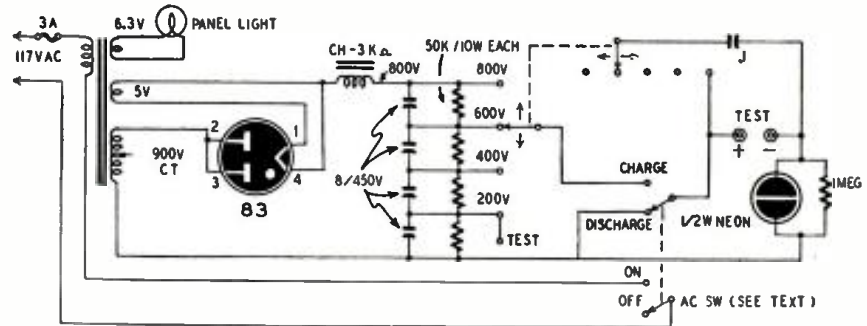

Fig. 3—Voltage supply. An old receiver pack may be adapted, as voltages are not critical.

To check the operation of the tester, switch to the TEST position. This will put the 0.1- μ f capacitor across the test terminals. Operation of the CHARGE-DISCHARGE switch in the usual way will show that the unit is working. If, some day, the test does not flash the lamp, don't start tearing the instrument apart. Try a new 0.1- μ f test capacitor first; the old one may have gone bad.

The outer case for the instrument was taken from a discarded PA ampli-

substitution units and the voltage test.

After giving this job a fair trial, the technician will never go back to the hit-or-miss method of bridging across suspected unit resistors or condensers picked up at random. Probes with alligator clips will reach into difficult places and make sure connections, then several values may be tried almost instantaneously.

This is the workmanshiplike way to substitute components.

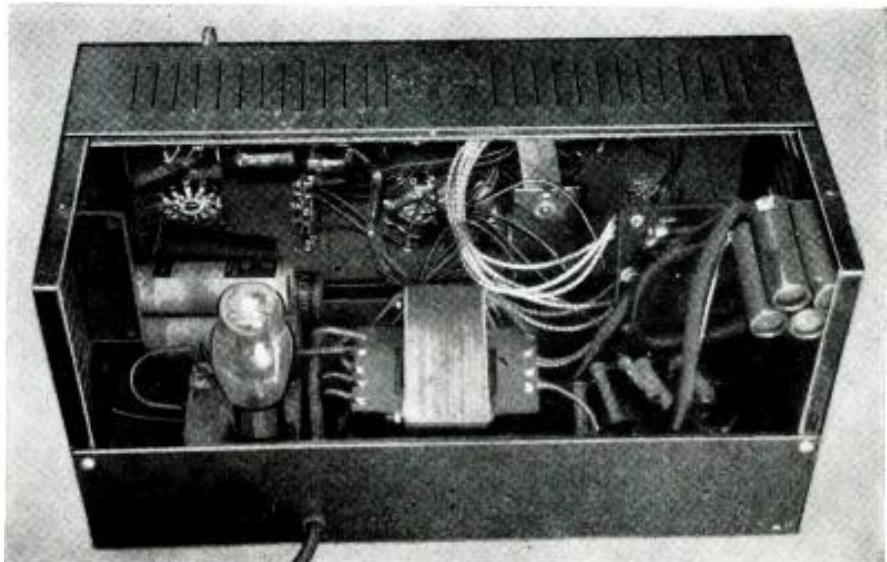

This rear view of the equipment reveals a few more details of mounting and parts layout.

European Report

By Major Ralph W. Hallows

RADIO-ELECTRONICS LONDON CORRESPONDENT



AN interesting new series of subminiature tubes has recently been brought out by Mullard Electronics. Designed for use in deaf-aid appliances, these tubes are of three types: DF70 is a pentode amplifier, DL71 and DL72 are output pentodes, intended for use with crystal insert and magnetic earphones respectively. The characteristic curves of DF70 are seen at right. An outstanding feature of these tubes is their minute filament current, which is but 25 milliamperes for all types. The drain on the A-battery of a 3-tube hearing aid is thus only 75 ma. The B-battery lead is 1.76 ma with 2 DF70s and 1 DL71, or 2.45 ma when the DL72 is used in the output stage. It is not so many years since the old Audion required 750 ma at 4 volts, or 3 whole watts of A current to heat its filament—and now the DL70 rubs along quite contentedly with one tenth as much filament current at less than one sixth the voltage, consuming no more than 0.0468 watt! I needn't say what a boon these low-current tubes are to users of hearing aids, particularly when their filament current is supplied by the Vidor mercury cell which I described recently. One of these cells will supply the filaments of a 3-tube hearing aid for 30 hours *continuously* without any falling off in performance.

Hail Columbium!

A remarkable new magnetic alloy, developed here by the Permanent Magnet Association in collaboration with the Electrical and Allied Industries Research Association, has just been announced. In this case the "little something that the others haven't got" is a tiny quantity of the scarce metal which we call Niobium and you Columbium—anyhow it's Element No. 41. The make-up of the alloy is:

Cobalt	21
Nickel	11
Aluminum	8
Copper	4
Columbium	56
Iron	
	100

The exact percentage of Columbium

has not been divulged, but it is believed to be very small. Queer, by the way, that that table should contain yet another metal for which we have a different name. We call it aluminium, (pronounced "al-you-minnie-um"). You will see that the new alloy is more of an iron than a steel, for it contains no carbon at all. Further, except for the columbium, it is made up of the same ingredients as Alnico, though they are not quite in the same proportions. The new alloy, which doesn't yet appear to have been given a name, is superior to any other now known in its coercivity. In other words, it is much less easily demagnetized. It is the latest addition to the largish family of cobalt-nickel-aluminum-iron alloys and the history of its gradual development goes back quite a few years. Two alloys very like it, but without the Columbium, were produced during the war for use in radar equipment. Then came another, containing vanadium, which was designed not for magnetic purposes but for use in jet propulsion engines. This proved to have unexpected magnetic qualities and gave birth to the idea that even better results might occur if Columbium, which is in the same group as vanadium in the periodic table of the elements, were used instead.

Birmingham television

There is considerable disappointment that the official date for the opening of the TV transmitter at Sutton Coldfield, near Birmingham, should be as far ahead as the fall of next year. In fact I wouldn't be surprised if popular clamor led to a speed-up. This station will be a good deal more powerful than the one in London. The exact figures haven't been announced, but I gather that they're something like 50 kw for vision and 10-15 kw for speech. It is to work on 61.75 mc and 58.25 mc for vision and sound respectively. This is just about as far as the band of frequencies allotted to television allows it to be from the London transmissions.

I don't quite know why such a wide separation has been decided on—it can hardly be from fear of mutual interference, since the London frequencies are 45 and 41.5 mc. Certainly it's causing a bit of heart-burning amongst those—and there are quite a few of them—living outside the normal London service area, though well within that of the Birmingham station, who have already invested in televisers. By using "add-on" rf amplifying stages and efficient antennas they have been able to bring in the London transmissions pretty well. But the snag is that their sets won't tune to the frequencies of the new station. It's preset tuning of course in

televisers; but it seems to me that the range should be adequate in any mass-produced receiver to allow at least the whole 40-60 mc band to be covered.

A.c.-d.c. Television

Though the manufacturers don't call them a.c.-d.c. sets, the new Pye B18T televisers which have just appeared here will work quite satisfactorily from 200-240-volt d.c. mains. These sets represent a big step forward, for by doing away with the need for a mains transformer they show how to make a surprising reduction in price.

This Pye set, for instance, with a 7½ x 6 inch image and a 19-tube circuit, sells at the equivalent of about \$175 in table model form. Nor is the

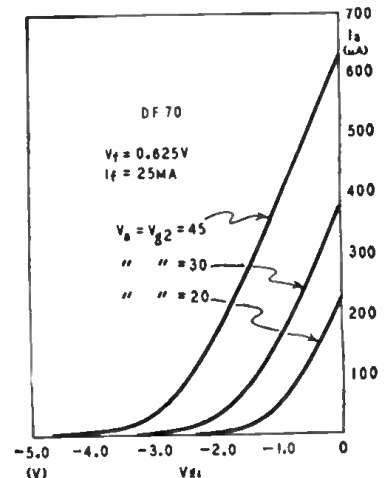

Curves of DF70 anode current vs grid voltage.

price the only thing that has been reduced: the set weighs only 30 pounds and its size is 17 x 12½ x 12¾ inches overall. The whole thing is a neat affair, incorporating some neat and ingenious ideas. The heaters of the tubes, for instance (including that of the cathode-ray tube) are series connected. Focussing is done by means of a permanent magnet. Not only does it need no current, but as there is no temperature drift, the control becomes one of the pre-sets and doesn't appear on the panel.

V. h. t. ("very high tension," or high voltage for the C-R tube) comes from the fly-back like this: the line-scan time base is a blocking oscillator feeding a pentode, whose output goes by way of a transformer to the deflector coils. The primary is made to form a step-up auto-transformer, which boosts up the fly-back voltage and passes it on *via* a single-diode rectifier to the v. h. t. line. (See "Kickback Power Supply" RADIO-CRAFT, January, 1948).

There are just three visible control knobs on the set: on-off switch, sound

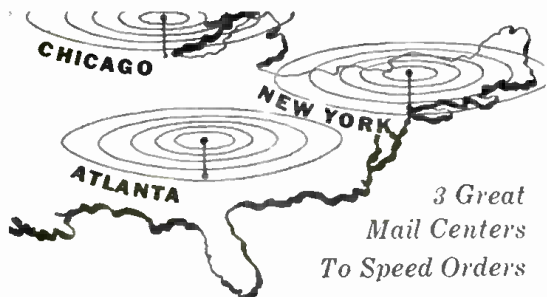

3 Great
Mail Centers
To Speed Orders

LAFAYETTE-CONCORD

ELECTRO NEWS

29 Years of Service—500,000 Satisfied Customers

TV, FM, LP "IN THE BAG" SAYS CLAUS!

New radio-electronic developments high on gift lists this year, W2 Xmas chief reveals, in exclusive interview.

BARGAIN BAZAAR

If you can use a little extra do-re-mi, check the prices below carefully. You can save more than just a few pennies, for each one of these items is a very special value. Quantities are limited so rush your order today.

COMPLETE ENTERTAINMENT CENTER

with wire recorder & playback
10 watt

P.A. system



new and exclusive

It's the most versatile all-around unit ever designed for home, professional and business use. It makes high-fidelity wire recordings from microphone, from radio, from record player. These compact wire spools can be played back thousands of times, or they can be instantly "erased" to be used over and over again! You can "monitor" and control volume while you're recording, like a professional. And presto, change-o! Mount the speaker into the detachable cover; you have a hi-fidelity speaker-baffle unit. In a matter of several seconds, you can convert it into a powerful 10 watt P.A. System.

A combination like this would ordinarily cost you well over \$300. But you can now buy it for only \$159.50, because Lafayette designed it and built it themselves.

DOZENS OF USES

Compact! You can carry it to parties, family gatherings, meetings! So inexpensive, nearly every home or office can afford one! Such high fidelity that even the most critical music lover will want it. 35N22559R.....

\$159.50

Howard FM tuner—For concert-quality FM recordings. 30N22492R (Mahogany). Designed to fit directly into entertainment center case..... \$32.63
Record spools: 35N16311R. 15 min. cap. 1.50
35N16312R. 30 minute capacity..... 2.25
35N16313R. 60 minute capacity..... 3.75

NEW POCKET RADIO SPLENDID VALUE



Slips into coat pocket—just enough extends to tune. Built-in antenna, self-contained flashlight cells. Good vol. on local stations. Covers broadcast band with additional range. Uses 2-154 mini tubes in standard regenerative-detector circuit transformer coupled to AF output stage. Case easily made. Less tubes, batteries, headset. No. 32N24516R—shpg. wt. 5 lbs. **\$5.85**

8" PM SPEAKER—21 oz.

MAGNET

High quality PM speaker at a money saving low price. Excellent replacement unit for hi-fidelity radios and P.A. systems. 21 ounce magnet handles 10-12 watt output. Voice coil impedance 8 ohms. No. 99N7018R—Shpg. wt. 4 lbs. **\$3.95**
No. 99N7019R—10" PM Speaker.. \$3.45 ea.

SPECIAL PRE-AMP KIT



For use with G. E. Pickup

Build your own pre-amplifier kit for use with the new G.E. variable reluctance or Pickering Pickup cartridges. Finished model is as fine as bass and treble compensated pre-amplifier as any available. Plate and filament power are received from associated receiver or amplifier. Complete with chassis, resistors, condensers, G5C7 tube, full instructions. No. 32N24536R—Wt. 2 lbs. **\$3.95**

ished model is as fine as bass and treble compensated pre-amplifier as any available. Plate and filament power are received from associated receiver or amplifier. Complete with chassis, resistors, condensers, G5C7 tube, full instructions. No. 32N24536R—Wt. 2 lbs. **\$3.95**

BEST BUY IN TV LENS

Now you can enlarge your television picture as much as 3 times original size! New strap-mounting plastic magnifying lens fits any model, requires no special installation. Enlarges 7" screens to size given by 10" tube, 10" screens to size given by 12" tube. No. 31N24477R—for 7" tube..... **\$10.95**



No. 31N24478R—for 10" tube..... **\$13.50**

REDUCED PRICE ON THIS AUTOMATIC RECORD CHANGER

only **\$16.95**



Improved, automatic record changer. Jam proof and child proof—tone arm can be moved at any time without jamming unit or changing adjustments. Plays records manually or automatically. Plays ten 12" or twelve 10" records at one setting. Single control for simple operation. Lightweight crystal tone arm assures hi-fidelity. Constant-speed 110 V., 60 C., AC motor. Dimensions—11 1/2" x 13 3/4". Requires 6" above and 2" below panel board. No. 99N9593R—12 lbs. Only... **\$16.95**

EVERYBODY WANTS IT ALL-STEEL MULTI DRAWER

BUILDS INTO
FILE
CABINETS



THEY HOOK
TOGETHER ON
ALL SIDES

Convenient storage for small parts. Each unit constructed with tongue and slot designed to interlock with other units at top, bottom or side. Units may be fitted and securely locked around existing fixtures for economy of space. Each drawer has handy pull and holder for contents card. All-steel. 2 3/4" x 2 3/4" x 5". No. 18N22381R—Wt. 10 oz.—10 for **\$360**

TV PROGRESS REPORT

Washington: Recent FCC ruling which halts consideration of 302 TV applications, for six months at least was prompted by the desire to improve service of present stations. It has been found that stations in adjacent cities operating on the same channel, or even on nearby channels have been interfering with each other. Wayne Coy, FCC chairman says that in no event will the usefulness of TV sets now on the market or in private ownership be impaired. The 37 TV stations now on the air, and the 86 in various stages of construction are not affected by the ruling.

TV is racing ahead and the FCC feels that it is better to check and make revisions now, in allocations, etc., than later on. The industry is in agreement with Chairman Coy when he says: "Our belief is that television is going to be a terrific service." If you want to take a quick glance at some of the best values in TV, get the Lafayette Concord Bulletin on TV... it's ready now.



A DIFFERENT
GIFT!

BED LAMP.

Here's a Christmas gift that shows imagination and good sense too! It's a beautifully-designed Bed Lamp & Radio combination. Enables her to read under light that's kind to her eyes—while she listens to her favorite band. Superb circuit. Built-in "air-magnet." Complete broadcast band coverage. AC or DC. Lamp has frosted lens for glareless light. Lamp and radio operate separately or together, as desired. Streamlined walnut bakelite. Brackets fit any type of bed. It's a \$29.95 value. No. 1-533R. Shpg. wt. 9 lbs. **\$21.95**

Television sets, FM receivers and tuners and the new Long Playing record players are in for a heavy play this Christmas, according to advance info from the North country. This seems to be in line with the growing emphasis on practical, useful gifts. You don't have to be run over by Santa's sled to know that it's extra smart these days to buy where your buck looks and acts bigger. So just in case you're a skeptic, match Lafayette-Concord values against others... you'll see why Santa has set up shop here.

GIVE YOURSELF THIS VALUABLE XMAS GIFT it's FREE!

If you could talk to the hundreds of thousands of Lafayette-Concord catalog shoppers, you'd soon find out why this is the bible of the industry. First of all, prices on the average are lower. Secondly, stocks are complete—don't forget L-C is the largest parts organization in the world. Then there are the thousands of odds and ends, the parts and tools you need and want fast.



SO GET YOUR COPY BY RUSHING THE COUPON

Lafayette-Concord has issued millions of copies of catalogs during the past 29 years. None have been so exciting. Television, High Fidelity, LP, FM, Public Address, Ham Gear, Test Equipment... you name it—and dollars to doughnuts you'll find more of it in this big book than anywhere else. All you need do is clip the coupon below and shoot it back to us on a penny postal. We've a hunch you'll count this new Lafayette-Concord catalog among your most worthwhile gifts this Xmas.

ATTENTION EXPORTERS

Orders from our many friends outside of the U. S. will get even faster handling if they are addressed to the Export Division.

ORDERING

Many of our friends shop in the famous L-C outlets listed below. If you are anywhere in the neighborhood, drop around. We are never too busy to say hello. MAIL ORDERS P. Post rates are kept to a minimum because your order is sent from the warehouse nearest you... another L-C money saving service.

SHOP IN ANY ONE OF OUR OUTLETS:

NEW YORK
100 Sixth Avenue
542 E. 14th Street, N.Y.C.
CHICAGO
901 W. Jackson Blvd.
229 W. Madison St.

ATLANTA
265 Peachtree St.

HOUSTON
110 Federal St.

NEWARK
24 Central Ave.

LAFAYETTE-CONCORD Dept. J1-8
901 W. Jackson Blvd., Chicago 7
100 Sixth Avenue, New York 13
265 Peachtree Street, Atlanta 3

MAIL NOW!

Please fill the following order:

- No. 35N22559R @ \$159.50
- No. 30N22492R @ 32.63
- No. 35N16311R @ 1.50
- No. 35N16312R @ 2.25
- No. 35N16313R @ 3.75
- No. 32N24516R @ 5.85
- No. 99N7018R @ 3.95
- No. 99N7019R @ 3.45
- No. 32N24536R @ 3.95
- No. 31N24477R @ 10.95
- No. 31N24478R @ 13.50
- No. 99N9593R @ 16.95
- No. 18N22381R @ 3.60
- No. 1-533R @ 21.95

Please rush FREE catalog No. 89.

Please send FREE Xmas Gift Catalog.

Please send FREE Television Bulletin

I enclose \$..... in postal note, money order or check. Will remit few cents postage when order is received.

Name.....
Address.....
City..... Zone..... State.....

LAFAYETTE-CONCORD

world's largest radio supply organization

volume and picture brightness. And, once the set has been properly installed, and the pre-sets correctly adjusted, these are the only ones needed.

This is a real pioneer amongst television receivers. I don't think it will be long before the set advertised as an a.c.-d.c. model makes its appearance. That will be progress indeed.

Better listening

At the moment the radio industry is conducting a "better listening" propaganda campaign. The object is to convince the owner of an aged receiver that his set is out of date and can't give him what's going from the broadcasting stations. Actually, there must be at least four or five million receivers still in use here which have been working for ten years or even more. During the war almost no new sets were marketed and people became accustomed to making do with their old ones. The habit has stuck and there's no denying that many listeners are putting up with shockingly bad reproduction. Servicemen tell me that they have receivers in for repair in which the only parts not worn out are the knobs.

One very clever advertisement is being run by the Ekco company in the trade papers. The illustration shows an ancient, bearded Dutchman, with eyes fast shut and the headphones of an antediluvian crystal set clamped to his

ears. The accompanying slogan is "Winkling out the Rip van listener". I expect the Rip van listener isn't unknown in the U. S. A. either!

One thing that is keeping back sales here is the purchase tax of 33 1/3% on radios. Salesmen have to break down not only sales resistance but tax resistance. I know quite a few folk who could well afford new equipment, but just won't buy it on account of that tax. Come to that, I hope no reader will ask the age of the broadcast receiver in my own home!

Star radio

The story of the tracking down of the sources of certain once mysterious radio noises (described in the March, 1948, issue of this magazine) is a fine example of the international cooperation of science. It began in 1933, when K. J. Jansky of the Bell Laboratories determined the source of the noise as the Milky Way. But the Milky Way covers a pretty big amount of space and more exact location was wanted. In 1946 J. S. Hey, working near London, found that radiation came from an active area not more than two degrees in diameter in the constellation Cygnus.

In July of this year J. G. Bolton of the Australian Council for Scientific Research narrowed down the Cygnus area to 8 seconds of arc; and now M. Ryle and F. G. Smith of the Caven-

dish Laboratory at Cambridge, working on 80 mc and observing the interference between signals from two directional antennas 500 meters apart, have measured the size of the source with still greater accuracy.

They find that the radiation comes in "bursts" of 20 seconds duration. This means that the source has a probable diameter no greater than the distance which radio waves can travel in 20 seconds: $186,000 \times 20 = 3,720,000$, or say $3\frac{3}{4}$ million miles. The diameter of the sun is 800,000 miles. There must be in the constellation of Cygnus some great body, of more than four times the sun's diameter, which is continually sending out these pulses of radiation.

Lately, at least six other sources of u.h.f. radio noise have been pinpointed. The work is going forward in many parts of the world and it may well lead to fundamental discoveries about the nature of radiation from our own sun and from other suns far out in space. It's an extraordinary thought that we don't know and never can know what's going on in any star *now*. So far away are those in the Milky Way that some of the "plocks" in the telephone receivers or the "blips" on C. R. T. traces that we hear or see are due to upheavals that actually occurred long before the earliest of our ancestors ceased gibbering in the tree-tops and decided to walk the earth on their two hind legs!

New Telephone Recorder

A ROBOT telephone secretary which can be adapted to any business or home, made its debut in Switzerland this summer before going into mass production in the United States and Great Britain.

This robot, a combination telephone and phonograph for taking messages in the subscriber's absence, is the creation of Willi Mueller, whose earlier invention of the Ipsophon had already commanded recognition.

That pioneer apparatus is now succeeded by a far more compact and less expensive instrument, the Notaphon. It uses an entirely new recording system which eliminates the use of magnetized wire and the attendant drawback of rewinding for the playback. Recording on the Notaphon is effected by means

of a disc similar to a phonograph record; but, unlike the latter, it is not cut but merely magnetized when a recording is made.

The Notaphon may be connected to any standard telephone instrument without altering or interfering with the latter's mechanism.

When a call comes through and the telephone receiver is not removed after three rings—perhaps either because the subscriber is absent or because he wishes to remain undisturbed—the Notaphon automatically goes into action.

It first announces the subscriber's name and address, and then requests the caller to speak. If he does not do so within eight seconds, the request is repeated, if he still does not speak, he hears "Notaphon ringing off."

As soon as the caller utters a sound, the recording mechanism starts to function. A silence of eight seconds automatically cuts it out. The whole arrangement is simple and foolproof.

One of several novel features of the Notaphon is a vocal secret code, preset by the subscriber, which enables him alone to play back the messages recorded on the disc. By dialing his own number from any telephone, waiting for the Notaphon's request to speak, and then pronouncing the vowel sounds forming his secret code, he sets the reproduction mechanism into motion. Five thousand possible code variations insure complete secrecy.

When the subscriber, who is perhaps spending the night out of town, has dialed his number, given the code correctly, and been told by the Notaphon that he is now connected, the playback of the day's "bag" starts at once.

On completing the playback, the robot requests its master to erase the recording. This is done by pronouncing another predetermined vowel sound. Deletion is verbally confirmed by the Notaphon, which now regains its full half-hour capacity. If deletion is not desired, the recording of later calls on the disc starts where previous recording stopped. When the instrument's capacity is exhausted, the robot voice informs subsequent callers of the fact.



Look for the distributor
who displays this sign!



AS a part of its 1948 program, Sylvania Electric will supply each of its authorized distributors with this new decal, printed in red, yellow, black and three shades of green. It's worth your while to look for this sign on

his windows, doors and trucks — it is your assurance that this distributor will supply you with genuine Sylvania radio tubes and top-quality test equipment — and that you can count on prompt, courteous service as well!

Sylvania Electric Products Inc., Radio Tube Division, Emporium, Pa.

SYLVANIA  ELECTRIC

MAKERS OF RADIO TUBES: CATHODE RAY TUBES: ELECTRONIC DEVICES: FLUORESCENT LAMPS, FIXTURES, WIRING DEVICES: ELECTRIC LIGHT BULBS

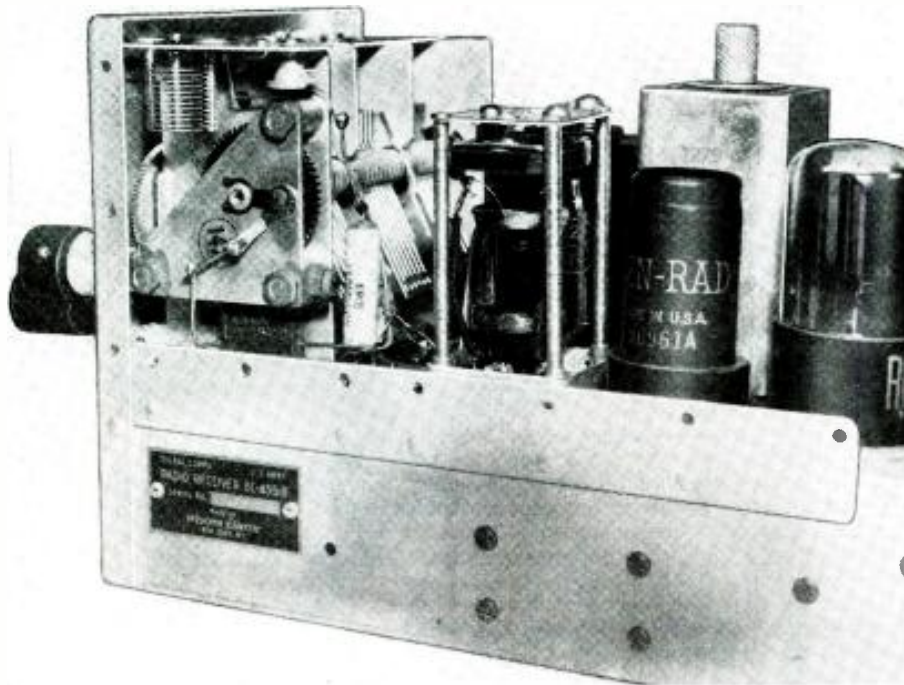

A side-on view of the BC-455-B, which is one of the well-known command group of receivers.

More Selectivity For the BC-455-B

AMONG the slickest radio receivers on the surplus market are those from the command set, the BC-453, 454, and 455.

When converted to available current sources, they leave little to be desired.

However, the 455-B, covering the 6-9-mc range, differs from the other receivers in that it employs no i.f. transformers, as such. Instead, each i.f. can contains a single plate tank, condenser-coupled to the following stage, while the coil which would serve as secondary in a conventional i.f. stage is untuned. This second coil merely acts as an r.f. choke in the following grid circuit.

For this reason, and because the i.f. is 2830 kc, the 455-B, while sensitive, tunes too broadly for crowded bands. The inherent selectivity of the set is only 9.8 kc two times down or 24.2 kc ten times down.

Fortunately, this lack of sharpness is easily remedied. The lower the intermediate frequency, the greater the selectivity and gain, up to the point where the image ratio becomes troublesome. All that is necessary to make the 455-B razor-sharp is to substitute conventional 456-kc. intermediate-frequency transformers.

The change-over is simplified by the construction of the i.f. stages already in the set. Each i.f. can contains four metal pillars, one at each corner, attached to the plug-in base. These pillars support a mica plate on which the variable condenser is mounted. The "works" of a standard 456-kc i.f. transformer (in this case a Meissner 16-6658) fit snugly inside these supporting pillars, and can be suspended from a plastic or metal plate attached to the top of the pillars with the original screws. Here are the steps:

Each of the three plug-in i.f. coils is secured to the chassis by two screws. Remove these screws and lift out the cans. Remove the four small screws holding the shield can to the plug-in base, and pull off the can. Remove the four screws holding the mica plate to the supporting pillars. Remove the screw in the center of the plug-in base which holds the coil form to the base. Cut the wires soldered to the plug-in socket terminals. The coil form, mica plate, and condensers may now be lifted out, and the unit is ready for installation of the 456-kc coils.

Remove the coil and condenser assembly from a 456-kc i.f. transformer. Drill and tap holes for 6-32 screws,

through the two bosses of the plastic plate supporting the trimmer condensers, and attach the entire unit to the new top plate. Then screw the plate to the four supporting pillars of the plug-in unit and solder the four leads to the proper socket terminals, as shown in the drawing.

Drill two 1/4-inch holes in the top of the shield can to permit tuning the new transformers.

The next step is to line up the new i.f.'s with a signal generator. Clip the generator's output lead to the top grid connection of the 12K8 and adjust the trimmers for peak output. Because the shield cans in the set are somewhat larger than those from which the 456-kc coils were removed, the effective inductance of the coils is altered slightly and it may not be possible to set the coils at 456 kc. The writer found that 498 kc fell in about the middle of the trimmer's range.

The oscillator coil is originally set to track with the antenna coil with a 240- μ f fixed padder shunted across a 40- μ f variable condenser. Changing the i.f. naturally calls for new tracking arrangements. This is not difficult because the antenna and r.f. coils already are tracked to the dial, and it is necessary only to make the oscillator coil track with these circuits.

The plug-in oscillator coil, as supplied with the set, contains 17 turns of wire in 1/2 inch of space on a form 11/16 inch in diameter. It is tuned by a powdered-iron core, which is preset and anchored in position. Remove the coil from its shield by unscrewing the four small screws which fasten the plug-in unit to the shield can. The coil then drops out, attached to its plug-in base.

Break the seal on the powdered-iron core, and screw the core down as far as it will go. Then either add four turns of wire to the coil, bringing the total to 21 turns, or remove the entire winding and rewind the coil to have a total of 21 turns. The winding is easy, since the coil form is threaded. No. 24 enameled wire makes a nice fit in the

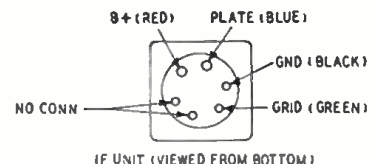

Bottom of the i.f. unit showing color codes.

threads. Unscrew the core 10 1/2 turns, and replace the coil in its shield.

Now solder a 500- μ f silvered-mica condenser in shunt with the button-shaped 240- μ f padder next to the 40- μ f variable padder on the frame of the main gang condenser. To do this, it is necessary to remove the aluminum shield enclosing the main condenser.

Fit the 500- μ f condenser snugly in the space below the reduction-gear mechanism, as shown in the photograph, so that it will not be in the way when the shield is replaced.

Feed a 6100-kc modulated signal into the antenna terminal of the set. Set the dial to 6100 kc and adjust the variable padder until the signal is loudest. While doing this, rock the dial a little to find the point of peak response. Since the antenna and r.f. circuits already are tuned to a gnat's eyelash, only a very slight rocking should be necessary.

If it is impossible, by varying the padder condenser, to bring the signal in at exactly 6100 kc on the dial, adjust the iron core in the oscillator coil half a turn at a time until the signal can be brought in precisely.

Now set the dial at 8900 kc and feed an 8900-kc modulated signal into the set. Adjust the oscillator trimmer condenser for peak response. Go back to the low end and readjust the padder, repeating both operations until good tracking is obtained from one end of the dial to the other.

If you find that the trimmer adjustment makes it impossible for the padder to correct the low end or that adjustment of the padder throws the high end beyond the range of the trimmer, you can get the inductance approximately correct by the following method:

Set the dial to 7500 kc and feed a signal of that frequency into the set. Set the padder condenser at about half capacitance, and adjust the oscillator inductance with the iron core until the signal comes in. Next turn to the high end and trim, and then to the low end and pad.

It is best to complete the preliminary tracking before replacing the aluminum shield on the gang condenser because the oscillator section of the gang condenser has two trimmers, only one of which, C-4E, can be adjusted with the shield in place. The other, C-4G, which is near the front of the set and normally is hidden by the shield, is set at maximum capacitance at the factory. It may be necessary to adjust this trimmer, as well as C-4E, to bring the oscillator into line at the high end.

It is convenient, while tracking the receiver, to remove all the coil shield cans from the metal plate to which they are riveted by drilling out the rivets. A 1/4-inch hole then may be bored in the center of the oscillator coil shield can, so that a small screw driver or tuning tool can be used to adjust the iron core. Later the cans may be re-attached to their supporting plate with 2-52 screws in the corners.

To complete the conversion, change the frequency of the b.f.o. from 2830 kc to the new i.f. This may be done by adding either inductance or capacitance to the b.f.o. unit until the required frequency is obtained. Or buy a 456-kc beat-frequency oscillator unit and substitute its coils for those in the set.

When the tuning is complete, a strong signal 10 kc away from the dial setting will be inaudible.

3 BASIC TYPES REPLACE OVER 150 STANDARD MODELS

Revolutionary Discovery
Simplifies Replacement—
Greatly Improves
Record Playing



REPLACEMENT FOR

ELECTRO-VOICE	ASTATIC	SHURE	WEBSTER	RCA			
MODEL M12 Medium Voltage (Red)	L-22A	L-76S	P30	P93C	E4	N4	31050*
	L-25A	L-76AS	P30B	P93D	E4-1	N6	31156*
	L-26A	LT-M	P30C	P93E	E-9	N6P	32632*
	L-27A	LT-MA	P30D	P93S	F1	N6P-4	33122*
	L-32A	LT1-M	P30E	P94	F1P	N8	33217*
	L-70	LT1-MA	P30S	P94B	F2	N8P	33905*
	L-70A	LT2-M	P87	P94E	F2P	N9	34225*
	L-70A	LT2-MA	P87B	W42A	F3P	N11	34307*
	L-70S	LT2-MA	P87S	W57A	F4P	N11P	34710*
	L-70AS	1-J	P90B	W57AN	F5		35171*
	L-71	1-M	P90C	W58A	F5P		37158*
	L-71A	401-A	P90D	W60A	F6		39686*
	L-71S		P90S	W60B	F6P		
L-71AS		P93	W60HS	N2			
L-76		P93B	W61B	N3			
L-76A							
MODEL H12 High Voltage (Blue)	L-24A	L-72S	P88	W56A	C-21		CR1A
	L-36A	L-72AS	P88S	W59A	C-31		CR2A
	L-46A	L-82	P89	99-180	C-61		52
	L-50A	L-82A	P89S	99-181	N-10		
	L-72	L-82V	W40A	W41A	N-10P		
L-72A	M-23			N-10P-1			
MODEL L12 Low Voltage (Yellow)	L-40A	LP-6	QC	QT-3JA	C51		71173
	L-41A	LP-21	QT-J	QT-3M	F3		70339
	L-75	LP-23	QT-M	QT-3MA	F7P		70338
	L-75A	MLP-1	QT-2J		N3		
	L-75S	MLP-1J	QT-2M		N5		
L-75AS	MLP-2	QT-3J		N7			

New Torque Drive Crystal Pickup Cartridge achieves clean, clear tone definition and fidelity that are truly amazing! You can hear the difference! Gives new life to every record library.

AUTHORIZED DISTRIBUTORS EVERYWHERE

Write for Replacement Chart Bulletin No. 146

New Model L-14 Microgroove Crystal Cartridge, and New Model 20 Magnetic Cartridge for Regulator or Microgroove records also available.

Use "A" mounting plate furnished with cartridges (1/2" hole centers) for all replacements except those marked with an * or †. *Use "B" mounting plate furnished (3/8" to 13/16" hole centers). †Use "C" mounting plate furnished (Webster Side Flange). All Model 12 Cartridges equivalent to ASTATIC "A" type except Tone Arm Rest Button is not supplied. It is recommended that the lower voltage cartridge consistent with volume level be installed. NOTE: Models M12, H12 and L12 have Osmium-tip Needle. For Cartridge with Sapphire-tip Needle, specify Model M12-S, H12-S, or L12-S.

E-V Pat. Pend. Licensed under Brush Patents

ELECTRO-VOICE, INC.
BUCHANAN, MICH.
Export: 13 East 40th St., New York 16,
U.S.A. Cables: Arlab



Phase-Modulated Exciter

By RUFUS P. TURNER



Front view of the phase-modulated exciter. The signal of a low-frequency crystal is multiplied eight times to hit 80 meters.

AMATEUR NBFM rigs generally sound good only so long as the carrier is not swung too much by the variations in voice intensity. This is especially true when the receiver is a conventional AM superheterodyne. Some fellows get so enthusiastic describing their new NBFM transmitters that they unintentionally shout into the microphone and knock the carrier all over the place. We decided, therefore, to include some sort of automatic level control in the audio channel of our NBFM exciter. Speech clipping won out over automatic modulation control because the clipper's action is instantaneous; a.m.c. takes a short time to catch up with unwanted voice peaks and does not "let go" immediately.

For a satisfactory design, we borrowed the basic essentials of the phase modulation exciter described some time ago by Sterman¹ and the speech clipper used in the Collins 30K transmitter². Modifications were made in a few portions of each circuit, either to permit use of easily obtained components or to adapt the exciter more efficiently to 75-

meter operation from a low-frequency crystal.

The block diagram in Fig. 1 shows the basic arrangement of the radio and audio channels of the exciter. The amount of equivalent frequency modulation obtained by phase modulating a crystal oscillator amounts to only a few hundred cycles. The desired narrow-band swing of 2 or 3 kc must be obtained by frequency multiplication.

A frequency-multiplication factor of 8 usually is satisfactory. To use this factor, it is necessary to operate the crystal oscillator between 481.25 and 487.5 kc in order to obtain output in the 3850-3900-kc NBFM section of the 75-meter phone band. However, it is desirable to keep the carrier at least 3 kc inside of each edge of the NBFM section to prevent out-of-band operation during frequency modulation. This means that the center frequency must be kept within the limits of 3847 and 3897 kc. The crystal frequency, accordingly, must be between 481.625 and 487.125 kc. (See the oscillator block in Fig. 1.)

The oscillator-modulator is followed by a doubler and a quadrupler, which provide the necessary frequency multiplication. The 75-meter output of the exciter may be link-coupled to a high-

gain buffer in any conventional 80-meter c.w. transmitter having a plate power input up to 1 kilowatt. In many transmitters, the FM exciter output may be fed directly into the grid circuit of the existing crystal oscillator (without its crystal) either with or without a link-coupled grid tank at the transmitter end.

The audio channel of the exciter includes a standard speech clipper which effectively knocks the peaks off all audio signals which rise above a level determined by the setting of the clipper control and keeps the carrier swing within controlled limits.

The unit is operated on voltages taken from a small power supply in the main transmitter. However, an individual builder, if he desires, may include the power supply on the exciter chassis for completely packaged construction.

When the exciter was first laid out, we were worried by the possibility of beat-note interference with nearby broadcast reception, since the crystal oscillator is operated on the nearest subharmonics of the broadcast band and the doubler is operated right inside the broadcast band. But tests have shown that no interference is caused in a broadcast receiver in the same house, provided the tank circuits are completely shielded (as shown in the photograph), the power-supply cable and r.f. output cable are shielded and grounded at each end, and the exciter chassis is grounded solidly to earth.

The low-frequency crystal required in this exciter may arouse some curiosity. We took a few "wipes" off a regular 456-kc receiver i.f. crystal to bring it up to 485 kc (exciter output 3880 kc). But crystal grinding is unnecessary, since government surplus crystals for frequencies between 400 and 500 kc may be bought, mounted in standard holders, for about a half dollar each.

The complete circuit

Fig. 2 is a complete schematic diagram of the exciter.

One triode of the 6SL7-GT acts as a low-frequency Pierce oscillator, while the second triode section is the phase modulator. The tank circuit L1-C5 in the plate circuit of the phase modulator is tuned to the crystal frequency.

The phase modulator is capacitance-coupled to the 6V6-GT/G frequency doubler. The doubler, in turn, is capacitance-coupled to the quadrupler. The quadrupler output tank is link-coupled to the co-axial output jack J1.

The three tank circuits L1-C5, L2-C10, and L3-C15 are shunt-fed. The .01- μ f isolating capacitors C6, C11, and

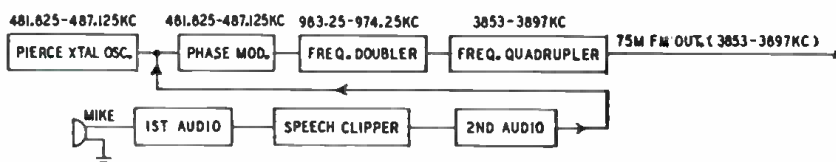

Fig. 1—Block diagram of the exciter. A reactance tube shifts the phase of the oscillator.

¹"Narrow-Band Phase Modulation Exciter," by Sol Sterman; *Radio News*, May, 1947.

²"Let's Not Overmodulate . . .," by Smith & Hale; *QST*, Nov., 1946.

C16 remove all d.c. from the tuning capacitor rotors, permitting these capacitors to be fastened directly to the shield cans without insulating washers. Once set for any crystal within the range, the tank circuits do not require retuning when crystals are changed.

A 0-1 d.c. milliammeter M is employed for tuning. The two-pole, four-position rotary selector switch SW connects this meter, with the proper polarity, across shunt resistors R8, R10, R12, and R14. In position 1, doubler grid current is read (this reading is a sensitive tuning indicator for the preceding tank circuit L1-C5). In position 2, the meter indicates doubler plate current. In position 3, quadrupler grid current is read. And in position 4, the meter shows quadrupler plate current.

With the shunts given, the meter has approximately the following current ranges: (1) 0-11 ma, (2) 0-50 ma, (3)

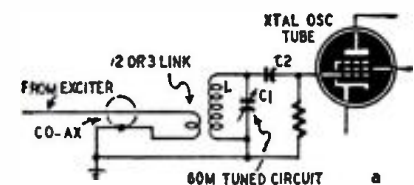

Fig. 3-a—This circuit can cause parasitics.

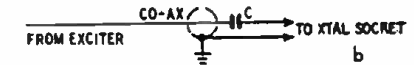

Fig. 3-b—For use with high-gain oscillators.

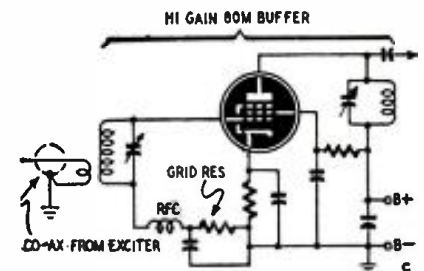

Fig. 3-c—The exciter works into a buffer.

0-11 ma, (4) 0-50 ma. Note that R10 is so connected that the milliammeter reads only plate current—not the total of plate and screen currents. This may well be done with R14.

The audio channel is a conventional high-gain amplifier with the addition of a speech clipper. The low-pass clipper filter is CH and C22, C23, and C24. R18 sets the clipping level, while R27

is the gain control. Audio output voltage from the 6SF5 is delivered to the phase-modulator section of the 6SL7-GT through coupling capacitor C27.

Power-supply requirements are 300 volts d.c. at 150 ma, well filtered, and 6.3 volts a.c. at 3 amperes. The B-plus line must be bypassed to chassis with a .005- μ f mica capacitor inside the power-supply unit, and both sides of the incoming 115-volt power line must be bypassed to the power supply chassis with 0.1- μ f capacitors. The power-supply chassis must be grounded solidly to earth.

Construction

The photograph shows how the 7 x 15 x 3-inch chassis is laid out. Shielding may be completed by slipping an amplifier foundation metal cover over the top of the chassis.

The tank-circuit aluminum shield cans were originally in an old-time broadcast receiver. A hole for the threaded bushing of the tuning capacitor is drilled through the top of each can. This grounds the rotors. The coils are held to the capacitors with stiff bus wire. L1 may be mounted by its own pigtailed. The isolating capacitors C6, C11, and C16 are placed inside the shield cans. Leads from the completely wired tank circuits pass (i.f. transformer fashion) through a grommet-lined chassis hole under the center of each shield can.

R27 is mounted through the top of the chassis; and its sawed-off shaft is slotted for screwdriver adjustment, since it ordinarily will not have to be touched after it has been set.

The power-supply cable must be shielded and the shield braid connected to chassis at both ends. The r.f. output cable from J1 likewise must be shielded and must be connected to chassis at both exciter and transmitter ends.

All wiring must be short, direct, and as free as possible from movement. Liberal use of insulated terminal strips as circuit tie points is recommended.

If the power supply is built on the exciter chassis, the clipper choke CH must be located and oriented with respect to the power transformer and power-supply filter so that it will not pick up hum.

Adjustment

After the wiring has been inspected and found correct, the exciter is ready for adjustment. Here are the necessary steps:

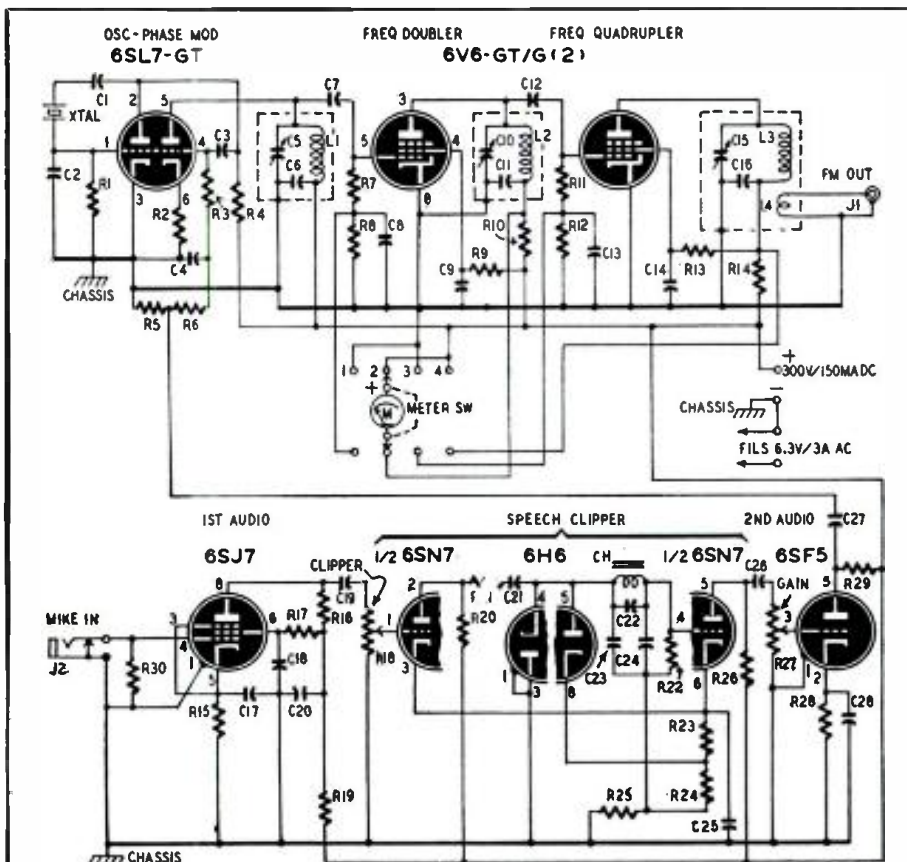

Fig. 2—Diagram of the 80-meter exciter. A low-pass filter follows the speech clipper.

- R1, R5, R20, R21, R22, R26, R29—100,000 ohms, 1/2 watt
- R2—33,000 ohms, 1/2 watt
- R3, R4—47,000 ohms, 1/2 watt
- R6, R16—270,000 ohms, 1/2 watt
- R7, R11—100,000 ohms, 1 watt
- R8, R12—10 ohms, 1 watt
- R9, R13—22,000 ohms, 2 watts
- R10, R14—2 ohms, 2 watts
- R15—1,500 ohms, 1/2 watt
- R17—1.5 megohms, 1/2 watt
- R18, R27—500,000-ohm potentiometer
- R19—10,000 ohms, 1/2 watt
- R23—330 ohms, 1/2 watt
- R24, R25—620 ohms, 1/2 watt
- R28—2,700 ohms, 1/2 watt
- R30—470,000 ohms, 1/2 watt
- C1, C4, C9, C14—.005- μ f mica
- C2—250- μ f mica
- C3, C7—.002- μ f mica
- C5, C10, C15—100- μ f midget variable (Hammarlund HF-100)
- C6, C11, C16, C19, C21, C26, C27—.01- μ f mica

- C8, C12, C13—100 μ f mica
- C17—25- μ f, 25-volt electrolytic
- C18—0.1- μ f, 400-volt paper
- C20—8- μ f, 450-volt electrolytic
- C22—180- μ f mica
- C23, C24—200- μ f mica
- C25—20- μ f, 25-volt electrolytic
- C28—10- μ f, 25-volt electrolytic
- CH—3.5-h, 50-ma choke
- J1—female chassis-mounting co-axial receptacle
- J2—closed-circuit phone jack
- L1—2.5-mh, pie-wound r.f. choke
- L2—0.5-mh, lattice-wound r.f. choke
- L3—36 turns No. 28 enameled wire, close-wound on 1-inch-diameter polystyrene form
- L4—3 turns No. 24 d.c.c. wire, close-wound on same form as L3 and separated 1/8 inch from B-plus end of L3
- M—0-1-ma meter (with internal resistance of approx. 100 ohms)
- SW—double-pole, 4-position, nonshorting rotary switch
- XTAL—481.625- to 487.125 kc crystal (see text)

TRANSVISION



NEW Television Kits, and Equipment

Important Advances in TV Reception and Servicing!

NEW 10" TV KIT at amazingly LOW PRICE!



MODEL 10A TV KIT

The new Transvision Model 10A electromagnetic TV Kit gives a bright, stable 52 sq. in. picture. Has 10" picture tube, and **CONTINUOUS TUNING** on all 12 channels. Its high sensitivity makes for improved long-distance reception; especially good on high channels. Complete with all-channel, double-folded dipole antenna and 60 ft. of lead-in wire.

MODEL 10A TV KIT, less cabinet.....Net \$199.00
MODEL 12A TV KIT, same as above, but has a 12" picture tube.....Net \$263.00

NEW STREAMLINED CABINETS

for Transvision Model 10A or 12A TV Kit. Made of select grain walnut with beautiful rubbed finish. Fully drilled, ready for installation of assembled receiver. Walnut Cabinet for 10A or 12A (Specify)....Net \$44.95 Mahogany and Blonde slightly higher.



ALL-CHANNEL BOOSTER

TRANSVISION ALL-CHANNEL TELEVISION BOOSTER

To assure television reception in weak signal areas, or areas which are out of range of certain broadcast stations, Transvision engineers have designed this new booster. It increases signal strength on all television channels. Tunes all television channels continuously. Can be used with any type of television receiver. Unusually high gain in upper television channels.

Model B-1LIST \$39.95

TRANSVISION REMOTE CONTROL UNIT KIT

Will operate any TV receiver from a distance. Turns set on, tunes in stations, controls contrast and brightness, turns set off. Ideal for installations where the television receiver is inaccessible. Tuner unit is a high gain, all-channel unit with about 50 micro-volt sensitivity. Easy to assemble in about an hour.

Model TRCU, with 25 feet of cable.....NET \$44.50
Without cabinetNET \$42.50



REMOTE CONTROL UNIT KIT

NEW . . . TRANSVISION SWEEP SIGNAL GENERATOR for Television and FM

Complete frequency coverage from 0-227 MC with no band switching. . . . Sweep width from 0-12 MC completely variable. . . . Accurately calibrated built-in marker generator.

OUTSTANDING FEATURES: (1) Frequency range from: 0-227 MC. . . (2) Dial calibrated in frequency. . . (3) Sweep width from 0-12 MC completely variable. . . (4) Self-contained markers readable directly on the dial to .5% or better. (No external generator required to drive the marker signals). . . (5) Crystal controlled output makes possible any crystal controlled frequency from 5-230 MC. . . (6) Plenty of voltage output—permits stage-by-stage alignment. . . (7) Output impedance 5-125 ohms. . . (8) Directly calibrated markers, 20-30 MC for trap, sound and video IF alignment. . . (9) RF for alignment of traps or IF channels when a DC volt meter is used as the indicating medium. . . (10) Unmodulated RF signal to provide marker plus simultaneously with the main variable oscillator. . . (11) Markers can be controlled as to output strength in the pip oscillator. . . (12) Power supply completely shielded and filtered to prevent leakage. . . (13) All active tubes are the new modern miniature type. . . (14) Phasing control incorporated in the generator.

MODEL NO. SG.....Net \$99.50



SWEEP SIGNAL GENERATOR

NEW 8-PAGE CATALOG showing complete Transvision line now available at your distributor, or write to:

TRANSVISION, Inc. Dept. RE New Rochelle, N. Y.

In Calif.: Transvision of California, 8572 Santa Monica Blvd., Hollywood 46.

All prices 5% higher west of Mississippi; all prices fair traded. All Prices Subject to Change Without Notice.

RADIOMEN...You Can GET INTO The TELEVISION BUSINESS IN A BIG WAY WITH THE TRANSVISION DEALER PLAN

Write for **FOLDER D-1**

(1) Connect the power supply to the exciter, switch on the heater voltage and allow a few minutes for the tubes to reach operating temperature.

(2) Connect two or three feet of insulated wire to J1 to act as a simple antenna.

(3) Set SW to position 1, switch on the d.c. voltage, and tune C5 for maximum meter reading.

(4) Set SW to position 2 and tune C10 for minimum meter reading.

(5) Turn the meter switch to position 3 and readjust C10 for maximum meter swing.

(6) Turn to position 4 and adjust C15 for meter minimum.

(7) Check the exciter's output frequency with a heterodyne frequency meter or other suitable device to make sure the quadrupler output is at 75 meters.

(8) Switch on a nearby receiver or FM monitor and tune to the exciter's output frequency.

(9) Plug a crystal or dynamic microphone into J2.

(10) Advance the clipper control R18 approximately half way and, while whistling into the microphone, adjust R27 until the desired frequency swing is obtained, as observed with the receiver or monitor. Speak into the microphone and note the voice quality. Reduce the setting of R27, if necessary, to improve quality. R27 ordinarily will not need any further adjustment after this setting has been made. Later it will be necessary to adjust only clipper control R18 to fix deviation.

(11) Couple the exciter to the transmitter and readjust C15 with the meter switch set to position 4 (see step 6).

Fig. 3 shows several circuits for coupling the exciter to a transmitter. Fig. 3-c is the best arrangement. Fig. 3-a's arrangement will be satisfactory only if the original oscillator tube is a well screened tetrode or pentode and if the tuned circuit (L-C1) is enclosed in a metal can, otherwise t.p.t.g. oscillations will be set up between the input tuned circuit and the oscillator plate tank. C2 is a 50- μ f mica capacitor. Circuit 3-b is simple and convenient, but will be entirely satisfactory only when the oscillator tube in the transmitter provides considerable gain. C is a 50- to 100- μ f mica capacitor. In extreme cases, it may be necessary to operate the second 6V6-GT/G tube in the exciter as a doubler. The oscillator in the transmitter then will operate also as a doubler.

It is best to do a little experimenting to determine which coupling arrangement will supply normal excitation to your own transmitter.

If you modify the unit for mounting in a cabinet or rack, the crystal socket may be placed on the front panel instead of on the chassis. If you like to QSY rapidly, purchase several crystals between 481.625 kc and 487.125 kc. Wire them so any one can be selected at will with a rotary switch on the panel. Connect the switch between C1 and the top plate of the crystal holders.

**LOW
FACTORY
PRICES!**

... on the Sensationally NEW 1949
MIDWEST RADIOS

**NEW
SERIES 16
SUPER DE LUXE
AM-FM
CHASSIS**

30 DAYS TRIAL

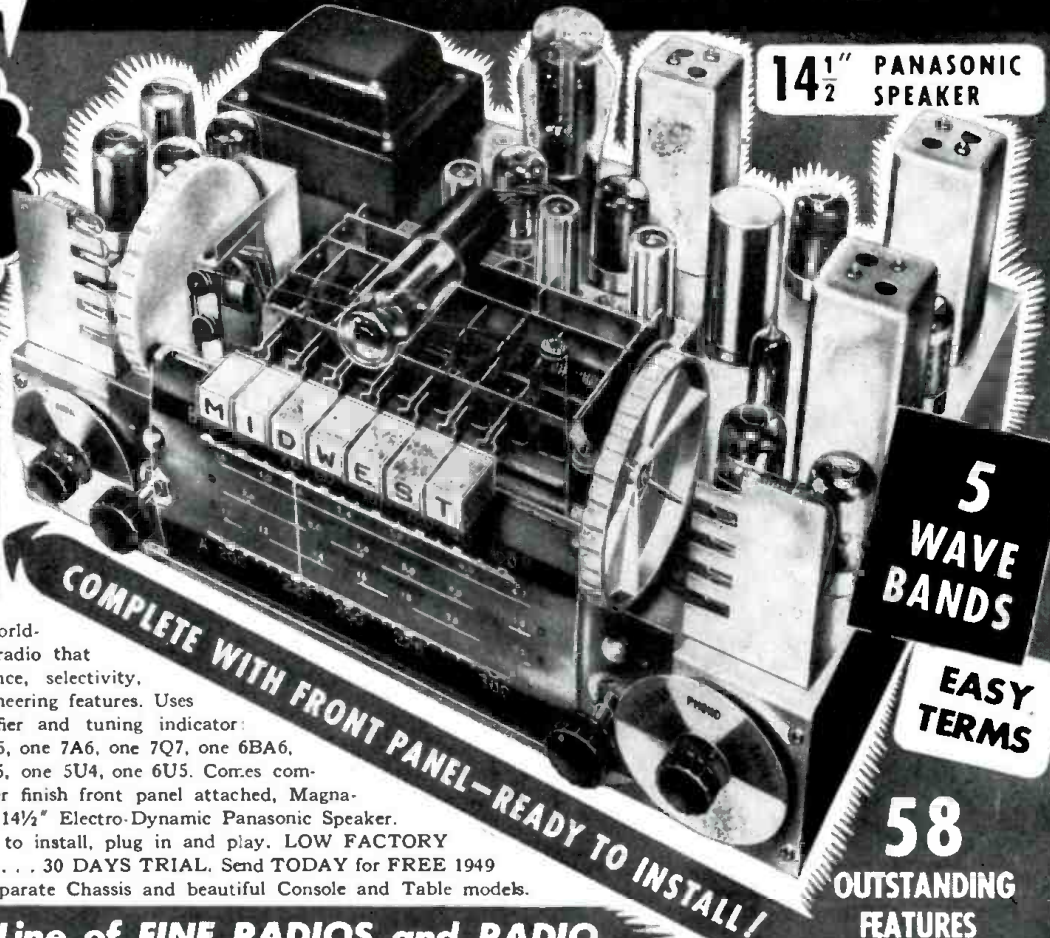

**14 1/2" PANASONIC
SPEAKER**

**5
WAVE
BANDS**

**EASY
TERMS**

**58
OUTSTANDING
FEATURES**

COMPLETE WITH FRONT PANEL—READY TO INSTALL!

Here is the last word in radio engineering . . . a powerful, world-ranging, magnificently-toned radio that is unsurpassed for performance, selectivity, sensitivity, and advanced engineering features. Uses these latest-type tubes, rectifier and tuning indicator: three 7A7, three 7A4, two 7C5, one 7A6, one 7Q7, one 6BA6, one 6BE6, one 6C4, one 6AL5, one 5U4, one 6U5. Comes complete with satin stripe copper finish front panel attached, Magna-Tenna Loop Aerial and giant 14 1/2" Electro-Dynamic Panasonic Speaker. Requires only a few minutes to install, plug in and play. **LOW FACTORY PRICES . . . EASY TERMS . . . 30 DAYS TRIAL.** Send TODAY for FREE 1949 Midwest Radio Catalog of separate Chassis and beautiful Console and Table models.

- Including the Exclusive Midwest
- FLASH-O-MATIC Volume and Band Indication
- TELEVISION Audio Switch-Over
- FIDEL-A-STAT Color-Ray Tone Selection
- TRI-MAGNADYNE Coil System
- ...Plus NO-DRIFT FM and many other features

A Complete Line of FINE RADIOS and RADIO-PHONOGRAPHS . . . Available in SEPARATE CHASSIS Like the POWERFUL SERIES 16 AM-FM Model above or in COMPLETE CONSOLES like this...



**Beautiful
SYMPHONY GRAND
AM-FM Radio-Phonograph with
TELEVISION Audio Switch-Over
and NEW Intermix AUTOMATIC
RECORD CHANGER**

A Magnificent musical instrument and a masterpiece of cabinet design—the finest Midwest Radio in 29 years of manufacture. Offers world-ranging radio reception and newest automatic Intermix Record Changing Phonograph. Uses Series 16 Super DeLuxe AM-FM Chassis. Giant 14 1/2" Panasonic Speaker; Tri-Magnadyne Coil System; Built-In Loop Antenna. Other luxurious console and table model cabinets available with Series 16, 12, and 8 chassis—on Easy Terms and 30 Days Free Trial.

Rush for Free Catalog!

FILL IN COUPON AND MAIL TODAY OR JUST SEND NAME AND ADDRESS ON 1c POSTCARD

MIDWEST RADIO & TELEVISION CORP.
Dept. 384 909 Broadway, Cincinnati 2, Ohio

Please send me your new FREE 1949 Catalog.

NAME _____
ADDRESS _____
CITY _____ ZONE _____ STATE _____

BUY DIRECT FROM FACTORY and SAVE!
MIDWEST RADIO & TELEVISION CORP.
Dept. 384 909 Broadway, CINCINNATI 2, OHIO



Regulated variable supply, top front view.

ONE handy helper in the builder's and experimenter's shop is a variable-voltage regulated power supply, which will provide a well-filtered d.c. output at any voltage within its range and will maintain that voltage, regardless of variations in line voltage or load current. A typical commercial model may supply several hundred milliamperes of output current at voltages up to 400 or so, but for use in the home workshop a small and inexpensive unit is more appropriate.

The little supply shown in the photographs provides a variable output voltage from 30 to 250, regulated to within approximately 1% for variations in output current between 0 and 50 ma and for variations in line voltage between 105 and 125. Voltages below 30 and above 250 are also available, but at some sacrifice of regulation. Several amperes of 6.3-volt heater current are also provided in the output. The unit may be built on a small chassis or breadboard. Construction and wiring are not at all critical.

The circuit employs a 6X5-GT as full-wave rectifier and a 6V6-GT as the main control tube. One half of a 6SL7-GT serves as regulator amplifier, while the other half of the same tube

is used as a simple diode rectifier for the negative reference voltage. Two type NE12 neon lamps serve as the voltage standard, and one of these also acts as a pilot light, visible at the front of the chassis.

The 6SL7-GT amplifier amplifies dif-

to maintain an essentially constant output voltage.

The output voltage is varied by adjusting the amount of voltage applied to the grid of the 6SL7-GT amplifier with R5.

Adequate filtering (C1 and C2),

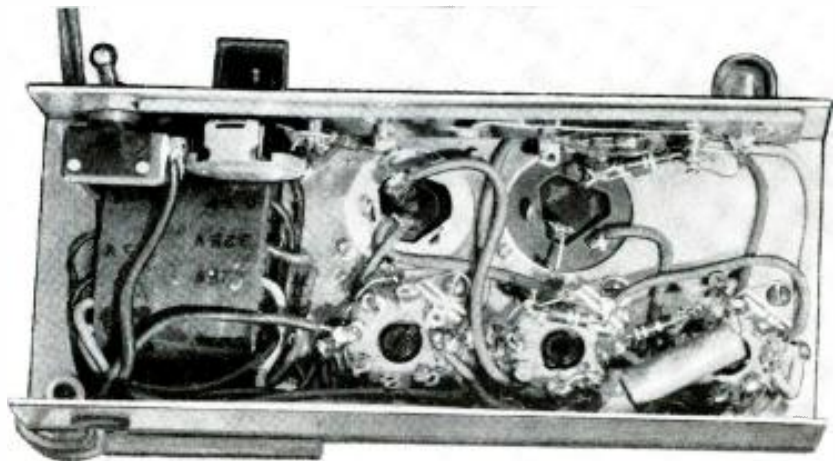

Under-chassis view. N2 was added just inside chassis from N1, after the photo was taken.

ferences between the output and the negative reference voltage. Its plate is connected to the grid of the 6V6-GT. The supply's output current flows through the 6V6-GT, and variations in its grid potential change its internal impedance and, consequently the voltage drop across it. Effectively the 6V6-GT is a variable resistor. Its resistance is controlled by the 6SL7-GT amplifier so as

combined with the regulating action itself, assures pure d.c. at whatever voltage you select—and the low internal resistance of the supply means that your decoupling problems will be minimized. Next time you have a job of construction or testing or debugging a small receiver or audio amplifier, put this little power supply to work and see how much easier your job becomes.

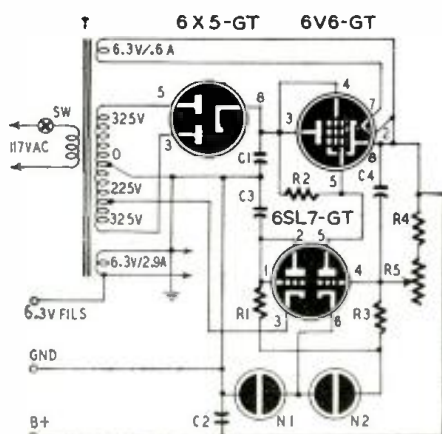

R1—33,000 ohms, 1/2 watt
R2—470,000 ohms, 1/2 watt
R3—150,000 ohms, 1/2 watt
R4—82,000 ohms, 1/2 watt
R5—500,000-ohm potentiometer
C1, C2, C3—20- μ f, 450-volt electrolytic
C4—01- μ f 400-volt paper
N1, N2—type NE-2 neon lamps
T—power transformer, 650 volts, c.f., 50 ma, tap at 225 volts; 6.3 volts, 600 ma; 6.3 volts, 2.9 amps. (Raytheon U-10544)
SW—s.p.s.t. toggle switch

TELEVISION OSCILLATOR

Since all television picture tubes using electrostatic deflection require push-pull signals, several tubes are usually used. The circuit shown uses only one—a combination blocking oscillator and phase inverter using one half of a 6SN7. The circuit gives about 25 volts output and makes a fine horizontal oscillator for a homemade TV receiver.

The transformer can be any horizontal blocking oscillator unit, or it may be wound at home on a large powdered-iron slug. The grid winding should be about 1,000 turns of No. 36 enameled wire, and the plate coil about 2,000 turns of the same.

The resistor across the grid winding should be varied until a wave with good saw-tooth form is obtained.

ROBERT A. CUNNINGHAM,
Newport, Ky.

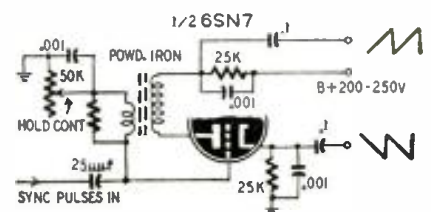

MONEY BACK GUARANTEE — We believe units offered for sale by mail order should be sold only on a "Money-Back-If-Not-Satisfied" basis. We carefully check the design, calibration and value of all items advertised by us and unhesitatingly offer all merchandise subject to a return for credit or refund. You, the customer, are the sole judge as to value of the item or items you have purchased.

BUILD YOUR OWN SIGNAL TRACER and **SAVE!!**



THE MODEL CA-12 KIT COMES COMPLETELY ASSEMBLED. Can be wired in 30 minutes. Components and circuit guaranteed to meet the following:

The Only Signal Tracer in the Low Price Range Including BOTH METER AND SPEAKER!!

We are pleased to announce we have obtained an exclusive franchise to distribute the well known Model CA-12 Signal Tracer in kit form. The Model CA-12 sells regularly for \$29.95, here is your opportunity to save \$8.00 with the added advantage of complete familiarity of design and operation made possible when you build your own instrument.

FEATURES: ★ Comparative intensity of the signal is read directly on the meter—quality of the signal is heard in the speaker. ★ Simple to operate—only one connecting cable—no tuning controls. ★ Highly sensitive—uses an improved vacuum-tube voltmeter circuit. ★ Tube and resistor capacity network are built into the detector probe. ★ Built-in high gain amplifier—Alnico V speaker. ★ Completely portable—weighs 8 pounds—measures 5½" x 6½" x 9".

MODEL CA-12 Kit includes ALL PARTS assembled and ready for wiring, circuit diagram and detailed operating data for the completed instrument \$21.95

\$21⁹⁵

MODEL CA-12 COMPLETELY WIRED READY TO OPERATE \$29.95

THE NEW MODEL 670

SUPER METER



SUPER METER. A Combination VOLT - OHM - MILLIAMMETER plus CAPACITY REACTANCE, INDUCTANCE and DECIBEL MEASUREMENTS.

D.C. VOLTS: 0 to 7.5/15/75/150/750/1500/7500. A.C. VOLTS: 0 to 15/30/150/300/1500/3000 Volts. OUTPUT VOLTS: 0 to 15/30/150/300/1500/3000. D.C. CURRENT: 0 to 1.5/15/150 ma.; 0 to 1.5 Amps. RESISTANCE: 0 to 500/100,000 ohms, 0 to 10 Megohms. CAPACITY: .001 to 2 Mfd., .1 to 4 Mfd. (Quality test for electrolytics.) REACTANCE: 700 to 27,000 Ohms; 13,000 Ohms to 3 Megohms.

INDUCTANCE: 1.75 to 70 Henries; 35 to 8,000 Henries.

DECIBELS: -10 to +18, +10 to +38, +30 to +58.

The model 670 comes housed in a rugged, crackle-finished steel cabinet complete with test leads and operating instructions. Size 5½" x 7½" x 3". **\$2840 NET**

The New Model 770 — An Accurate Pocket-Size

VOLT-OHM MILLIAMMETER



(Sensitivity: 1000 ohms per volt)

Features:

Compact—measures 3¼" x 5½" x 2¼". Uses latest design 2% accurate 1 Mil. D'Arsonval type meter. Same zero adjustment holds for both resistance ranges. It is not necessary to readjust when switching from one resistance range to another. This is an important time-saving feature never before included in a V.O.M. in this price range. Housed in round-cornered, molded case. Beautiful black etched panel. Depressed letters filled with permanent white, insures long-life even with constant use.

Specifications: 6 A.C. VOLTAGE RANGES: 0-15/30/150/300/1500/3000 volts.

6 D.C. VOLTAGE RANGES: 0-7½/15/75/150/750/1500 volts.

4 D.C. CURRENT RANGES: 0-1½/15/150 Ma. 0-1½ Amps.

2 RESISTANCE RANGES: 0-500 ohms. 0-1 Megohm.

The Model 770 comes complete with self-contained batteries, test leads and all operating instructions. **\$1390 NET**

The Model S-35 — a POWERFUL

REFLEX PROJECTOR

COMPLETE WITH WESTERN ELECTRIC

BUILT-IN DRIVER UNIT

CONSERVATIVELY RATED AT 35 WATTS—WILL EASILY HANDLE UP TO 55 WATTS WITHOUT BLASTING

Heavy gauge aluminum in the main trumpet section completely eliminates blasting and blistering. New plastic diaphragm overcomes the resonant peaks of the old type; also it is absolutely impervious to atmospheric changes whereas the old type was subject to atmospheric corrosion. Complete unit unconditionally guaranteed for one year.

Specifications

POWER (CONSERVATIVE) — 35 WATTS; AIR COLUMN—3½ FT.;

DISPERSION—80°; POWER (PEAK)—55 WATTS; BELL DIAMETER—

—15"; IMPEDANCE—8 ohms; FREQUENCY RANGE—130 to 5000

C.P.S. PROJECTION — ½ mile;

FINISH — Attractive two tone crystalline.

The Model S-35 Comes Complete with Built-in Driver Unit, ONLY **\$2850 NET**



The Model 88 — A COMBINATION

SIGNAL GENERATOR AND SIGNAL TRACER



Signal Generator Specifications:

*Frequency Range: 150 Kilocycles to 50 Megacycles. *The R.F. Signal Frequency is kept completely constant at all output levels. *Modulation is accomplished by Grid-blocking action which is equally effective for alignment of amplitude and frequency modulation as well as for television receivers. *R.F. obtainable separately or modulated by the Audio Frequency.

Signal Tracer Specifications:

*Uses the new Sylvania 1N34 Germanium crystal Diode which combined with a resistance-capacity network provides a frequency range of 300 cycles to 50 Megacycles. **\$2885 NET**

The Model 88 comes complete with all test leads and operating instructions. ONLY

20% DEPOSIT REQUIRED ON ALL C.O.D. ORDERS

GENERAL ELECTRONIC DISTRIBUTING CO. DEPT. RE-12 98 PARK PLACE NEW YORK 7, N. Y.

JUST OUT!

All the "Know How" of
AUTO RADIO REPAIR
in one handy training book... for only \$7.50



SERVICING THE MODERN CAR RADIO

BY A. L. HURLBUT
Auto Radio Service
Manager and Design
Consultant

Second Edition, 702 pages, 8 1/2 x 11, 222 illustrations, over 500 diagrams, \$7.50.

Practical, easily understood data on

- Entering the Car Radio Field
- Principal Differences between Mobile and Home Radios
- Automobile Antennas
- Antenna Input Circuits
- The Power Supply
- Typical Circuit Features
- The Automotive Electrical System
- Setting Up the Car Radio Service Station
- Installing the Car Set
- Installing the Antenna
- Loudspeaker Installation
- Interference
- Servicing Procedure
- Vibrator Maintenance
- Servicing the Loud speaker
- Car Radio Alignment
- Push-button Tuning

and over 500 specific car radio circuit diagrams!

MAKES THE WORK TWICE AS EASY

Covers all auto radio types from mid-1930's to the present, including mobile FM receivers

Here—written by a practical auto radio expert of 20 Years' standing—is just the data you need to repair car radios faster, easier, and a lot more profitably! A. L. Hurlbut's **SERVICING THE MODERN CAR RADIO** is the only book devoted solely to this fast-growing service field. Explains every detail of the work clearly—and tops this off with 222 illustrations and over 500 circuit diagrams covering specific service details on every type of automotive radio in use.

COMPLETE THEORY—TEST—INSTALLATION—ANTENNA—AND SERVICE DATA

It is the only single book that includes needed data to transform a good home-radio serviceman into a car-radio expert. Describes circuits. Explains automotive electrical units, their function and effect on radio performance. Tells how to install car radios properly and why they should be installed that way. Provides circuit diagrams on hundreds of popular models and contains ample data to help you do a good job on sets for which diagrams are not readily available. Gives full details on proper antenna mounting; contains pertinent information on FM receivers; tells how to get business, how to deal with auto radio service customers, and how to set up your shop, test bench, etc., for maximum efficiency in this specialized, fast-growing field. In short, **SERVICING THE MODERN CAR RADIO** provides at your fingertips a complete, easily understood encyclopedia of facts, methods and data for operating a complete auto radio service station. Use **FREE EXAMINATION** coupon today!

formation on FM receivers; tells how to get business, how to deal with auto radio service customers, and how to set up your shop, test bench, etc., for maximum efficiency in this specialized, fast-growing field. In short, **SERVICING THE MODERN CAR RADIO** provides at your fingertips a complete, easily understood encyclopedia of facts, methods and data for operating a complete auto radio service station. Use **FREE EXAMINATION** coupon today!

OPPORTUNITY OF A LIFETIME

for alert servicemen, says A. A. Ghirardi!

Take this advice from A. A. Ghirardi, author of hundreds of well-known service books and articles! "I have read Hurlbut's **SERVICING THE MODERN CAR RADIO** from cover to cover. I sincerely believe it represents an opportunity no wide awake serviceman can afford to miss. For nowhere in radio today is there a better chance to build business, increase profits, step ahead of competition!"



Read it 10 Days at our Risk!

OVER 9,000,000 CAR RADIOS!

"Just think of it! Approximately 16 out of every 100 sets in use in the U.S. are car radios—and this percentage is increasing every day. Good automotive radio servicemen are scarce—and Mr. Hurlbut gives a gold mine of information you need to cash in on this profitable business!"

10 DAYS' FREE EXAMINATION

Murray Hill Books, Inc. (Division of Rinehart & Co.)
Dept. RE-128, 232 Madison Ave., New York 16, N. Y.

Send me the new Second Edition of Hurlbut's **Servicing the Modern Car Radio** for 10 days' examination on approval. In 10 days I will send \$7.50, plus few cents postage, or return book postpaid. Postage paid on cash orders; same return privilege. (Books sent on approval in U.S. only. Price outside U.S., \$8.00, postpaid.)

Name

Address

City (Zone) & State

Occupation

\$3.00 FOR CARTOON IDEAS

RADIO-ELECTRONICS prints several radio cartoons every month. Readers are invited to contribute humorous radio ideas which can be used in cartoon form. It is not necessary that you draw a sketch, unless you wish.

IDEAS NOT WANTED

No electrical or radio definitions wanted. Some of these were published in the past, but the subject is about exhausted. All checks are payable on publication.

Address
RADIO CARTOONS, RADIO-ELECTRONICS
25 West Broadway, New York 7, N. Y.

SHANEY'S
New
20 STEPS to PERFECT AMPLIFICATION
SEND 3c STAMP FOR POSTAGE
AMPLIFIER CORP. of AMERICA
398-10 Broadway New York 13, N. Y.

RADIO-ELECTRONICS wants *Technotes* describing common troubles of well-known receivers or telling how rare or difficult problems were solved. A six-month subscription will be awarded for each unillustrated and a one-year subscription for each illustrated *Technote* published.

MAJESTIC 7YR772

When plugged in on some power lines, the set had a loud hum on local stations. I remedied this by connecting a .01- μ f capacitor across the line.

ALBERT BALZUM,
Ada, Minn.

AUTOMATIC RADIO TOM THUMB

Sound was very distorted when the set was operated on a.c. Replacing a discharged A-battery cured the distortion.

ROLAND H. DERY,
Woonsocket, R. I.

MINIATURE TUBES

Some receivers using miniature tubes are noisy because of resistance between the tube pins and the socket lugs. Better contact can be made sometimes by bending the tube pins outward slightly to make a force-fit.

JAMES LETZELTER,
East Greenbush, N. Y.

EMERSON 577 AM-FM

A large amount of frequency drift is caused by the heat of the 25L6, the 25Z6, and the ballast resistor. The holes in the fiber back are too small to allow good circulation of air.

I used a miniature tube-socket punch to make six 5/8-inch holes in the back, after which drift was reduced almost to the vanishing point.

ARNOLD MARGOLIS,
Bronx, N. Y.

AUDIO DISTORTION

An old receiver showed excessive distortion after a five-minute warmup. The voltmeter showed that bias on the output tube started at -15 volts when the set was first turned on, rose to zero, and then started climbing in the positive direction. A new 41 in the output stage cleared up the trouble.

DAVID GNESSIN,
Columbus, Ohio

TUNING EYES

Some receivers with tuning eyes do not have sufficient sensitivity to close the eye unless they are close to the transmitter. In the country, the eye is almost useless. When the eye tube is a 6U5/6G5, replacing it with a 6E5 will often make the eye operate excellently. The 6E5 requires only about one-third the grid voltage of the 6U5 to close the eye.

ALAN SMITH,
Shaftesbury, Vt.

SILVERTONE RECORDERS

Silvertone wire recorders frequently chatter when the wire is rewinding. To stop this, clean any oil or grease from the idler wheels, then hold a pencil eraser against the aluminum idler for a few seconds while it is running. Grease the idler bearings with a very small amount of Marfak No. 3 lubricant.

ALAN MCFARLANE,
Aberdeen, S. D.

AUTHORIZED DeWALD DISTRIBUTORS



DeWALD NO. BT-100
NOTHING FINER
MADE IN A 10 INCH
TELEVISION RECEIVER
Regardless of Price

- Chassis Illustrated Below
- 27 Tubes Plus Three Rectifiers
- All 13 Channels
- 25 1/2 x 15 x 19"

LIST . . \$375.00

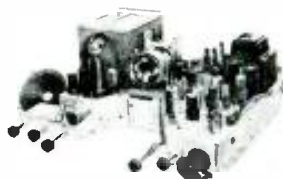

THE HOTTEST ITEM OF THE YEAR
DeWALD NO. BT-100
TELEVISION CHASSIS
COMPLETE—READY TO OPERATE
MAKES CONVERSIONS:
● SIMPLE ● FOOLPROOF
● HIGHLY SUCCESSFUL

SPECIAL NET PRICE



DeWALD MODEL B-614
**DUAL SPEED RADIO
PHONOGRAPH COMBINATION**

- QUALITY SUPERHET RADIO
- FIVE TUBES PLUS RECTIFIER
- PLAYS STANDARD RECORDS
- PLAYS LONG PLAYING RECORDS

LIST \$69.95

SIZE: 17 x 8 1/2 x 14"



DeWALD MODEL B-510
WORLD WIDE RADIO
THREE BANDS

- BROADCAST: 535-1650 KC
- SHORTWAVE: 121.2-63 METERS
- FOREIGN: 63-125 METERS
- PRECISION ENGINEERED
- BEAM POWERED OUTPUT

LIST \$39.95

SIZE: 6 1/2 x 11 x 5 7/8"



DeWALD MODEL B-403
RADIO CLOCK

DOUBLE-UTILITY COMBINATION
SELF-STARTING ELECTRIC CLOCK
P.M. DYNAMIC SPEAKER
BEAM POWER OUTPUT
IVORY, MAHOG., MAPLE, MAROON

LIST \$29.95

SIZE: 6 1/2 x 10 x 5 3/4"



DeWALD MODEL B-504
3-WAY PORTABLE

- BEAUTIFUL SHATTERPROOF CABINET
- SUPERHET 4 TUBES PLUS RECTIFIER
- INSTANTANEOUS OPERATION
- PLAYS ON A.C. or D.C.
- BATTERY SUPPLY—1-67 1/2 V: 1-4 1/2 V.
- SIZE: 4 x 8 1/2 x 7 1/2"

LIST, LESS BATTERIES \$29.95

ATTRACTIVE DEALER PRICES

WRITE • WIRE • PHONE

TELEVISION TUBES	
Standard Brands	
5U4	.59
5V4	.85
6J5	.49
6J6	.85
6K6	.49
6AC7	.79
6AG5	.79
6AK5	.75
6AL5	.85
6AT6	.69
6BA6	.79
6BG6	1.90
6SH7	.55
6SK7	.49
6SL7	.59
6SN7	.59
8016	1.85
7EP4	15.25
10BP4	34.50

CONDENSERS	
PER 100	
.001-600V	3.95
.006-600V	4.40
.01 -600V	4.40
.02 -600V	4.95
.05 -600V	4.95
.1 -600V	7.20

EACH	
.25 - 600V	.12
.5 - 600V	.17
10 - 50V	.22
16 - 150V	.18
20 - 150V	.24
20/20 - 150V	.26
30 - 150V	.28
50/30 - 150V	.44
4 - 450V	.24
8 - 450V	.27
16 - 450V	.36
16/16 - 450V	.59
20 - 450V	.39
30 - 450V	.47
40 - 450V	.59
80 - 450V	.97
.005 - 1700V	.13
.008 - 1700V	.15
.01 - 1700V	.17
.02 - 1700V	.19
.05 - 2500V	.58
.1 - 2500V	.64
.25 - 2500V	.86
.05 - 3000V	.69
.003 - 5000V	.57
.005 - 5000V	.62
.01 - 5000V	.74
.05 - 5000V	.97
.0005- 7500V	.58
.003 - 7500V	.67
.005 - 7500V	.72
.0005-10000V	.64

FIRST TELEVISION OPPORTUNITY OF ITS KIND EVER OFFERED!

\$140.60 Worth of Components for

RCA 630 TS \$39⁵⁰
Sale Price

All Brand New in Sealed Cartons

Part No.	Description	List Price
201/D1	DEFLECTION YOKE	\$13.75
201/R1	WIDTH CONTROL	1.30
201/R3	HORIZONTAL CONTROL	1.40
201/T6	POWER TRANSFORMER	50.00
201/X1	YOKE MOUNTING HOOD	2.75
204/L1	FILAMENT CHOKE	.30
204/T2	TRANSFORMER, vertical out-put	9.00
204/X2	VIDEO and I.F. KIT	35.00
208/T2	TRANSFORMER, vertical blocking	5.70
208/T3	TRANSFORMER, horizontal blocking	4.55
211/T1	TRANSFORMER, horizontal output	16.85

Total List Price, \$140.60

ALL FOR \$39⁵⁰ COMPLETE

FM CONDENSER & COIL KIT (88 to 108mc)

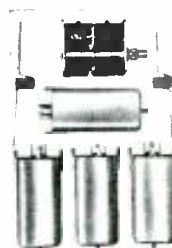

- Variable Condenser
- Discriminator Coil
- Oscillator Coil
- Two I.F. Coils
- Limiter Coil
- Antenna Coil

This Kit contains the vital parts needed to build an FM Tuner or Radio and for modernizing Pre-War FM Sets; all other parts needed are standard.

\$4.95

COMPLETE WITH INSTRUCTIONS AND DIAGRAM

SUPERIOR #770

VOLT-OHM MILLIAMETER



- POCKET SIZE—3 1/8 x 5 7/8 x 2 1/2"
- SENSITIVITY — 1000 ohms per volt
- CONSTANT ZERO ADJUSTMENT
- 6 A.C. VOLTAGE RANGES (0-15 30 150 300 1500 3000)
- 6 D.C. VOLTAGE RANGES (0-7.5 15 75 150 750 1500)
- 4 D.C. CURRENT RANGES (0-1.5 15 150 MA 0-1.5 Amps)
- 2-RESISTANCE RANGES (0-500 ohms, 0-1 Megohm)

Complete with batteries, Test Leads, Instructions and guarantee **\$13.90**

SOLVE YOUR TELEVISION INSTALLATION PROBLEMS AND SAVE MONEY!

TWIN LEAD-IN, 300 Ohms, 100 ft.	\$ 1.95
" " " " 500 ft.	7.95
" " " " 1000 ft.	13.75
CO-AX CABLE RG59U 100 ft.	5.25
" " " " 500 ft.	24.75

PHILSON ALL-WAVE TELEVISION ANTENNA



- All 13 Channels
- Aluminum Construction
- Lucite Insulation
- 8 Foot Upright
- List Price \$25.00

YOUR PRICE, \$13.75

BROOKS RADIO DIST. CORP., 80 VESEY ST., (Dept. A) NEW YORK 7, N. Y. CO. 7-2312

FOUR-HOUR RECORDER

Amplifier Corp. of America
New York, N. Y.

A long-playing version of the Twin-Trax Magnetape recorder, this unit has a continuous playing time of four hours. Using the same mechanism and two-track feature as the model described



in the October issue of RADIO-ELECTRONICS (page 42), the Model 910-B uses 4,900-foot reels of tape. The reels are mounted parallel to the sides of the cabinet and are coupled to the driving mechanism in such a way that standard 7-inch, 1-hour reels can be used on top of the recorder chassis.

The 55-pound cabinet contains complete amplifier, power supply, and supersonic generation components. A rotary counter is available for locating any selected sections of the recording.

METAL-CASE SPEAKER

Tarrytown Metalcraft Corp.
Tarrytown, N. Y.

A 4-inch Utah speaker is inclosed in a heavy cast-aluminum case which will withstand rough handling. The speaker has a 1/2-ounce Alnico magnet and a



voice coil of 4 ohms impedance. A 5-ohm volume control is provided. Key slots on the rear of the case permit mounting the unit on a wall.

BUS FM RECEIVER

General Electric Co.
Syracuse, N. Y.

A new FM receiver, designed specifically for installation in buses, will operate up to eight speakers.

The set incorporates a crystal-controlled local oscillator and a vibrator power pack. Employing 10 tubes, it has double limiters for optimum quieting. The crystal is a new design, operating on the third mechanical mode and requiring a frequency multiplication of only three.

Of metal construction, the receiver can be mounted directly behind the



driver's seat, under a passenger seat, or in any other suitable location. The speakers are in round metal housings mounted on the ceiling at intervals throughout the length of the bus. A matched dipole antenna is used with the set, and can be mounted on the bus in either a crosswise or lengthwise position.

NOVEL MICROPHONE

Amperite Co., Inc.
New York, N. Y.

This RB velocity microphone eliminates the usual blasting effects produced by shouting into an ordinary microphone. The abrupt difference in output caused by moving away is also reduced.

The frequency response is from 50 to 11,000 cycles \pm 2 db, and the harmonic distortion is less than 1%. Output level is -62 db. Angular discrimination from 60 to 10,000 cycles is less than 5%.

The microphone is available in high- and low-impedance models. Both come complete with a cable connector and a switch which is hidden to prevent tampering.

RADIO PROGRAM TIMERS

Montgomery Manufacturing Co.
Chicago, Ill.

The new line of synchronous program timers is particularly suited for accurate control of public address, radio, chimes, or any other system of wired or direct reproduction. These units can be set exactly for the times programs

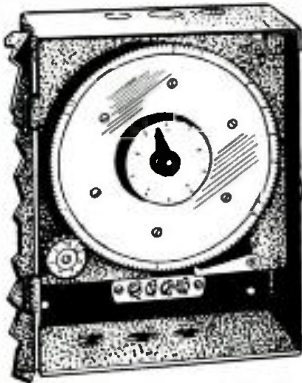

are to be switched on and off with any desired interval as low as 2 1/2 minutes. As many as 288 operations per day can be set on the program disc. A calendar switch is provided which can be set to silence the program through as many 12- or 24-hour periods as desired in any week. Thus a single operation or a full week's program which will be continuously repeated until reset can be set up on the timer.

HIGH-VOLTAGE PROBES

Precision Apparatus Co., Inc.
Elmhurst, N. Y.

Series TV high-voltage safety test probes are designed for use in conjunction with standard test sets and v.t.v.m.'s. Voltages up to 30,000, such



as are used in television receivers, may be measured without danger to the serviceman. Stock tubular multipliers are available for use with the probes, eliminating the necessity for a special instrument. The multipliers are placed within the probe.

Safety provisions include a multi-channelled guard barrier, full handle-length internal arc-back shield which is directly grounded, an external arc-back shield, and a shielded cable. All high-voltage and ground connections within the probe are made with high-compression contact springs. The probe head is made of polystyrene, the remainder of the instrument being constructed of bakelite and lucite.

REMOTE BROADCAST AMPLIFIER

Radio Corporation of America
Camden, N. J.

The new BN-2A portable remote amplifier has three input gain controls and

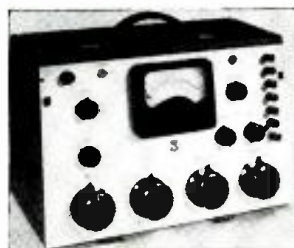

four input channels, the third and fourth being switched to one control. Because of excellent frequency response, low noise level, and low distortion, the maker recommends the amplifier for FM as well as AM.

Though the unit weighs only 29 pounds and is only 14 1/2 inches long, it has a self-contained, 117-volt a.c. power supply, as well as provision for battery operation. Gain of each channel is 92.5 db. High-level mixing is used. Provisions for switching the amplifier output to a PA system as well as the line are included, making the amplifier suitable for almost any remote pickup.

S.S.S.C. SELECTOR

General Electric Co.,
Syracuse, N. Y.

The YRS-1 Single-Sideband suppressed carrier Selector selects either sideband at the receiver with simple push-button controls. No tuning need be done. Carrier drift is followed, within limits, by means of a locked oscillator.

Four buttons are provided: one for dual sideband reception with reinforced carrier, one for normal reception, and one for each sideband. The device can be used with any receiver whose i.f. frequency is approximately 455 kc.

LOW-COST INTERCOMS

Operadio Manufacturing Co.
St. Charles, Ill.

The Flexifone intercommunication system is designed for applications where a small, low-cost installation is needed. The master station will handle three remote stations. The housing is die-cast metal.

**PORTABLE SERVICE KIT**

Sylvania Electric Products, Inc.
Emporium, Pa.

The new service kit is a 17 x 11 3/4 x 5 1/2-inch fabric-covered case with tool pockets in the lining of the lid. Looking more like a small suitcase than a tool kit, the case will accommodate over 75 tubes and most of the commonly used tools.

**HIGH-CURRENT RECTIFIERS**

Federal Telephone and Radio Corp.
Clifton, N. J.

Two new selenium rectifier stacks RS 400 and RS 500 with current ratings of 400 and 500 ma, respectively, have been developed. The rectifiers are similar in

appearance to other miniature stacks of this manufacturer. They are intended for use in television receivers, for recti-



fying filament voltage to avoid hum in high-gain tubes, and for other applications where high-current-capacity rectifiers are needed.

BATTERY CHARGING PLUG

P. R. Mallory & Co., Inc.
Indianapolis, Indiana

This new cigarette lighter plug is intended to help car owners charge their batteries with a minimum of effort and possibility of soiling clothes.



Made in the same shape as a standard dashboard lighter, the plug is connected to the charger and then inserted in the dash lighter receptacle. Necessity for raising the hood and connecting clips to the battery posts is eliminated, saving both time and cleaning bills.

DISPLAY TUBE TESTER

Hickok Electrical Instrument Co.
Cleveland, Ohio

The 533 DM tube tester is designed as a merchandiser to let customers see for themselves the condition of their



tubes. A 9-inch illuminated scale reads REPLACE, DOUBTFUL, and GOOD.

The tester uses the dynamic mutual conductance circuit, and the meter shows ranges of 3,000, 6,000, and 15,000 micromhos as well as the zone markings mentioned.

POCKET-SIZE TESTER

Superior Instruments Co.
New York, N. Y.

Model 770 volt-ohm-milliammeter uses a 2% accurate meter with a 1-ma movement. Voltage is measured at 1,000 ohms per volt, with a.c. full-scale ranges from 15 to 3,000 volts. D.c. voltage ranges are from 7 1/2 to 1,500. Maximum current range is 1/2 ampere, and resistances up to 1 megohm are measured in two ranges. The instrument is extremely compact, measuring 3 1/8 x 5 7/8 x 2 1/4 inches. It is suitable for carrying on outside calls.

RADIOMEN'S HEADQUARTERS ✦ WORLD WIDE MAIL ORDER SERVICE !!

GENERAL ELECTRIC 150 WATT TRANSMITTER

Cost the Government \$1800.00 • Cost to You—BRAND NEW—\$100.00

This is the famous transmitter used in U.S. Army bombers and ground stations, during the war. Its design and construction have been proved in service, under all kinds of conditions, all over the world. The entire frequency range is covered by means of plug tuning units which are included. Each tuning has its own oscillator and power amplifier coils and condensers, and antenna tuning circuit. It is designed to operate at top efficiency within its particular frequency range. Transmitter panel. Here are the specifications: **FREQUENCY RANGE**, 200 to 500 KC and from 12,000 to 12,000 KC. (With operation on 10 and 20 meter band with slight modification for which diagrams are furnished.) **OSCILLATOR**, Self excited, filament compensated, coupling circuit which matches practically any length antenna. **MID-LEVEL**, Class "B" uses two 211 tubes and equipped with antenna **STIPPLY**. Supplies power to operate set from 110V AC, 81ZL, 215-230V^{1/2}. Total shipping wt. 300 lbs., complete with all tubes, dynamotor power supply, seven tuning units, antenna tuning unit and essential plugs. NOTE: Price increases to \$100.00 effective Oct. 1, 1948.

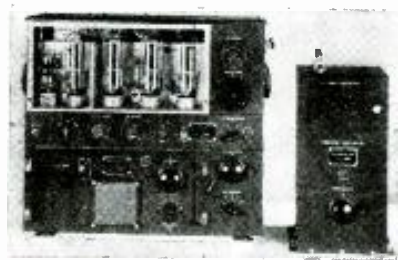

HEAT GUN

Streamlined pistol grip heat gun in rigid test housing, that delivers a powerful 20 cubic Ft. per minute blast of hot air at 160 Fahrenheit. Ordinary blowers have small fan motors, but this has a lifetime-lubricated AC-DC motor of the rugged vacuum cleaner type, that produces a hurricane of either hot or cold air. Perfect for blowing out dirt or dust from radio chassis, drying out ignition systems, warming up carburetors, quick-drying paint, thawing out radiators or water pipes, etc. Warning: Keep this away from your wife, or she will be using it to dry her hair because it will do it in half the time of her ordinary hair dryer.

to say nothing of her using it to dry stockings or to dry the refrigerator instantly. Only \$12.95. Satisfaction guaranteed or money refunded if returned prepaid within 5 days.

GENERAL ELECTRIC RT-1248 15-TUBE TRANSMITTER-RECEIVER

TERRIFIC POWER—(20 watts) on any two instantly selected, easily pre-adjusted frequencies from 435 to 500 Mc. Transmitter uses 5 tubes including Western Electric 215 A as final. Receiver uses 10 tubes including 955's, an 864 detector and oscillator, and 3-7H7's as IF's with 4 slug-tuned 40 Mc. IF transformers, plus a 7H7, 75A's and 7E7's. In addition unit contains 8 relays designed to operate any sort of external equipment when actuated by a receiver on a similar set elsewhere. Originally designed unit for 110 V AC, using any supply capable of 400 DC at 135 MA. The ideal unit for use in mobile or diagrams supplied for running the RT-1248 transmitter on either code or voice in AM or FM transmission and reception, for use as a mobile public address system, on 80 to 110 Mc, as an FM broadcast receiver, as a Facsimile transmitter or receiver, as an Amateur Television transmitter or receiver for remote control relay hookups, for Geiger-Mueller counter applications. It sells for only \$29.95 or two for \$53.90. If desired for marine or mobile use the dynamotor which will work on either 12 or 24V DC and supply all power for the set is only \$15.00 additional.



1949 MODEL MUTUAL CONDUCTANCE TUBE TESTER

No possibility of good tubes reading "Bad" or bad tubes reading "Good" as on dynamic conductance testers in other on-line emission testers. Attractive panel and case equal to any on the market in appearance. Large 1 1/2" meter. Calibrated microhm scale as well as a 100-ohm scale. Front panel fuse. Individual sockets for all tube base types. Voltages from 75 volts to 115 volts and complete switching shorts or opens on each individual section of all leaded, sealed and miniature tubes including cold cathode, made eye and voltage regulator tubes as well as all ballast resistors. Name of the nationally known manufacturer withheld because of special price offer.

- Model "C"—Shipping front counter case..... \$49.95
 - Model "P"—Handsome hand-rubbed portable case..... \$49.95
- Built in roll chart with other of above \$5.00 extra.

**TERRIFIC VALUE—
PORTABLE ELECTRIC DRILL**

(Sold at less than established factory price so we cannot mention brand name.) Only \$20.95 equipped with 1/4" Jacobs General Chuck and Key. Not an intermittent duty drill but a full size rugged tool. Most convenient type switch, natural grip handle, and balance like a six-shooter. Precision cut gears—turbine type cooling blower—extra long bushings. No stalling under heaviest pressure because of powerful 110 Volt AC-DC motor and multiple ball thrust bearing. Other bearings self-aligning lifetime-lubricating Chrysler Oilite type. Made for toughest year-in and 1 year-out service in Plant or on construction jobs. Amazing perpetual factory guarantee assures you of a lifetime of trouble-free use. 25% deposit on C.O.D.'s. Full refund if returned prepaid within five days.



**Sensational Value in
AC-DC Pocket Tester**

This analyzer, featuring a sensitive repulsion type meter housed in a bakelite case, represents the culmination of 15 years' achievement in the instrument field by a large company specializing in electronic test equipment.



- Specifications of the AC-DC Model Volt-Ohm-Milliammeter:
- AC Volts—0 to 25, 50, 125, 250
 - DC Volts—0 to 25, 50, 125, 250
 - Milliamperes AC—0 to 50
 - DC—Milliamperes—0 to 50
 - Ohms Full Scale—100 mm
 - Ohms Center Scale—200
 - Capacity—.05 to 15 Mfd.

Total Price, prepaid anywhere in the USA \$7.00. Similar DC Meter, lacking the AC operated ranges of above, \$5.50 prepaid.

RT-1655—11 tube crystal controlled superheterodyne receiver that covers the FM band. The ultra modern circuit uses the latest types of tubes including 7 miniature 6AL5's. Beautiful chassis and aluminum cabinet. Tubes and schematic supplied \$14.95

World renowned two page tenth edition of the Radio Handbook in cloth binding and hard cover at the sensational reduced price, for a limited time only, \$1.49

RT1711 Brand New 12 Tube, 110 Volt Receiver Indicator Oscilloscope complete with all tubes and power supply. Has telescoping hood over scope tubes, which is equipped with a detachable calibrated screen. Has centering and amplitude controls and two video inputs. A natural for television..... \$39.95

Latest type PM Speaker in a fully-enclosed black crackle finished metal cabinet. This speaker and case match communications receivers and in addition make perfect intercom remote stations. Our price..... \$4.50

VACUUM TUBE VOLT-OHM-CAPACITY METER

There are more features incorporated into this all purpose instrument than in any other instrument on the market regardless of price. It was designed not only to meet present conditions but to be readily adaptable to future needs. At the astonishingly low price of this precision instrument, no school, plant, lab or service shop need despair itself of the "true hook" in measuring equipment. Here are a few of the many features of this outstanding meter:

- ★ 3 inch, easy to read, meter.
- ★ DC voltage ranges from 0 to 1000 V (Input resistances as high as 1 megohm per volt).
- ★ AC voltage ranges from 0 to 1000 V (No dry disc rectifier to use and destroy the accuracy of this VACUUM TUBE VOLTMETER).
- ★ Resistance ranges from 2 to 1000 megohms.
- ★ Capacity ranges from 0.0001 to 20 MFD.
- ★ A zero center range for balancing PM discriminators.
- ★ Loading resistor built into probe.
- ★ Sturdy natural finish hard wood case.

This outstanding development of one of the leading manufacturers of test equipment costs only \$39.95 complete with all leads, as illustrated.



COMPRESSED AIR INSTANTLY, Anywhere!!

Portable Air Compressor and storage tank, ruggedly built of best materials using lifetime lubricated ball-bearing on concentrated ball and oil impregnated main bearing on shaft. Pressure desired for or eliminates valve trouble. The most common fault in air compressors, PATENTED unique air intake system increases efficiency and automatically over-charge compressors so that air output is much greater than that from larger compressors. Possibility of breaker motors. Will deliver approximately 100 cu. inches of air per minute at maintained pressure of 30 lbs., or will inflate a 40 lb. truck tire in less than one minute. Comes complete with 400 lb. valve, which will automatically allow setting of output pressure at any 15 psi for spraying paints, lacquers, disinfectants, insecticides, emulsifiers or in the U.S. Efficient, completely adjustable siphon-type spray gun complete with 12 ft. of 100 lb. tested hose available for only \$7.75 with pint container, also prepaid. 25% required on all C.O.D. orders.



BUFFALO RADIO SUPPLY, 219-221 Genesee St., Dept. RE-12 BUFFALO 3, N. Y.

Buffalo Radio Supply
219-221 Genesee Street
Buffalo 3, New York

Please send 1949 Bargain Catalog.

Name

Address

City..... Zone..... State.....

hallicrafters
proudly
presents
the SX-62!



Communications-type
Broadcast Receiver
540 KC to 110 MC

\$289.59
(slightly
Higher West
of Rockies)

• For discriminating listeners on all wave bands (FM/AM) . . . who appreciate the thrill of superior performance . . . with high-fidelity audio . . . who want a few extra controls but not too many.

An "SWL" version of our famous SX-42. Two stages RF, three stages IF amplification—14 tubes plus Rectifier and Voltage Regulator. See it at your local Hallicrafters dealer.

the hallicrafters co.
4401 W. FIFTH AVENUE
CHICAGO 24, ILLINOIS

Headphone BARGAINS

Type HS23—8000-ohm impedance, highly sensitive . . . light-weight only 9 oz. Leather covered spring steel adjustable headband. 12' cord with PL54 plug attached at side out of way. Jack and rubber cord supplied to extend length to 5 1/2 feet. Removable rubber ear cushions. Brand New—\$13.50 Value.
Stk. No. 17A37
SPECIAL PER PAIR... \$2.45



Type HS30—8000 ohm impedance. Small yet highly sensitive. Built on hearing aid principle with ear fitting soft rubber cushions attached to receivers . . . shut out outside noise. Comfortable, light metal band easily shapes to contour of head. Supplied complete as illustrated with 6 foot cord and PL55 plug, shirt clip and matching transformer for 8000 ohm impedance. Very popular for conversion to mikes, telephone sets, miniature crystal sets and all ground-head-telephone use. Brand New... A Terrific Value!
No. 17A420X.
\$1.29
Per Pair

5BP4 CATHODE RAY TUBE \$2.95

Has 5" white screen. Quality make individually boxed in cushioned carton. Brand New, Perfect, Guaranteed. No. 36T206.
\$2.95
SPECIAL EACH

ORDER NOW from this ad—include postage.

FREE—the big NEW B-A Catalog No. 491, 132 pages of Outstanding Values. Write if you have not received it.

BURSTEIN-APPLEBEE
1012-14 MCGEE STREET,
KANSAS CITY 6, MISSOURI

H-F RECEIVER

? Please design for me a 32-mc receiver using a 6-volt transformer for filament power and a selenium-rectifier B-supply.—C. T. W., Jersey City, N. J.

A. The receiver shown in the diagram has high gain due to the regenerative 6L7 r.f. stage. If operation of the regeneration control does not make the set oscillate, reverse the connections of L3. The 20,000-ohm r.f. control acts as the volume control.

At 32 mc it may or may not be necessary to ground the lower end of the primary L1. Reception may be improved by connecting both ends of it to a doublet antenna.

For 32-mc operation, L2 and L4 consist of 10 turns of No. 14 solid-copper wire on a 1 1/4-inch-diameter form. The primaries L1 and L3 are five turns of No. 18 enameled wire interwound with the secondaries.

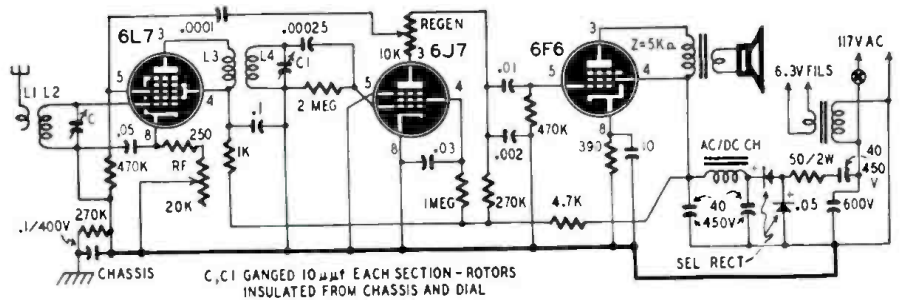

PHOTOFLASH UNIT

? Please show me how to build an electronic photoflash for photographic work. It should operate on either batteries or 117-volt house current.—R. H. A., Janesville, Wis.

A. The photoflash unit diagrammed operates on 117 volts a.c. or 4 volts d.c. Position 2 of the four-gang selector switch permits charging the batteries from the house current. Two small 2-volt storage cells should be used.

If only battery operation is desired, leave out the gang switch and use a s.p.s.t. on-off switch.

The batteries and power supply can be mounted in an insulated metal carrying case with handle and shoulder strap, and the flash lamp in the conventional-type holder and reflector. A three-wire cable is needed between the flash unit and the power supply. Be sure that the high-voltage lead is insulated for at least 5 kv for safety.

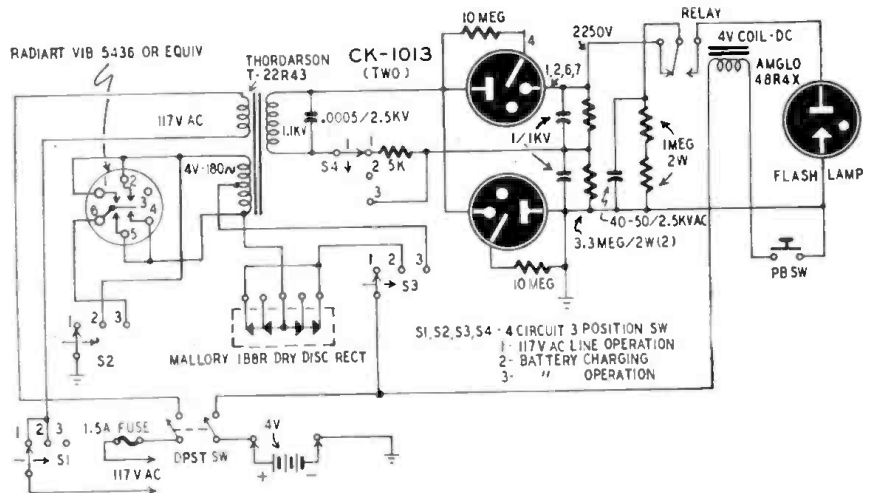

BC-455 CONVERSION

? I have a surplus BC-455-B receiver which I want to use on 10 meters. Please tell me how to rewind the coils.—S.W.P., Yakima, Wash.

A. First remove all wire from the antenna coil and substitute six turns of No. 18 enameled wire. Space the winding the full length of the form.

Remove all wire except the last layer from the plate coil of the 12SK7 r.f. tube. This should leave about nine turns.

Remove all wire from the 12K8 con-

verter signal grid coil (the one connected to the grid cap of the tube) and rewind with five turns of No. 18 enameled. Space it the full length of the form.

The coil connected to the first grid of the 12K8 is left as is. The coil to which it is coupled should be unwound and replaced with five turns of No. 18 enameled, unspaced.

From each section of the main tuning capacitor remove all rotor plates except two in each line. Leave the two right-hand plates (as viewed from the rear) on each section intact.

CAPITOL RADIO ENGINEERING INSTITUTE — Pioneer in Radio Engineering Instruction Since 1927

RADIO SERVICEMEN!

Train with one of
America's
Foremost
Technical
Institutes

**Practical New Home Study Course
Teaches You to Install & Service**

**TELEVISION and
FM RECEIVERS**

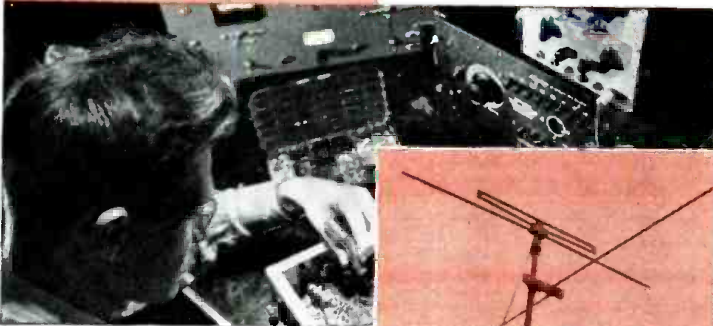

*CREI Training Can Help
You Earn More Money
Faster Because It Assumes
You Already Know
Radio Fundamentals*



IF TELEVISION installation and repair is over your head, before many months roll by you'll be as obsolete as a variable grid leak or a 201-A tube! The shop without qualified FM or TV repairmen might as well close up and sell apples . . . because the repair business will go to the men with ability to do a scientific servicing job on EVERY KIND of receiver. The most conservative estimates indicate that about 800,000 TV sets will be produced this year—and experts tell us that within 4 or 5 years there'll be some 11,000,000 in use. FM figures are equally impressive: there will be 4,000,000 more radios with FM as we enter 1949.

There are thousands of good radio repairmen who don't know a blanking pedestal from a kinescope. For them, and for the man with limited experience who has real ambition and inherent ability, CREI's new practical course in Television and FM Servicing can mean security and increased income. The course was developed by the experienced educators and technical men who have made CREI famous for home study and residence school radio-electronic training. It is designed to teach what you need to know to install and repair TV and FM sets. It won't make you a television engineer—it won't make you a million dollars overnight. But it will give you systematic methods for FM-TV installation and maintenance; knowledge of TV fundamentals; lessons in basic radio math, meters, lenses and mirrors, inductive coupling and condensers at ultra-high frequencies; practical application of resonant circuits; TV tubes; FM receiver alignment, TV antennae; picture synchronization; TV trouble-shooting—and much more.

Begin Training Now At Home

Put the knowledge you gain from each lesson to work immediately. The course has been tested—and proved in the field. It's intensely practical, designed for one purpose: to help a good radioman become a good TV-FM serviceman. Get complete details now.

MAIL TODAY!

CAPITOL RADIO ENGINEERING INSTITUTE
16th & Park Road, N. W., Dept. 5128, Washington 10, D. C.

Gentlemen:

Please send me complete details of your new home study course in Television and FM Servicing. I am attaching a brief resume of my experience, education and present position.

NAME _____

STREET _____

CITY _____

ZONE STATE _____

I AM ENTITLED TO TRAINING UNDER G. I. BILL.



RADIO SERVICE DIVISION OF

**CAPITOL RADIO
ENGINEERING INSTITUTE**

An Accredited Technical Institute

Dept. 5128, 16th & Park Road, N. W., Washington 10, D. C.

Branch Offices: N. Y. 7, 170 Broadway; San Francisco 2, 760 Market St.

DECEMBER, 1948

Transmission Lines

By ROBERT C. PAINE

ONLY \$89.50 IS THE COST!

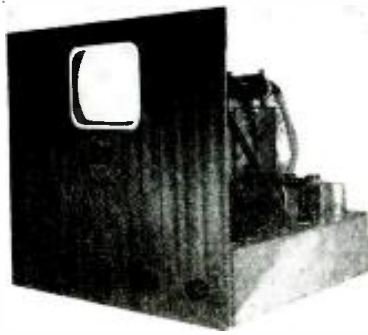

for the SENSATIONAL-NEW-IMPROVED 10 INCH TELEVISION KIT

Complete with new built-in pretuned and aligned 13 Channel tuner, all parts and easy step-by-step instructions and schematics.

\$89.50 less tubes

Kit, complete with all tubes\$149.50
Specially designed cabinet for kit 25.00

An amazing value! Even a beginner can assemble one of these fine, new improved television kits. Uses the new 13 channel tuner, prewired and factory aligned for the entire television spectrum. High quality parts and excellent circuit assure perfect performance. Circuit designed by outstanding T.V. engineers. Contains RF stage, oscillator and mixer. Uses new I.F. coils providing maximum gain and picture definition. Sound reception is high quality FM for years of listening pleasure.

Same quality and features for 7" KIT
Complete, less tubes\$59.50
Complete, with tubes 99.50
Specially designed cabinet for 7" kit 22.50
This kit can be used with Sylvania 10 HP4 10" picture tube without modifications.

7" and 10" KITS AVAILABLE FOR IMMEDIATE DELIVERY FROM STOCK!

The New Model B-45 Battery Operated SIGNAL GENERATOR

for servicing AM, FM and Television Receivers. R.F. frequencies from 150 Kilohertz to 50 Megacycles (150 Kc. to 12.5 Mc. on Fundamentals and from 11 Mc. to 50 Mc. on Harmonics). Complete with shielded test lead, self contained battery and instructions. NET.....\$27.75

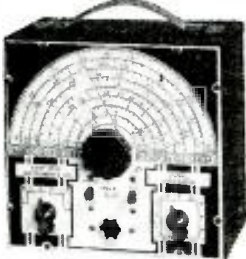

The New Model TC-50 TUBE AND SET TESTER

A complete laboratory, all purpose test-instrument, this versatile combination tube and set tester will accurately test all up-to-date designed tubes. The multi-meter section affords many necessary measurements for everyday's service work.

The New Model TC-50 Tube and Set Tester combines seven instruments, D.C.V., A.C.V., I.A., M.A., Ohms, Output Meter, Decibel Meter and Tube Tester. Full scale accuracy to 2%. English Reading GOOD and B.A.U. scale for testing tubes. Obsolescence reduced to absolute minimum. Simple and quick reading charts for tube testing. Multimeter section affords most popular everyday's measurements. Model TC-50 Tube and Set Tester operates on 90 120 Volts 60 cycles A.C. Housed in a sturdy beautiful portable, hand-rubbed cabinet. Complete with test leads, tube charts and all detailed, operating instructions. Size 8" x 10 1/2" x 5".....NET \$39.50

IMMEDIATE DELIVERY FROM STOCK

All orders filled same day received

Metropolitan ELECTRONIC & INSTRUMENT CO.
Dept RC12 42 WARREN ST. N. Y. 7, N. Y.

A TRANSMISSION line conveys power or communication signals from one point to another. It may be electrically "long" or "short." The "length" depends on the frequency and the wave length. At a power-line frequency of 60 cycles per second a wave length is approximately 300,000,000/60, or 5,000,000 meters long, roughly 3,000 miles. A radio frequency of 100 kc has a wave length of 3,000 meters.

The effects of reflection of waves begin to be barely noticeable on lines .01 wave length long and may become serious as 1/4 wave length is approached. So it may be said that a transmission line begins to be "long" when it is over .01 wave length.

At 10 kc a line would have to be over 300 meters long, nearly a quarter of a mile, before reflection effects could be noticed at all. So we see that at audio frequencies a line must be very long indeed to be a "long line." At 10 mc, however, a transmission line starts to be "long" when over 0.3 meter, although serious standing waves would not occur until it approached a length of about 6 meters. At 100 mc, in the middle of the new FM band, .01 wave length is only 3 cm, not much over an inch.

But in the ultra-high region, the merest scrap of wire becomes a "long line." So with greater activity on the higher frequencies, reflection becomes very important.

If the line is not properly terminated, electromagnetic waves are reflected from the distant end. The returning waves meet the waves from the generator in such a way as to add up at some points and subtract at others. This results in fixed points of high and low voltage and high and low current which are known as *standing waves*. (Reflection also occurs on short lines, but there is so little difference in phase between the outgoing and reflected waves that standing waves are negligible.)

Standing waves can be kept low or eliminated by proper line terminations and impedance-matching methods. Standing waves are harmful because they result in power losses due to heavy currents at certain points, which heat the conductors, and high voltages at other points, which increase the losses in the insulation. These standing-wave voltages can become high enough to break down the insulation.

Where standing waves exist, the impedance of the load as seen by the generator at the input end of the line varies with frequency and the length of the line. This interferes with proper loading of the generator. The load impedance should equal that of the generator at all times for greatest power

transfer. The impedance of a receiver should match that of the antenna, as seen at the input end of the transmission line, to get the greatest signal.

The conductors of a transmission line actually form a wave guide on which energy exists in the form of a traveling electromagnetic field. The electromagnetic field consists of an electric field between the conductors and a magnetic field encircling them. These fields extend indefinitely out into space; a portion of them is shown in Fig. 1. The solid lines

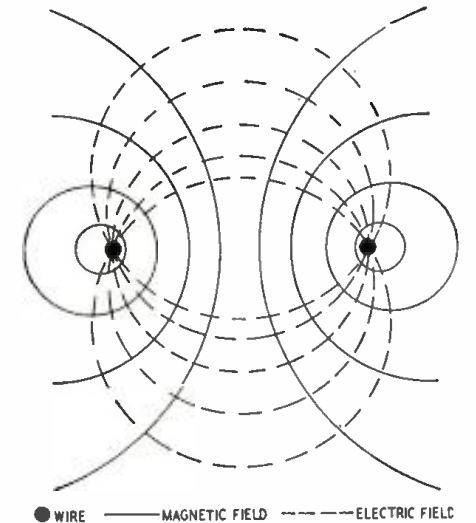

● WIRE ——— MAGNETIC FIELD - - - - - ELECTRIC FIELD

Fig. 1—End view of line and fields around it.

represent the magnetic field and the dashed lines the electric field. The line wires are shown in cross section.

On a line terminated by an *open circuit* the *magnetic* field collapses on reaching the open end of the wires, since the current flow is interrupted at that point. This sudden collapse of the field produces a reflected voltage wave of such polarity as to add to the initial wave, causing a *maximum of voltage* at the end of the line.

On a line terminated by a *short circuit*, the *electric* field collapses on reaching the end, since there can be no voltage across the short circuit. This produces a reflected current wave in such a direction as to add to the initial current, causing a *maximum of current* at the end of the line.

Fig. 2 shows the reflected waves of voltage (solid line) and current (dashed line) on an open-circuited line 13/18 wave length or 260 degrees long (one wave length is 360 electrical degrees). The current is zero at the open end of the line B, but the voltage is maximum there. At a quarter wave length (or 90 degrees) from the open end, the current is maximum and the voltage zero (for a no-loss line). At the generator

end of the line, the voltage is relatively low.

The effect of this length of line is to increase the voltage at the output to a much greater value than that at the input end, much as a tuned circuit (coil and condenser) multiplies voltage.

However, on a line with reflections, there may be several points at which maximum voltage appears, such as at A and B in Fig 2.

Fig. 3 shows a short-circuited line of the same length. Here the current is at a maximum and the voltage zero at the shorted end. This line results in an output current much greater than that at the input end. There is only a slight multiplication of the input voltage at the voltage peaks, since the input is connected at a point near a voltage peak. As shown, the input voltage of Fig. 3 is higher than in Fig. 2, yet the voltage peaks are of the same height.

Reflection of waves at the end of the line can be understood more easily by thinking of familiar low-frequency circuits. In the open-circuited line, consider the somewhat similar case of a coil in which current is flowing, with energy stored in the surrounding magnetic field. When the circuit is broken, collapse of the magnetic field causes energy to reappear as a momentarily increased voltage of a polarity which tends to cause current to flow in the same direction as before the circuit was broken, often causing a spark. Automobile ignition coils use this principle.

As a parallel to the example of the short-circuited line, consider the two charged plates of a condenser, in which energy is stored in the electric field. When the charged plates are connected together, the electric field collapses. Its energy reappears in the magnetic field of the current which flows momentarily from the positive to the negative plate. (One type of magnetizer for permanent

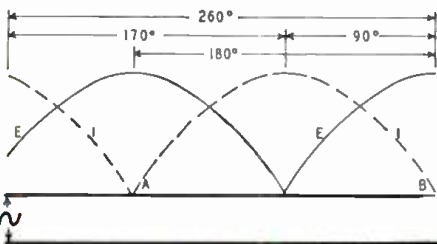

Fig. 2—Voltage and current on an open line.

this energy is almost instantly returned to the line, the wave is completely reflected.

The reflected wave can have any phase relation to the incident generated wave, depending on the type of terminating impedance, with different corresponding patterns of standing waves in which voltage and current maxima may occur at other points than those shown in Figs. 2 and 3.

To understand how standing waves can be eliminated, imagine a uniform transmission line extending to infinity. On such a line outgoing waves would never reach the distant end so there could be no reflection and no standing waves. The input voltage would have a constant ratio to the input current for any particular type of line. This ratio is a measure of input impedance because $Z = E/I$. Should sections be successively cut off the input end, the same impedance would appear at each new input end.

This is because the impedance of a transmission line is controlled by two factors—the inductance of the conductors, and the capacitance between them. Both these increase with increasing line length—but the increasing inductance increases the reactance of the line, while the increasing capacitance decreases it. So if (for example) the impedance of a 3-mile line were measured in three successive 1-mile sections, then the whole line measured, the four impedances would be the same. The whole line has the same impedance as a part of it. This impedance is known both as the iterative (literally “repeating”) impedance and also the characteristic or surge impedance.

Although such an infinite line is impossible, any uniform line can be terminated in a certain load impedance which eliminates standing waves and gives a constant input impedance regardless of line length. The line would appear at its input to be the same as an infinite line, and the impedance seen would be equal to its characteristic.

The characteristic impedance is usually designated Z_0 . This impedance—for low-loss radio transmission lines—is practically pure resistance, so it is sometimes designated R_0 . If a line is terminated in its characteristic impedance, the energy of the electromagnetic wave is completely absorbed by the load and no reflection takes place.

The input impedance of any trans-

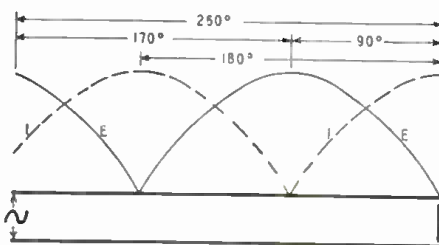

Fig. 3—Voltage and current on shorted line.

mission line is determined by the ratio of input voltage to input current. The input voltage shown in Fig. 2 is low and the current high, showing that the

LOOK FOR IT..

the

TELEVISION ASSEMBLY CO.

SPECIAL SECTION

in next month's issue

Something the SOUND MEN have been looking for for a long time

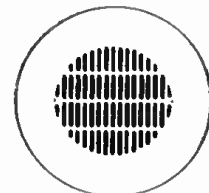

MODEL 10-P

A beautiful chrome plated flush mounting grille to accommodate a 6, 7 or 8" speaker

Write for literature

WRIGHT

Inc.

2234 University Ave.
St. Paul 4, Minn.

Are You Training For Television?

New TV receiver developments are easy to follow once you understand basic circuits and requirements for TV reception. Planned for a University Technical School, TELEVISION RECEIVER CONSTRUCTION by LEBSCHER is a most informative publication on building, testing, and troubleshooting TV receivers. . . many photos show production methods of progressive assembly. . . others picture reception results, antenna styles, soldering technique. Numbers of circuit diagrams to go with those on each part to show clearly set layout and alignment points. You can't afford to miss this book at a low low price of only \$1.00!



Also available for joint study: 16" x 24" factory size schematic blueprint with block diagram and alignment frequencies.

ELECTRONIC DEVELOPMENT COMPANY OF PA.
7618 Fayette Street, Philadelphia 38, Pennsylvania

\$1.00 for TELEVISION RECEIVER CONSTRUCTION, postpaid, 7¢ \$1.00 for Blueprint schematic, postpaid.
Print your name and address clearly.

ARE YOU A DIAL JOCKEY?



No need to "ride" your tuning dial with a Craftsman AUT-O-LOK tuner. With AUT-O-LOK you get your station at only one dial setting — easily, quickly and positively and it's locked against drifting.

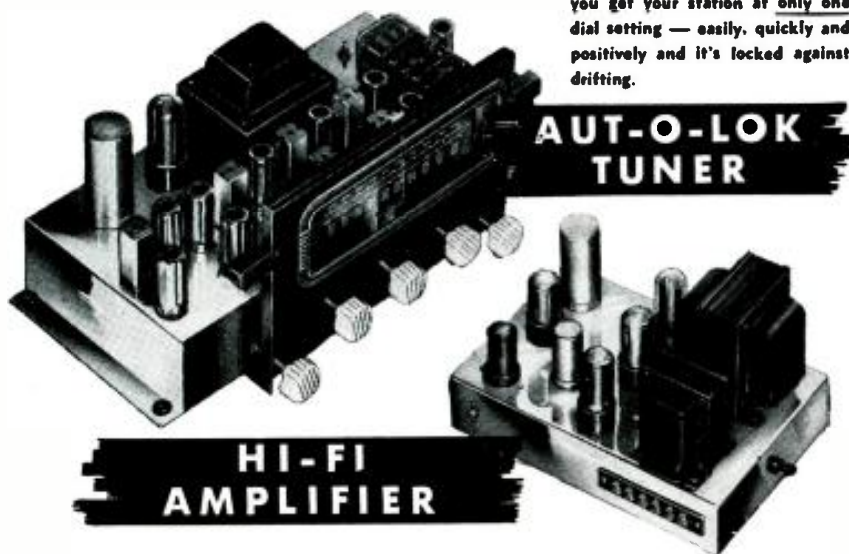

FM-AM TUNER RC-8. Features automatic frequency control, most revolutionary development in FM design — entirely eliminates drift and multiple tuning responses. Nine shielded miniature tubes plus rectifier include double limiter and tuned RF stage in both FM and AM. Low-impedance loop, enabling flexibility in mounting, provides low-noise AM reception. Rear socket provides easy access to 6.3-volt AC and exceptionally well-filtered DC for supplying external pre-amplifiers, additional pilot lights, etc. Controls include separate bass, treble and switch positions for phonograph and

television audio inputs. Polished chrome chassis. Audio cable, escutcheon, decals, antennae, and detailed installation instructions furnished.

HI-FIDELITY AMPLIFIER RC-2. High-impedance input: 12 watts output at 1% distortion. Taps: 4, 6, 8, 15, 500 ohms. 65 db gain, including inverse feedback. Uniform frequency response from 20 to 20,000 cycles up to 8 watts output. Hum 65 db below rated output. Tubes: 6J5, 6SN7, (2) 6V6, 5Y3. Durable polished chrome chassis.

Sold by Better Distributors. Write for Circular "B"

The RADIO CRAFTSMEN, Inc.
1341 S. MICHIGAN AVENUE, CHICAGO 5, ILL.

input impedance is low. But in Fig. 3 the input voltage is high and the current low, indicating a high input impedance for the same length of line but with a different termination. By selecting lengths between 180 and 270 degrees, the impedance of either the open line of Fig. 2 or the shorted line of Fig. 3 may be made to vary from a very low to a very high value, the impedance of the open line being greatest at 180, and that of the shorted line at 270 (or 90) degrees.

When a transmission line is terminated by any impedance other than its characteristic one, its input impedance varies with the length of the line and the frequency. The formulas are rather complex. So it is generally more convenient to calculate input impedance

by means of some of the various charts available*.

The characteristic impedance of air-spaced parallel-wire lines depends on the diameter d of the wires and the center-to-center distance D between them. Z_0 in ohms = $276 \log_{10} 2D/d$. Values of Z_0 for various sizes of wire and spacing are shown in Fig. 4. For concentric lines (air-spaced), $Z_0 = 138 \log_{10} D/d$, where d is the diameter of the inner conductor and D is the inner diameter of the outer conductor or sheath. Values for various ratios are shown in Fig. 5.

There are many types of transmission lines. Parallel wires supported by

insulators are used where relatively high impedance is desired. A ribbon type consisting of two parallel wires spaced by a flexible dielectric is used for lower impedances. These lines have standardized values such as 75, 150, and 300 ohms. Parallel lines are subject to some extent to interfering external voltages. Co-axial lines are much more completely shielded from interference by the outer conductor. Common impedance values for the solid-dielectric co-axial lines are 52 and 75 ohms.

The conductors of parallel lines are

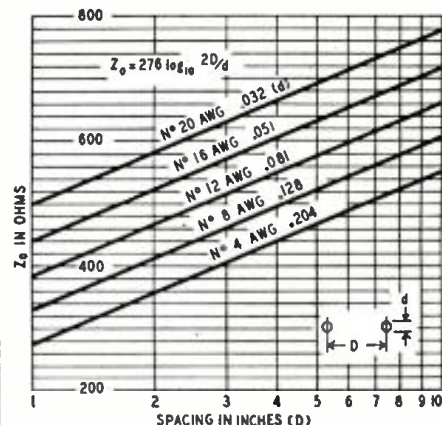

Fig. 4—Impedance values of parallel lines.

balanced to ground; the conductors of co-axial lines are unbalanced. When co-axial lines are connected to parallel lines or balanced loads, it is necessary to take special measures to maintain balance. In transmission lines where the conductors are separated by a continuous dielectric other than air, the speed of transmitted waves becomes somewhat less than that in air and the wave length is from 5% to 20% less. The correct values are furnished by the various manufacturers.

There are various methods of matching the impedance of the load to the line to eliminate or reduce standing

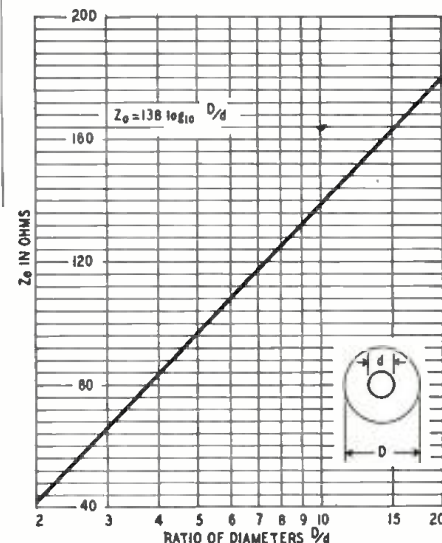
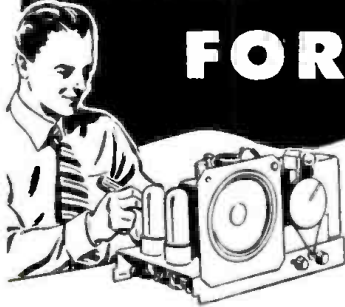

Fig. 5—Impedance chart for concentric lines.

waves. There are also circuits in which standing waves can be useful. These will be discussed in subsequent articles.

HOW'D YOU LIKE TO GET these famous Ghirardi Training Course Books FOR CHRISTMAS?



Friends or relatives are probably wondering what to give YOU this Christmas. Then why not drop a hint that nothing would please you more than Ghirardi Radio-Electronic training course books? They'll appreciate the suggestion—and you'll appreciate the books every day of your life. What finer gift could you ever hope to receive than these giant training books that make it easy as A-B-C to learn basic Radio-Electronics and to troubleshoot and repair all kinds of radio and electronic equipment? And why not give these big books for Christmas to your friends who are interested in radio?

BEGINNERS! LEARN BASIC RADIO-ELECTRONICS

as fast as you can read!



No matter what phase of Radio or Electronic work you'd like to specialize in, you'll need the basic training that Ghirardi's 4 1/2 lb., 972-page RADIO PHYSICS COURSE book gives. More people have gotten their start from this giant book than any other book or course! On a survey among hundreds of radio service experts, engineers, instructors, etc., 9 out of 10 said that Ghirardi's RADIO PHYSICS COURSE is the finest, easiest to understand Radio-Electronic Training Course on the market. And you buy it for only \$5 for the complete course—on a money-back guarantee basis!

The most widely used radio training book in the world

Only \$5 for the entire course.

LEARN FAST!
LEARN RIGHT!

36 COURSES IN ONE!

RADIO PHYSICS COURSE is especially written for home study without an instructor. Nothing is omitted or condensed. Starting with a thorough, easily-understood foundation course in Basic Electricity, the book takes you step by step through the entire field of basic Radio-Electronics. Actually, RADIO PHYSICS COURSE gives you the scope of 36 complete courses in one big book. If broken into sections and sold as a series of lessons, you'd regard it as a bargain at \$30 or more. But you get it all at once! You learn as fast as you can read. Subjects that seem highly complicated in other courses are made crystal clear both in text and by over 508 clear pictures and diagrams. Mail order today. Remember, you don't really risk a cent. OUR 10-DAY EXAMINATION POLICY PROTECTS YOU FULLY!

LEARN TO REPAIR RADIOS THIS FAST, EASY WAY!

You don't have to be an expert to make ordinary repairs in 4 RADIOS OUT OF 5! You don't need a lot of high-priced test equipment! Every receiver has its "weak" spots that give trouble first. Ghirardi has compiled case histories of these common troubles into a big 744-page RADIO TROUBLESHOOTER'S HANDBOOK. When you want to repair a set, just look up its make and model number. 4 times out of 5 the book tells you what the trouble is—and exactly how to fix it with a few simple tools. It's a service short cut that really works. The book pays for itself in time saved THE FIRST TIME YOU USE IT. Smart servicemen use it on every job.

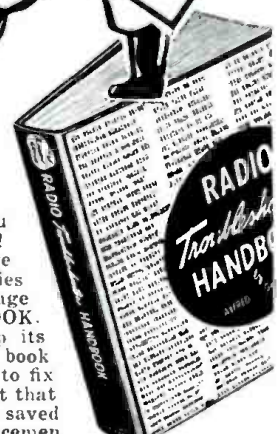

DO TWO JOBS... IN THE TIME NORMALLY REQUIRED FOR ONE!

RADIO TROUBLESHOOTER'S HANDBOOK tells you what to do and exactly how to do it in repairing practically every radio model in use today. And that is just the beginning. It also contains the most complete, genuinely helpful Tube Chart you've ever seen. Dozens of pages contain I-F alignment peaks for over 20,000 superhets and data on I-F transformer troubles. Hundreds of additional pages contain tables, graphs, charts and service information to help you repair any radio ever made easier. AND TWICE AS FAST! You get the complete, manual-size book for only \$5. See money-saving offer below!

Let this "AUTOMATIC TEACHER"

show you exactly how to repair OVER 4800 RADIO MODELS

Fix Radios Without Costly Test Equipment

Get a complete PROFESSIONAL RADIO SERVICE TRAINING

At Home Without An Instructor



Ghirardi's famous 1300-page MODERN RADIO SERVICING is a complete, 1-volume course in PROFESSIONAL service methods of the kind that open doors to big money opportunities which only scientifically-trained men can grasp. It shows how to avoid guesswork by analyzing radio and other electronic circuits by professional methods. Explains how all basic types of radio test instruments work. Tells when, why, where and exactly how to use them. Shows how to troubleshoot both circuits and complete equipment; how to make repairs and replacements; how to analyze components—even how to run a successful radio service business of your own.

Trouble Shooting Instruments and repair

MODERN RADIO SERVICING is invaluable as a "refresher" course for men already in the radio service business—and it's worth its weight in gold to service beginners! Everything is explained so clearly it can easily be understood at home without an instructor. 706 clear illustrations and 720 Self-Test Review Questions speed up learning. Only \$5 for the big 4 lb. book—on our 10-DAY FREE EXAMINATION OFFER. See money-saving offer in coupon.

Makes the hard jobs easy to do!

Trains You Scientifically for All Phases of Radio-Electronic Service.

MONEY SAVING SPECIAL OFFER!

Let Ghirardi's RADIO TROUBLESHOOTER'S HANDBOOK save you time and money on common service jobs. Let his MODERN RADIO SERVICING train you for professional service work of all kinds! Get BOTH big books for only \$9.50 (\$10.50 foreign.) See Money-Saving Offer in coupon.

10-DAYS' FREE EXAMINATION COUPON

Dept. RE-128, Murray Hill Books, Inc.
232 Madison Ave., New York 16, N. Y.

Send me the books checked below for 10 days' examination on approval. In 10 days, I will either pay for the books plus a few cents postage, or return them to you postpaid. (Postage paid on cash orders; same return privilege.) (Books sent on approval in U.S.A. only.)

- RADIO PHYSICS COURSE, \$5 (\$5.50 outside U.S.)
- MODERN RADIO SERVICING, \$5 (\$5.50 outside U.S.)
- RADIO TROUBLESHOOTER'S HANDBOOK, \$5 (\$5.50 outside U.S.)
- MONEY SAVING COMBINATION: Both Modern Radio Servicing and Radio Troubleshooter's Handbook, only \$9.50 for the two (\$10.50 outside U.S.)

Name

Address

City and Zone State



HEARING AID MINIATURE PARTS!!

BONE CONDUCTION RECEIVER — Famous make. Attracting miniature type. Low input. Makes excellent Pillow or Miniature Speaker; or Contact Mike. Plastic housing. 1 1/2" x 3/4" x 1 1/2". 2.95
4 for 9.95

HEARING AID AMPLIFIER ASSEMBLY — Vacuum tube amplifier type (CK-91, 502). Make a Real Vial Pocket Radio, adding only tuner coil, & speaker or phone. Ready-wired miniature components include 2 control dials & 1 meter, dials, chokes, output trans., switch, resistors, condensers, etc. Complete with Schematic Diagrams for Building a 2 or 3 Tube Set. Less tubes & case. Overall: 2" x 3/4" x 3/4". **WEIGHTS 2.49**
ONLY 3 1/2 ozs.

MINIATURE ALNICO V MAGNETIC PHONE UNIT — Hi fidelity for use with above Hearing Aid Amplifier as PM or Pillow Speaker. Makes sensitive Magnetic or Contact Mike. 3/4" O.D., 1 1/2" deep. .39

"BOUNCER" OUTPUT TRANSFORMER (1 1/2" x 1 1/2" x 2 1/2") with tapped double primary to voice coil. Excellent with Beam Power tubes (6X4, 6X5, etc.). 49
12 for 5.00

3:1 AUDIO TRANSFORMER — 100 resist. 500 700. Thermally sealed. 2" x 1 1/2" x 1 1/2". 69c—2 for 1.25

RCA VICTOR POWER TRANSFORMER for models R-32, 35, 52 or 75. Unshielded. \$5.95
Ship. wt. 7 lbs.

MINIATURE SOCKET MTG. PLATES — For mtg. mini-sockets in standard large socket hole. ea. .03—10 for .25

TUBE CARTONS Plain White
Miniature (1 1/2" sq. x 2 1/2") Per 100 .98
GT size (1 1/2" sq. x 2 1/2") Per 100 1.25
Medium (1 1/2" sq. x 4 1/2") Per 100 1.49
Large (2" sq. x 3") Per 100 1.79

RECORDING PARTS SPECIALS—RM-1 RECORDING MOTOR. Heavy duty. 110V. 50 cycles. Silent operating for WIRE TAPE or DISC RECORDING & PLAYBACK. 3 1/2" sq. x 2 1/2". Less turntable, mtg. plate & reduction drive wheel. Ship. wt. 4.95
6 lbs.

Special for the Month!



RADIO-AMPLIFIER STEEL CABINETS

This handsome, multi-use cabinet will beautify any RADIO or ELECTRONIC EQUIPMENT. COMPLETE POWER SUPPLY, TEST EQUIPMENT, MEDICAL APPARATUS, ETC. Sloping dial 16 1/2" x 1 1/2". Overall: 16 1/2" x 9 1/2" x 10 1/2". Rubber bumper feet. Ship. wt. 10 lbs. **BRAND NEW—ONLY 1.59**

LEOTONE Announces!

BIG NEWS!!!
FOR RADIOMEN! ELECTRICIANS! STUDENTS!



Cash in Now—Repair all types of Electrical Appliances, Motors & many other popular items with the new

"LEOTONE UTILITY TESTER"

Here is a PROFITABLE fertile field you can ENTER NOW with a tester of this kind. TROUBLE-SHOOTING AND REPAIR MADE EASY ON: TOASTERS HEATERS AIR CONDITIONERS REFRIGERATORS SHAVERS WASHING MACHINES VACUUM CLEANERS

MOTORS OF EVERY TYPE

Ranges: AC Volts 25 & 125—DC Volts 10, 50 & 250; Current—20 MA; Resistance 0-50,000 ohms.

- FEATURES:**
- Simplified Range Selection.
 - Large 4" industrial fan type meter. Instantly convertible and with Hi-Torque Movement for superior performance.
 - Will test: Fuses, Condensers, Resistors, Line Coils, Field Coils, Switches, Controls, etc., etc.
 - Excellent TROUBLE-SHOOTER—Instantly locating shorts, opens and grounds.
 - Will indicate: Excessive Leakage, Blown Fuses, Line Voltage, AC or DC Current, etc.

The **LEOTONE UTILITY TESTER** comes complete with test leads and operating instructions. Housed in a black crackle finish steel portable case with hinged lid. Now ONLY **12.95**
In Kit Form—easy to assemble, complete with instructions. Shipping wt. 5 lbs. **11.45**
ONLY



MAKERS OF CONES AND FIELD COILS
65-67 DEY STREET, NEW YORK 7, N.Y.
WORTH 2-0284-5
12,000 SQ. FT. OF RADIO PARTS

6 TUBE CHASSIS to fit above cabinet. Cadmium plated steel. All necessary mtg. holes cut. 500g. 3 1/2 lbs. .49c
COMPLETE FOUNDATION OF CABINET & CHASSIS 1.98

MORE TUBES AT NEW LOW PRICES!!

STOCK UP NOW at up to 80% off list. Perfect condition. GUARANTEED FOR 90 DAYS! Unused tubes: 27, 35, 37, 39, 77, 81, 85, 92, 94, 95, 96, 97, 98, 99, 100, 101, 102, 103, 104, 105, 106, 107, 108, 109, 110, 111, 112, 113, 114, 115, 116, 117, 118, 119, 120, 121, 122, 123, 124, 125, 126, 127, 128, 129, 130, 131, 132, 133, 134, 135, 136, 137, 138, 139, 140, 141, 142, 143, 144, 145, 146, 147, 148, 149, 150, 151, 152, 153, 154, 155, 156, 157, 158, 159, 160, 161, 162, 163, 164, 165, 166, 167, 168, 169, 170, 171, 172, 173, 174, 175, 176, 177, 178, 179, 180, 181, 182, 183, 184, 185, 186, 187, 188, 189, 190, 191, 192, 193, 194, 195, 196, 197, 198, 199, 200, 201, 202, 203, 204, 205, 206, 207, 208, 209, 210, 211, 212, 213, 214, 215, 216, 217, 218, 219, 220, 221, 222, 223, 224, 225, 226, 227, 228, 229, 230, 231, 232, 233, 234, 235, 236, 237, 238, 239, 240, 241, 242, 243, 244, 245, 246, 247, 248, 249, 250, 251, 252, 253, 254, 255, 256, 257, 258, 259, 260, 261, 262, 263, 264, 265, 266, 267, 268, 269, 270, 271, 272, 273, 274, 275, 276, 277, 278, 279, 280, 281, 282, 283, 284, 285, 286, 287, 288, 289, 290, 291, 292, 293, 294, 295, 296, 297, 298, 299, 300, 301, 302, 303, 304, 305, 306, 307, 308, 309, 310, 311, 312, 313, 314, 315, 316, 317, 318, 319, 320, 321, 322, 323, 324, 325, 326, 327, 328, 329, 330, 331, 332, 333, 334, 335, 336, 337, 338, 339, 340, 341, 342, 343, 344, 345, 346, 347, 348, 349, 350, 351, 352, 353, 354, 355, 356, 357, 358, 359, 360, 361, 362, 363, 364, 365, 366, 367, 368, 369, 370, 371, 372, 373, 374, 375, 376, 377, 378, 379, 380, 381, 382, 383, 384, 385, 386, 387, 388, 389, 390, 391, 392, 393, 394, 395, 396, 397, 398, 399, 400, 401, 402, 403, 404, 405, 406, 407, 408, 409, 410, 411, 412, 413, 414, 415, 416, 417, 418, 419, 420, 421, 422, 423, 424, 425, 426, 427, 428, 429, 430, 431, 432, 433, 434, 435, 436, 437, 438, 439, 440, 441, 442, 443, 444, 445, 446, 447, 448, 449, 450, 451, 452, 453, 454, 455, 456, 457, 458, 459, 460, 461, 462, 463, 464, 465, 466, 467, 468, 469, 470, 471, 472, 473, 474, 475, 476, 477, 478, 479, 480, 481, 482, 483, 484, 485, 486, 487, 488, 489, 490, 491, 492, 493, 494, 495, 496, 497, 498, 499, 500, 501, 502, 503, 504, 505, 506, 507, 508, 509, 510, 511, 512, 513, 514, 515, 516, 517, 518, 519, 520, 521, 522, 523, 524, 525, 526, 527, 528, 529, 530, 531, 532, 533, 534, 535, 536, 537, 538, 539, 540, 541, 542, 543, 544, 545, 546, 547, 548, 549, 550, 551, 552, 553, 554, 555, 556, 557, 558, 559, 560, 561, 562, 563, 564, 565, 566, 567, 568, 569, 570, 571, 572, 573, 574, 575, 576, 577, 578, 579, 580, 581, 582, 583, 584, 585, 586, 587, 588, 589, 590, 591, 592, 593, 594, 595, 596, 597, 598, 599, 600, 601, 602, 603, 604, 605, 606, 607, 608, 609, 610, 611, 612, 613, 614, 615, 616, 617, 618, 619, 620, 621, 622, 623, 624, 625, 626, 627, 628, 629, 630, 631, 632, 633, 634, 635, 636, 637, 638, 639, 640, 641, 642, 643, 644, 645, 646, 647, 648, 649, 650, 651, 652, 653, 654, 655, 656, 657, 658, 659, 660, 661, 662, 663, 664, 665, 666, 667, 668, 669, 670, 671, 672, 673, 674, 675, 676, 677, 678, 679, 680, 681, 682, 683, 684, 685, 686, 687, 688, 689, 690, 691, 692, 693, 694, 695, 696, 697, 698, 699, 700, 701, 702, 703, 704, 705, 706, 707, 708, 709, 710, 711, 712, 713, 714, 715, 716, 717, 718, 719, 720, 721, 722, 723, 724, 725, 726, 727, 728, 729, 730, 731, 732, 733, 734, 735, 736, 737, 738, 739, 740, 741, 742, 743, 744, 745, 746, 747, 748, 749, 750, 751, 752, 753, 754, 755, 756, 757, 758, 759, 760, 761, 762, 763, 764, 765, 766, 767, 768, 769, 770, 771, 772, 773, 774, 775, 776, 777, 778, 779, 780, 781, 782, 783, 784, 785, 786, 787, 788, 789, 790, 791, 792, 793, 794, 795, 796, 797, 798, 799, 800, 801, 802, 803, 804, 805, 806, 807, 808, 809, 810, 811, 812, 813, 814, 815, 816, 817, 818, 819, 820, 821, 822, 823, 824, 825, 826, 827, 828, 829, 830, 831, 832, 833, 834, 835, 836, 837, 838, 839, 840, 841, 842, 843, 844, 845, 846, 847, 848, 849, 850, 851, 852, 853, 854, 855, 856, 857, 858, 859, 860, 861, 862, 863, 864, 865, 866, 867, 868, 869, 870, 871, 872, 873, 874, 875, 876, 877, 878, 879, 880, 881, 882, 883, 884, 885, 886, 887, 888, 889, 890, 891, 892, 893, 894, 895, 896, 897, 898, 899, 900, 901, 902, 903, 904, 905, 906, 907, 908, 909, 910, 911, 912, 913, 914, 915, 916, 917, 918, 919, 920, 921, 922, 923, 924, 925, 926, 927, 928, 929, 930, 931, 932, 933, 934, 935, 936, 937, 938, 939, 940, 941, 942, 943, 944, 945, 946, 947, 948, 949, 950, 951, 952, 953, 954, 955, 956, 957, 958, 959, 960, 961, 962, 963, 964, 965, 966, 967, 968, 969, 970, 971, 972, 973, 974, 975, 976, 977, 978, 979, 980, 981, 982, 983, 984, 985, 986, 987, 988, 989, 990, 991, 992, 993, 994, 995, 996, 997, 998, 999, 1000, 1001, 1002, 1003, 1004, 1005, 1006, 1007, 1008, 1009, 1010, 1011, 1012, 1013, 1014, 1015, 1016, 1017, 1018, 1019, 1020, 1021, 1022, 1023, 1024, 1025, 1026, 1027, 1028, 1029, 1030, 1031, 1032, 1033, 1034, 1035, 1036, 1037, 1038, 1039, 1040, 1041, 1042, 1043, 1044, 1045, 1046, 1047, 1048, 1049, 1050, 1051, 1052, 1053, 1054, 1055, 1056, 1057, 1058, 1059, 1060, 1061, 1062, 1063, 1064, 1065, 1066, 1067, 1068, 1069, 1070, 1071, 1072, 1073, 1074, 1075, 1076, 1077, 1078, 1079, 1080, 1081, 1082, 1083, 1084, 1085, 1086, 1087, 1088, 1089, 1090, 1091, 1092, 1093, 1094, 1095, 1096, 1097, 1098, 1099, 1100, 1101, 1102, 1103, 1104, 1105, 1106, 1107, 1108, 1109, 1110, 1111, 1112, 1113, 1114, 1115, 1116, 1117, 1118, 1119, 1120, 1121, 1122, 1123, 1124, 1125, 1126, 1127, 1128, 1129, 1130, 1131, 1132, 1133, 1134, 1135, 1136, 1137, 1138, 1139, 1140, 1141, 1142, 1143, 1144, 1145, 1146, 1147, 1148, 1149, 1150, 1151, 1152, 1153, 1154, 1155, 1156, 1157, 1158, 1159, 1160, 1161, 1162, 1163, 1164, 1165, 1166, 1167, 1168, 1169, 1170, 1171, 1172, 1173, 1174, 1175, 1176, 1177, 1178, 1179, 1180, 1181, 1182, 1183, 1184, 1185, 1186, 1187, 1188, 1189, 1190, 1191, 1192, 1193, 1194, 1195, 1196, 1197, 1198, 1199, 1200, 1201, 1202, 1203, 1204, 1205, 1206, 1207, 1208, 1209, 1210, 1211, 1212, 1213, 1214, 1215, 1216, 1217, 1218, 1219, 1220, 1221, 1222, 1223, 1224, 1225, 1226, 1227, 1228, 1229, 1230, 1231, 1232, 1233, 1234, 1235, 1236, 1237, 1238, 1239, 1240, 1241, 1242, 1243, 1244, 1245, 1246, 1247, 1248, 1249, 1250, 1251, 1252, 1253, 1254, 1255, 1256, 1257, 1258, 1259, 1260, 1261, 1262, 1263, 1264, 1265, 1266, 1267, 1268, 1269, 1270, 1271, 1272, 1273, 1274, 1275, 1276, 1277, 1278, 1279, 1280, 1281, 1282, 1283, 1284, 1285, 1286, 1287, 1288, 1289, 1290, 1291, 1292, 1293, 1294, 1295, 1296, 1297, 1298, 1299, 1300, 1301, 1302, 1303, 1304, 1305, 1306, 1307, 1308, 1309, 1310, 1311, 1312, 1313, 1314, 1315, 1316, 1317, 1318, 1319, 1320, 1321, 1322, 1323, 1324, 1325, 1326, 1327, 1328, 1329, 1330, 1331, 1332, 1333, 1334, 1335, 1336, 1337, 1338, 1339, 1340, 1341, 1342, 1343, 1344, 1345, 1346, 1347, 1348, 1349, 1350, 1351, 1352, 1353, 1354, 1355, 1356, 1357, 1358, 1359, 1360, 1361, 1362, 1363, 1364, 1365, 1366, 1367, 1368, 1369, 1370, 1371, 1372, 1373, 1374, 1375, 1376, 1377, 1378, 1379, 1380, 1381, 1382, 1383, 1384, 1385, 1386, 1387, 1388, 1389, 1390, 1391, 1392, 1393, 1394, 1395, 1396, 1397, 1398, 1399, 1400, 1401, 1402, 1403, 1404, 1405, 1406, 1407, 1408, 1409, 1410, 1411, 1412, 1413, 1414, 1415, 1416, 1417, 1418, 1419, 1420, 1421, 1422, 1423, 1424, 1425, 1426, 1427, 1428, 1429, 1430, 1431, 1432, 1433, 1434, 1435, 1436, 1437, 1438, 1439, 1440, 1441, 1442, 1443, 1444, 1445, 1446, 1447, 1448, 1449, 1450, 1451, 1452, 1453, 1454, 1455, 1456, 1457, 1458, 1459, 1460, 1461, 1462, 1463, 1464, 1465, 1466, 1467, 1468, 1469, 1470, 1471, 1472, 1473, 1474, 1475, 1476, 1477, 1478, 1479, 1480, 1481, 1482, 1483, 1484, 1485, 1486, 1487, 1488, 1489, 1490, 1491, 1492, 1493, 1494, 1495, 1496, 1497, 1498, 1499, 1500, 1501, 1502, 1503, 1504, 1505, 1506, 1507, 1508, 1509, 1510, 1511, 1512, 1513, 1514, 1515, 1516, 1517, 1518, 1519, 1520, 1521, 1522, 1523, 1524, 1525, 1526, 1527, 1528, 1529, 1530, 1531, 1532, 1533, 1534, 1535, 1536, 1537, 1538, 1539, 1540, 1541, 1542, 1543, 1544, 1545, 1546, 1547, 1548, 1549, 1550, 1551, 1552, 1553, 1554, 1555, 1556, 1557, 1558, 1559, 1560, 1561, 1562, 1563, 1564, 1565, 1566, 1567, 1568, 1569, 1570, 1571, 1572, 1573, 1574, 1575, 1576, 1577, 1578, 1579, 1580, 1581, 1582, 1583, 1584, 1585, 1586, 1587, 1588, 1589, 1590, 1591, 1592, 1593, 1594, 1595, 1596, 1597, 1598, 1599, 1600, 1601, 1602, 1603, 1604, 1605, 1606, 1607, 1608, 1609, 1610, 1611, 1612, 1613, 1614, 1615, 1616, 1617, 1618, 1619, 1620, 1621, 1622, 1623, 1624, 1625, 1626, 1627, 1628, 1629, 1630, 1631, 1632, 1633, 1634, 1635, 1636, 1637, 1638, 1639, 1640, 1641, 1642, 1643, 1644, 1645, 1646, 1647, 1648, 1649, 1650, 1651, 1652, 1653, 1654, 1655, 1656, 1657, 1658, 1659, 1660, 1661, 1662, 1663, 1664, 1665, 1666, 1667, 1668, 1669, 1670, 1671, 1672, 1673, 1674, 1675, 1676, 1677, 1678, 1679, 1680, 1681, 1682, 1683, 1684, 1685, 1686, 1687, 1688, 1689, 1690, 1691, 1692, 1693, 1694, 1695, 1696, 1697, 1698, 1699, 1700, 1701, 1702, 1703, 1704, 1705, 1706, 1707, 1708, 1709, 1710, 1711, 1712, 1713, 1714, 1715, 1716, 1717, 1718, 1719, 1720, 1721, 1722, 1723, 1724, 1725, 1726, 1727, 1728, 1729, 1730, 1731, 1732, 1733, 1734, 1735, 1736, 1737, 1738, 1739, 1740, 1741, 1742, 1743, 1744, 1745, 1746, 1747, 1748, 1749, 1750, 1751, 1752, 1753, 1754, 1755, 1756, 1757, 1758, 1759, 1760, 1761, 1762, 1763, 1764, 1765, 1766, 1767, 1768, 1769, 1770, 1771, 1772, 1773, 1774, 1775, 1776, 1777, 1778, 1779, 1780, 1781, 1782, 1783, 1784, 1785, 1786, 1787, 1788, 1789, 1790, 1791, 1792, 1793, 1794, 1795, 1796, 1797, 1798, 1799, 1800, 1801, 1802, 1803, 1804, 1805, 1806, 1807, 1808, 1809, 1810, 1811, 1812, 1813, 1814, 1815, 1816, 1817, 1818, 1819, 1820, 1821, 1822, 1823, 1824, 1825, 1826, 1827, 1828, 1829, 1830, 1831, 1832, 1833, 1834, 1835, 1836, 1837, 1838, 1839, 1840, 1841, 1842, 1843, 1844, 1845, 1846, 1847, 1848, 1849, 1850, 1851, 1852, 1853, 1854



CROSS POINTER INDICATOR

Dual 0-200 microamp. movement in 3" case. Each movement brought out to 6 term receptacle at rear. Originally used in ILS equipment. New \$5.50

INSTRUCTION MANUALS

- RC 312, RC 312 \$1.25
- SCR 281 \$1.25 Mark II 1.00
- ZA Form. 1.00 SCR 508 1.00
- SX-32 1.00

VIBRATORS

- TR 1210, 12 vdc, 5 pin \$1.20
 - OAK V-3675, 21-32 vdc, 7 pin 1.10
 - Mal. Type G331C, 12 vdc, 5 pin 1.25
 - Mal. Type G329C, 12 vdc, 4 pin 1.15
 - Radiant VB-2, 6 v. DC, 6 pin special 1.40
- Mfrs. quantities in all types available.

XMTR TUNING UNITS

For RC 610; TU 48 (2.5-3 mc); TU 47 (2-2.5 mc); TU 53 (8-12 mc). Each \$1.75
 For RC 228A; TU 17 (2.3 mc); TU 18 (3.4-5 mc). Each \$1.95
 RC 306-A, Antenna Loading unit for RC 375 & RC 191 \$2.75
 6-section ceramic capacitor, 10-400 mmf., 400 vdc, originally used for Collins ART-13 Xmtr. \$.69

SCR 610 11-10 METER PORTABLE/MOBILE RIG

SCR 610 portable transmitter-receiver, 27 to 38.0 mc, crystal controlled, using FM for efficient operation. Unit consists of Xmitter-RC 659 and power supply PE 97, operating from 6 or 12 vdc. Slightly used, excellent condition. Less X'tals. \$25.00

ROTARY BEAM CONTACTOR ASSEMBLY

6 Heavy duty Contact Rinks, 1 1/2" wide, 3 1/2" diam, mounted on low-loss form with bearing to fit 1 1/2" diam shaft. An excellent unit for feeding the beam. Each ring is brought out to a separate pin. New \$5.45 ea.

VFO KIT FOR 80 METERS

ARC-5 Xmit. M.O. parts and circuits for that new VFO-exciter. Kit consists of the following: #6029 M.O. coil; 1 #5632 tuning condenser; 1 #4990 padding cap; 1 #ARC-5 Xmit. Schematic. Complete kit \$2.75

DYNAMOTORS

Type	Input Volts	Input Amps	Output Volts	Output Amps	Radio Set	Price*
BD 77KM	14	40	1000	.350	10" 191	\$20.00 N
PE 73	28	19	1000	.350	RC 375	\$11.00 LN
DM 21	14	3.3	235	.000	10" 312	\$21.50 N
DM 21CX	14	1.5	235	.000	10" 312	\$3.15 N
DM 25	12	2.3	250	.050	10" 367	\$2.19 LN
DM 28R	28	1.25	275	.070	10" 318	\$8.77 N
DM 33	28	7	540	.250	10" 456	\$5.50 LN
DM 42	14	46	515	.110	8" 456	\$6.50 LN
			1030	.050		2.8

PE 55	12	25	500	.100	SCR 215	\$5.25 LN
PE 86	28	1.25	250	.060	10" 36	\$3.95 N
PE 101 C	13-26	12-1/2	400	.135	SCR 515	\$5.25 N
		6.3	800	.020		
			9 AC	1.12		

BD AR 93	28	3.25	375	.150		\$1.95 N
23350	27	1.75	385	.075	APN-1	\$3.50 N
35X45B	28	1.2	250	.060		\$3.50 N
ZA .0515	12-21	4/2	500	.050		\$3.95 N
B-19 Pack	12	9.4	275	.110	Mark II	\$0.95 N
			500	.050		

*N—New. LN—Like New.

INVERTERS

PE 206-A: Input: 28 Vdc @ 38 amp. Output: 80 volts @ 500 volt-amps, 800 cycles. Leland, New, complete with enclosed relay, filter, instruction book \$12.50
 PE 218: Input: 25-28 Vdc @ 92 amps. Output: 115 volts @ 1500 volt-amps, 380-500 cycles. New, Herm. Sealed. \$49.95

30' U.S. ARMY SIGNAL CORPS RADIO MASTS

Complete set for the erection of a full flat top antenna. Of rugged bimetal construction telescoping into 3 ten-foot sections for ease of storage and transportation. A perfect set-up for getting out. Supplied complete: 2 complete masts, hardware, shipping crate, Shipping wt. approx. 300 lbs. Sig Corps #2A289-223-A. New \$39.50 per set

AUTOMATIC CODE EQUIPMENT

Tape Pullers (McElroy), TP 890, 110-120 v. AC DC \$12.50 ea.
 TAPE BRIDGES (McElroy) TG 815, complete \$3.50 ea.
 TAPE LOGS: For TU-8 and TG-9 \$1.00
 CODE TAPE, blank paper, 8" rolls, 11/16" wide Per roll \$5.00



BAND PASS FILTER

#70473. Sha-PD band pass peaked at 700 cps. Bandwidth: 650 cycles at 20 db. Down from peak. High-to-high impedance. Can be plugged into phone output of receiver for band results. Cuts out QRM. New with circuit diagram \$2.25

GREAT TUBE VALUES

01-A	\$.45	6V6GT	.79	804	9.95
1B24	4.85	7C4	1.00	815	2.50
1M5	.55	7E5	1.00	836	1.15
1N5	.69	7E6	.72	837	1.95
1T4	.69	10Y	.61	843	.59
2C21	.69	12AB	14.35	860	15.00
2C22	.69	12CP7	.65	874	1.95
2J21-A	25.00	12KBY	.49	876	4.95
2J22	25.00	12SP7	.72	878	78.50
2J26	25.00	12SR7	1.40	1005	.35
2J27	25.00	15R	.75	1813	.95
2J31	25.00	28D7	.70	1824	.83
2J32	25.00	30 (Spec)	.59	1629	.35
2J38	25.00	45 (Spec)	.49	1961	5.00
2J39	25.00	39 44	.70	8012	3.95
2J58	25.00	35 51	3.85	9002	.65
3J31	55.00	227A	6.80	9006	.47
2X2 879	60	225	20.00	CEQ 72	1.95
3A4	.65	268-A	19.50	EF 50	.79
3BP1	2.25	253-A	.85	FC 127	20.00
3C24	.60	417A	90.00	FC 258A	185.00
3C30	.70	530	45.00	FC 271	60.00
3D8	.79	531	3.91	GL 562	75.00
3CP1 51	3.50	532	4.00	GL 623	75.00
3D21-A	1.50	559	90.00	GL 697	75.00
3DP1	2.25	562	.70	ML 100	60.00
3EP1	2.95	615	7.00	QC 258A	65.00
3FP7	1.20	703-A	.75	QC 60	65.00
3GP1	3.50	704-A	2.85	QC 61	65.00
3QS	.79	705-A	120.00	RC 62	65.00
5BP1	1.20	707-B	15.00	RCA 932A	.65
5BP4	4.95	714AY	12.00	VR 91	1.00
5CP1	3.75	715-B	50.00	VR 130	1.25
5FP7	3.50	720BY	3.60	VR 137	1.25
5JP2	8.00	720CY	12.51	VU 120	1.00
5J30	39.50	721-A	1.75	VU 134	1.00
6AC7	1.00	723-A	2.50	WL532	4.75
6G	2.00	724B	15.00	WT 260	5.00
6J6	1.00	724-D	2.25	With Caution	
6M7	.55	725-A	25.00		
6L6GA	1.00	726-A	1.10		
6SC7	.70	800	1.10		
6SL7	1.00	801-A			

131-C
 Liberty St.
 New York 7, N.Y.

All merchandise guaranteed. Mail orders promptly filled. All prices, F.O.B. New York City. Send Money Order or Check. Shipping charges sent C.O.D.

COMMUNICATIONS EQUIPMENT CO.

MANUFACTURERS QUANTITIES AVAILABLE

PHONE DIGBY
 9-4124



ELECTRIC PORTABLE PHONOGRAPH
 Leatherette Covered 2 Watt Amplifier. Plays 12 inch records with cover closed. 5 inch Alnico 5 Speaker. Bin drive constant speed. Self starting motor. High fidelity pickup. Size 17 1/2" x 7 1/2". Last Price \$29.95.
 NET PRICE \$15.95
 LOTS OF THREE \$14.95

SPECIAL PURPOSE RADIO TUBES

1B22	\$ 4.95	28D7	1.95
3B24	1.95	371B	2.95
3BP1	2.95	701A	4.95
3HP7	3.95	705A	2.95
5AP1	3.95	576	.80
5CP7	13.95	1629	.49
5JP4	4.95	2051	.91
7BP7	3.95	VT-52	.93
12GP7	12.95	211	.93

SPEAKERS

- 4" P.M. Speaker \$1.25
- 5" P.M. Speaker 1.25
- 6" P.M. Speaker 1.98

SPECIAL! VOLUME CONTROL

1/2 meg with switch 3 for 99c

TERMS: 25% with Order—Balance C.O.D.—F.O.B. Chicago
 Prices Subject to Change
 Without Notice
 Notice: Minimum Order \$2.00

TUBES! NATIONALLY ADVERTISED BRANDS TUBES!

RCA — Kenrad — Sylvania — Teng-Sol — National Union — Raytheon — Philco — Hytron
 All new tubes, 100% guaranteed, individually boxed.

TYPE	PRICE	TYPE	PRICE	TYPE	PRICE	TYPE	PRICE	TYPE	PRICE
0A4G	\$.96	1T5GT	.96	6F5GT	.60	6X5GT	.54	12K8	.65
01A	.60	1V	.80	6F6	.72	6Y6G	.85	12SA7GT	.65
0Y4	1.72	2A3	1.15	6F6G	.60	6Z7G	1.40	12SC7	.80
0Z4	.80	2A4G	1.15	6F7	1.15	6ZY5G	.80	12SF5	.65
1A3	.80	2A5	.80	6F8G	1.15	7A4	.65	12SF7	.72
1A4P	1.40	2A6	.96	6G6G	.96	7A5	.65	12SG7	.72
1A5GT	.65	2B7	.96	6H6GT	.60	7A6	.65	12SH7	.80
1A6	1.15	2X2	1.15	6J5GT	.54	7A7	.65	12SJ7	.60
1A7GT	.72	3A4	.72	6J6	.96	7A8	.65	12SK7GT	.60
1B4P	1.40	3B7/1291	.96	6J7	.72	7B4	.65	12SL7GT	.85
1B5 25S	1.15	3D6/1299	.96	6K6GT	.54	7B5	.65	12SN7GT	.80
1C5GT	.80	3Q4	.80	6K7G	.60	7B6	.65	12SQ7GT	.60
1C6	1.15	3Q5GT	.85	6K8	.85	7B7	.65	12SR7	.80
1C7	1.15	3S4	.72	6L5G	.96	7B8	.65	12S8T	.80
1D5GP	1.40	4R4GY	1.15	6L6GA	1.15	7C5	.65	12T5(6Z5)	.96
1D7G	1.15	4T4	1.40	6L7	1.15	7C6	.65	150A5	.80
1D8GP	1.40	4U4G	.54	6N7	.85	7C7	.65	150B5	.72
1E5GP	1.40	5V4G	.85	6P5GT	.80	7E8	.65	14A7	.80
1E7GT	1.40	5X4G	.85	6Q7	.72	7E9	.65	14B6	.80
1F4	.96	5Y3GT	.45	6R7	.96	7F7	.80	14C7	.80
1F5G	.96	5Y4G	.54	6RS7	.65	7F8	.96	14H7	.80
1F6	1.40	5Z3	.85	6S7	.96	7G7	.96	14J7	.96
1F8	.96	5Z3	.85	6SA7GT	.60	7H7	.72	14K7	.80
1G5G	.96	6A3	.96	6S8GT	.85	7J7	.96	14L7	.80
1G6GT	.96	6A4 LA	1.15	6SB7Y	.85	7K7	.96	14W7	.96
1H4G	.80	6A6	.96	6RC7	.72	7L7	.80	19	1.15
1H5GT	.60	6A7	.72	6RD7GT	1.15	7M7	.80	24A	.80
1H6G	1.15	6ARGT	.72	6SF5	.72	7Q7	.65	21A7	1.15
1H6	.96	6AB7	1.15	6SF7	.72	7R7	.96	25L6GT	.60
1L4	.72	6AC7	.96	6SG7	.72	7W7	.96	25Z3	.54
1LA4	.96	6AD7G	1.15	6SH7	.80	7X7(XFM)	.96	21Z6GT	.54
1LA6	.96	6AF6G	.96	6SJ7	.60	7Y4	.65	26	.85
1LB4	.96	6AG5	.96	6SK7GT	.60	7Z4	.65	26A7	1.15
1LC5	.96	6AG7	1.15	6SL7GT	.85	12A5	.85	27	.54
1LD5	.96	6AK5	.96	6SN7GT	.80	12A6	1.15	30	.72
1LG5	.96	6AL5	.72	6SQ7	.60	12A6	.96	31	.96
1LE3	.96	6AL7	.96	6SR7	.65	12A7	1.15	32	1.15
1LH4	.96	6AQ7	.80	6SS7	.80	12A8	.65	32L7GT	1.15
1LN5	.96	6AT6	.54	6ST7	.96	12AH7GT	1.15	33	1.15
1NSGT	.72	6B4G	.96	6SV7	1.15	12AT6	.80	34	1.15
1P8	.72	6B7	1.15	6T7G	1.15	12BA6	.65	35	.72
1P5GT	.80	6B8G	1.15	6U5	.72	12BE6	.65	35A	

Here's a SENSATIONAL BUY! COMBINATION INTERCOM & RADIO

Customers Say—

"Intercom alone is worth your low price. You get free a 6 tube radio in this deal plus real utility!"

A REAL MONEY MAKER FOR YOU



Intercom Sub-Station Master Intercom Station, Including 6-Tube Radio

Combines a top-quality 6 tube superhet receiver, plus office or home intercom system in handsome walnut-veneered cabinets. Hi-Amplification 3 tube intercom permits instant communication between radio-master and up to 4 remote sub-stations. Any remote station can call the master while radio is playing; call can be returned to any remote station. Operates on 110 volts AC or DC.

It's handsome—It's easy to install—It's easy to use!

Price Includes Radio Master, 1 Remote, 50' wire

Original retail price was \$84.50 with 4 remotes. Buy from RSE and SAVE OVER 50%.

Brand new—only 400 available.

\$29⁹⁵

Extra Remotes —\$3.95

MIDGET I.F. TRANSFORMERS

Back again—by popular demand!



RSE scores again with a new and better I. F. I. 400-500 KC range—1 1/4" square x 3" high—ceramic based mica trimmers—high gain iron cores—pep up old receivers, ideal for new construction—and now available in either input or output types—for peak performance! Individually boxed in the colorful RSE carton. List price \$2.10. LRI—input; LR2—output;

Specify Type.

Each	Matched Pair	Dozen	Egg Crate of 100
36c	69c	\$3.95	\$29.00



VOLUME CONTROLS

Our own private brand—made by a nationally known manufacturer. The same kind that net for \$1.09. Noise-free carbon construction, standard shaft and bushing. Individually boxed in our colorful carton carrying the RSE equality seal of approval. Complete with switch, full range of sizes.

10 M ohms	100 M ohms	each	59c
15 M ohms	250 M ohms		
25 M ohms	500 M ohms		
50 M ohms	1 Meg ohms	per 10	\$5.50
7 Meg ohms		ass'd.	
500 M Knurled Shaft			
500 M ohms less switch, 39c each, 100 for \$35.00			

TUBES

"The All-American Five"

Here they are—the fastest movers ever made—at RSE's long discount. Brand new, tested top-grades with regular RMA guarantee. Individually boxed in eye-appealing cartons. Know your supplier—his reputation. Shoot us on order today—watch your profits zoom tomorrow!



12SA7GT . . .65 12SK7GT . .65 12SQ7GT . .59
35Z5GT . . .49 50L6GT . .65

"All-American Kit", one each of above . . \$2.98



Demand This Seal of Quality

ORDER INSTRUCTIONS

Minimum order—\$2.00. 25% deposit with order required for all C.O.D. shipments. Be sure to include sufficient postage—excess will be refunded. Orders received without postage will be shipped express collect. All prices F.O.B. Detroit.

RADIO SUPPLY & ENGINEERING CO., Inc.
85 SELDEN AVE. DETROIT 1, MICH.

CONTROL OF POWER

Patent No. 2,444,153

Samuel C. Coroniti

(assigned to General Aniline & Film Corp.)

This discloses a means of controlling large amounts of power by a small change of frequency. The power is developed in the plate load of a thyratron. This tube is a.c. operated. Its grid is connected through R (a current limiter) to a point between a resistance (plate resistance of the 6SA7) and a condenser C. The phase of the grid voltage depends upon the relative values of this resistance and the condenser.

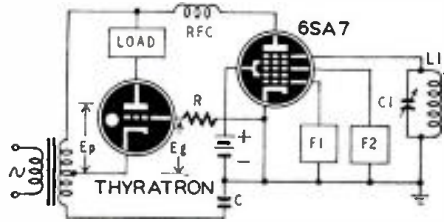

The current which flows in the plate circuit of a thyratron is greatest when the plate voltage Ep is in phase with the grid voltage Eg. It is zero when these voltages are out of phase.

Two signals are impressed upon the grids of the 6SA7. One of them "F1" is crystal controlled. The other "F2" is variable and is the controlling factor. It may be generated locally or may be received by radio if remote control is desired. The parallel circuit LI-C1 is tuned near the beam frequency F1—F2. It is designed for high Q for sharp tuning. As F2 is varied over a narrow range the impedance of the tuned circuit varies over a wide range. Therefore the voltage across it also changes and affects the plate resistance of the tube.

When the 6SA7 plate resistance is very low the grid and plate voltages on the thyratron are almost out of phase. When the resistance is very high, these voltages are almost in phase. Therefore the power in the load depends upon the frequency of F2.

MAGNETIC SORTER

Patent No. 2,444,751

Kenneth L. Scott, Western Springs, Ill.

(assigned to Western Electric Co., Inc.)

This apparatus sorts material according to magnetic properties. The long nonmagnetic tube divides into two branches at its lower end. Here a pivoted gate is arranged to open one of the passages and to close the other when a magnetized object is dropped into the tube.

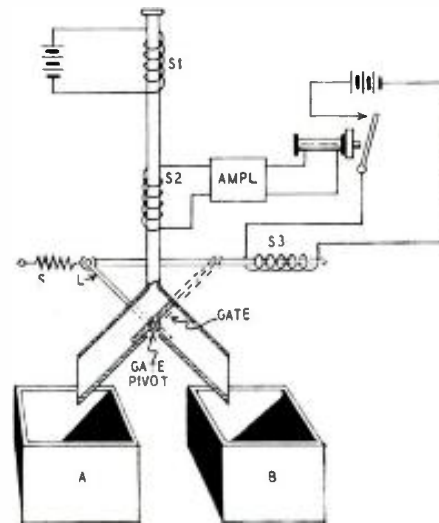

The pivoted gate is fixed to a lever L at right angles to it. Normally L is forced to the left by a spring S. This position is shown by full lines in the drawing. When L is forced towards the solenoid S3, the lever and gate take the position shown by dotted lines. Note that in the

first case only the passage leading to A, in the second case only that to B, is open.

The vertical tube has two windings. The upper one (S1) is energized from a d.c. source. The other (S2) is connected across an amplifier input circuit. When an object is dropped into the tube it becomes magnetized on passing through S1. If it retains magnetism until it goes through S2 a voltage will be induced in that winding. The voltage change is amplified and energizes the output relay. S3 is magnetized for a short interval. As described previously this opens the passage to B into which the object drops. If the object does not make a good permanent magnet it drops into A.

FIELD MEASURING TUBE

Patent No. 2,437,374

Robert E. Burroughs, Washington, D. C.

(assigned to Eastman Kodak Co.)

Originally designed for electronic gun-sights, this tube has many other practical applications. It is about the size of a walnut and is very sensitive. The tube contains one cathode, two anodes, and a suppressor. In addition there are two "compressors" which focus the electrons into two distinct beams from cathode to anodes.

The plate currents are adjusted to be equal without a magnetic field. Then, if the tube is placed in a field the beams are deflected. Usually one beam is deflected more than the other, and there is an unbalance across the plate loads. This voltage unbalance is indicated on a meter after amplification.

An important use of the tube is to indicate change of position. A tiny magnet is clamped to one object, and the tube is fixed to another. When their distance varies, the change in the field around the tube shows up on the meter. The tube can even be used to detect weak magnetization of a watch. The motion of the magnetized spring creates the changing field.

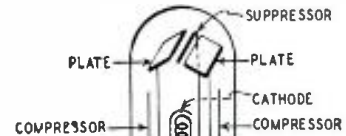

AUTOMATIC BEAM CONTROL

Patent No. 2,448,299

Arthur Dorne, Mineola, N. Y.

(assigned to United States of America as represented by the Sec'y of the Army)

Automatic control of the maximum beam intensity on the screen of a cathode-ray tube is provided by this patented circuit. This intensity increases as the sweep is reduced, and vice-versa. If the intensity is maintained too high, the screen is damaged.

The sweep is connected to the deflecting plates (or coils) of a cathode-ray tube and also through a network to tube D1. The sweep voltage must go positive during some portion of its cycle. During the positive period, D1 conducts and charges condenser C, the A side being negative.

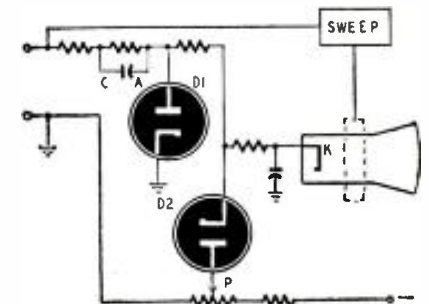

IT'S CHRISTMAS ALL YEAR 'ROUND AT SENCO!

Yes, from the top of our tubes to the bottom of our cartridges we're ALWAYS in holiday spirits. Our presents are our prices—our gifts are our values! No need to look elsewhere **WHATEVER** the month.

SPEAKER SPECIAL!



No doubt about it—here's one of the finest speakers made. You'll be in for a pleasant surprise when you see the name. So don't delay—order today!

12" P.M. ALNICO V, ONLY **\$3.95**
LIMIT 4 TO A CUSTOMER

MILWAUKEE AUTOMATIC RECORD CHANGER



ONLY **\$11.95**

Compl'te with L-82 Astatic crystal cartridge, Mounting Springs and Full Instructions. A terrific buy!

Famous VOLUME CONTROLS



Nationally advertised brand! An exceptional buy! All brand new. Stock up now!

With Switch
10,000 ohms V.C., 2" shaft
25,000 ohms V.C., 3" shaft
50,000 ohms V.C., 3" shaft
100,000 ohms V.C., 2" shaft
With Switch and Tapped
250,000 ohms V.C., 3" shaft
500,000 ohms V.C., 3" shaft
1 meg ohms V.C., 3" shaft
2 meg ohms V.C., 3" shaft

only 44c ea.

THOUSANDS OF TUBES

Type	Each	Lots of Each
OZ4	69	59
1A3	45	39
1A7	55	49
1A7GT	55	49
1L4	49	45
1LC6	69	59
1LH4	69	59
1LN5	69	59
1R4	69	59
1R5	55	49
1S5	59	55
1T4	69	55
1U4	49	39
1U5	39	39
1V	45	39
2A5	54	43
2A6	45	35
2A7	39	29

R.M.A. GUARANTEE

Type	Each	Lots of Each
2X2	879	35
3A4	49	39
3B7	1291	59
3Q4	59	49
3Q5	55	49
3S4	55	45
3V4	79	69
5U4G	50	40
5W4GT	39	34
5X4G	39	35
5Y3G	42	37
5Y3GT/G	40	33
5Z3	59	49
5Z4	59	49
6A7	49	45
6A8GT	49	39
6AC5	69	59
6AC7	1852	65
6AG5	79	69
6AH6	49	39
6AK5	74	69
6AL5	49	38
6AL7	69	59
6AN5	65	55
6AQ6	59	55
6AQ7	65	59

ALL BRAND NEW

Type	Each	Lots of Each
6AT6	49	39
6AU6	49	39
6AV6	49	39
6BA6	49	39
6BG6G	89	79
6BE6	49	38
6BH6	79	69
6BJ6	59	49
6C4	29	25

Type	Each	Lots of Each
6C5GT	40	35
6D6	49	45
6F6GT	45	39
6F7 VT70	39	29
6H6GT/G	45	39
6J3GT	45	39
6J7GT	42	38
6K6GT/G	45	39
6K7	55	45
6K7G	50	41
6K7GT/G	49	39
6L5G	69	59
6L7	84	78
6N4	39	38
6R7GT	49	49
6SA7GT/G	44	37
6SB7	55	45
6SH7GT	40	32
6SJ7GT	44	37
6SK7GT/G	49	39
6SL7GT	49	47
6SN7GT	49	47
6SQ7GT/G	44	37
6SS7	59	49
6SV7	55	49
6T8	89	79
6U5 6G5	69	59
6U7G	25	25
6V5G	59	49
6V6GT/G	45	39
6X5GT/G	49	39
7A4	53	43
7A7	59	49
7B6	49	44
7B8	69	59
7C5	55	49
7F7	49	44
7J7	54	49
7N7	49	44
7Q7	69	59
7X7 (XXFM)	44	35
7Y4	44	35

INDIVIDUALLY CARTONED

Type	Each	Lots of Each
12A6	29	25
12A8GT	35	28
12A7E	50	45
12A7T	69	59
12A06	65	55
12AV6	49	39
12BA6	50	45
12BE6	50	45
12F5GT	35	27
12H6	39	34
12J5GT	25	19
12J7GT	45	39

Type	Each	Lots of Each
12K8Y	35	25
12SA7GT G	49	32
12SF7	35	32
12SC7, 1634	49	39
12SG7	55	45
12SJ7GT	55	49
12SK7GT G	45	35
12SL7	49	43
12SN7	49	43
12SQ7GT G	40	32
12SR7	35	32
14A7	65	55
14B6	59	49
19T8	89	79

IMMEDIATE DELIVERY

Type	Each	Lots of Each
24A	49	39
25Z5	49	45
25Z6GT/G	49	39
26	26	45
27	49	44
32L7GT	52	48
35/51	42	32
35L6GT/G	45	39
35W4	43	40
35Y4	43	40
35Z5GT/G	43	39
35Z6G	43	39
39/44	25	19
42	45	41
50A5	65	60
50B5	42	32
50L6GT	50	45
52	55	45
57	45	39
58	45	39
70	49	45
77	35	27
78	49	39
80	40	38
83V	79	69
84/6Z4	49	39
85	49	45
89	49	45
99V	35	25
99X	35	25
117Z6GT/G	89	76
1231	39	29
1644	29	19

OIL FILLED CONDENSERS

Standard Brand, Upright Type, Stand-Off Insulators.

4 Mfd. 600 VDC	\$.45
6 Mfd. 600 VDC	.69
7 Mfd. 600 VDC	.74
8 Mfd. 600 VDC	.79
10 Mfd. 600 VDC	.89
8 Mfd. 1000 VDC	1.90

DIVIDEND OF THE MONTH!

2051 THYRATRON GAS-TETRODE TUBE

only 49c each While They Last!

FREE CIRCULAR

Our brand new 1949 Circular will be off the press very soon. Send us your name and address now to be sure you are one of the first to receive it!

MINIMUM ORDER \$1.00 WHEN ORDERING—Send 25% deposit for all C.O.D. Shipments. Include sufficient postage—**excess will be refunded.** Orders without postage will be shipped express collect. All prices F.O.B. New York City.



Dept. C, 73 West Broadway
New York 7, N. Y. BEEKMAN 3-6498

During the remainder of the cycle, the negative voltage adds to that on the condenser and is applied to cathode K. This increases the beam intensity.

The greater the sweep, the more intense the screen image. A limit is provided by D2 which begins to conduct at some critical value. The P adjustment sets the maximum intensity.

CRYSTAL OSCILLATOR

Patent No. 2,444,349

Charles W. Harrison, Flushing, N. Y.

(assigned to Bell Telephone Labs., Inc.)

This oscillator, which works well even with sluggish crystals, is suitable for driving a trans-

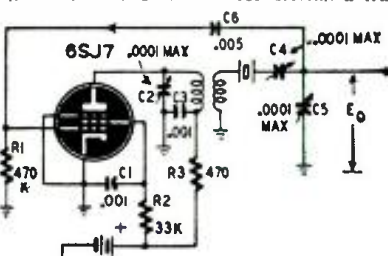

Crystal Oscillator Parts List

- R1—470,000 ohms
- R2—33,000 ohms
- R3—470 ohms
- C1, C2—.001 uf
- C3, C4, C5—100 puf.
- variable

mitter or as a crystal test set. Frequency and amplitude stability are excellent. In addition, the frequency is variable over a limited range. Feedback is adjustable to accommodate different types of crystals.

The tube may be a 6SJ7. Circuit constants shown are suitable for operation at about 5 mc. The feedback depends upon the ratio of C5 to C4. These condensers also tune the transformer secondary to the crystal frequency. The secondary should have relatively few turns compared to the primary.

The oscillator frequency is tuned over a small range by adjusting the two variable condensers. With more active crystals the feedback may be reduced.

WATCH TIMER

Patent No. 2,445,916

Jean L'Esplattener, La Chaux de Fonds, Switzerland

With this apparatus any watch may be compared quickly with a standard watch. It indicates whether the tested watch runs too slow or too fast, and how much of either.

The watch being tested is shown as W near a microphone M. The audio output is amplified and connected to a relay RY1. This relay operates at every tick of the watch. The standard watch S has built-in contacts which are closed mechanically at every beat. This watch is adjusted to lose one beat every 30 seconds.

At some instant the beats from W and S will coincide. Resistor R is then shorted out to provide sufficient voltage from the potentiometer to actuate relay RY2. Also relay RY1 operates and removes the shunt across RY2. Operation of RY2 starts the stop watch SW.

Some time later beats from the two watches again coincide and again RY2 operates. The stop

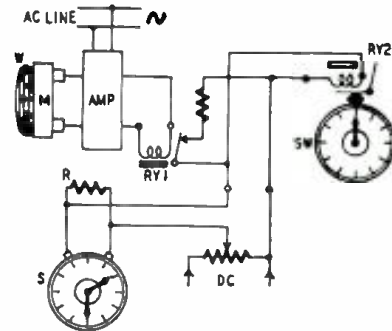

watch then stops and indicates the speed of the test watch. If W runs correctly, this happens exactly 30 seconds later. If it is too slow, it occurs later, and if too fast, the beats coincide earlier. The stop watch indicator travels around once every 30 seconds, and its face is calibrated in seconds per day to show the speed of the watch, W.

ELECTRONIC VOLTAGE REGULATOR

Patent No. 2,445,171

Wm. S. Graff-Baker, Rugby, England (assigned to General Electric Co.)

Offering greater control range than conventional regulators, this circuit uses a screen grid as V1 instead of the usual triode, and there are two additional resistors R1 and R3. Also, R1 and R2 are ganged so that R1 is automatically increased as R3 is adjusted toward the lower terminal. In the usual circuit, control becomes sluggish as V1 nears saturation. The new circuit eliminates this difficulty.

R2 is set near its upper terminal if greater voltage output is desired. This increases V2 plate current and puts a more negative potential on the control grid of V1. V1 does not operate near saturation and its grid has sufficient control. The value of R1 is small, and V1 therefore acts like a triode.

For low voltage across the load, R2 is set near the lower terminal. The control grid of V1 becomes more positive and the tube approaches saturation. Therefore, the grid has much less control than before. With this setting, however, R1 is much greater and V1 acts like a screen-grid tube. The amplification increases, and the grid still controls the regulation.

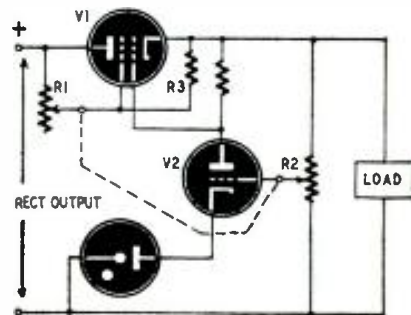

AT LAST!! A LOW COST POWER UNIT FOR SERVICE WORK

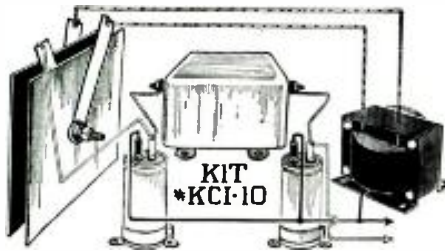

**"A" ELIMINATOR KIT
*KC 1-10**

only \$19⁵⁰

Including pictorial and schematic diagrams

For the first time, we are offering a well-engineered six volt direct current power unit for auto-radio and similar service work in *kit form*!!

This unit was formerly in the high priced range. Now, we have placed all the essential components necessary for construction in kit form, and are offering them to you at this low, low price.

These kits fulfill the long-standing need of every serviceman and technician. They are designed to operate from a 115 V.A.C. 50/60 cycle source, and deliver 6 V.D.C. well-filtered from three to eight amperes, with a peak rating of ten amperes. The A.C. ripple percentage is held to remarkably low values.

This unit charges a standard auto battery in one day!!

- Do away with bulky batteries!
- Do away with corroding fumes!
- Simplify your service operation!

Order this fine kit for your bench today !!

No C.O.D.'s. Full remittance with order. Shipping wt., 12 lbs.

OPAD-GREEN COMPANY

71 Warren St. Phone: BEekman 3-7385 New York 7, N. Y.

Mr. Radio Serviceman

ADDITIONAL \$\$\$\$ FOR YOU EVERY WEEK REPAIR ELECTRICAL APPLIANCES



WITH THE AID OF THE NEW MODEL 40 UTILITY TESTER

A NEW KIND OF INSTRUMENT FOR TESTING ALL ELECTRICAL CIRCUITS AND APPLIANCES SUCH AS—

- *RANGES *WASHERS *VACUUM CLEANERS
- *SHAVERS *FANS *AIR CONDITIONERS
- *HEATERS *MOTORS *REFRIGERATORS
- *IRONERS *TOASTERS *SUN LAMPS
- *WASHING MACHINES *ALL TYPE MOTORS FROM FRACTIONAL H.P. TO 2 H.P.

THE MODEL 40 UTILITY TESTER

Will test Thermostats under ACTUAL WORKING CONDITIONS; Will measure the ACTUAL CURRENT CONSUMPTION of any appliance either A.C. or D. C. WHILE THE UNIT IS IN OPERATION—reading will be direct in amperes—the appliance or utility may be plugged directly into front panel receptacle—a special pair of insulated clip-end leads is provided for motors; Incorporates an ultra-sensitive direct-reading resistance range which will accurately measure all appliance and utility resistances down to a fraction of an ohm; Will test bulbs, fuses, condensers, field coils, etc.; Is ideal trouble shooter as it will instantly locate opens, shorts and grounds; Will locate cause of failure in three way heat control switches; will indicate when one side of an appliance or motor connected to line under test is "grounded"; Will indicate excessive leakage between a motor and a line; Will indicate when a three phase motor is running erratically due to a "blown" fuse; Will indicate whether the voltage is 110 Volts or 220 Volts, if the current is A.C. or D.C. and if the frequency is 25 cycles or 60 cycles.

The Model 40 Utility Tester comes housed in a rugged crackle finished steel cabinet with portable cover, complete with all test leads and operating instructions—only **\$15⁷⁵**

GENERAL ELECTRONIC DISTRIBUTING CO. 98 PARK PLACE, Dept. R.E. 12 NEW YORK 7, N. Y.

The great length of the present station list precludes printing a complete account of records made by FM listeners. Greatest distance reported was by Leon H. Hinman of Ithaca, N. Y. He received KTRH-FM of Houston, Texas, on the evening of June 2. Another interesting report is from Earl Cunningham, of Webster, Mass., who sends us a list of 32 stations from Portsmouth, N. H., to Philadelphia, Pa.

Mr. C. R. Bills of South Bend, Indiana, has a list of several stations ranging from 70 to 975 miles (this last one KXYZ-FM, Houston, Texas).

CITY	CALL	FREQUENCY
ALABAMA		
Anniston	WHMA-FM	100.5
Birmingham	WAFM	99.5
Birmingham	WJLD-FM	104.7
Birmingham	WGSN-FM	93.7
Gadsden	WJBY-FM	103.7
Huntsville	WHBS-FM	95.1
Lanett	WRLD-FM	102.9
Mobile	WKRG-FM	99.9
Mobile	WMOB-FM	97.5
Montgomery	WCOV-FM	94.5
Montgomery	WMGY-FM	107.5
Montgomery	WSFA-FM	103.3
Sylacauga	WSYO	101.9

ARKANSAS		
Blytheville	KLCN-FM	96.1
Fort Smith	KFPW-FM	94.9
Fort Smith	KFSA-FM	107.7
Fort Smith	KRKN-FM	102.1
Jonesboro	KBTM-FM	101.9
Siloam Springs	KUOA-FM	105.7

CALIFORNIA		
Alameda	KONG	104.9
Bakersfield	KERN-FM	94.1
Chico	KVCI	101.1
Eureka	KRED	96.3
Fresno	KARM-FM	101.9
Fresno	KRFM	93.7
Hollywood	KNX-FM	93.1
Los Angeles	KCLI	105.1
Los Angeles	KECA-FM	95.5
Los Angeles	KFAC-FM	104.3
Los Angeles	KFI-FM	105.9
Los Angeles	KFMV	94.7
Los Angeles	KHJ-FM	101.1
Los Angeles	KKLA	97.1
Los Angeles	KMG	98.7
Los Angeles	KMFC-FM	100.3
Los Angeles	KRKO-FM	96.3
Los Angeles	KUSC	91.5
Marysville	KMYC-FM	97.5
Merced	KVME	97.5
Modesto	KBEE	103.3
Oakland	KLX-FM	101.3
Ontario	KOCS-FM	93.5
Pasadena	KAGH-FM	98.3
Redding	KVRE	103.9
Richmond	KRCC	104.5
Riverside	KPOR	97.5
Sacramento	KCRA-FM	96.1
Sacramento	KFBK-FM	96.9
Sacramento	KXOA-FM	107.9
San Bernardino	KBMT	99.9
San Bernardino	KFXM-FM	95.1
San Bruno	KSBR	100.5
San Diego	KFMB-FM	101.5
San Diego	KFSD-FM	94.1
San Diego	KSDO	96.5
San Diego	KWFM	104.7
San Francisco	KALW	91.7
San Francisco	KDFC	102.1
San Francisco	KGO-FM	106.1
San Francisco	KJBS-FM	98.9
San Francisco	KNBC-FM	99.7
San Francisco	KQW-FM	103.7
San Francisco	KRON-FM	96.5
San Francisco	KSFH	94.9
San Francisco	KWBR-FM	97.3
San Jose	KRPO	92.3
San Jose	KSJO-FM	95.3
San Luis Obispo	KVEC-FM	99.9
Santa Maria	KRJM	103.1
Santa Monica	KCRW	89.9
Stockton	KCVN	91.3
Stockton	KGDM-FM	92.9

COLORADO		
Denver	KFEL-FM	97.3
Denver	KLZ-FM	94.1
Denver	KOA-FM	95.7

CONNECTICUT		
Danbury	WLAD-FM	98.3
Hartford	WDRG-FM	93.7
Hartford	WHTT-FM	106.1
Hartford	WTIC-FM	96.5
Meriden	WMMW-FM	95.7
New Britain	WKNB-FM	103.7
New Haven	WBIB	100.7
New Haven	WAVZ-FM	95.1
New Haven	WEMI	107.1

CITY	CALL	FREQUENCY
New Haven	WNHC-FM	99.1
New London	WNLC-FM	99.5
Stamford	WSTC-FM	96.7
DELAWARE		
Wilmington	WAMS-FM	96.1
DISTRICT OF COLUMBIA		
Washington	WASH	97.1
Washington	WINF-FM	96.3
Washington	WMAL-FM	107.3
Washington	WOL-FM	98.7
Washington	WQOW-FM	103.5
Washington	WRC-FM	93.9
Washington	WWDC-FM	101.1
FLORIDA		
Daytona Beach	WNDB-FM	94.5
Fort Lauderdale	WGOR	106.5
Gainesville	WRUF-FM	104.1
Jacksonville	WJHP-FM	96.9
Jacksonville	WMBR-FM	96.1
Miami	WGBS-FM	96.3
Miami	WIOD-FM	97.3
Miami	WQAM-FM	94.9
Miami	WTHS	91.7
Miami	WWPB-FM	101.5
Miami Beach	WKAT-FM	93.1
Orlando	WHOO-FM	96.5
Palm Beach	WWPG-FM	97.9
Pensacola	WCOA-FM	98.9
St. Petersburg	WTSP-FM	102.5
Tallahassee	WTAL-FM	103.9
Tampa	WDAE-FM	105.7
Tampa	WFLA-FM	93.3
West Palm Beach	WJNO-FM	98.7
GEORGIA		
Atlanta	WAGA-FM	103.3
Atlanta	WATL-FM	97.5
Atlanta	WBGE-FM	95.5
Atlanta	WCON-FM	98.5
Atlanta	WGST-FM	94.1
Atlanta	WSB-FM	104.5
Cedartown	WGAA-FM	96.1
Columbus	WDAK-FM	107.9
Columbus	WGBA-FM	95.1
Columbus	WRBL-FM	93.3
La Grange	WLAG-FM	104.1
Macon	WBML-FM	100.7
Macon	WMAZ-FM	99.1
Newnan	WCOH-FM	92.3
Rome	WRGA-FM	106.5
Savannah	WSAV-FM	100.3
Savannah	WTOC-FM	97.3
Toccoa	WLET-FM	102.9
Valdosta	WGOV-FM	92.5
IDAHO		
Boise	KIDO-FM	106.1
Nampa	KFXD-FM	101.9
Pocatello	KSEI-FM	96.5
Twin Falls	KTFI-FM	99.7
ILLINOIS		
Alton	WOKZ-FM	99.9
Aurora	WBNU	103.9
Bloomington	WJBC-FM	101.5
Canton	WBYS-FM	100.9
Carbondale	WCIL-FM	100.7
Chicago	WBBM-FM	97.1
Chicago	WBEZ	91.5
Chicago	WBIK	96.3
Chicago	WEFM	99.5
Chicago	WEHS	97.9
Chicago	WENR-FM	94.7
Chicago	WFMF	100.3
Chicago	WGNB	98.7
Chicago	WMAQ-FM	101.1
Chicago	WMBI-FM	95.5
Chicago	WXRT	101.9
Decatur	WSOY-FM	102.1
Elmwood Park	WLEY	107.1
Evanston	WEAW	96.7
Freeport	WFJS	102.5
Harrisburg	WEBQ-FM	99.9
Herrin	WJPF-FM	98.5
Jacksonville	WLDS-FM	100.5
Kankakee	WKIL	100.7
La Grange	WRGK	103.1
Mount Vernon	WMIX-FM	94.1
Oak Park	WOAK	98.3
Peoria	WMBD-FM	92.5
Quincy	WQDI	105.1
Quincy	WTAD-FM	99.5
Rock Island	WHBF-FM	98.9
Springfield	WCVS-FM	102.9
Springfield	WTAX-FM	103.7
Urbana	WIUC	91.7
Waukegan	WKRS	106.7
Woodstock	WILA	92.1
INDIANA		
Bloomington	WFUI	90.9
Columbus	WCSI	93.7
Connersville	WCNB-FM	100.3
Crawfordsville	WFMU	102.9
Elkhart	WTRC-FM	100.7
Evansville	WIKY-FM	104.1
Evansville	WMLL	94.5
Ft. Wayne	WTFW-FM	103.7
Ft. Wayne	WKJG-FM	106.1
Ft. Wayne	WOWO-FM	96.1
Hammond	WJIZ	92.3
Indianapolis	WMHC	97.1
Indianapolis	WXWL-FM	94.7
Kokomo	WKMO-FM	99.9
Lafayette	WFAM	95.1

"It's Fun to STRIP"

—WIRE—
Says Speedy

with the



Speedex

WIRE STRIPPERS

- Strip 300 ohm Twin F.M. and Television lines
- Strip all types wires sizes 8 to 30

G-C announces a new television and F.M. tool for 300 ohm twin line. It will easily strip both wires at the same time. Just place the wire between the jaws and squeeze—insulation will come off instantly without moving the wire. A great time-saver on installations.

No. 733-H regular Twin Line Strippers\$3.60 Net
No. 744-H Automatic Twin Line strippers\$4.80 Net

Other models available for all size wires—write for catalog Dept. D or see your Distributor.
(DISTRIBUTORS, WRITE FOR DETAILS)

Manufactured by
GENERAL CEMENT MFG. CO. Pat. U.S.A. No. 2313793
RDCKFORD, ILL., U.S.A.



NET PRICE ONLY
\$3.60
REGULAR MODEL

EVERY SERVICEMAN CAN afford SUPERIOR TEST EQUIPMENT



THE NEW MODEL 770— An Accurate Pocket-Size VOLT-OHM MILLIAMMETER

(SENSITIVITY: 1000 OHMS PER VOLT)



Features:

- Compact—measures 3 1/4" x 5 7/8" x 2 1/4"
- Uses latest design 2% accurate 1 Mil. D'Arsonval type meter.
- Same zero adjustment holds for both resistance ranges. It is not necessary to readjust when switching from one resistance range to another. This is an important time-saving feature never before included in a V.O.M. in this price range.
- Housed in round-cornered, molded case.
- Beautiful black etched panel. Depressed letters filled with permanent white, insures long-life even with constant use.

Specifications: 6 A.C. VOLTAGE RANGES: 0-15 30 150/300 1500 3000 volts.
6 D.C. VOLTAGE RANGES: 0-7 1/2 15 75 150 750 1500 volts.
4 D.C. CURRENT RANGES: 0-1 1/2 15 150/Ma. 0-1 1/2 Amps.
2 RESISTANCE RANGES: 0-500 ohms. 0-1 Megohm.

The Model 770 comes complete with self-contained batteries, test leads and all operating instructions. **\$13.90 NET**

We manufacture a complete line of radio test equipment. Write Dept. RE-12 for FREE catalog today!

MFD. BY  **SUPERIOR INSTRUMENTS CO.**
227 Fulton St., New York 7, N. Y.

at your regular jobber

DON'T FORGET
to read the

SPECIAL
SECTION
on

TELEVISION
ASSEMBLY CO.

in next
month's issue

GREYLOCK

A Dependable Name in
RADIO TUBES

GT, Glass & Miniature Types
All Tubes in Individual Cartons

5Y3GT	12AT6	1R5
6AT6	12BA6	1T4
6BA6	12BE6	1U4
6BE6	12K7GT	1S5
6SA7GT	12Q7GT	1S4
6SJ7GT	12SA7	1Q4
6SK7GT	12SK7	1V4
6S7GT	12SQ7	12AU6
6V6GT	25L6GT	12BF6
6X4	25Z6GT	35B5
6X5GT	50B5	35L6GT
12A8GT	50L6	35Z5GT

39c
each

SPECIAL OFFER! All 39c Tubes may be purchased in lots of 100 assorted, at \$35.00 per 100.

5A7	5AU6	6G6G
6AC5	6BH6	6SN7GT
6A15	6B6	12AU7
6A3	6C6	25Z5
6A6	6D6	75
6AJ3	6SL7GT	117Z3

49c
each

1H5GT	19T8	117L7
1N GT	70L7	6L6GA
32L7	84	53

59c
each

SPECIAL!! 6BG6G \$.89
Standard Replacement VOLUME CONTROLS:
All sizes, 1/2" lift, less switch, each \$.24
With SPST switch, each \$.34
With DPST Switch, each \$.39

PM SPEAKERS Less Trans.
1" with Alnico V Magnet \$1.14
1" with Alnico V Magnet \$1.14
1" with Alnico V Magnet \$1.49
3" 1M with plastic cone and 8-oz. Alnico V Magnet \$1.35
3" 1M with Alnico V Magnet \$1.19
WEBSTER AJ1 Pick-up, plastic arm \$1.49

SELENIUM RECTIFIERS
100 Ma. \$.59
77 Ma. \$.49

TERMS: Net C.O.D., F.O.B. N.Y.C. 35c Handling Charge on all orders under \$5.00.
Write for Bargain Catalog C-12

GREYLOCK ELECTRONIC SUPPLY CO.
30 Church Street New York 7, N. Y.

The HOUSE OF A MILLION RADIO PARTS

3" Round Marion 0-1 Ma Basic Meter-Standing Wave Radio \$2.95 ea.
2" Round G.E. 0-1 R.F. Meter \$1.95 ea.
Kit No. 25—25 Assorted 5-10-20 Watt Resistors \$2.95
Kit No. 36—36 Assorted Electrolytic Cond. List \$50.00 \$6.95

SEND FOR BARGAIN BULLETIN C-913

Lifetime SOUND EQUIPMENT CO.
911-913 Jefferson Ave., TOLEDO 2, OHIO

TALK-SING-PLAY OVER ANY RADIO

With the **NEWEST REAL RADIO MIKE!** Attaches in a jiffy—FULL INSTRUCTIONS GIVEN! SWELL FOR "PARTIES"—"GUITAR"—ON OR "KID"—REGULAR NETWORK PROGRAMS OR PUT ON YOUR OWN BROADCASTS! AMAZE YOUR FRIENDS—REAL FUN! LEARN RADIO BROADCASTING! BEAUTIFUL SILVER PLASTIC detachable base—6 ft. wire!

SEND NO MONEY Just pay postman age or send \$2.99 and we pay postage! ORDER your own REAL RADIO MIKE TODAY—NOW! MIDWAY SALES CO. Dept. MRE-12, Kearney, Nebr.

WANTED

W.E. Carrier Telephone and Carrier Telegraph Equipment and components. Filters, repeating coils, transformers, equalizers. Type CF1, CF2, H, C, and other carrier equipment, telephone and telegraph repeaters. **Box DD-1, c/o Radio-Electronics** 25 W. Broadway, New York 7, N. Y.

PEN-OSCIL-LITE

Extremely convenient test oscillator for all radio servicing; alignment. • Small as a pen • Self powered • Range from 700 cycles audio to over 800 megacycles u.h.f. • Output from zero to 125 v. • Low in cost • Used by Signal Corps • Write for information.

GENERAL TEST EQUIPMENT

38 Argyle Ave. Buffalo 9, N. Y.

SPARE PARTS CASES

New radio assemblies packed in foil in wooden cases, clean and dry, "N-1." The government paid from \$189.76 to \$400.00 per case—YOUR PRICE, \$10.00 PER CASE, remittance in full with order. No selection permitted, other than to guarantee up to 7 cases different, to quantity buyers.

Less than 500 cases available: we must move them without delaying for processing. Shipment by Express Collect only. (Weight, approx. 50 lbs. per case).

Laboratories, Hospitals, Universities, Public Utilities, Dealers, Hams and Experimenters—Our Surplus Stocks of instruments, equipment and parts can save you money and fulfill your requirements where commercial sources cannot. State your needs—get on our mailing list!

ENGINEERING ASSOCIATES

Far Hills Branch, Box 26G, Dayton 9, Ohio

RADIO-ELECTRONICS needs more photos of service shops and service benches. We will pay \$6.00 for each 6x8- or 8x10-inch glossy photo accepted. Do not "dress up" your bench, but take a bona-fide photo, preferably with men working.



FLASH THAT VOLTAGE

Turn that knob. Extinguish the neon glow. Instantly read voltage right off dial. MINI-VOLT measures 65 to 600 v. AC. Also DC. Tells whether AC or DC. Virtually burnout-proof. Guaranteed for 10,000 hours' operation. Take-it-easy case. 12" flexible test leads and test prods. A "must" in electrical and radio work. Only \$2.75 postpaid!

INDUSTRIAL DEVICES, INC., EDGEWATER 3, N. J.

CITY	CALL	FREQUENCY
Muncie	WMUN	104.1
New Castle	WCTW	103.1
Shelbyville	WSRK	101.3
South Bend	WSBF	101.3
Terre Haute	WBOW-FM	101.1
Washington	WFML	106.5
Warsaw	WRSW	107.3

CITY	CALL	FREQUENCY
Burlington	KBUR-FM	92.5
Cedar Rapids	KCRK	96.9
Council Bluffs	KFMX	96.1
Davenport	WOC-FM	103.7
Des Moines	KSO-FM	97.3
Des Moines	KRNT-FM	104.5
Des Moines	WHO-FM	100.3
Dubuque	KDTH-FM	100.5
Dubuque	WDBQ	103.3
Fort Dodge	KFMY	102.7
Iowa City	KSUI	91.7
Keokuk	KOKX-FM	102.7
Mason City	KGLO-FM	101.1
Sioux City	KXCJ-FM	94.9
Waterloo	KXEL-FM	105.7

CITY	CALL	FREQUENCY
Garden City	KGAR-FM	99.3
Hutchinson	KIMV	105.7
Hutchinson	KWBW-FM	93.1
Kansas City	KSBS	105.9
Topeka	WIBW-FM	102.5
Topeka	WREN-FM	94.1
Wichita	KFH-FM	100.3

CITY	CALL	FREQUENCY
Bowling Green	WBON	101.1
Henderson	WSON-FM	99.5
Hopkinsville	WHOP-FM	98.7
Lexington	WBKY	91.3
Louisville	WBOX	100.7
Louisville	WHAS	99.7
Louisville	WRXW	95.1
Louisville	WVJS-FM	96.1
Owensboro	WKYC	93.3
Paducah	WPAD-FM	96.9

CITY	CALL	FREQUENCY
Alexandria	KALB-FM	96.9
Alexandria	KPDR-FM	99.7
Baton Rouge	WAFB-FM	104.3
Baton Rouge	WBRL	98.1
Baton Rouge	WLCS-FM	101.1
Baton Rouge	WLSU	91.7
Baton Rouge	WLFM	104.1
Monroe	WRMC	97.1
New Orleans	WSMB-FM	102.7
New Orleans	WTPS-FM	95.7
New Orleans	WWLH	100.3

CITY	CALL	FREQUENCY
Bangor	WGUY-FM	93.1
Lewiston	WCOU-FM	93.9
Portland	WGAN-FM	101.9

CITY	CALL	FREQUENCY
Annapolis	WNAV-FM	99.1
Baltimore	WCAO-FM	102.7
Baltimore	WFBR-FM	101.9
Baltimore	WIFH-FM	104.3
Baltimore	WMAR-FM	97.9
Baltimore	WMCP	94.1
Bradbury Hts.	WBUD	96.7
Frederick	WFMD-FM	101.5
Hagerstown	WJEF-FM	104.7
Salisbury	WBOC-FM	97.5
Silver Spring	WGAY-FM	102.3

CITY	CALL	FREQUENCY
Boston	WBMS-FM	104.1
Boston	WBZ-FM	92.9
Boston	WEEL-FM	103.3
Boston	WHDH-FM	94.5
Boston	WBET-FM	97.7
Brockton	WXHR	96.9
Cambridge	WACE-FM	100.3
Chicopee	WCFR	93.5
Fall River	WSAR-FM	103.7
Fitchburg	WEIM-FM	104.7
Greenfield	WHAI-FM	98.3
Haverhill	WHAV-FM	92.5
Holyoke	WHYN-FM	93.1
Lawrence	WLAW-FM	93.7
Lynn	WLYN-FM	105.5
New Bedford	WFMR	98.1
Pittsfield	WBEC-FM	94.3
Springfield	WBZA-FM	97.1
Springfield	WMAS-FM	94.7
Springfield	WSFL	101.9
West Yarmouth	WOCB-FM	94.3
Worcester	WGTR	99.1
Worcester	WTAG-FM	96.1

CITY	CALL	FREQUENCY
Ann Arbor	WAG-FM	98.7
Ann Arbor	WUOM	91.7
Battle Creek	WEL-FM	102.1
Bay City	WBCM-FM	96.1
Benton Harbor	WHFB-FM	99.9
Detroit	WDR	90.9
Detroit	WJKB-FM	93.1
Detroit	WJLB-FM	97.9
Detroit	WJRF-FM	96.3
Detroit	WJY-FM	97.1
Detroit	WXYJ-FM	101.1
Detroit	WKAR-FM	90.5
East Lansing	WAJL	107.1
Flint	WFRS	92.5
Grand Rapids	WLAV-FM	96.9
Grand Rapids		



NOW! BUILD 15 RADIOS

COMPLETE KIT ONLY... \$14.⁷⁵

**ABSOLUTELY NO KNOWLEDGE OF RADIO NECESSARY
YOU NEED NO ADDITIONAL PARTS!**

THE PROGRESSIVE RADIO KIT is the ONLY COMPLETE KIT

Operates on 110-120 volts AC/DC. Contains everything you need. Instruction Book, Metal Chassis, Tubes, Condensers, Resistors and all other necessary radio parts. The 36-page Instruction Book written by expert radio instructors and engineers teaches you to build radios in a professional manner. The first circuit built is a simple one-tube detector receiver. Each succeeding circuit incorporates new arrangements of detectors, RF and AF Amplifiers. This kit is excellent for learning the principles of receiver, transmitter and amplifier design. It is used in many radio schools and colleges. All of the commonly-used detectors are used, including diode, grid leak, plate and infinite-impedance. The transmitters are designed with Hartley and Armstrong oscillators, using screen-grid and control-grid modulation. Both vacuum tube and selenium rectification

are employed in these circuits. The circuits are designed to provide excellent performance. Altogether, fifteen circuits are constructed, including 11 receivers, 1 audio amplifier, and 3 transmitters. The sets start with simple circuits of 1 tube plus rectifier, gradually grow more complex, and finish with several examples of radio sets using three tubes plus rectifier.

PROGRESSIVE RADIO KIT . . . ONLY \$14.75

SPECIAL FREE OFFER

Electrical and Radio Tester sent absolutely FREE with each Progressive Radio Kit. PLUS FREE membership in Progressive Radio Club. Entitles you to free expert advice and consultation service with licensed radio technicians. Write for further information or ORDER your KIT NOW!

WE PAY POSTAGE ON PREPAID ORDERS

C.O.D. ORDERS SHIPPED COLLECT

ATTENTION RADIOMEN!! Send for Your FREE DEALERS catalog and Price List Today!

• RADIO KITS • AMPLIFIER KITS • FM COIL & CONDENSER KITS • RESISTOR KITS • CONDENSER KITS • RADIO TOOL KITS • FM-AM CHASSIS • SPEAKERS • RADIO PARTS • PORTABLE RADIOS • CAMERA-RADIOS • TUBES • AUTO RADIOS • HOME RADIOS • TELEVISION SETS • TELEVISION CABINETS • TEST EQUIPMENT • FM TUNERS

PROGRESSIVE ELECTRONICS CO.
DEPT. RE-20 497 UNION AVE. BROOKLYN 11, N. Y.

HOW TO GET THE MOST

from only

S-S-S

BASIC TEST EQUIPMENT

Servicing by Signal Substitution

The Simple, Modern, Dynamic Speed approach to receiver alignment and adjustment problems, FM-AM-TV.

- Nothing complex to learn
- No extra equipment to purchase
- Universal — non-obsolete
- Employs only Basic Test Equipment



S-S-S tells HOW — In simple, direct language.

New 9th edition now off the press. 100 pages of valuable information.

Available from all leading radio parts and equipment distributors or directly from factory at only 40¢ per copy.

PRECISION APPARATUS COMPANY, Inc. • 92-27 Horace Harding Blvd., Elmhurst 4, N. Y.

WHERE RADIOMEN MEET, EAT and SLEEP

Visit the FAMOUS FIESTA LOUNGE Renowned for Fine Food



HOTEL STRAND

Atlantic City's Hotel of Distinction

The Ideal Hotel for Rest and Relaxation • Beautiful Rooms • Salt Water Baths • Glass inclosed Sun Porches • Open Sun Decks atop • Delightful Cuisine • Garage on premises. • Moderate Rate Schedule.

OPEN ALL YEAR Exclusive Pennsylvania Ave. and Boardwalk

CITY	CALL	FREQUENCY	CITY	CALL	FREQUENCY
Fargo	NORTH DAKOTA KVNJ-FM	92.3	Cleveland	WEWS-FM	102.1
Akron	OHIO WAKR-FM	97.5	Cleveland	WHK	100.7
Alliance	WFAH	101.7	Cleveland	WJW-FM	104.1
Ashland	WATG	101.3	Cleveland Hts.	WSRS-FM	95.3
Bellaire	WTRF-FM	100.5	Columbus	WCOL-FM	92.3
Canton	WAND-FM	92.5	Columbus	WELD	97.1
Canton	WCMW-FM	94.9	Columbus	WHKH	98.7
Canton	WHBC-FM	94.1	Dayton	WHIO-FM	99.1
Cincinnati	WCST-FM	101.9	Elvria	WEOL-FM	107.3
Cincinnati	WLWA	101.1	Findlay	WFIN-FM	100.5
Cincinnati	WSAI-FM	102.7	Fostoria	WFOB	105.5
Cleveland	WBOE	90.3	Fremont	WFRO	99.3
			Hamilton	WMOH-FM	103.5
			Lakewood	WLAL	104.9
			Lima	WIMA-FM	102.1
			Lima	WLOK-FM	103.3

CITY	CALL	FREQUENCY
Newark	WCLT	100.3
Portsmouth	WPAY-FM	104.1
Springfield	WJEM	103.9
Steubenville	WSTV-FM	103.5
Tiffin	WTFM	98.3
Toledo	WTD5	91.3
Toledo	WTRT	99.9
Toledo	WSPD-FM	101.5
Wooster	WWST-FM	104.5
Youngstown	WFMJ-FM	105.1
Youngstown	WKDN-FM	98.9
Armore	OKLAHOMA KVSQ-FM	93.7
Durant	KSEQ-FM	107.3
Enid	KCRC-FM	102.7
Muskogee	KMUS	101.5
Muskogee	KBIX-FM	98.5
Norman	KOKU	90.9
Oklahoma City	KOCY-FM	94.7
Oklahoma City	KOKH	90.1
Oklahoma City	KOMA-FM	105.9
Oklahoma City	KTOK-FM	104.3
Oklahoma City	WKY-FM	98.9
Stillwater	KOAG-FM	91.7
Stillwater	KSPI-FM	93.9
Tulsa	KAKC-FM	95.5
Tulsa	KWGS	90.5
Tulsa	KTUL-FM	97.1
Albany	OREGON KWIL-FM	101.7
Eugene	KRYM	90.1
Eugene	KUGN-FM	99.1
Grants Pass	KGPO	96.9
Portland	KGW-FM	100.3
Portland	KOIN-FM	101.1
Portland	KPFM	97.1
Portland	KPOJ-FM	98.7
Portland	KPRO	95.5
Allentown	PENNSYLVANIA WFMZ	95.9
Allentown	WKAP-FM	100.7
Allentown	WSAN-FM	99.0
Altoona	WFBG-FM	103.7
Altoona	WAPJ	96.5
Bethlehem	WEST-FM	107.9
Bethlehem	WGPA-FM	95.1
Bradford	WESB-FM	97.5
Butler	WISR-FM	97.7
Chambersburg	WCHA-FM	95.5
DuBois	WCED-FM	102.1
Easton	WEEZ	98.3
Erie	WERC-FM	99.9
Erie	WLEU-FM	97.9
Harrisburg	WABX	100.9
Harrisburg	WHP-FM	97.3
Johnstown	WARD-FM	105.3
Johnstown	WJAC-FM	95.5
Lancaster	WGAL-FM	101.3
Lancaster	WLAN-FM	96.9
Lebanon	WLAB	104.1
Lebanon	WLBK-FM	100.1
Lewistown	WLTN	97.9
McKeesport	WMCK-FM	104.9
Meadville	WMGW-FM	100.3
New Castle	WKST-FM	101.1
Philadelphia	KYV-FM	92.5
Philadelphia	WCAU-FM	98.1
Philadelphia	WFIL-FM	102.1
Philadelphia	WIBG-FM	94.1
Philadelphia	WIP-FM	93.3
Philadelphia	WJUN	91.7
Philadelphia	WPEN-FM	102.9
Pittsburgh	KDKA-FM	92.9
Pittsburgh	KQV-FM	98.1
Pittsburgh	WCAE-FM	96.1
Pittsburgh	WJAS-FM	99.7
Pittsburgh	WKJF	93.7
Pittsburgh	WMOT	94.5
Pottsville	WPAM-FM	95.5
Reading	WEEU-FM	92.9
Scranton	WARM-FM	105.7
Sharon	WPIC-FM	102.9
State College	WEHR	90.9
Sunbury	WKOK-FM	94.1
Uniontown	WMBS-FM	105.7
Uniontown	WNIO	106.5
Warren	WNAE-FM	92.1
West Chester	WWCH	91.3
Wilkes-Barre	WBRE-FM	98.5
Wilkes-Barre	WIZZ	103.3
Williamsport	WRAC-FM	100.3
York	WRZE	98.5
York	WSBA-FM	103.3
Providence	RHODE ISLAND WJAR-FM	95.5
Providence	WLIV	107.7
Providence	WPJB	105.1
Providence	WPRO-FM	92.3
Providence	WPPL	91.5
Anderson	SOUTH CAROLINA WCAC	101.1
Charleston	WCSC-FM	96.9
Charleston	WTMA-FM	95.1
Columbia	WIS-FM	94.5
Greenville	WESC-FM	92.5
Greenville	WFBC-FM	93.7
Greenville	WMRC-FM	94.9
Greenville	WCRS-FM	95.7
Spartanburg	WDXY	100.5
Spartanburg	WSPA-FM	98.9
Bristol	TENNESSEE WOPI-FM	96.9

CITY	CALL	FREQUENCY
Chattanooga	WAPQ-FM	94.7
Chattanooga	WYUM	98.1
Clarksville	WCWC	106.7
Jackson	WTJS-FM	100.7
Johnson City	WJHL-FM	100.7
Kingsport	WKPT-FM	98.5
Knoxville	WKPB	93.3
Knoxville	WRQL-FM	97.3
Memphis	WHMM-FM	106.9
Memphis	WMCB	99.7
Nashville	WSIX-FM	97.5
Nashville	WSM-FM	103.3

TEXAS		
Abilene	KRBC-FM	96.9
Amarillo	KGNC-FM	104.3
Beaumont	KRIC-FM	99.5
Belton	KMFB	97.1
Dallas	KIXL-FM	104.5
Dallas	KRLD-FM	92.5
Dallas	WFAA-FM	97.9
Denton	KDNT-FM	105.1
Edinburg	KURV-FM	104.9
Harlingen	KGBS-FM	94.7
Houston	KOPY	97.9
Houston	KPRC-FM	102.9
Houston	KTRH-FM	101.1
Houston	KUHF	91.7
Houston	KXYZ-FM	96.5
Lubbock	KFYO-FM	99.5
Lufkin	KRBA-FM	95.5
San Angelo	KGKL-FM	94.5
San Antonio	KISS	99.5
San Antonio	KONO-FM	92.9
San Antonio	KTSA-FM	104.1
San Antonio	KYFM	101.5
San Antonio	WOAI-FM	102.5
Texarkana	KCMC-FM	98.1
Tyler	KGBB-FM	101.5
Vernon	KYWC-FM	98.7
Wichita Falls	KTRN	97.3
Wichita Falls	KWFT-FM	99.9

UTAH		
Ogden	KOPP-FM	103.9
Salt Lake City	KDYL-FM	98.7
Salt Lake City	KSL-FM	100.3

VIRGINIA		
Arlington	WARL-FM	105.5
Danville	WBTM-FM	97.9
Harrisonburg	WSVA-FM	100.7
Lynchburg	WLVA	97.5
Lynchburg	WWOD-FM	107.9
Newport News	WGH-FM	96.5
Norfolk	WARY	105.3
Norfolk	WRVC	102.5
Norfolk	WTAR-FM	97.3
Portsmouth	WSAP-FM	99.7
Richmond	WCOD	98.1
Richmond	WLEE-FM	102.9
Richmond	WRNL-FM	102.1
Richmond	WRVB	94.5
Roanoke	WDBJ-FM	94.9
Roanoke	WDSL-FM	99.1
Roanoke	WROV-FM	103.7
Suffolk	WLPM-FM	107.7
Winchester	WINC-FM	92.5

WASHINGTON		
Longview	KWLK-FM	103.9
Seattle	KING-FM	94.9
Seattle	KRSC-FM	98.1
Seattle	KIRO-FM	100.7
Tacoma	KTNT	97.3

WEST VIRGINIA		
Beckley	WCFC	101.3
Beckley	WJLS-FM	99.5
Bluefield	WHIS-FM	104.5
Clarksburg	WPDX-FM	95.1
Huntington	WHTN-FM	100.5
Huntington	WPLH-FM	102.5
Logan	WLOG-FM	103.3
Morgantown	WAJR-FM	99.3
Oak Hill	WOAY-FM	94.1
Wheeling	WKWK-FM	97.3
Wheeling	WWYA-FM	98.7

WISCONSIN		
Beloit	W8NB	107.3
Chilton	WHKW	89.9
Delafield	WHAD	90.7
Eau Claire	WEAU-FM	94.1
Green Bay	WJPG-FM	101.1
Green Bay	WTAQ-FM	102.5
Greenfield	WWCF	94.9
Janesville	WCLO-FM	99.9
LaCrosse	WKBH-FM	93.1
Madison	WFOV	104.9
Madison	WHA-FM	88.7
Madison	WIBA-FM	101.5
Madison	WISC-FM	99.9
Marshfield	WDLB-FM	103.7
Merrill	WLIN	100.7
Milwaukee	WEMP-FM	94.1
Milwaukee	WISN-FM	102.9
Milwaukee	WTMJ-FM	93.3
Neeah	WNAM-FM	98.5
Oshkosh	WOSH-FM	92.9
Racine	WRJN-FM	100.7
Rice Lake	WJMC-FM	96.3
Superior	WEBC	92.3
Waukesha	WAUX-FM	95.3
Wausau	WHSF	89.1
Wausau	WSAU-FM	95.5
Wisconsin Rapids	WFHR-FM	103.3

SELSYN TRANSMITTER AND INDICATOR

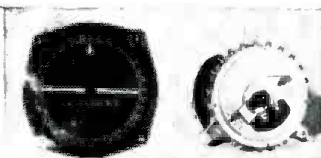

Ideal as Radio Beam position indicator, for Ham, Television, or commercial use. Complete with 1-82 five inch indicator, Autosyn Trans, 12 Volt 60 Cycle transformer, and wiring instructions. **\$7.95**
 Price: NEW
 1-82 Indicator only\$4.95

ANTENNA MAST MOUNT

Multiple Mast Mount—Can be mounted on Chimneys, on gable, slanted, or flat roofs or on sides or corners of brick or frame walls. Ideal for holding all popular types of Television and FM Antennas in sizes up to 1 1/2" diameter. Made of aluminum, with steel hardware, plated. Complete with banding for chimney mounting. **\$4.50**
 Price
 Less banding\$3.00

DYNAMOTORS—INVERTERS—MOTORS

MG-149F INVERTER, Input 24 Volt DC; Output 26 Volts 100 cycle 250 VA or 12 Volt input, output 400 Cycle 400VA. Reconditioned and tested **\$9.95**
MOBILE DYNAMOTOR 9 Volt input, output 405 Volt 95 MA, 6 Volt input/output 280 Volt 95 MA. DM635X. New **\$3.95**
PM DYNAMOTOR—12 or 24 Volt input, output 500 Volt 50 MA, 6 Volt input, output 240 Volt 50 MA. New **\$1.95**
MOTOR—6 or 12 Volt AC-DC, Heavy Duty reversible motor with 5/16" x 7/16" shaft. **\$2.95**
 New
MOTOR—6 Volt AC-DC Motor ideal for auto fans, models, etc. Shaft 1/4" x 7/8". **\$1.50**
 Used, tested
 ADDRESS DEPT. RE • Prices F.O.B., Lima, Ohio • 25% DEPOSIT On C.O.D. Orders

COMMAND RECEIVER—AC POWER SUPPLY AND SPEAKER

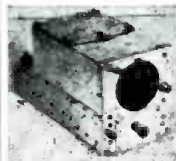

BC 454 COMMAND RECEIVER
 3 to 6 Megacycles. Covers 75 and 80 meter amateur band. Price with selective matics **\$6.95**
 new
TUNING CRANK for Comm. Receivers 65c ea.

AC POWER SUPPLY AND SPEAKER

Completely wired power supply and speaker, with volume control C W and on and off switch, housed in metal cabinet, size 1 1/2" x 5 1/4" x 4 1/2". For above receiver or any other type command receiver, ready to plug into receiver or rack, and 110 Volt 60 Cycle line. Price completely wired **\$14.95**
 Price kit of parts only **9.95**



B 19 MARK II TRANSMITTING AND RECEIVING SETS

COMPLETE with all spare parts including 15 spare tubes. Set ready to operate from 12 to 24 Volts DC. Frequency range 2 to 8 Mc (40 and 80 meters). Separate 235 Mc Trans. & Rec and two tube amplifier. Price: New **\$59.50**

MARKER BEACON RECEIVERS

DC-1023 Receives 75 Mc. Modulated signal, can be varied from 62 to 80 Mc. Operates self-contained sensitive relay that can be used to operate equipment from remote point. Needs only 12 to 14 Volts DC for filament and plate voltage. Complete with 4 tubes, selenium, shock mounted, size 5 3/8" x 5 3/8" x 3 7/16". New, in original boxes. **\$3.50**
 Price

INTERPHONE AMPLIFIER BC-347

Army Aircraft Type; uses GFR Tube. Contains two (2) Midget High Fidelity UTC output transformers (2 1/2" x 1 1/4"). Input 200 ohm to single or push pull Grid. Output 200 ohm from single or push pull plate. plus resistors, condensers, etc. Completely enclosed. Size 2 1/2" x 4" x 6". Less Tube—only each **79c**
 Or 3 for **\$2.00**

FAIR RADIO SALES

132 SOUTH MAIN ST. LIMA, OHIO

HANDSET HANGERS
 in black crackle finish
\$1.95 ea.

REST-A-PHONE
 Snaps on your receiver in 5 seconds!
 Balances on the shoulder
 postpaid **\$1.69 ea.**

The F-1 or New Model Receiver requires an F-1 Rest-A-Phone.
 The E-1 or Old Model Receiver requires an E-1 Rest-A-Phone.

Send 20% Deposit, Balance C.O.D.
OFFENBACH & REIMUS CO.
 372 Ellis St., San Francisco 2, Calif.

32 FACT-PACKED PAGES

Elements of MAGNETIC TAPE RECORDING and 999 Applications by A. C. SHANEY

Only 25c
AMPLIFIER CORP. OF AMERICA
 398-10 Broadway New York 13, N. Y.

Prepare for a Good Job Now in
RADIO TELEVISION F.M.—ELECTRONICS

LEARN QUICKLY IN THE GREAT SHOPS OF
COYNE

NOT A "HOME STUDY" COURSE

Get ready for a better job, bigger pay NOW in Radio-Television. Cash in with "All-around" knowledge of Radio—FM.—Television. Train on actual equipment not by "Home-study". You learn quickly at COYNE because it's a real SHOP course!

G. I. APPROVED... also Finance Plan for NON-VETERANS. Don't let lack of cash hold you back. Many earn while learning. Special plan for men of draft age. Get facts today!

SEND COUPON FOR FREE BOOK
 Send at once for Big Free Book on Radio, Television, F. M., Electronics and facts about our Finance Plan.

MAIL THIS COUPON TODAY

Coyne Electrical and Radio School
 500 S. Paulina St., Dept. 98-8H, Chicago 12, Ill.
 Please send Big FREE Book and complete details.

NAME

STREET

CITY STATE

TINY RADIO!

Red plastic case. No tubes, batteries or electric "plugs" needed! Guaranteed to receive local stations. Only \$3.99 (ok. Mo. cash) postpaid or send only \$1.00 and pay \$3.99 C.O.D. Complete ready to play on easy connection. With Personal phone. Get your tiny radio now!

MIDWAY SALES CO., DEPT. TRS-12, KEARNEY, NEBR.

You Can't Match these
MID-AMERICA Values!

Transformer Scoops!

Transformers listed are full-shell type, upright mounting. Color coded leads. Brand new! Quantities are limited—so order now!

MA-2510—Power Transformer 850 VCT, 200 MA; 5V, 3A; and 6.3V, 5A, 4 1/2"
x 4" x 3 1/2". Regular list \$12.75. Now only, \$4.95 ea.

MA-2523—Driver Transformer 6F6 to 6L6, Class AB2. Rated 40 MA. Primary current, 3" x 2 1/2" x 3". A \$3.75 value. Mid-America's value price..... \$1.69 ea.

MA-2521—Filament Transformer 115 V, 6-cycle primary, 6.3V, 3A secondary, 3" x 2 1/2" x 2 1/2"..... \$1.49 ea.



Amazing FM Antenna

Model A-100 for use indoors—eliminates trouble of erecting outside antenna. Tunes 88-108 MC band with excellent signal gain. May be mounted on wall or out of sight under rug. Complete with twin lead-in cable; merely connect to receiver antenna posts. Brand new in original factory cartons. Shipping wt. 1 lb..... \$1.49 ea.

SERVICEMAN SPECIALS

MA-2169 Antenna loop for AC-DC sets.....15c
MA-3303 6-ft rubber line cord with plug.....12c

Standard Brand Electrolytic Condensers

59c each, 10 for \$5.49

MA-842 16-16 mfd. 450 WVDC
MA-886 20-20 mfd. 300 WVDC
MA-839 40-40 mfd. 150 WVDC

Chokes and Transformers

MA-2526 6 henry, 150 MA, 150 ohm choke...\$1.29
MA-2530 600 VCT, 50 MA, 6.3V, 2A, 5V, 2A transformer (half-shell mtg.)... 2.09
MA-1290 15 henry, 50 MA, 120 ohm choke... .49
MA-1205 Universal output transformer for single p.p. or parallel tubes; rated 12 watts (strap mtg.)... 1.19
MA-2525 600 VCT, 100 MA; 6.3V, 3A; 5V, 3A transformer (upright mtg.)... 2.79

Volume Controls with Switches

39c each, 10 for \$3.49

MA-1141 100,000 ohm MA-1153 500,000 ohm
MA-1107 250,000 ohm MA-1164 1 megohm
MA-1134 350,000 ohm MA-1105 2.5 megohm

PM Speakers

MA-2232 3 1/2", 1.47 oz. Alnico 5.....\$1.29
MA-2214 3", 1.47 oz. Alnico 5..... 1.29
MA-2229-1 6", 1.68 oz. Alnico 5..... 1.69
MA-2267 8", 21 oz. Alnico 3..... 3.79
MA-2268 12", 21 oz. Alnico 3..... 6.50

TERRIFIC SAVINGS ON CERAMIC GRID CAPS

5/8" clamp to fit 807, 2X2 and other popular tubes. Made by a famous manufacturer. Regular 21c. Get your share while they last at this sensational low price. MA-2234, 6 for 79c.



Order from this Ad

Quantities on above-listed items are strictly limited! You must act fast to make sure you get what you want. Send 25% deposit. Pay balance plus postage on delivery. Get your name and address on Mid-America's select mailing list to receive monthly bazaar bulletins that give you first crack at the latest, greatest, money-saving buys in radio parts, electronic equipment, tubes, etc. Send orders and mailing list data to Desk RE-128

MID-AMERICA CO. Inc.

2412 S. Michigan Avenue
Chicago 16, Ill.

SETTING A.F. OSCILLATORS

Many a constructor of audio test generators is confronted with the problem of calibration. For best results another calibrated oscillator should be used.

If the builder is a ham or knows one, he may have access to a surplus BC-221 r.f. frequency meter, which can be used very nicely for the a.f. calibration.

Feed the audio output of the frequency meter into the vertical input of an oscilloscope, and the output of the audio generator into the horizontal input. Let the meter warm up for at least 15 minutes; then switch it to the low band and set it to zero beat with the built-in crystal standard.

Now tune the variable-frequency oscillator in the frequency meter to various frequencies differing from the crystal comparison frequency by amounts from zero to 10 kc. The difference between the crystal check frequency and the v.f.o. frequency will be the audio-frequency tone.

Compare the a.f. generator frequency to that put out by the frequency meter. When they are equal, the scope will show a more or less perfect letter O. The generator scale can be marked at each point of comparison.

IGINIO CORRENTE,
Bayonne, N. J.

STARTING FLUORESCENTS

Here is a method for starting burned-out fluorescent lamps. Old lamps can be used indefinitely.

The burning out of the lamp means that one or both of the filaments has opened. The filaments heat the gas in the tube so that they will not need a higher starting voltage than is available from the 117-volt lines.

The drawing illustrates the method of starting lamps with open cathodes. An ignition coil and interrupter create a

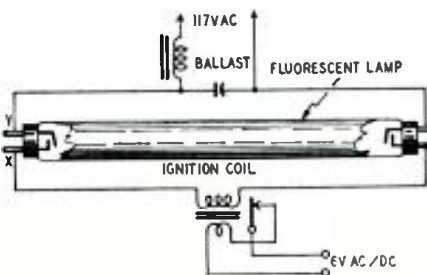

high-voltage a.c. This ionizes the gas sufficiently to allow the 117-volt line current to keep the tube lit. After the lamp is started, the coil can be removed.

DONALD G. BERLYER,
Ballarat, Australia

CRYSTAL HOLDER

A clip-type fuse holder for 3AG-size fuses makes an excellent holder for the negative terminal of the 1N21 or 1N27 silicon crystals which are available on the surplus market. A tube-pin clip from an octal wafer socket is a good connector for the positive end.

HARRY MANDEL,
Brooklyn, N. Y.

S-METER

I had a 0-10-ma meter which I wanted to use as an S-meter in an ordinary home receiver. The set used two 6K7's as i.f. amplifiers. Both cathodes were connected together and to ground.

I inserted the meter between the cathodes and ground, as the diagram indicates. The 50-ohm rheostat is used

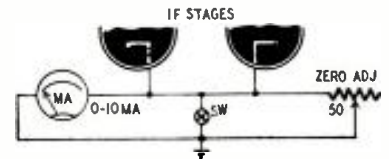

for zero adjustment. The switch bypasses the meter and reconnects the cathodes directly to ground when no meter indication is desired.

If the i.f. tubes in your receiver have cathode-bias resistors, place the meter between their ground ends and ground. Be sure bypass condensers are grounded.

JOHN A. BISHOP,
Transvaal, South Africa

WINDOW ANTENNA

My landlord doesn't allow antennas on the roof of my apartment house (although he had just installed a new television receiver) so I used the scheme shown in the drawing.

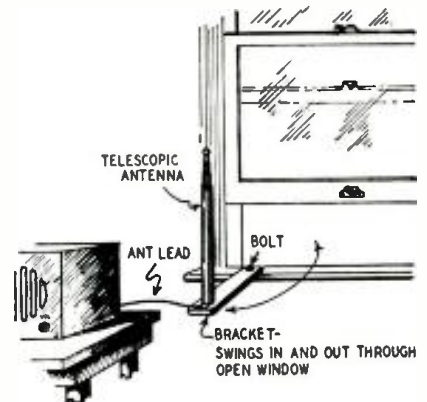

The antenna is a 10-foot collapsible rod type, obtained from surplus. It is mounted on a strip of wood. The other end of the strip is bolted to the window sill.

When I am ready to go on the air, I swing the strip around so that the antenna is outside the window. The antenna is then raised.

I am using this antenna on 10 meters with very good results. I see no reason why it couldn't be used as well on 6 and 2 meters.

G. SAMKOFKY, W2YSF
Brooklyn, N. Y.

CHEMICAL CONTAINERS

Many radio preparations, such as chassis cleaner, come in bottles without applicators. Clean out old liquid shoe polish bottles and put the solutions in them. The applicator furnished for the shoe polish can then be used for the chemicals.

WILLIAM MUESSIG, JR.,
Aurora, Ore.

New

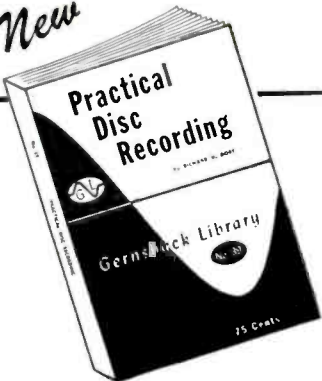

PRACTICAL DISC RECORDING

Answers Your Questions

PRACTICAL INFORMATION

Here is the book that thousands of radio enthusiasts have been waiting for.

Whether you're interested in amateur or professional recording, you'll find PRACTICAL DISC RECORDING by Richard H. Dorf invaluable. It not only tells you how to make successful records, but in addition each important recording component is given a full chapter, explaining its purpose, and what features to look for when buying.

You'll like this book for many reasons. Without waste of words, it gets right down to business on the first page. It tells you what you need to make good records and how to do it by using any type equipment—from the simplest to the most expensive—depending on your purpose and pocketbook. You will find all the practical phases of recording covered as well as the underlying principles.

FILLED WITH FACTS

Chapter 1 discusses the various components which make up the complete system. Chapters 2 to 5 go into the practical details of the selection and use of discs, motors and turntables, feed mechanisms and cutters. Chapter 6 is a comprehensive explanation of constant amplitude and constant velocity recording, the two fundamental recording characteristics on which all recording is based. Chapter 7 covers stylus selection. In Chapter 8 the various sound sources (microphones, radio tuners, etc.) are discussed. A feature is the handy chart of characteristics of different types of microphones. Chapter 9 discusses the all-important amplifier. Circuits of several practical amplifiers are given. In Chapters 10 thru 13, you'll find explained the detailed techniques of making good records. All the fine points of adjustment, equalization, microphone placement and microphone techniques, and a whole chapter on dubbing. Chapter 14 is a concise summary of common troubles in recording, and how to overcome them. The book ends with a comprehensive glossary of recording terms.

96 PAGES, 82 ILLUSTRATIONS

Only 75c

See your radio parts jobber today or order direct.

SEE COUPON BELOW

CLIP AND MAIL

RADCRAFT PUBLICATIONS, INC.,
Dept. 12-8
25 West Broadway, New York 7, N. Y.

Send me PRACTICAL DISC RECORDING I enclose 75c.

Your Name _____
(Print clearly)

Address _____

Jobber's Name _____

Address _____

ALUMINUM DISCS

Every recordist uses some blank discs for making test cuts. Instead of throwing these away after they are used, immerse them in hot water for several minutes, then peel off the recording lacquer. The shiny aluminum disc that emerges will be useful for making small chassis, shields, and separators. The lady of the house will find them useful, too, for serving canapes or for use as coasters for plants and flower-pots.

JOHN ANTHONY TAGLIABUE,
Union City, N. J.

PILOT LAMP FUSE

A shorted first filter condenser in a receiver power supply usually causes the rectifier tube to burn out, necessitating an expensive replacement. To prevent this, I place a pilot lamp in series with the rectifier cathode and the input to the filter.

In normal operation, the lamp will make a very good pilot. If the first filter (or any later component which is across the power supply) shorts, the excessive current drawn by the lamp will burn it out. It thus acts as a fuse, protecting the rectifier tube.

The lamp chosen should be a 6-volt one, with a current rating somewhat higher than the total current drawn by the receiver and filter (as determined with an ammeter placed temporarily where the lamp will go).

JEAN S. BASTIN,
Roux, Belgium

SPEAKER REPLACEMENT

The cone of the electrodynamic speaker in my table-model receiver was damaged beyond repair, and I wanted to use a PM speaker as the replacement.

I removed the field coil (with its core and housing) and output transformer from the old speaker, leaving all leads connected, and fastened the field coil under the chassis with solder.

The new PM was installed, and the old output transformer mounted on it. I connected the new voice coil to the proper transformer terminals.

This avoided the necessity for procuring a new electrodynamic speaker, since the old field coil is still in the circuit, acting as a power-supply choke, just as it did before.

JOHN R. HOOPER,
Eastport, Me.

TRANSFORMER WINDING

When winding a transformer with small wire, it is usually quite a problem to keep the windings in place during the winding process. Masking tape will solve the problem. The tape is wrapped around the form, gummy side up, and each turn sticks to the tape.

Masking tape is also useful where the person winding the coil wants to stop in the middle of the job for any reason. The wire already wound will remain in place until the work is resumed.

JOHN E. KENT,
Waynesboro, Va.

A Remarkable NEW LINE

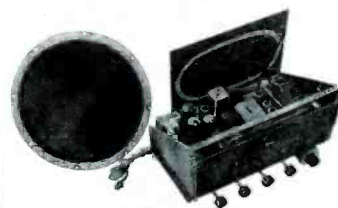

Espey Model 511

High QUALITY
High POWER

Custom-Built

AM-FM Chassis

Like every other model in the complete ESPEY line of replacement receivers, and FM Tuners, the Model 511 AM-FM chassis (illustrated) is the last word in modern engineering in the electronics field. Featuring 12 tubes plus Rectifier and Tuning Indicator, it is Drift Compensated, and is supplied complete with all antennas, 25 watt speaker, and all hardware. Its low price assures high profits for you in the growing replacement field. Write today to Dept. C-11 for complete details of this expanding profitable market!

ESPEY MFG. CO., Inc.

528 East 72nd Street
New York 21, N. Y.

"Established—1928"

BRAND NEW SURPLUS! GUARANTEED!

3/4 RPM, HI-TORQUE
ELECTRIC MOTOR



\$2.85

Plus
40c
Postage
and
Handling

- Operates on 110V AC, 60-cycles.
- (Requires only 1/2 MFD condenser.)
- Reversible. No Free Swing. Quiet.
- With Full Instructions.
- FOR ROTATING HAM, FM, TELEVISION ANTENNAS AND MANY OTHER USES.

BARGAIN RADIO, Dept. BR-2

249 N. Juanita Los Angeles 4, California

TRANSMITTING *Mica* CONDENSERS

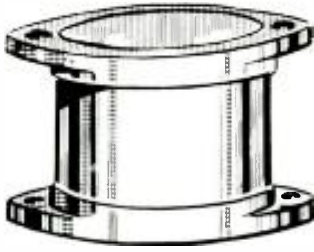

STYLE "A"



STYLE "AA"

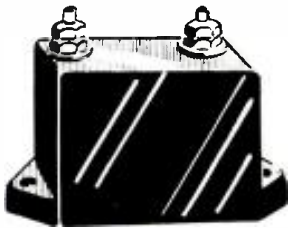

STYLE "B"



STYLE "C"

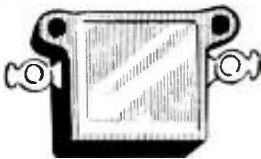

STYLE "D"

SPECIAL LOW PRICES FOR IMMEDIATE SALE AND DELIVERY

We have literally hundreds of thousands of these top quality standard type transmitting mica condensers in stock for immediate delivery at a fraction of their original cost. Every condenser is brand new and carries the name of a fine nationally known manufacturer.

Despite the unusually low prices, these mica condensers, like all Wells Components, are fully guaranteed. Be sure to order sufficient quantities for your requirements.

Cap Mfd	Wrkg. Volt.	Price Each	Cap Mfd	Wrkg. Volt.	Price Each	Cap Mfd	Wrkg. Volt.	Price Each	Cap Mfd	Wrkg. Volt.	Price Each
STYLE "AA" CONDENSERS			STYLE "C" CONDENSERS			STYLE "D" CONDENSERS					
.04	1000	\$3.50	.01	2500	1.60	.005	1250	.45	.001	600	.25
.02	3000	4.50	.01	5000	1.95	.005	600	.35	.0012	600	.30
.002	35000	15.00	.0125	6000	2.00	.0051	2500	.65	.0015	1200	.35
			.02	3000	1.70	.0051	1200	.45	.0018	1200	.35
			.025	2500	1.60	.0056	2500	.65	.002	2500	.40
			.047	2500	1.75	.0056	1200	.45	.002	1200	.35
						.006	2500	.65	.002	600	.25
STYLE "A" CONDENSERS			STYLE "C" CONDENSERS			STYLE "D" CONDENSERS					
25 MMFD	10,000	\$1.65	.000005	2500	\$0.40	.006	1200	.45	.0022	2500	.40
			.00005	2500	.40	.0068	1200	.55	.0022	1200	.30
			.0001	2500	.40	.007	500	.35	.0022	600	.25
			.0001	1250	.35	.008	1200	.45	.0024	1200	.25
			.00015	600	.25	.009	600	.50	.0025	2500	.40
			.00015	2500	.40	.01	2500	.60	.0025	1200	.30
			.00015	1250	.35	.01	1250	.45	.0027	1200	.30
			.000175	2500	.40	.01	600	.40	.003	1200	.30
			.000175	1500	.35	.015	1250	.55	.003	2000	.40
			.0002	2500	.40	.015	600	.35	.00375	1000	.40
			.0002	1500	.35	.0175	1200	.45	.0039	1200	.40
			.0002	600	.25	.02	2500	.65	.004	2500	.45
			.00022	2500	.45	.02	1250	.45	.004	1200	.35
			.00022	1250	.35	.02	600	.35	.004	600	.25
			.00024	2500	.45	.025	1250	.55	.0044	600	.25
			.00025	2500	.45	.03	1200	.50	.0043	1200	.35
			.00025	1200	.35	.04	1200	.55	.0045	600	.30
			.0003	2500	.45	.04	1000	.45	.0047	2500	.40
			.00039	2500	.50	.04	600	.35	.0047	1200	.30
			.0004	2500	.45	.047	1200	.50	.005	2500	.40
			.0004	1200	.35	.047	600	.40	.005	1250	.30
			.0005	2500	.45	.056	1000	.55	.005	600	.25
			.00051	2500	.55	.06	1000	.50	.0051	1200	.35
			.00056	2500	.55	.073	500	.40	.0051	600	.30
			.000575	1500	.60	.09	1000	.55	.0056	1200	.35
			.0006	1250	.45	.09	600	.45	.0056	600	.30
			.0007	1250	.45	.1	1000	.60	.006	1200	.35
			.0008	1250	.45	.1	600	.45	.006	600	.25
			.0008	1000	.35				.0068	1200	.35
			.00085	1200	.40				.007	600	.30
			.001	2500	.55				.008	1200	.35
			.001	1200	.40				.008	600	.30
			.001	600	.35				.009	600	.30
			.0011	2500	.55				.01	1250	.40
			.0012	1250	.50				.01	600	.30
			.00125	1200	.45				.01	2500	.50
			.0015	1200	.45				.015	1250	.40
			.0018	1200	.50				.015	600	.30
			.0015	1200	.45				.014	600	.35
			.002	1200	.45				.0175	600	.40
			.002	2500	.55				.02	2500	.50
			.0022	2500	.60				.02	1200	.35
			.0022	1200	.45				.02	600	.25
			.0024	1200	.50				.022	1200	.35
			.0025	1250	.50				.025	1200	.35
			.0025	1250	.55				.025	600	.25
			.00275	1200	.60				.03	1200	.35
			.003	1200	.55				.033	1200	.35
			.0035	2500	.60				.04	1000	.35
			.00375	2500	.65				.04	600	.30
			.00375	1000	.45				.047	1200	.40
			.0039	1250	.55				.047	600	.30
			.004	2500	.60				.056	1000	.35
			.004	1250	.45				.06	1000	.40
			.0043	2500	.65				.073	500	.30
			.0045	1000	.45				.09	1000	.45
			.0047	1250	.55				.09	600	.35
			.0046	500	.45				.1	1000	.50
			.005	2500	.60				.1	600	.35

This is only a partial listing. Write or wire for information on types not shown and for receiving set micas and silver micas.

We advise distributors to order immediately from this ad. Our standard jobber arrangement applies.

Manufacturers and Distributors: Write for our complete Mica Condenser Listing No. 103A.



320 N. LA SALLE ST. DEPT. Y, CHICAGO 10 ILL.
RADIO-ELECTRONICS for DECEMBER, 1948

New

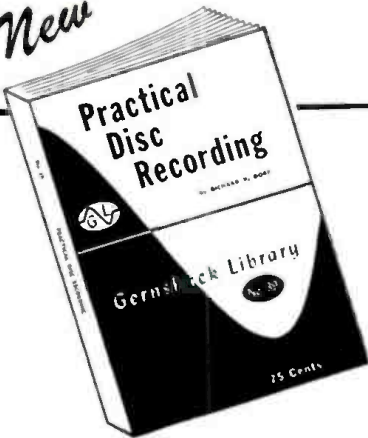

PRACTICAL DISC RECORDING

Answers Your Questions

PRACTICAL INFORMATION

Here is the book that thousands of radio enthusiasts have been waiting for. Whether you're interested in amateur or professional recording, you'll find PRACTICAL DISC RECORDING by Richard H. Dorf invaluable. It not only tells you how to make successful records, but in addition each important recording component is given a full chapter, explaining its purpose, and what features to look for when buying. You'll like this book for many reasons. Without waste of words, it gets right down to business on the first page. It tells you what you need to make good records and how to do it by using any type equipment—from the simplest to the most expensive—depending on your purpose and pocketbook. You will find all the practical phases of recording covered as well as the underlying principles.

FILLED WITH FACTS

Chapter 1 discusses the various components which make up the complete system. Chapters 2 to 5 go into the practical details of the selection and use of discs, motors and turntables, feed mechanisms and cutters. Chapter 6 is a comprehensive explanation of constant amplitude and constant velocity recording, the two fundamental recording characteristics on which all recording is based. Chapter 7 covers stylus selection. In Chapter 8 the various sound sources (microphones, radio tuners, etc.) are discussed. A feature is the handy chart of characteristics of different types of microphones. Chapter 9 discusses the all-important amplifier. Circuits of several practical amplifiers are given. In Chapters 10 thru 13, you'll find explained the detailed techniques of making good records. All the fine points of adjustment, equalization, microphone placement and microphone technique, and a whole chapter on dubbing. Chapter 14 is a concise summary of common troubles in recording, and how to overcome them. The book ends with a comprehensive glossary of recording terms.

96 PAGES, 82 ILLUSTRATIONS

Only 75c

See your radio parts jobber today or order direct.

SEE COUPON BELOW

CLIP AND MAIL

RADCRAFT PUBLICATIONS, INC.,
Dept. 12-8
25 West Broadway, New York 7, N. Y.

Send me PRACTICAL DISC RECORDING
I enclose 75c.

Your Name
(Print clearly)

Address

Jobber's Name

Address

ALUMINUM DISCS

Every recordist uses some blank discs for making test cuts. Instead of throwing these away after they are used, immerse them in hot water for several minutes, then peel off the recording lacquer. The shiny aluminum disc that emerges will be useful for making small chassis, shields, and separators. The lady of the house will find them useful, too, for serving canapes or for use as coasters for plants and flower-pots.

JOHN ANTHONY TAGLIABUE,
Union City, N. J.

PILOT LAMP FUSE

A shorted first filter condenser in a receiver power supply usually causes the rectifier tube to burn out, necessitating an expensive replacement. To prevent this, I place a pilot lamp in series with the rectifier cathode and the input to the filter.

In normal operation, the lamp will make a very good pilot. If the first filter (or any later component which is across the power supply) shorts, the excessive current drawn by the lamp will burn it out. It thus acts as a fuse, protecting the rectifier tube.

The lamp chosen should be a 6-volt one, with a current rating somewhat higher than the total current drawn by the receiver and filter (as determined with an ammeter placed temporarily where the lamp will go).

JEAN S. BASTIN,
Rouvé, Belgium

SPEAKER REPLACEMENT

The cone of the electrodynamic speaker in my table-model receiver was damaged beyond repair, and I wanted to use a PM speaker as the replacement.

I removed the field coil (with its core and housing) and output transformer from the old speaker, leaving all leads connected, and fastened the field coil under the chassis with solder.

The new PM was installed, and the old output transformer mounted on it. I connected the new voice coil to the proper transformer terminals.

This avoided the necessity for procuring a new electrodynamic speaker, since the old field coil is still in the circuit, acting as a power-supply choke, just as it did before.

JOHN R. HOOPER,
Eastport, Me.

TRANSFORMER WINDING

When winding a transformer with small wire, it is usually quite a problem to keep the windings in place during the winding process. Masking tape will solve the problem. The tape is wrapped around the form, gummy side up, and each turn sticks to the tape.

Masking tape is also useful where the person winding the coil wants to stop in the middle of the job for any reason. The wire already wound will remain in place until the work is resumed.

JOHN E. KENT,
Waynesboro, Va.

A Remarkable NEW LINE

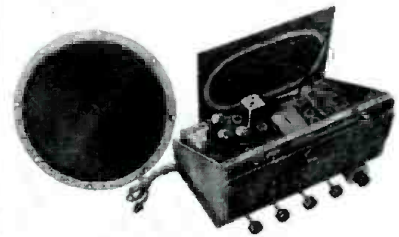

Espey Model 511

High QUALITY
High POWER

Custom-Built

AM-FM Chassis

Like every other model in the complete ESPEY line of replacement receivers, and FM Tuners, the Model 511 AM-FM chassis (illustrated) is the last word in modern engineering in the electronics field. Featuring 12 tubes plus Rectifier and Tuning Indicator, it is Drift Compensated, and is supplied complete with all antennas, 25 watt speaker, and all hardware. Its low price assures high profits for you in the growing replacement field. Write today to Dept. C-11 for complete details of this expanding profitable market!

ESPEY MFG. CO., Inc.

528 East 72nd Street
New York 21, N. Y.

"Established—1928"

BRAND NEW SURPLUS! GUARANTEED!

3/4 RPM, HI-TORQUE
ELECTRIC MOTOR



\$2.85

Plus
40c
Postage
and
Handling

- Operates on 110V AC, 60-cycles.
- (Requires only 12 MFD condenser.)
- Reversible. No Free Swings. Quiet.
- With Full Instructions.
- FOR ROTATING HAM, FM, TELEVISION ANTENNAS AND MANY OTHER USES.

BARGAIN RADIO, Dept. BR-2
249 N. Juanita Los Angeles 4, California

SEE the TELEVISION ASSEMBLY CO. SPECIAL SECTION IN NEXT MONTH'S ISSUE

TECHNICAL KO's

OIL-FILLED CONDENSERS		TRANSMITTING MICAS	
.05 MFD 1000V	\$0.35	.00005 2500V	\$0.15
.05 500V	.14	.00005 3000V	.35
1 2500V	.75	.00005 5000V	.85
1 7500V	1.65	.000067 2500V	.20
2x 1 7000V	4.10	.00007 2500V	.20
.12 15000V	7.95	.00025 2500V	.25
.25 1000V	.35	.00025 5000V	.85
.25 1000V	2.15	.0005 2500V	.25
.25 6000V	3.75	.0005 5000V	.85
10x 25 600V	1.05	.0008 5000V	.85
.5 600V	.28	.001 2500V	.25
.5 1000V	.40	.001 5000V	.85
.5 2000V	.75	.002 1200V	.20
.75 100V	.30	.002 3000V	.30
.85 600V	.35	.003 2500V	.30
1.0 1000V	.45	.003 3000V	.65
2.0 200V	.20	.004 2500V	.35
2.0 600V	.40	.005 1000V	.15
2.0 1000V	.60	.005 3000V	.65
1.0 100V	.60	.006 2000V	.35
1.0 1000V	1.00	.008 1200V	.15
5.0 220VAC	.55	.01 1200V	.15
8.0 1000V	1.45		
8.0 600V	.85		
8.0 1000V	1.75		
30.0 600V	1.00		
30.0 300VAC	1.40		
30.0 330VAC	3.75		

TUBES-CHOKE-POTS	
Tubes 12K8 Metal	.29
Choke-100MA InH.	1.59
250 Ohm	1.59
Pots: 20K 50K 100K	.19
Dual 1/2 Meg	.30
Dual 50K 50K	.30

25.0 Electrolytic 25V	.40
25V	.50

SHIELDED WIRE #2250 Ft. for	.65
RESISTOR KIT Assorted 1/2&1W 100 for	1.19
BATHTUB KIT 3x1, .5, .05, ETC. 10 for	.58
CONDENSER KIT .01-.00001100 for	2.99
MICAS .01, .002, .005, ETC. All Values	.08
.01 150V PAPER (MIDGET)60 for	1.00
0.1 600V PAPER8 for	1.00

\$2.00 min. order F.O.B., N.Y.C. Add postage 50% deposit, balance C.O.D. with all orders. Manufacturers inquiries invited. Send for Flyer. Prices are subject to change without notice.

TECHNICAL RADIO PARTS CO.
 MOVED TO LARGER QUARTERS
 557 McDonald Ave., Brooklyn 18, N. Y.
 Dept. RE-7

HARD-TO-GET PARTS

POWERFUL ALL-PURPOSE INDUCTION MOTOR



IDEAL FOR EXPERIMENTERS—101 USES

Sturdily constructed to precision standards, this self-starting shaded-pole A.C. induction motor is powerful enough for a number of uses. Some of these are: Automatic Timing Devices, Current Interrupters, Electric Fans, Electric Chimes, Window Displays, PhotoCell Control Devices, Electric Vibrators, Small Grinders, Buffers and Polishers, Miniature Pumps, Mechanical Modifications, Sirens, and other applications.

Consumes about 15 watts of power and has a speed of 3,000 r.p.m. When geared down, this sturdy unit will constantly operate an 18-inch turntable loaded with 200 lbs. dead weight—THAT'S POWER!

Dimensions 3" high by 2" wide by 1 1/2" deep; has 4 convenient mounting studs; shaft is 3/16" long by 3/16" diameter, and runs in self-aligning oil-retaining bearings. Designed for 110-220 volts, 50-60 cycles, A.C. only. Shp. Wt. 2 lbs.

ITEM NO. 147
 YOUR PRICE \$2.95

ULTRA MAGNET

LIFTS MORE THAN 20 TIMES ITS OWN WEIGHT

LITTLE GIANT MAGNET

Lifts 5 lbs. easily. Weighs 4 oz. Made of ALNICO new high-magnetic steel. Complete with keeper. World's most powerful magnet magnet. The experimenter and hobbyist will find hundreds of excellent uses for this high quality permanent magnet. Measures 1 3/4" x 1 1/2" Shp. Wt. 34 lbs.

ITEM NO. 159
 YOUR PRICE \$1.50



GENUINE MICROPHONE TRANSMITTERS



Regular telephone transmitters taken from a large telephone supply company's overstock. Work perfectly on 2 dry cells. Can be used on P.A. systems, call systems, intercommunications, etc. Also, short-line telephone circuits, house-to-house or farm-to-farm 'phone lines, also to talk through your own radio or as concealed telephone replacements on battery-operated rural telephone lines.

THESE ARE GENUINE ELECTRIC AND STROMBERG-CARLSON, excellent in appearance and operation. A remarkable value and one seldom offered in these times. Shp. Wt. 1 lb.

ITEM No. 160
 YOUR PRICE \$1.95

WATTHOUR METER



Completely overhauled and ready for immediate service. Designed for receiver 110-volt, 60 cycle 2-wire A.C. circuit. Simple to install—2 wires from the line and 2 wires to the load. Sturdily constructed in heavy metal case, 6 1/2" high, 4 1/2" wide, 5" deep. Westinghouse, G. E., Ft. Wayne, Sylvania or other available make Shp. Wt. 14 lbs.

ITEM NO. 33
 YOUR PRICE \$6.50

AMAZING BLACK LIGHT!



Powerful 250 Watt Ultra-Violet Source!

The best and most practical source of ultra-violet light for general experimental and entertainment use. Makes all fluorescent substances brilliantly luminescent. No transformers of any kind needed. Fits any standard lamp socket. Brings out beautiful phosphorescent hues in various types of materials. Swell for amateur parties, plays, etc.; to obtain unique lighting effects. Sub only. Shp. Wt.

ITEM NO. 87
 YOUR PRICE \$2.50

WESTERN ELECTRIC BREAST MIKE



This is a fine light-weight aircraft carbon microphone. It weighs only 1 lb.

Mike comes with breastplate mounting and has 2-way swiveling adjustment so that it can be adjusted to any desired position. There are 2 woven straps; one goes around neck, the other around chest. Straps can be snapped on and off quickly by an ingenious arrangement.

This excellent mike can be adapted for home broadcasting or private communications systems. By dismounting breastplate, it can be used as desk mike.

Comes complete with 6-foot cord and hard rubber plug. Finished in sacardized metal, non-rustable. Shipping weight, 2 lbs.

ITEM 152
 YOUR PRICE \$1.49

HUDSON SPECIALTIES CO.
 40 West Broadway, Dept. RE-12-48, New York 7, N.Y.

I have circled below the numbers of the items I'm ordering. My full remittance of \$ (NO C.O.D. ORDERS UNLESS ACCOMPANIED WITH A DEPOSIT.) Or my deposit of \$ is enclosed (20% required), ship order C.O.D. for balance. NO C.O.D. ORDER FOR LESS THAN \$5.00. BE SURE TO INCLUDE SHIPPING CHARGES. Circle Item No. wanted:

147 159 160 87 152 33

Name

Address Please Print Clearly

City State

"NEW LOOK" COMMENTS

Dear Editor:

We really enjoy your new format and the more frequent television articles. Glad to see that your gang is waking up to the fact that television will be the giant of the electronics field in short order.

STAR RADIO,
 Perth Amboy, N. J.

Dear Editor:

I am really glad it is now possible to read RADIO-ELECTRONICS without turning pages to hunt for the continuation of the article.

FELIX HUTTRER,
 Plymouth, England

Dear Editor:

Congratulations on the new RADIO-ELECTRONICS! It's a beauty, from front index and color right down to the slick-paper noncontinuation articles.

DAVID GNESSIN,
 Columbus, Ohio

Dear Editor:

Congratulations on the new setup for RADIO-ELECTRONICS. My chief interest is that it keep its technical excellence, but I particularly welcome the departmentalization. I also like the color emphasis, as in "Eclipse of the Vacuum Tube" (September issue). There is never a dull moment with RADIO-ELECTRONICS!

H. F. LESLIE,
 Somerset, England

FM NOISE NO PROBLEM

Dear Editor:

In your August issue you printed a letter concerning ignition noise in FM receivers. I think the writer was using a poor receiver. I base this on my personal experience with a Zenith model 7H822 which is on my desk. I am on the second floor, on the street side of the building, and there is a continuous procession of automobiles and trucks going by all day long. I have yet to hear any ignition noise when the set is tuned to a station.

I think Mr. Zarattaro was using a receiver with poor noise-reducing properties or one that was defective, as my location is certainly a severe one.

K. E. HASSEL,
 Assistant Vice President,
 Zenith Radio Corp.

FAVORS RATIO DETECTOR

Dear Editor:

In the letter which pointed out that ignition often ruins FM radio reception, Mr. Zarattaro is quite correct.

However, the problem may be solved very easily by converting the discriminator to a ratio detector or by adding a limiter stage to the existing ratio detector.

I have a Meissner FM tuner which gives me very good reception.

THOMAS W. ATHALEY,
 New Bedford, Mass.

TUNE FM SETS CORRECTLY

Dear Editor:

I think part of Mr. Zarattaro's trouble is in not having the station tuned in properly. If I don't have my FM receiver tuned right, automobile interference will break through; but correctly retuning the set cuts out interference. I am located right on a main highway where there is plenty of traffic.

I listen for the between-station hiss when I tune my set. When the hiss is gone, I figure the station is tuned in properly. I tune in a station, not for the loudest, but for the clearest sound.

FRANK C. PIERCE,
New Bedford, Mass.

(Perfect discriminator alignment, as well as perfect tuning, is necessary for exclusion of interference. This may explain some of the apparently contradictory results obtained by readers with similar equipment and in similar situations.—Editor)

WANTS CODE-STATION LIST

Dear Editor:

The September issue of RADIO-CRAFT wins our approval for design and editorial content. We have been reading your magazines since the days of *Modern Electrics*. Many things have happened in radio since the time the *Electrical Experimenter* and Duck's catalogue, but without Gernsback's leadership and foresight many of us old-timers (I have been in radio and electricity since 1908) in all probability would have been lost in the confusion.

I still copy code and would like to see a table of call letters of low-frequency commercial stations published in the magazine. What say?

HOWARD'S RADIO HOSPITAL,
Cleveland, Ohio.

(Any other readers interested in a list of commercial c.w. stations for code-practice purposes?—Editor)

FM SERVICE INADEQUATE

Dear Editor:

As a long-time FM listener, I am certainly disappointed in the type of service FM is giving. Too many stations in this area are giving forth with low fidelity, operating with low interim power, or making no attempt to get on the air at all. As for high fidelity, only two stations out of about 25 I can receive even approach the 15,000-cycle standard.

FM receivers, too, lack high standards. I have tried many; most lack sensitivity and drift too much.

At present I am using a Meissner AM-FM tuner and a Hallicrafters SX-42. The antenna is a rotatable Vee-Dx on a 20-foot mast on the roof. Best dx I have gotten was about 250 miles. I find that dx is best from 10 pm on when the sky is overcast and the humidity low.

I prefer having FM stations listed by frequency instead of by call letters.

THOMAS A. IREY,
Boyetown, Pa.

\$1,000 A MONTH



That's what JUST ONE of the many plans in this book brought in—over \$1,000 a month, steadily, from radio service alone. HOW TO MAKE MORE MONEY IN RADIO SERVICE is so full of money-making plans and ideas it will amaze you. Why work for wages? Why not become your own boss and make more money? EVEN BEGINNERS who used some of the easier plans in this book averaged WAY OVER \$100 A WEEK just working from home. This book is making money for servicemen and beginners, everywhere—U.S.A., Canada,

Puerto Rico, Mexico, So. America, Hawaii, Philippines, and other countries. Letters of thanks are continually coming in.

AT LAST!

The real money-making secrets of radio service are given out in this book.

—Book very helpful—following advice in the book earned him a \$100 a week radio repairing in my apartment.
C. C. Seidler, Brooklyn, N. Y.

—In business 10 years—received many valuable pointers—read it 3 times. Would not take twice the price for it.
W. J. Phillips, Burlington, W. Va.

—In radio 15 years—Book contains far more information than expected.—Every radio man should have this book.
W. J. Fraser, Elmout, N. Y.

—Best of its kind that have ever been printed.
W. Bradford, E. Chicago, Indiana

Have book only a week—couldn't stop reading it. Already made money and many new customers.
A. T. Waters, Jr., Carthage, N. Y.

In business 17 years. Book contains many things which took me many years to learn the hard way. Book worth many times its small cost.
P. V. Furrner, Elmwood, Illinois

25 years experience are packed in this 83 page book, 8 1/2 x 10 3/4, by V. Gale, for servicemen, beginners, students. Among MANY OTHER THINGS it shows you where the money is and how to get it FAST; How to get plenty of customers; How to test sets without taking them out of cabinets and give estimates QUICKLY; How to operate spare time and build to full time; How much to charge; How to connect with certain BIG MONEY concerns; How to increase business and expand. Send for this book today and start making more money almost as soon as you get it. The full price is only \$3 (any convenient form) postpaid; or C.O.D. at \$3 plus a few cents postal charges. You have nothing to lose. Examine it for 5 days. If you aren't positively delighted return it and we will refund you \$3 promptly. If you want more information about the book send for literature #2-RE. It's free.

MERIT PRODUCTS, DEPT. RE,

216-32 132 Avenue. Springfield Gardens 13, N. Y.

free



For EVERYONE interested in
TELEVISION • RADIO • ELECTRONICS
SOUND SYSTEMS • INDUSTRIAL EQUIPMENT
EVERYTHING in standard brand equipment!

Professional! Radio Home! Television Enthusiasts! Beginners! Oldtimers! Amateurs! Hobbyists! Here's one book that's a MUST for you! Our FREE 148 page catalog jammed with over 20,000 different items. The smallest part to the most complete industrial system from one dependable source!

24-HR. MAIL ORDER SERVICE • ONE YEAR TO PAY

3 GREAT STORES: Uptown at 115 West 45th St. and Downtown at 212 Fulton St. in NEW YORK 323 W. Madison St. in the heart of CHICAGO

MAIL ORDER DIVISIONS: 242 W. 55th St., N. Y. 19 and 323 West Madison St., Chicago 6, Illinois



MAIL COUPON NOW
Newark Electric Co., Dept. L11, 242 W. 55th St., New York 19, N. Y.

Please send me FREE the Newark 1949 Catalog
NAME _____
ADDRESS _____ CITY _____ STATE _____

Remember!

In next month's issue there will be a

SPECIAL SECTION

on

TELEVISION ASSEMBLY CO.

140 BUSHWICK AVE BROOKLYN 4 N. Y.

Christmas Values

From Mort's Radio Shack
NEW HF 10 TRUSOUND AMPLIFIER

A general purpose unit of small size (6" x 9" x 7") for high quality reproduction of sound, music and speech from records, radio, microphone. Engineered and built to meet the high quality standards required of an amplifier when used in conjunction with the new high fidelity pickups. FM-AM tuners and wide range speaker systems. NOTE THESE FEATURES:
★ 10 Watts undistorted power output 18 watts peak.
★ Inputs: High gain for variable reluctance pickups; for high impedance mikes. Low gain for FM-AM tuners and high output pickups.
★ Selector switch for rapid changeover.
★ Hum level 70 db below 12 watts.
★ Tone compensation. Separate continuously variable base and treble controls.
★ Treble—from 10 db to minus 15 db at 10,000 cps.
★ Bass—from plus 10 db to minus 15 db at 50 cps.
★ Note—flat characteristics obtained with controls centered.
★ Output impedance 2, 4, 8, 16 and 500 ohms.
★ Straight AC for 110-120V 50-60 cycles fused.
★ Tubes—6X4, 6X6, 6X7, 2-6V6, 5
★ Chassis and shield silver grey hammerloid finish.
★ Hermetically sealed components used throughout.
Complete with Tubes and Cover **\$29.95**



CHRISTMAS TREE LIGHTS

2 MULTIPLE SETS

115—13 lights Multiple set with assorted colored C7 1/2 lamps. Each lamp burns independently. Lamp's not lit are immediately located. Add on plug at end of festoon for attaching additional sets.
List Price, \$6.20 set
Your cost, \$4.98 set

177—7 light Multiple set with C7 1/2-120V lamps in 5 assorted colors. Each light burns independently. Lamp's not lit are immediately located. Add on plug at end of festoon for attaching additional sets.
List Price, \$3.20 set
Your Cost, \$2.62 set

MICRO GROOVE PHONO PLAYER

A NEW Trusound Micro Groove Record Player. Proven in hundreds of broadcasting stations in the U. S. The Trusound Micro Groove Record Player uses the new SHURE Featherweight arm and cartridge. Overall wt. 8 grams. Prolongs life of the fine micro-groove recordings. The 33 1/3 RPM constant speed motor is smooth and quiet with no VIBES or rumbles to interfere with your listening pleasure.
List Price, \$24.95
Your Cost in lots of 1-3, \$16.50 ea.
4 or More, \$13.95 ea.

Mort's Radio Shack

Dept. RE-12
630 W. Randolph St., Chicago 6, Illinois

RADIO SCHOOL DIRECTORY

Become a Radio and



IN 18 MONTHS!

Here is the opportunity you have been waiting for. Now you can get in on the ground floor of the nation's fastest growing industry—TELEVISION.

LOOK AT THIS RECORD — In 1946 only 6,500 television sets were manufactured — in 1947 this skyrocketed to 175,000 — already in the first four months of 1948 over 160,000 sets have been produced. This means hundreds of new jobs are being created every month.

MSOE NOW ADDS TELEVISION — The Milwaukee School of Engineering now provides complete, practical, technical training in television as well as Radio in its laboratories. This is not just a *serviceman's* course. The special 18 month's residence course includes complete training in radio as well as television — qualifies you for a successful career as a technician in all phases, AM, FM, TV Receivers and Transmitters and Radio Communications.

This Technician Course Prepares You For Any Of These Jobs:

- | | |
|-----------------------------|----------------------------------|
| Radio Servicing — AM and FM | Police, Taxicab and Railroad |
| TV receiver servicing | transmitters operating |
| Broadcast Station Operating | and receiver servicing |
| Electronic Parts Sales | Supervising and testing in radio |
| Radio and TV sales | and TV manufacturing |
| Radio and TV manufacturing | Shop managing |



Electrical Engineering
Bachelor of Science Degree
in 2 additional years
Majoring in **ELECTRONICS**

MILWAUKEE SCHOOL OF ENGINEERING
"A Technical Institute • Founded 1903"
Dept. RE-1248 N. Broadway, Milwaukee, Wis.

COURSES

SERVICE

- 6 to 12 Months
- Practical Electricity
- Welding
- Refrigeration
- Heating

TECHNICIAN

- 12 to 24 Months
- Electrotechnics
- Radio and Television
- Electronics
- Refrigeration, Heating and Air Conditioning

PROFESSIONAL

- 36 Months
- Electrical Engineering
- Bachelor of Science Degree
- Major in Machinery or Electronics

Terms start January, April, July.

MILWAUKEE SCHOOL OF ENGINEERING,
N. Broadway and E. State, Milwaukee, Wis.
Without obligation send me free booklet "Career Building" and more details on course in Radio and Television or Course.
Name.....Age.....
Address.....
City.....State.....(RE-1248)

WANTED:

Men and Women to Fill TOP RADIO JOBS in AM—FM—Television

If you are looking for a career with a future, why not join the hundreds of Graduates from the Don Martin School of Radio Arts now successfully employed in the radio industry. The demand is great for qualified radio personnel in AM-FM-Television. Train now to be an announcer, script writer, disk jockey, newscaster, or radio technician. Complete day and night classes . . . the latest equipment. Free placement service. Approved for veterans. Write for free booklet.

Don Martin School of Radio Arts

1655 North Cherokee St. Hollywood 28, Calif.



RADIO COURSES

Preparatory, Service, Broadcast, Television, Marine Operating, Aeronautical, Frequency Modulation, Radar.

Classes now forming for mid-year term Feb. 1st
Entrance exam. Jan. 17
Veterans. Literature.

COMMERCIAL RADIO INSTITUTE
(Founded 1920)
39 West Biddle Street, Baltimore 1, Md.



RADIO and TELEVISION

Thorough Training in All Technical Phases
APPROVED FOR VETERANS
DAYS—EVENINGS WEEKLY WATER

RCA GRADUATES ARE IN DEMAND
For Free Catalog Write Dept. RC-48

RCA INSTITUTES, Inc.
A Service of Radio Corporation of America
350 WEST 4TH STREET NEW YORK 14, N. Y.

TELEVISION 1948!!

Train at an Institute that pioneered in TELEVISION TRAINING since 1938. Morning, Afternoon or Evening Sessions in laboratory and theoretical instruction, under guidance of experts, covering all phases of Radio, Frequency Modulation, Television, lead to opportunities in Industry, Broadcasting or own Business. Licensed by N. Y. State. Approved for Veterans.

ENROLL NOW FOR NEW CLASSES
Visit, Write or Phone

RADIO-TELEVISION INSTITUTE

480 Lexington Ave., N. Y. 17 (46th St.)
Plaza 3-4585 2 blocks from Grand Central

LEARN RADIO!

IN ONLY 10 MONTHS
PREPARE FOR A GOOD JOB!
COMMERCIAL OPERATOR (CODE)
BROADCAST ENGINEER
RADIO SERVICEMAN

Television Servicing—15 Months

Veterans get \$130.00 Equipment
SEND FOR FREE LITERATURE

BALTIMORE TECHNICAL INSTITUTE
1425 Eutaw Place, Dept. C, Baltimore 17, Md.

CORRESPONDENCE COURSES IN RADIO and ELECTRICAL ENGINEERING

ELECTRICAL ENGINEERING U.S. 8000
Prepare yourself at Low Cost, for secure future. Mover's course. So simplified anyone can understand quickly.

RADIO ENGINEERING U.S. 8000
One course in radio. public address, photo-electric work. Trains you to be super-serviceman, real vacuum-tube technician. Servicemen needed badly. Diploma on completion. Many graduate earning big pay.

Send postcard for Free Copies of school catalog, full details, all about deferred payment plan, ex-
WRITE **\$25** Either experimental kits, etc.
Lincoln Engineering School, Box 931-C-118, Lincoln 2, Neb.

RADIO COURSES

- RADIO OPERATING
- RADIO SERVICING
- CODE
- ELECTRONICS
- F.M. TELEVISION
- REFRIGERATION SERVICING

Write for Catalog and Picture Brochure

Y.M.C.A. TRADE & TECHNICAL SCHOOLS
15 W. 63rd St. (N.Y. B'way) New York City



CODE SENDING SPEED

Be a "key" man. Learn how to send and receive messages in code by telegraph and radio. Commerce needs thousands of men for jobs. Good pay, adventure, interesting work. Learn at home quickly through famous Candler System. Qualify for Amateur or Commercial License. Write for FREE BOOK.

CANDLER SYSTEM CO.
Dept. 3-0, Box 928, Denver 1, Colo., U.S.A.

RADIO

TECHNICIAN and RADIO SERVICE COURSES
FM and TELEVISION

AMERICAN RADIO INSTITUTE
101 West 63rd St., New York 23, New York
Approved Under GI Bill of Rights
Licensed by New York State

RADIO ENGINEERING!

Complete Radio Engineering Course. Bachelor of Science Degree. Courses also in Civil, Electrical, Mechanical, Chemical, Aeronautical Engineering; Business Administration, Accounting, Secretarial Science. Graduates successful. 65th year. Enter Jan., March, June, Sept. Write for catalog.

TRI-STATE COLLEGE 24128 College Ave. ANGOLA INDIANA

SOUND RECORDING SCHOOL

A practical engineering course in Sound Fundamentals, Recording, and Sound Transmission measurements; in a laboratory containing transmission sets, oscillators, square wave generator and intermodulation analyzer, and other equipment.

Complete recording studio assimilating broadcast, motion picture and commercial sound recording, under the direction of H. M. Trenaine.

HOLLYWOOD SOUND INSTITUTE, Inc.
1040-C No. Kenmore Hollywood 27, Calif.

6N6-G IS AVAILABLE

Dear Editor:

On page 58 of your August, 1948, issue, we note a squib on substituting the 6K6 for the 6N6. The statement is made that the 6N6 is "no longer available."

You may be interested to know that Hytron is manufacturing the 6N6-G for the industry — and has for several months been supplying the tube through its Hytron jobbers.

HARRY G. BURNETT,
Hytron Radio and
Electronics Corp.
Salem, Mass.

(Fine! When are we going to hear about renewed production of the 6A5-G? There has been a tremendous popular demand for that tube during the past year.—Editor)

STATEMENT OF THE OWNERSHIP, MANAGEMENT, CIRCULATION, ETC., REQUIRED BY THE ACT OF CONGRESS OF AUGUST 24, 1912, AS AMENDED BY THE ACTS OF MARCH 3, 1933, AND JULY 2, 1946

Of Radio-Electronics, published monthly at Philadelphia, Pa. for October 1st, 1948.
State of New York } ss.
County of New York }

Before me, a Notary Public in and for the State and county aforesaid, personally appeared Hugo Gernsback, who, having been duly sworn according to law, deposes and says that he is the editor of the Radio-Electronics, and that the following is, to the best of his knowledge and belief, a true statement of the ownership, management (and if a daily, weekly, semiweekly or triweekly newspaper, the circulation), etc., of the aforesaid publication for the date shown in the above caption, required by the act of August 24, 1912, as amended by the acts of March 3, 1933, and July 2, 1946 (section 537, Postal Laws and Regulations), printed on the reverse of this form, to wit:

1. That the names and addresses of the publisher, editor, managing editor, and business managers are: Publisher, Radcraft Publications, Inc., 25 West Broadway, New York 7, N. Y.; Editor, Hugo Gernsback, 25 West Broadway, New York 7, N. Y.; Managing Editor, Fred Shunaman, 25 West Broadway, New York 7, N. Y.; Business Manager, none.

2. That the owner is: (If owned by a corporation, its name and address must be stated and also immediately thereunder the names and addresses of stockholders owning or holding one percent or more of total amount of stock. If not owned by a corporation, the names and addresses of the individual owners must be given. If owned by a firm, company, or other unincorporated concern, its name and address, as well as those of each individual member, must be given.) Radcraft Publications, Inc., 25 West Broadway, New York 7, N. Y.; H. Gernsback, 25 West Broadway, New York 7, N. Y.

3. That the known bondholders, mortgagees, and other security holders owning or holding 1 percent or more of total amount of bonds, mortgages, or other securities are: (If there are none, so state.) None.

4. That the two paragraphs next above, giving the names of the owners, stockholders, and security holders, if any, contain not only the list of stockholders and security holders as they appear upon the books of the company but also, in cases where the stockholder or security holder appears upon the books of the company as trustee or in any other fiduciary relation, the name of the person or corporation for whom such trustee is acting, is given; also that the said two paragraphs contain statements embracing affiant's full knowledge and belief as to the circumstances and conditions under which stockholders and security holders who do not appear upon the books of the company as trustees, hold stock and securities in a capacity other than that of a bona fide owner; and this affiant has no reason to believe that any other person, association, or corporation has any interest direct or indirect in the said stock, bonds, or other securities than as so stated by him.

5. That the average number of copies of each issue of this publication sold or distributed through the mails or otherwise, to paid subscribers during the twelve months preceding the date shown above is
(This information is required from daily, weekly, semiweekly, and triweekly newspapers only.)
(Signature of editor, publisher, business manager, or owner) H. Gernsback.

Sworn to and subscribed before me this 1st day of October, 1948. May Parisi, Notary Public.
[Seal]

(My commission expires, March 30, 1949)

DECEMBER, 1948

**SOUND EQUIPMENT,
SOUND VALUES
IN RADIONIC'S
FREE CATALOG**

SENSATIONAL TUBE OFFER!

TUBES

Made by famous manufacturer. Brand new tubes! No surplus! Every tube individually tested and carries standard RMA guarantee. Your money back if any tube fails to give complete satisfaction.

1R5	6SK7GT	12SQ7CT
1S5	6SQ7GT	35L6GT
17A	6V6GT	35W4
15A	6X5GT	35Z5GT
6AT6	12AT6	50B5
6BE6	12BE6	50L6GT
6HE6	12BE6	6SA7GT
6K5GT	12SA7GT	36c
6HGCT	12S7GT	
6SJ7GT	6SK7GT	each

CONDENSERS

Brand New Stock (No Government Surplus)	
FAMOUS MAKE	
ELECTROLYTIC (Tubular)	
25	mfd @ 25v 30c
20/20	mfd @ 150v 45c
50/30	mfd @ 150v 55c
8	mfd @ 450v 35c
12	mfd @ 450v 40c
16	mfd @ 450v 50c
20	mfd @ 450v 55c
PAPER (Tubular)	
.1	mfd @ 600v 15c
.05	mfd @ 600v 13c
.01	mfd @ 600v 12c
.005	mfd @ 600v 9c

STORE OPEN DAILY 9 to 6—SATURDAY 9 to 5
Minimum order \$3.00. 20% deposit. Bal. C.O.D.

RADIONIC EQUIPMENT COMPANY
170 MASSAU ST., NEW YORK 7, N.Y.

Tribune Theatre Entrance
Tel. WOrk 2-0421 • Cable "CHANSLOR"

RADIONIC EQUIPMENT CO., Dept. 1012

170 Nassau Street, New York 7, N. Y.

Send at once your free catalogs, supplements and bargain lists as published—listing products of leading manufacturers of radio-electronic parts and equipment.

NAME

P.O. BOX or STREET

TOWN STATE

Get Started in Radio

10 "HOW-TO-DO-IT" BOOKS



Get a solid foundation in radio by means of these 10c timely text books. Each clearly written, profusely illustrated, contains over 15,000 words. You'll be amazed at the wealth of information packed into these handy books. Excellent for reference—ideal for technical library. Your money back if not satisfied.

5 BOOKS for 50c
10 BOOKS for \$1.00
Sent to You Postpaid

- | | |
|--|-------------------------------------|
| No. 1—How To Make Four Dierie Short Wave Sets | No. 6—How To Have Fun With Radio |
| No. 2—How To Make The Most Popular All-Wave 1 and 2 Tube Receivers | No. 7—How To Read Radio Diagrams |
| No. 3—Alternating Current for Beginners | No. 8—Radio for Beginners |
| No. 4—All About Aerials | No. 9—Simple Electrical Experiments |
| No. 5—Beginners' Radio Dic. | No. 10—Television |

Remit by check or money order—register letter if you send cash or stamps.

RADIO PUBLICATIONS

25A West B'way. New York (7)

FCC LICENSE TRAINING

Successful radio operators are skilled technicians—able to troubleshoot and repair sudden equipment breakdowns. WRCI SPECIALIZED TRAINING provides the essential practical experience and theoretical knowledge. Before selecting a technical school investigate how thorough its training is. Investigate WRCI SPECIALIZED TRAINING methods—and compare. Send for Bulletin "Y". Approved for Veterans.
Western Radio Communications Institute
341 West Eighteenth St., Los Angeles 15, Calif.

Make Good in RADIO-TELEVISION at Home

Hollywood Experts Help You
Direct from Hollywood, nerve-center of broadcasting, television, radio and sound activities, comes R-T-A's time-proven and tested home training. Here at last—easy to learn, home instruction that quickly qualifies you for steady, good-pay jobs or your own radio business. 10 big kits of radio parts given at no extra charge. Get full details at once! Send postal for FREE BOOK "How to Make Good in Radio-Television."

RADIO TRAINING ASS'N OF AMERICA, Dept. RL
8620 Hollywood Blvd. Hollywood 28, Calif.

Are YOU Fixing Radios this New, EASY Way?



REMARKABLE NEW FEILER "STETHOSCOPE" Method Guaranteed to Lick Toughest Jobs!

SENSATIONAL—NEW! FM & TELEVISION CATHODE-RAY STETHOSCOPE only \$89.95. Get manual for full details.

Why let old-fashioned servicing methods and equipment hamper your servicing ability? Thousands of radio servicemen—many with little experience—are already fixing radios this remarkable "automatic" way. It's as simple as A.B.C. because Stethoscope Servicing is the newest, most basic method yet devised to simplify all repairs. Stethoscope Servicing is guaranteed to speed-up and improve your servicing ability or your money will be refunded. You owe it to yourself to find out how you, too, can begin cashing in. Stethoscopes come in a wide variety of prices from \$9.85 to \$89.95. There's a Stethoscope to meet every need. Don't delay—send coupon today.

perence—are already fixing radios this remarkable "automatic" way. It's as simple as A.B.C. because Stethoscope Servicing is the newest, most basic method yet devised to simplify all repairs. Stethoscope Servicing is guaranteed to speed-up and improve your servicing ability or your money will be refunded. You owe it to yourself to find out how you, too, can begin cashing in. Stethoscopes come in a wide variety of prices from \$9.85 to \$89.95. There's a Stethoscope to meet every need. Don't delay—send coupon today.

New Technical Manual FREE!

"The Inside Story" contains valuable hints and tips. This new complete illustrated 28-page technical manual tells the inside story of an amazing new servicing method—also contains many valuable hints and links for every radio serviceman. Send 3c stamp to cover handling only—manual FREE.



DON'T DELAY—MAIL COUPON NOW!

FEILER ENGINEERING CO., Dept. 12RE8
945 George St., Chicago 14, Ill.
Please rush FREE manual "The Inside Story". I enclose stamp to cover handling only.

Name

Address

City State

WHICH MAGNETIC TAPE RECORDER
DOUBLES YOUR PLAYING TIME.. CUTS YOUR TAPE COSTS IN HALF?

Write today for technical literature.
AMPLIFIER CORP. OF AMERICA
398-10 Broadway New York 13, N.Y.

WE ARE LOOKING FOR TUBES!

WHAT HAVE YOU GOT?
Interested in small or large quantities of all types of Transmitting, Industrial, and Receiving Tubes. Send offerings to:
T. L. BLACK, WHOLESALE TUBE DIV.
NIAGARA RADIO SUPPLY CORP.
160 Greenwich St., New York 6, N. Y.

"POCKET TALKIE" As Low as \$9.95
REALLY WORKS—talk and hear 2-10 miles or more—FITS IN YOUR POCKET! Uses flashlight batteries—ABOUT SIZE OF 2 PACKS CIGARETTES! Wt. 1 LB. SEND \$1.00 (\$1.52 C.O.D.) for EZ to read plans—assembly instructions—pictures and parts price lists with DETAILED CATALOGUE ON 135 OTHER PRODUCTS SUCH AS: (\$1.00 refunded on parts order) 3-tube Pocket Radio Clear Box Transmitter, Dash Car Transmitter, Radio Garage Door Opener, MOTOR INDUSTRIES, Dept. CW-12, Kearney, Neb.

XMAS SPECIALS

3 TUBE PHONO AMPLIFIER

\$1.95



COMPLETELY WIRED, VOLUME AND TONE CONTROLS

- Set of 3 tubes; 50L6, 35Z5, 12A6 \$1.10
- Output trans. 50L635
- 1/2 Meg. vol. control with sw.35
- 1" pm speaker95
- 5" pm speaker 1.15
- 6" pm speaker 1.55
- 6x4" pm speaker 1.39
- 8" pm speaker 2.49
- Webster pickups 1.79
- Astatic Cartridges L-70A, L-26A 2.50
- Alliance motor & Turntable 2.50
- VM #400 INTERMIX CHANGER..... 24.95
- G.E. Reluctance Cartridge 4.51
- Phono Pre-Amplifier complete with tubes 4.95
- Phono Oscillator complete with tubes.. 4.52
- Oscillator Coil, 12SA715
- Slow Speed Motor and T.T. 3.89
- Slow Speed Pickup with Perm. Needle 3.89

All prices F.O.B. N.Y.C.—on C.O.D. 25% Deposit. Write for free catalog.

THE ROSE COMPANY

98 Park Place, Dept. C, New York 7, N. Y.

RADIOMEN! ELECTRICIANS!

Get this Valuable Book

FREE

for Merely Examining Coyne's NEW Pay-Raising

5 VOLUME SET APPLIED PRACTICAL RADIO

Here's a PRACTICAL set of radio books just off the press! Gives you "know how" on everything in Radio today. Basic principles to news in Television and F.M.—how construct, install, service. Latest trouble-shooting methods. 1000 illustrations, over 1500 pages. Ideal for reference or home training. To prove how valuable these great books can be to you, Coyne will give you a FREE copy of our new, helpful "50 New Radio Diagrams Explained" for looking over the 5 Vol. Set. OFFER LIMITED—ACT NOW! We will send you 5 vol. set APPLIED PRACTICAL RADIO for 7 days FREE examination, together with Radio Diagrams. Look set over for 7 days. If you like it send \$15 cash, or \$3 after 7 days and \$3 monthly until \$16.75 is paid. If you don't want the set, return it and you owe NOTHING. Either way you keep Diagrams Book Free. SEND NO MONEY! Coupon asks to see books free and get your gift book for doing it! Send coupon NOW!

FREE BOOK COUPON

Educational Book Publishing Division
COYNE ELECTRICAL & RADIO SCHOOL, Dept. 98-TI,
500 South Paulina St., Chicago 12, Illinois
OK. Send me, postpaid, Coyne's new 5 volume set, "APPLIED PRACTICAL RADIO" for 7 Days FREE TRIAL, per your offer. Also send, absolutely FREE, "50 New Radio Diagrams Explained" as a gift.
NAME.....AGE.....
ADDRESS.....
TOWN.....ZONE.....STATE.....

EASY TO LEARN CODE

It is easy to learn or increase speed with an Instructograph Code Teacher. Affords the quickest and most practical method yet developed. For beginners or advanced students. Available tapes from beginner's alphabet to typical messages on all subjects. Speed range 5 to 40 WPM. Always ready—no QRM.

ENDORSED BY THOUSANDS!

The Instructograph Code Teacher literally takes the place of an operator-instructor and enables anyone to learn and master code without further assistance. Thousands of successful operators have "acquired the code" with the Instructograph System. Write today for convenient rental and purchase plans.



INSTRUCTOGRAPH COMPANY

4701 Sheridan Rd., Dept. RE, Chicago 40, Ill.

MICRO-GROOVE

"SARVI" PHONOGRAPH

Play Micro-Groove & Standard Records With This Dual Speed Phonograph



SPECIAL \$39.90

Incl. Fed. Tax RCA Licensed

Has Dual Speed motor and dual crystal pickups. Powerful 3-tube hi-fi amplifier with volume & bass controls. Heavy 5" 1PM spk. 2 Tone Leatherette Carrying Case. We absolutely guarantee this to meet with your satisfaction or your money back in 10 days. Automatic Switching from L-P to Regular Model JH-3 117 V AC. Weight 15 lbs. Model DA-2 Same (case as above). Plays New Micro-Groove Records only. Attaches to your Phonograph, radio or console. 117V AC. Special \$18.90

Remit in Full and We Pay Postage

CHRISTMAS SPECIAL

Portable Phonograph, 3 Tube Amp, 5" Spk. High output. Plays Regular 10" & 12" Records **\$14.95**

PHONO AMPLIFIER

3-TUBE AC-DC Wired and Tested \$1.69 3 at \$1.49



Volume and Tone Controls. Uses 12A6, 35Z5, 50L6. Set of 3 Tubes ... \$1.05 Output Trans.35 5" Alnico Spk. 1.19

PHONO OSC-2 TUBE

Wired & Tested. Uses 35Z5, 12SA7 **\$2.75**

- 2 Tubes \$1.90
- ALLIANCE PHONO MOTORS 2.00
- ASTATIC L-70 PICKUPS 1.79
- VOLUME CONTROLS 500M 19c—W.S. (Switch)29
- ANTENNA LOOPS—10M & SEC12
- 100 FT. 300 OHM LEAD IN 1.05
- SUPERHET VARIABLE COND—365 MFD59
- 8 PUSH BUTTON SWITCH39

25% on C.O.D. orders. Orders Filled as Received FREE CATALOG D—JUST OUT.

RISCO ELECTRONICS

WHOLESALE DISTRIBUTORS

25 West Broadway, N. Y. 7, N. Y.

TALK ANYWHERE

Instantly To Anyone with Inter-Talkie! Just Push buttons and talk to or from 7 different places! Not a phone—loud room volume—no electric "plug-ins" or tubes needed! Sit or hang it! Simple and quick to hook up. For homes, offices, stores, farms, etc. ONLY \$9.97 EACH free details today! GUARANTEED! Write for MIDWAY SALES CO., Dept. RE-12, Kearney, Nebr.



HEADSET H-16U SPECIAL

8000 ohm Dual Headset H-16/U—most sensitive phones built—noiseproof—may be used as a sound powered intercom—Also used with simple Xtal to make a complete radio receiver—light, durable, efficient, molded, soft neoprene earcups, shaped to snugly and comfortably envelop the entire ear. Everyone HATES NEW. Complete with illustrated manual. Send money order or check today. **\$1.89**

Special per pair Plus 25c each for postage

ATTENTION Amateurs-Experimenters-Inventors

Cut your cost on radio supplies and equipment in half. Clip coupon today. Hundreds of "hard to get" war surplus items along with the best in standard brand equipment—all at great savings to you. Let us know your particular requirements. IMMEDIATE DELIVERY.

PLEASE PUT MY NAME ON YOUR MAILING LIST FOR SPECIAL BULLETINS.

NAME.....

ADDRESS.....ZONE.....

CITY.....STATE.....

NIAGARA RADIO SUPPLY CORP.

160 Greenwich St., New York City 6, N. Y.

Index to Advertisers

Allied Radio Corporation	49
Amplifier Corporation of America	66, 78, 87, 89, 95
Audel Publishers	77
Bargain Radio	91
Bell Telephone Laboratories	8
Brooks Radio Distributing Co.	67, 97
Buffalo Radio Supply	69
Burstein-Appelbee Company	70
Capitol Radio Engineering Institute	6, 71
Cinex Corporation	97
Cleveland Institute of Radio	15
Communications Equipment Company	79
Coyne Electrical School	89, 96
DeForest's Training Institute	9
Electronic Corp. of America	80
Electronic Development Co.	73
Electro-Voice Mfg. Co.	53
Engineering Associates	86
Espey Manufacturing Co.	91
Fair Radio Sales	89
Feller Engineering Company	95
Franklin-Ellis	79
General Cement Manufacturing Co.	85
General Electronic Distributing Co.	65, 84
General Test Equipment	86
Greylock Electronic Supply Co.	86
Hallcrafters Company	70
Heath Company	16, 17, 18, 19
Hotel Strand	88
Hudson Specialties	92
Industrial Devices, Inc.	86
Instructograph Company	96
International Resistance Company	11
Joyce Radio Distributing Company	78
Lafayette-Concord	55
Lifetime Sound Equipment Company	86
Leotone Radio Corporation	78
McMurdo Silver Company	Inside Front Cover
P. R. Mallory & Company, Inc.	Inside Back Cover
Merit Products	93
Metropolitan Electronic & Instrument Co.	92
Microcircuits Company	77
Mid-America Company	90
Midway Sales Company	86, 89, 96
Midwest Radio Corporation	63
Morf's Radio Shack	93
Moss Electronic Distributing Company	81
Motor Industries Company	95
Murray Hill Books, Inc.	66, 75
National Radio Institute	3
National Schools	5
Newark Electrical Company	93
Niagara Radio Supply Co.	95, 96
Offenbach & Reimus Co.	89
Ohmrite Manufacturing Company	14
Opad-Green Company	84
Opportunity Adlets	87
Precision Apparatus Company	88
Progressive Electronics Company	88
Radio Corporation of America	Back Cover
The Radio Craftsmen, Inc.	74
Radio Dealers Supply Company	77
Radio-Electronics Library Series	91
Radio Engineering Products Ltd.	86, 87
Radionic Equipment Company	95
Radio Publications	95
Radio Supply & Engineering Company	82
Risco Electronics	96
The Rose Company	96
The Rosicrucians	97

RADIO SCHOOL DIRECTORY (page 94-95)

American Radio Institute	
Baltimore Technical Institute	
Candler System Company	
Commercial Radio Institute	
Don Martin School of Radio Arts	
Hollywood Sound Institute, Inc.	
Lincoln Engineering School	
Milwaukee School of Engineering	
RCA Institutes	
Radio Television Institute	
Radio Training Association of America	
Tri-State College	
Western Radio Communications Institute	
YMCA Trade & Technical Schools	
Howard W. Sams & Co., Inc.	13
Senco Radio, Inc.	83
N. Silverstine	12
Solar Manufacturing Corp.	4
South River Metal Products	10
Sprague Products Company	20
Sprayberry Academy of Radio	7
Superior Instruments	85
Sylvania Electric Products	57
Technical Radio Parts Company	92
Television Assembly Co.	73, 76, 86, 92, 93
Transvision	62
Universal General Corporation	76
Wells Sales, Inc.	98
Wright, Inc.	73

UNDERSTANDING TELEVISION, by Orrin E. Dunlap, Jr. Published by Greenberg, New York, N. Y. 5½ x 8 inches, 128 pages. Price \$2.50.

Written to explain television to the layman, this book begins with a brief historical survey, then tells the reader in general terms "what you see by television."

Containing a large number of excellently reproduced pictures of equipment and of telecast scenes, the volume consists mostly of an easy-to-read discussion summarizing, in effect, the popular-type articles and news stories which have appeared in recent years concerning television's entertainment value and future. Included, too, are brief stories of behind-the-scenes operations, a glossary of technical terms, and a bibliography, as well as a chapter on "What Performers Should Know About Television."—*R. H. D.*

RADIO STATION MANAGEMENT, by J. Leonard Reinsch. Published by Harper & Brothers, 177 pages, 5½ x 8½ inches. Price \$3.50.

Standard practices of the broadcasting industry are set forth in this book. Though the material is reasonably complete, it is difficult to see how anyone unfamiliar with broadcasting could get from the text more than a sketchy idea of operating a station; those with broadcasting experience are already familiar with almost all of the material presented.

No technical information is included, but brief listings of the duties of chief engineer and operators are given, together with sample forms for program and transmitter logs, trouble reports, preventive maintenance, and the like.—*R. H. D.*

ELECTRONIC INSTRUMENTS. (Volume 21 of the M.I.T. Radiation Laboratory Series) edited by Ivan A. Greenwood, Jr., J. Vance Holdam, Jr. and Duncan Macrae, Jr. Published by McGraw-Hill Book Company, 6½ x 9¼ inches, 721 pages. Price, \$9.00.

The electronic instruments discussed are those of most importance in radar and allied electronic applications. The instruments are divided into four classes: electronic computers, servo-mechanisms, voltage and current regulators, and pulse test equipment.

The material is illustrated with formulas, mathematical examples, charts, and schematic and block diagrams. A number of the schematics cover existing equipment and are complete with parts values.

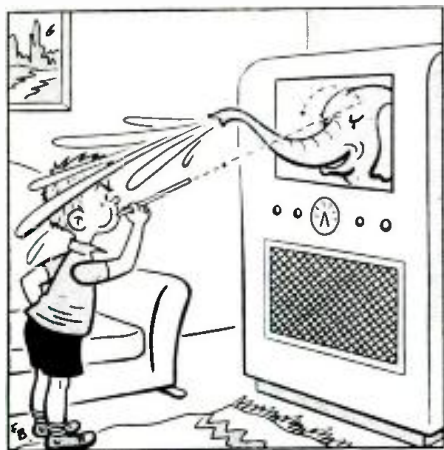

Suggested by Carlton Phillips, Corning, N. Y.

This book is of major interest to design engineers and engineering students. Much of it is also worth-while reading for experimenters and persons working with specialized electronic equipment.—*R.F.S.*

ELEMENTS OF ACOUSTICAL ENGINEERING, by Harry F. Olson. Second Edition. Published by D. Van Nostrand Company, 539 pages, 6 x 9 inches. Price \$7.50.

This standard work needs little comment, except to report that it has been revised and modernized throughout. The second edition is 195 pages longer than the first. This increase appears throughout the book, each chapter containing more subject matter than its first-edition counterpart.

Two new chapters, "Underwater Sound" and "Supersonics and Ultrasonics," have been added. Supersonic in this case refers to any sound of very great intensity.

The illustrations have also been revised and increased in number. Out of the 342 illustrations in the second edition, 145 are new ones.

TELEVISION SIMPLY EXPLAINED, by Maj. Ralph W. Hallows. Published by Chapman and Hall, Ltd., London. 5 x 8 inches, 198 pages. Price 9 shillings sixpence.

Major Hallows' genial style of writing and his facility for lucid explanation are familiar to RADIO-ELECTRONICS readers. Both are apparent in this elementary television book. Much of the geniality has been sacrificed, however, to compactness, since a complete explanation of the workings of television has been compressed into less than 200 pages.

Not a manual for technicians, the book was written to answer the layman's questions about picture transmission. Though the impression sometimes exists that laymen cannot understand any phase of electronics without long study, it is hard to see how a clearer, more readable explanation could be written. The author begins with a chapter entitled "Sound and the Ear—Light and the Eye" and carries the reader in logical sequence through every principal phase of television.

Perhaps it is the plentiful use of analogies that makes things so clear. Undoubtedly, large contribution was made by the author's self-discipline; though obviously thoroughly schooled in the subject, he allowed himself no assumptions of knowledge on the reader's part, but followed his theme from beginning to end without an unfilled gap, reciting in a few places some of the simplest facts known to radiomen but which are not known to non-technical readers.

As a result, a reading of this book (a one- or two-evening project) will prove to be an excellent antidote for the feeling of wonderment existing in the minds of many members of the viewing public. And technical men who have not previously worked with television will do well to begin their studies with this volume, using it to obtain a preliminary eagle's-eye view before settling down to more specialized study of the subject.—*R.H.D.*

SPECIAL FOR SCHOOLS



ROSIN CORE SOLDER
59¢ lb.

SUPPLIED IN 1 or 5 lb. SPOOLS

ALSO

ESICO SOLDERING IRONS

60 WATT, LIST \$2.95, YOUR COST \$1.77
100 WATT, LIST \$3.95, YOUR COST 2.36

Brooks Radio Dist. Corp.

80 VESEY ST., Dept. 5, NEW YORK 7, N.Y.

MIND POWER

A FREE BOOK

Develop your personal, creative power! Awaken the silent, sleeping forces in your own consciousness. Become Master of your own life. Push aside all obstacles with a new energy you have overlooked. The Rosierucians know how, and will help you apply the greatest of all powers in man's control. Create health and abundance for yourself. Write for Free book, "The Mastery of Life." It tells how you may receive these teachings for study and use. It means the dawn of a new day for you. Address: Scribe R. R. S.

The ROSIERUCIANS
SAN JOSE (AMORC) CALIFORNIA

PHOTOFISH EQUIPMENT KIT

FAMOUS WAR SURPLUS AIRCRAFT FLASH UNIT

PURCHASED DIRECT FROM U.S. GOVERNMENT

All amateurs and professionals should have it. The Power Supply and 4 high speed Edgerton Flash Tubes. Plastic sealed, Unbreakable; Light output 110 Watt sec. 2 Condensers, total 50 mfd. made to be used with Batteries, but we furnish without extra charge all necessary parts, Bolts, Connectors, Cords, Spares and Transformer with Diagrams and Instructions to CONVERT to 110 Volt A.C.; you can use battery or power with a flick of the switch.

\$68.00

BRAND NEW—NEVER BEEN USED All complete

A terrific war surplus bargain while they last
CINEX INC. (Dept. ER) 165 W. 46th St., N.Y. 19, N.Y.

NEW PRINTED LEARN FUN CIRCUITS PROFIT

RESEARCH-DESIGN-REPAIR-MFG.

Made Faster and Easier

Be first to learn the new printed-circuit methods. Most new radios have partly printed circuits. Paint working circuits over your rough sketches. Kits of conductor and resistor paints; Standard \$3, Super \$3 (has silver paint). Complete repair and design instructions. Quantity discounts. High instruction value for colleges. Free price lists and literature. Just enclose cash, M.O. or COD plus 25% with name and address, and this ad with kit desired underlined.
MICROCIRCUITS CO., Dept. 20, New Buffalo, Michigan

TRANSMITTING

Mica

CONDENSERS

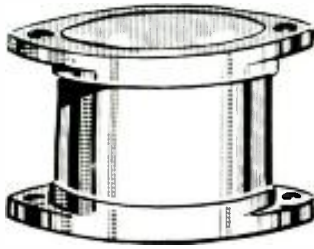

STYLE "A"



STYLE "AA"

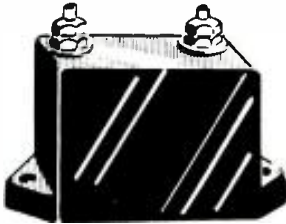

STYLE "B"



STYLE "C"

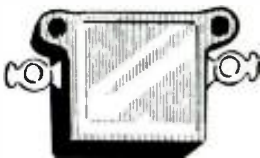

STYLE "D"

SPECIAL LOW PRICES FOR IMMEDIATE SALE AND DELIVERY

We have literally hundreds of thousands of these top quality standard type transmitting mica condensers in stock for immediate delivery at a fraction of their original cost. Every condenser is brand new and carries the name of a fine nationally known manufacturer.

Despite the unusually low prices, these mica condensers, like all Wells Components, are fully guaranteed. Be sure to order sufficient quantities for your requirements.

Cap Mfd	Wrkg. Volt.	Price Each
STYLE "AA" CONDENSERS		
.04	1000	\$3.50
.02	3000	4.50
.002	35000	15.00
STYLE "A" CONDENSERS		
25 MMFD	10,000	\$1.65

Cap Mfd	Wrkg. Volt.	Price Each
STYLE "B" CONDENSERS		
.0000425	5000	\$0.80
.00005	3000	.75
.00007	1140	.70
.00003	3000	.75
.00004	3000	.75
.00009	3000	.75
.000091	3000	.80
.00107	3500	.85
.001	3000	.85
.00015	6000	1.15
.00015	5000	1.05
.0001	5000	.85
.000175	3000	1.05
.0002	1430 AC	1.00
.0002	5000	1.05
.00022	5000	1.05
.00025	5000	1.10
.0003	3000	.95
.00036	5000	1.10
.0004	3000	.95
.0004	5000	1.10
.00047	3000	1.00
.0005	3000	1.00
.0005	5000	1.15
.00055	5000	1.15
.00056	3000	1.00
.00056	5000	1.15
.000625	3000	1.05
.0007	3000	1.05
.00075	5000	1.15
.0008	5000	1.15
.0008	3000	1.00
.00095	5000	1.15
.001	4500	1.25
.001	3000	1.15
.001	5000	1.30
.00125	2000	1.10
.0011	5000	1.35
.0015	3000	1.10
.0015	5000	1.40
.0018	2000	1.10
.002	3000	1.10
.002	5000	1.40
.002	6000	1.75
.0024	3000	1.15
.0024	5000	1.50
.003	3000	1.60
.003	5000	1.70
.004	3000	1.50
.005	2500	1.40
.005	5000	1.70
.0056	3000	1.30
.006	3500	1.45
.0068	3000	1.40
.008	3000	1.45

Cap Mfd	Wrkg. Volt.	Price Each
STYLE "C" CONDENSERS		
.000005	2500	\$0.40
.00005	2500	.40
.0001	2500	.40
.0001	1250	.35
.0001	600	.25
.00015	2500	.40
.00015	1250	.35
.000175	2500	.40
.000175	1500	.35
.0002	2500	.40
.0002	1500	.35
.0002	600	.25
.00022	2500	.45
.00022	1250	.35
.00024	2500	.45
.00025	2500	.45
.00025	1200	.35
.0003	2500	.45
.00039	2500	.50
.0004	2500	.45
.0004	1200	.35
.0005	2500	.45
.00051	2500	.55
.00056	2500	.55
.000575	1500	.60
.0006	1250	.45
.0007	1250	.45
.0008	1250	.45
.0008	1000	.35
.00085	1200	.40
.001	2500	.55
.001	1200	.40
.001	600	.35
.0011	2500	.55
.0012	1250	.50
.00125	1200	.45
.0015	1200	.45
.0018	1200	.50
.002	1200	.45
.002	2500	.55
.0022	2500	.60
.0022	1200	.45
.0024	1200	.50
.0025	1250	.50
.0027	1250	.55
.00275	1200	.60
.003	1200	.55
.0035	2500	.60
.00375	2500	.65
.00375	1000	.45
.0039	1250	.55
.004	2500	.60
.004	1250	.45
.0043	2500	.65
.0045	1000	.45
.0047	1250	.55
.0046	500	.45
.005	2500	.60

Cap Mfd	Wrkg. Volt.	Price Each
STYLE "D" CONDENSERS		
.00004	600	\$0.20
.0001	1250	.25
.0001	600	.20
.00015	1200	.25
.00015	600	.20
.000175	1000	.30
.0002	1200	.25
.0002	600	.20
.00025	2500	.35
.00025	1200	.25
.00025	600	.20
.0004	2500	.35
.0004	1200	.25
.0005	2500	.35
.0005	1200	.30
.0005	600	.20
.00051	2500	.35
.00052	2000	.35
.00055	2500	.40
.00056	1200	.35
.0006	2500	.35
.0006	1200	.25
.00065	600	.25
.0007	600	.25
.0008	1000	.35
.00085	1200	.35
.001	2500	.40
.001	1250	.35

Cap Mfd	Wrkg. Volt.	Price Each
.001	600	.25
.0012	600	.30
.0015	1200	.35
.0018	1200	.40
.002	2500	.40
.002	1200	.35
.002	600	.25
.0022	2500	.40
.0022	1200	.30
.0022	600	.25
.0024	1200	.25
.0025	2500	.40
.0025	1200	.30
.0027	1200	.30
.003	1200	.30
.003	2000	.40
.00375	1000	.40
.0039	1200	.40
.004	2500	.45
.004	1200	.35
.004	600	.25
.0044	600	.25
.0043	1200	.35
.0045	600	.30
.0047	2500	.40
.0047	1200	.30
.005	2500	.40
.005	1250	.30
.005	600	.25
.0051	1200	.35
.0051	600	.30
.0056	1200	.35
.0056	600	.30
.006	1200	.35
.006	600	.25
.0068	1200	.35
.007	600	.30
.008	1200	.35
.008	600	.30
.009	600	.30
.01	1250	.40
.01	600	.30
.01	2500	.50
.015	1250	.40
.015	600	.30
.015	600	.35
.0175	1200	.40
.02	2500	.65
.02	1250	.45
.02	600	.35
.025	1250	.55
.03	1200	.50
.04	1200	.55
.04	1000	.45
.04	600	.35
.047	1200	.50
.047	600	.40
.056	1000	.55
.06	1000	.50
.073	500	.40
.09	1000	.55
.09	600	.45
.1	1000	.60
.1	600	.45

This is only a partial listing. Write or wire for information on types not shown and for receiving set micas and silver micas.

We advise distributors to order immediately from this ad. Our standard jobber arrangement applies.

Manufacturers and Distributors: Write for our complete Mica Condenser Listing No. 103A.



320 N. LA SALLE ST. DEPT. Y, CHICAGO 10 ILL.

RADIO-ELECTRONICS for DECEMBER, 1948



Get Acquainted with the Little Fellow with the **BIG** Advantages

The All New Mallory Midgetrol



Offers These **BIG** Advantages ...

BIGGER MARKET

The small size of the Mallory Midgetrol lets you service portables, auto radios and small AC-DC receivers which require $15/16''$ controls.

SIMPLER INSTALLATION

The unique shaft design of the Mallory Midgetrol saves installation time with *all* types of knobs.

SIMPLER STOCKING

Electrical characteristics let you use the Mallory Midgetrol to replace $1/8''$ as well as $15/16''$ controls. Stocks are further reduced because no special shafts are needed.

Both mechanically and electrically, the Mallory Midgetrol is amazingly quiet. Tests prove it *stays* quiet! And the Mallory Midgetrol offers nine *all new* features.

It's the *NEW* Standard in Carbon Controls. See your Mallory distributor.

- NEW SIZE
- NEW DESIGN
- NEW SHAFT
- NEW EXTENSION
- NEW SWITCH
- NEW ELEMENT
- NEW CONTACT
- NEW TERMINAL
- NEW TWO-POINT SUSPENSION

P. R. MALLORY & CO. Inc.
MALLORY

CAPACITORS ... CONTROLS ... VIBRATORS ...
SWITCHES ... RESISTORS ... RECTIFIERS ...
VIBRAPACK* POWER SUPPLIES ... FILTERS
*Reg. U. S. Pat. Off.

APPROVED PRECISION PRODUCTS

P. R. MALLORY & CO., Inc., INDIANAPOLIS 6, INDIANA



Push RCA Tubes and Watch Your Business Grow!



Sell more service . . . sell more RCA tubes . . . by displaying this dramatic 8-color, 22" x 28" girl poster.

In miniatures . . . it's RCA!

THE TREND IS TO MORE MINIATURES . . . in midget and auto sets . . . FM and TV receivers . . . commercial and industrial equipment.

Whether miniature, or metal, or glass . . . RCA provides you with the greatest line of tubes to sell . . . and the outstanding line of sales promotion displays to help you sell them.

When you push RCA tubes you're selling the brand

that holds No. 1 customer acceptance. RCA tubes help your business grow because they build store traffic . . . lead customers to count on you for *all* their radio needs.

So . . . *Push RCA Tubes and watch your business grow!* For full details on sales promotion displays, see your local RCA Tube Distributor today.

THE FOUNTAINHEAD OF MODERN TUBE DEVELOPMENT IS RCA



TUBE DEPARTMENT

RADIO CORPORATION of AMERICA

HARRISON, N. J.