

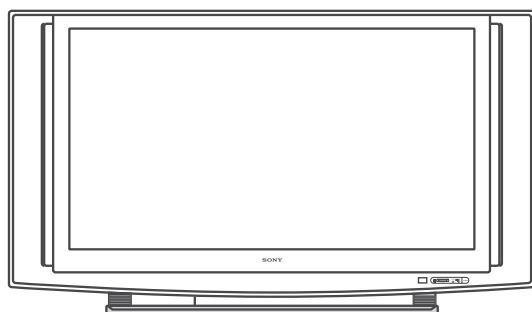

# SERVICE MANUAL SP-1 CHASSIS

<u>MODEL</u>	<u>COMMANDER</u>	<u>DEST.</u>	<u>CHASSIS NO.</u>	<u>MODEL</u>	<u>COMMANDER</u>	<u>DEST.</u>	<u>CHASSIS NO.</u>
KDS-R50XBR1	RM-Y914	USA					
KDS-R50XBR1	RM-Y914	CANADA					
KDS-R50XBR1	RM-Y914	MEXICO					
KDS-R60XBR1	RM-Y914	USA					
KDS-R60XBR1	RM-Y914	CANADA					
KDS-R60XBR1	RM-Y914	MEXICO					



KDS-R50XBR1/R60XBR1

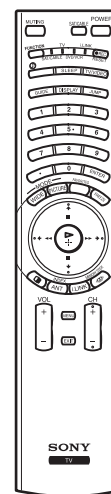

RM-Y914

**SXRD PROJECTION TV**

**SONY®**

## Specifications

Projection System	3 SXRD Panel, 1 lens projection system	
SXRD Panel	0.61 inch SXRD panel 6,220,800 pixels (2,073,600 × 3)	
Projection Lens	High Performance, large diameter hybrid lens F2.5	
Antenna	75 ohm external terminal for VHF/UHF	
Lamp	UHP lamp, 120W, XL-5100	
Television System	NTSC	American TV Standard
	ATSC (8VSB terrestrial)	ATSC compliant 8VSB
	QAM on cable	ANSI/SCTE 07 2000
Visible Screen Size (picture measured diagonally)	KDS-R50XBR1: 50 inches KDS-R60XBR1: 60 inches	
Channel Coverage	Terrestrial (analog)	2-69
	Cable TV (analog)	1-125
	Terrestrial (digital)	2-69
	Cable TV (digital)	1-135
Power Requirements	120V, 60 Hz	
Inputs/Outputs		
HDMI IN	2 total	Video: 1080i, 720p, 480p, 480i Audio: Two channel linear PCM 32, 44.1 and 48 kHz, 16, 20 and 24 bit
Video (IN)	3 total (1 on front panel)	1 Vp-p, 75 ohms unbalanced, sync negative
S Video (IN)	3 total (1 on front panel)	Y: 1 Vp-p, 75 ohms unbalanced, sync negative C: 0.286 Vp-p (Burst signal), 75 ohms
Audio (IN)	6 total (1 on front panel)	500 mVrms (100% modulation) Impedance: 47 kilohms
Component Video Input	2 (YPbPr)	Y: 1 Vp-p, 75 ohms unbalanced, sync negative Pb: 0.7 Vp-p, 75 ohms Pr: 0.7 Vp-p, 75 ohms
CONTROL S (IN)	1	Mini jack
CONTROL S (OUT)	1	Mini jack
AUDIO OUT (VAR/FIX)	1	500 mVrms at the maximum volume setting (Variable) 500 mVrms (Fixed) Impedance (output): 2 kilohms

**Other Information**

PC IN	D-sub 15-pin, analog RGB, 0.7 Vp-p, 75 ohms, positive	
i.LINK	3 total (1 on front panel)	4-pin S400 i.LINK terminal
RF Inputs	2	
Digital Audio Optical Output (PCM/Dolby Digital)	1	Optical Rectangular (1)
CableCARD Slot	PCMCIA Type I/II	
Speaker Output	15 W (L), 15 W (R)	
Dimensions (W H D)	KDS-R50XBR1 1,453 × 863 × 478 mm (57 1/4 × 34 × 18 7/8 inches) KDS-R60XBR1 1,674 × 1,009 × 514 mm (66 × 39 3/4 × 20 1/4 inches)	
Mass	KDS-R50XBR1 43kg (94 lb. 13 oz.) KDS-R60XBR1 51kg (112 lb. 7 oz.)	
Power Consumption		
In Use	240 W	
In Standby	0.5 W	
In i.LINK/CableCARD Standby	Less than 30 W	
Supplied Accessories		
Remote Control	RM-Y914	
AA (R6) Batteries	2 supplied for remote control	
Operating Instructions	1	
Quick Setup Guide	1	
Warranty	1	
Product Registration Card	1	

Design and specifications are subject to change without notice.

## Indicators

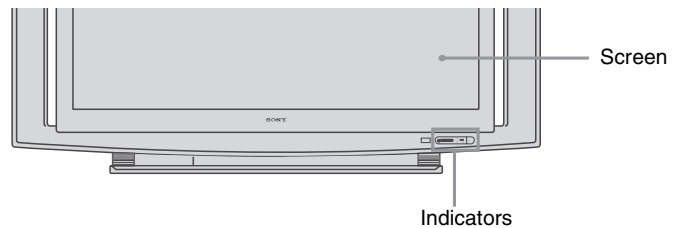

The indicators show the current status of your TV. If there is a change in the condition or a problem with the TV, the indicators will flash or light up in the manner described below to let you know that it requires your attention.

<b>Indicator</b>	<b>Flashing because...</b>	
POWER/ STANDBY flashing	Green	The lamp for the light source is preparing to turn on. When it is ready, it turns on.
	Red	The lamp door or the lamp is not securely attached. The red indicator will continue to flash in intervals of three blinks at a time until the lamp door or the lamp is placed correctly. The red indicator is on when i.LINK STANDBY is on or when your TV is in the PC power saving mode.
LAMP indicator flashes	The projection lamp has burned out. Replace it with new one (see page 5 ).	
TIMER indicator is lit	When one of the timers is set the indicator will remain lit (will not flash) even when the TV is turned off.	

## Projection Lamp

Your TV uses a projection lamp as its light source. As with any lamp, it has limited life and needs to be replaced when the Lamp indicator flashes or the screen becomes darker. Note the following:

- After turning on your TV, it may take a while (1 minute or less) before the picture appears.
- When the projection lamp wears out, the screen goes dark. Replace the lamp with a new Sony XL-5100 replacement lamp (not supplied).

 **The light emitted from the lamp is quite bright when your TV is in use. To avoid eye discomfort or injury, do not look into the light housing when the power is on.**

## Replacing the Lamp

The projection lamp, which illuminates the picture, has a limited life.

If the screen becomes dark, the color looks unusual, or the LAMP indicator on the front of the TV flashes, this indicates the lamp needs to be replaced with a new one (not supplied).





### WARNING

**Electric appliances can cause fire or high temperature, resulting in injury or death. Be sure to follow the instructions below.**

- Use a Sony XL-5100 replacement lamp (not supplied) for replacement. Use of any other lamp may damage the TV.
- Do not remove the lamp for any purpose other than replacement. Doing so may cause injury or fire.
- Do not put flammable materials and metal objects inside the lamp receptacle of the TV after removing the lamp. Doing so may cause fire or electrical shock. Do not touch the lamp receptacle once the lamp has been removed.
- When the lamp eventually burns out, you may hear a noticeable “pop” sound. This is normal and it is inherent to this type of lamp.
- In rare instances, the bulb may pop inside the lamp unit, but the lamp unit is designed to contain all of the broken glass pieces inside the lamp unit.
- The lamps contain mercury. For proper disposal of the used lamps, follow and observe the local ordinances. See page 107.

## How to Replace the Lamp

- 1** Turn off the power on the main unit. Wait several minutes, then unplug the power cord.  
(The cooling fan will continue to operate for about two minutes after turning the power off.)
- 2** Wait at least 30 minutes after unplugging the power cord to allow the lamp to cool down before replacing it. To avoid being burned, do not touch the lamp receptacle once the lamp has been removed.
- 3** Take the new lamp out of its package.  
Do not touch the glass portion of the new lamp.

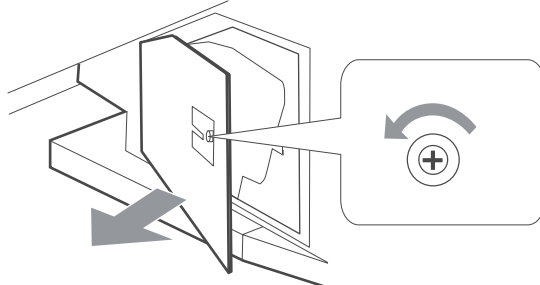

-  **Do not shake the lamp. Vibration can damage the lamp or shorten its life.**
-  **Avoid touching the front glass of a new lamp or the glass of the lamp receptacle. This may reduce picture quality or lamp life.**

- 4** Turn the screw with a screwdriver counterclockwise and remove the outside lamp cover.

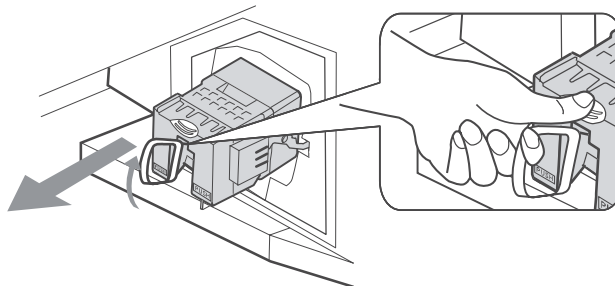

- 5** Pull out the lamp.  
Place your index finger through the hoop of the lamp handle and pull it upwards, while placing your thumb on the dent on the top. Then pull the lamp out.



-  **The lamp is very hot after use. Never touch the glass portion of the lamp or the non-designated surrounding parts (shown in gray).**
-  **After the used lamp has cooled, place it into the empty box of the replacement lamp. Never put the used lamp into a plastic bag.**

*(Continued)*

- 6** Place the lamp halfway in. Follow the gutter in the compartment to mount the new lamp securely.

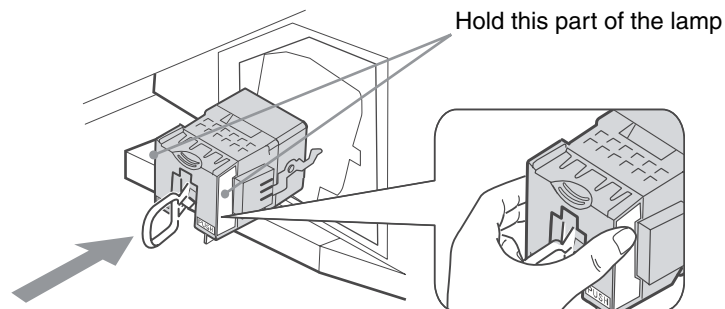

- ⚠** The lamp compartment is tilted, as shown in the following illustration.

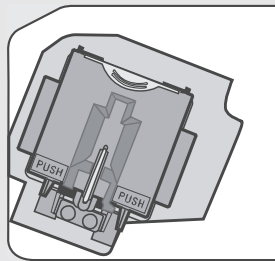

- 7** Slide it in slowly by pressing the **PUSH** part of the front corners of the lamp until it stops with a firm clicking sound to lock.

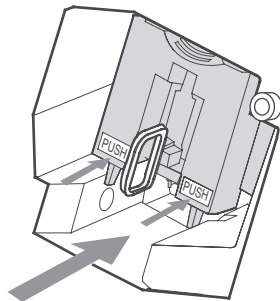



- ⚠** To ensure the lamp is securely installed, press the area marked **PUSH** before closing the lamp cover.
- ⚠** If the lamp is not securely reattached, the self-diagnostic function may be triggered and the POWER/STANDBY indicator flashes in red three times (see page 4).

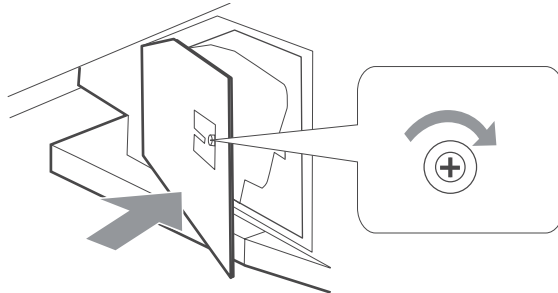

- 8** Place the outside lamp cover back in its place. Turn the screw with a screwdriver clockwise and secure the cover.



-  **Consult your Sony dealer for a Sony XL-5100 replacement lamp.**
-  **Take great care when replacing the lamp or plugging in/unplugging the connecting cords. Rough handling may cause the TV to fall, damaging the TV, the TV stand and the floor.**

#### **The used lamp**

This product contains mercury. Disposal of this product may be regulated if sold in the United States. For disposal or recycling information, please contact your local authorities or the Electronics Industries Alliance (<http://www.eiae.org>).

- Do not leave the used lamp near flammable materials or within the reach of children.
- Do not pour water onto the used lamp or put any object inside the lamp. Doing so may cause the lamp to burst.

**For replacement lamp information visit:**  
**U. S. residents:** <http://www.sonystyle.com/tv/>  
**Canadian residents:** <http://www.sonystyle.ca/tv/>

## SAFETY CHECK-OUT

( US model only )

After correcting the original service problem, perform the following safety checks before releasing the set to the customer:

1. Check the area of your repair for unsoldered or poorly-soldered connections. Check the entire board surface for solder splashes and bridges.
2. Check the interboard wiring to ensure that no wires are "pinched" or contact high-wattage resistors.
3. Check that all control knobs, shields, covers, ground straps, and mounting hardware have been replaced. Be absolutely certain that you have replaced all the insulators.
4. Look for unauthorized replacement parts, particularly transistors, that were installed during a previous repair. Point them out to the customer and recommend their replacement.
5. Look for parts which, through functioning, show obvious signs of deterioration. Point them out to the customer and recommend their replacement.
6. Check the line cords for cracks and abrasion. Recommend the replacement of any such line cord to the customer.
7. Check the condition of the monopole antenna (if any). Make sure the end is not broken off, and has the plastic cap on it. Point out the danger of impalement on a broken antenna to the customer, and recommend the antenna's replacement.
8. Check the B+ and HV to see they are at the values specified. Make sure your instruments are accurate; be suspicious of your HV meter if sets always have low HV.
9. Check the antenna terminals, metal trim, "metallized" knobs, screws, and all other exposed metal parts for AC leakage. Check leakage as described below.

### LEAKAGE TEST

The AC leakage from any exposed metal part to earth ground and from all exposed metal parts to any exposed metal part having a return to chassis, must not exceed 0.5mA (500 microampers). Leakage current can be measured by any one of three methods.

1. A commercial leakage tester, such as the Simpson 229 or RCA WT-540A. Follow the manufacturers' instructions to use these instruments.
2. A battery-operated AC milliammeter. The Data Precision 245 digital multimeter is suitable for this job.
3. Measuring the voltage drop across a resistor by means of a VOM or battery-operated AC voltmeter. The "limit" indication is 0.75V, so analog meters must have an accurate low-voltage scale. The Simpson 250 and Sanwa SH-63Trd are examples of a passive VOM that is suitable. Nearly all battery-operated digital multimeters that have a 2V AC range are suitable. (See Fig. A)

### HOW TO FIND A GOOD EARTH GROUND

A cold-water pipe is guaranteed earth ground; the cover-plate retaining screw on most AC outlet boxes is also at earth ground. If the retaining screw is to be used as your earth-ground, verify that it is at ground by measuring the resistance between it and a cold-water pipe with an ohmmeter. The reading should be zero ohms. If a cold-water pipe is not accessible, connect a 60-100 watt trouble light (not a neon lamp) between the hot side of the receptacle and the retaining screw. Try both slots, if necessary, to locate the hot side of the line, the lamp should light at normal brilliance if the screw is at ground potential. (See Fig. B)

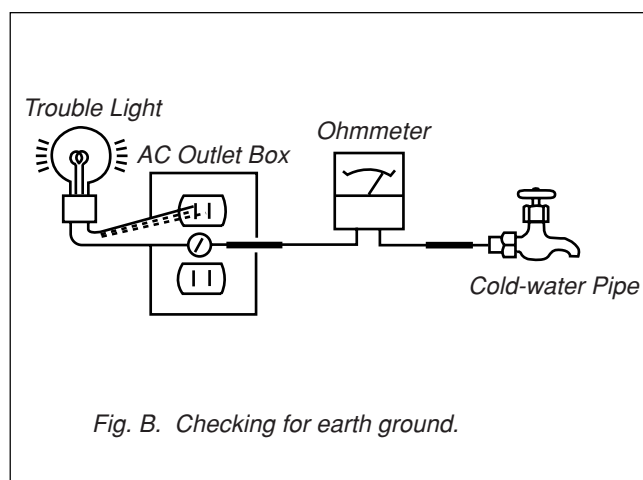
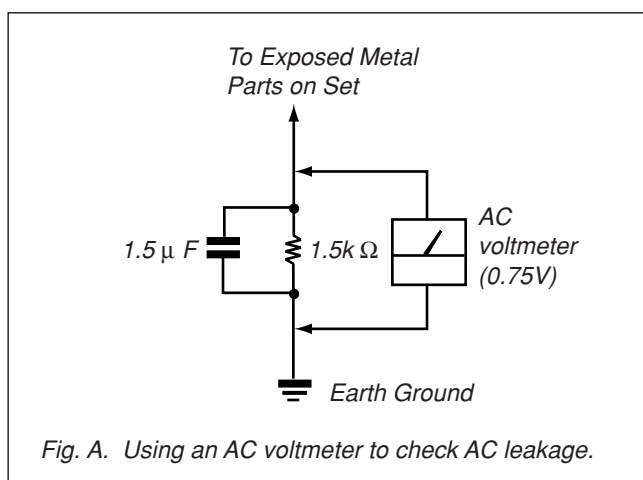

**CAUTION**

These servicing instructions are for use by qualified service personnel only.

To reduce the risk of electric shock, do not perform any servicing other than that contained in the operating instructions unless you are qualified to do so.

**WARNING!!**

AN ISOLATION TRANSFORMER SHOULD BE USED DURING ANY SERVICE TO AVOID POSSIBLE SHOCK HAZARD, BECAUSE OF LIVE CHASSIS. THE CHASSIS OF THIS RECEIVER IS DIRECTLY CONNECTED TO THE AC POWER LINE.

**SAFETY-RELATED COMPONENT WARNING!!**

COMPONENTS IDENTIFIED BY SHADING AND MARK  $\triangle$  ON THE SCHEMATIC DIAGRAMS, EXPLODED VIEWS AND IN THE PARTS LIST ARE CRITICAL TO SAFE OPERATION. REPLACE THESE COMPONENTS WITH SONY PARTS WHOSE PART NUMBERS APPEAR AS SHOWN IN THIS MANUAL OR IN SUPPLEMENTS PUBLISHED BY SONY. CIRCUIT ADJUSTMENTS THAT ARE CRITICAL TO SAFE OPERATION ARE IDENTIFIED IN THIS MANUAL. FOLLOW THESE PROCEDURES WHENEVER CRITICAL COMPONENTS ARE REPLACED OR IMPROPER OPERATION IS SUSPECTED.

**ATTENTION!!**

AFIN D'EVITER TOUT RISQUE DELECTROCUTION PROVENANT D'UN CHÂSSIS SOUS TENSION, UN TRANSFORMATEUR D'ISOLEMENT DOIT ETRE UTILISÉ LORS DE TOUT DEPANNAGE.

LE CHÂSSIS DE CE RECEPTEUR EST DIRECTEMENT RACCORDÉ À L'ALIMENTATION SECTEUR.

**ATTENTION AUX COMPOSANTS RELATIFS À LA SÉCURITÉ!!**

LES COMPOSANTS IDENTIFIÉS PAR UNE FRAME ET PAR UNE MAPQUE  $\triangle$  SUR LES SCHÉMAS DE PRINCIPE, LES VUES EXPLOSÉES ET LES LISTES DE PIÈCES SONT D'UNE IMPORTANCE CRITIQUE POUR LA SÉCURITÉ DU FONCTIONNEMENT. NE LES REMPLACER QUE PAR DES COMPOSANTS SONY DONT LE NUMÉRO DE PIÈCE EST INDIQUÉ DANS LE PRÉSENT MANUEL OU DANS DES SUPPLÉMENTS PUBLIÉS PAR SONY. LES RÉGLAGES DE CIRCUIT DONT L'IMPORTANCE EST CRITIQUE POUR LA SÉCURITÉ DU FONCTIONNEMENT SONT IDENTIFIÉS DANS LE PRÉSENT MANUEL. SUIVRE CES PROCÉDURES LORS DE CHAQUE REMPLACEMENT DE COMPOSANTS CRITIQUES, OU LORSQU'UN MAUVAIS FONCTIONNEMENT SUSPECTÉ.

## TABLE OF CONTENTS

<u>Section</u>	<u>Title</u>	<u>Page</u>	<u>Section</u>	<u>Title</u>	<u>Page</u>
<b>1. SELF DIAGNOSIS FUNCTION</b>		13	<b>4. DIAGRAMS</b>		
<b>2. DISASSEMBLY</b>			4-1. Block Diagram (1)		25
2-1. Rear Cover		16	Block Diagram (2)		26
2-2. Terminal Bracket, D.C Fan		17	Block Diagram (3)		27
2-3. Service Position		17	Block Diagram (4)		28
2-4. Pod Block Assembly, Antenna Switch		18	Block Diagram (5)		29
2-5. Digital Block Assembly		18	Block Diagram (6)		30
2-6. DC Motor SFF21C/C-NP		19	Block Diagram (7)		31
2-7. Power Supply Block		19	Block Diagram (8)		32
2-8. Unit Cover Assembly, Lamp (R) Guide Assembly		20	Block Diagram (9)		33
2-9. DC Motor SFF22A/C-NP		20	Block Diagram (10)		34
2-10. Optical Block Assembly		21	Block Diagram (11)		35
2-11. Screen Frame Block Assembly		21	Block Diagram (12)		36
2-12. Mirror Cover Block Assembly		22	4-2. Frame Schematic Diagram		37
2-13. H1 Block Assembly		22	4-3. Circuit Boards Location		39
<b>3. ELECTRICAL ADJUSTMENTS</b>			4-4. Schematic Diagrams		39
3-1. Electrical Adjustment by Remote Commander		23	(1) Schematic Diagram of AK Board		40
3-1-1. Method of Setting the Service Adjustment Mode		23	(2) Schematic Diagram of F Board		41
3-1-2. Service Mode Adjustment		23	(3) Schematic Diagram of G (1/3) Board		42
3-1-3. Memory Write Confirmation Method		23	(4) Schematic Diagram of G (2/3) Board		43
3-1-4. Adjusting Buttons and Indicator		24	(5) Schematic Diagram of G (3/3) Board		44
3-2. To read Lamp and Panel time		24	(6) Schematic Diagram of HM Board		45
3-3. Test Reset		24	(7) Schematic Diagram of H1 Board		46
3-4. H/V Center Confirmation and Adjustment		24	(8) Schematic Diagram of H2 Board		47
			(9) Schematic Diagram of H3 Board		48
			(10) Schematic Diagram of QU Board		49
			(11) Schematic Diagram of S1, S2 Boards		50
			(12) Schematic Diagram of T1, T3 Boards		51
			4-5. Printed Wiring Boards		52
			(1) AK Board		52
			(2) F Board		53
			(3) G Board (Side A)		54
			(4) G Board (Side B)		55
			(5) HM, H1 Boards		56
			(6) H2, H3 Boards		57
			(7) QU, S1, S2, T1, T3 Boards		58
			4-6. Semiconductors		59

<u>Section</u>	<u>Title</u>	<u>Page</u>
<b>5. EXPLODED VIEWS</b>		
5-1.	Screen, Covers .....	60
5-2.	Bottomblock-1 .....	61
5-3.	Bottomblock-2 .....	62
5-4.	Bottomblock-3 .....	63
<b>6. ELECTRICAL PARTS LIST</b>		
•	AK Board .....	64
•	F Board .....	65
•	G Board .....	65
•	HM Board .....	69
•	H1 Board .....	70
•	H2 Board .....	70
•	H3 Board .....	70
•	QU Board .....	71
•	S1 Board .....	71
•	T1 Board .....	71
•	T3 Board .....	71

## SECTION 1

## SELF DIAGNOSIS FUNCTION

## 1. Summary of Self-Diagnosis Function

- This device includes a self-diagnosis function.
- In case of abnormalities, the POWER/STANDBY indicator automatically blinks. It is possible to predict the abnormality location by the number of blinks. The Instruction Manual describes blinking of the POWER/STANDBY indicator.
- If the symptom is not reproduced sometimes in case of a malfunction, there is recording of whether a malfunction was generated or not. Operate the remote command to confirm the matter on the screen and to predict the location of the abnormality.

## 2. Diagnosis Items and Prediction of Malfunction Location

- When a malfunction occurs the POWER/STANDBY indicator only blinks for one of the following diagnosis items. In case of two or more malfunctions, the item which first occurred blinks. If the malfunctions occurred simultaneously, the item with the lower blink count blinks first.
- The screen display displays the results regarding all the diagnosis items listed below. The display "0" means that no malfunctions occurred.

Diagnosis Item	Number of times POWER/STANDBY indicator blinks	Probable Cause Location	Defected symptoms
Temp error	2 times	- Set temperture is high. - Temp sensor connector is not attached securely. (CN7020 on HB board, CN7180 on S2 board)	- No picture/No sound
Lamp cover error	3 times	- Lamp cover is not attached securely. -Lamp is not set securely.	- No picture/No sound
Fan stopped	4 times	- Fan 1-4 power is not supplied. (AGU board) - Fan connector is not attached securely. -Fan caught wires or harnesses.	- No picture/No sound
Lamp driver error	5 times	- Lamp driver is faulty.	- No picture/No sound
Low B error	6 times	- B_12V is not supplied. (GT board)	- No picture/No sound
Audio error	7 times	- Short-circuit of Audio power supply line. -Blow out of fuse. (PS3001 on K board) -IC failure. (IC3005 on K board)	- No picture/No sound
D-OVP error	8 times	-B -12V is over voltage. (B board)	- No picture/No sound
ATSC OVP	10 times	-Q_10.5V is over voltage. (GT board)	- No picture/No sound
Lamp error	LAMP-LED flashes	- Lamp for the light source burns out.	- No picture/No sound

### 3. Blinking count display of POWER/STANDBY indicator

- One blink is not used for self-diagnosis.

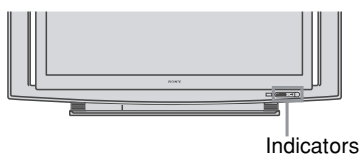

- Example

Diagnosis item      LED blinks

Lamp cover      3 times

Fan      4 times

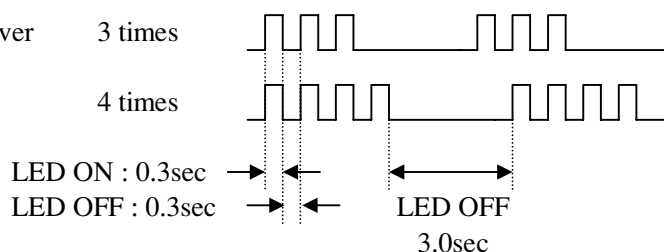

#### - Release of POWER/STANDBY indicator blinking

The POWER/STANDBY indicator blinking display is released by removing the plug from the power or leaving for 2 minutes.

### 4. Self-diagnosis screen displays

- In cases of malfunctions where it is not possible to determine the symptom such as when the power goes off occasionally or when the screen disappears occasionally, there is a screen display on whether the malfunction occurred or not in the past (and whether the detection circuit operated or not) in order to allow confirmation.

#### <Screen Display Method>

- Quickly press the remote command button in the following order from the standby state.

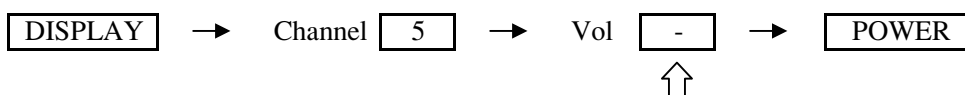

Be aware that this differs from the method of entering the service mode (Vol +).

SELF CHECK		
1	: LAMP_ERROR	0
2	: TEMP_ERROR	0
2	: LAMP_TEMP	0
3	: LAMP_COVER	0
4	: FAN_ERROR	0
5	: LAMP_DRIVER	1
6	: LOWB_ERROR	0
7	: AUDIO_PROT	0
8	: D_OVP	0
10	: ATSC_OVP	0

- Numeral "1" means a fault was detected one time
- Numeral "0" means that no fault was detected

- The results display is not automatically cleared. In case of repairs and after repairs, check the self-diagnosis screen and be sure to return the results display to "0".
- If the results display is not returned to "0" it will not be possible to judge a new malfunction after completing repairs.

#### <Method of Clearing Results Display>

1. Power off (Set to the standby mode)
2. **DISPLAY** → Channel **5** → Vol **-** → **POWER**
3. Channel **8** → **ENTER**

#### <Method of Ending Self-Diagnosis Screen>

- When ending the self-diagnosis screen completely, turn the power switch OFF on the remote commander or the main unit.

### 5. Self-Diagnosis function operation

2	: Temp	When the temperature sensor (for Ambient) on the S1 board detects high temperature or the temperature sensor (for Lamp) on the S2 board detects high temperature or the temperature sensor (for Panel) on the C board detects high temperature, the DE-micro (IC5) turns off the lamp.
3	: Lamp cover	The rib at the back of the lamp cover closes the SW on the T1 board. The lamp closes the SW on the T2 board. It is monitored by DE-micro (pin63 of IC5) and turned off the lamp when it is opened.
4	: Fan	Fan rotation is detected by "FAN-PROT" and the DE-micro (pin92 of IC5) turns off the lamp when it is "high".
5	: Lamp Driver	When the "LAMP-PROT" (pin83 of IC5) is high, the lamp is not turned on. If the "LAMP-HV-DET" (pin94 of IC5) is low at the same time, it classified as no high voltage of the lamp driver.
6	: Low B error	When no "D5V (SW_5V)" is detected, pin 129 of TV-micro (IC7002) is low and it turns off the main power. (for example, blowout of thermal fuse).
7	: Audio	When DC voltage is detected at the speaker output, "SP-PROT" (pin102 of IC5) is low and it turns off the main power.
8	: D-OVP	Be not in use.
9	: Panel error	When there is not ack from the temperature sensor on the S1, S2 and C board or IIC line connector (CN2303: ASU board, CN7956: DSU board, CN6901: C board) is not seated securely. it is monitored by DE-micro.
10	: ATSC-OVP	Be not in use.
LAMP	: Lamp	When the "LAMP-PROT" (pin83 of IC5) is high, the lamp is not turned on. If the "LAMP-HV-DET" (pin94 of IC5) is high at the same time, it classified as no lamp or a dead lamp.



## SECTION 2 DISASSEMBLY

Photo: KDS-R50XBR1

### 2-1. REAR COVER

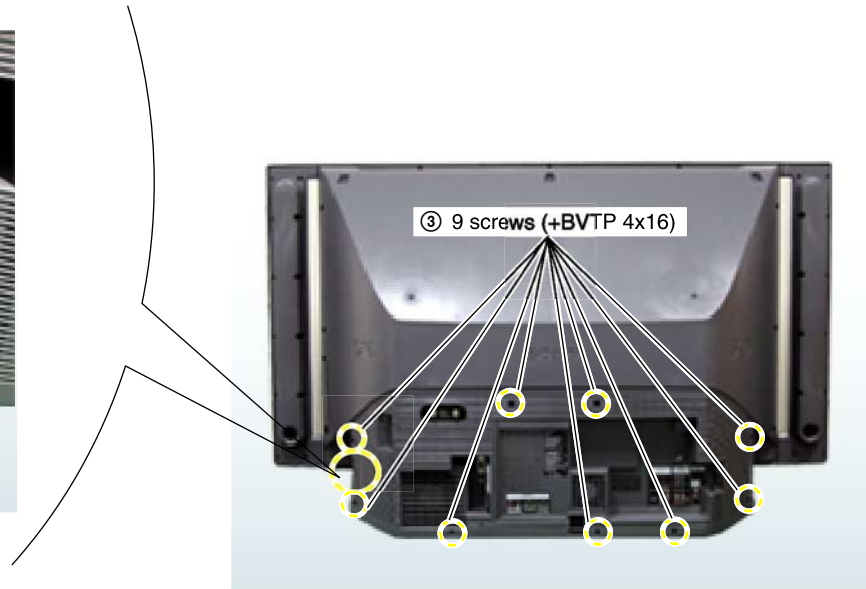
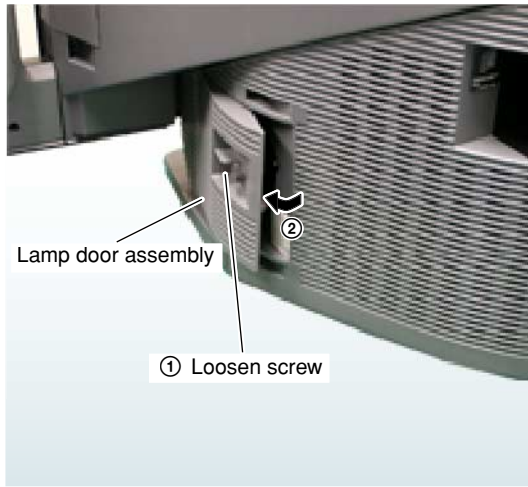

2-2. TERMINAL BRACKET, D.C FAN

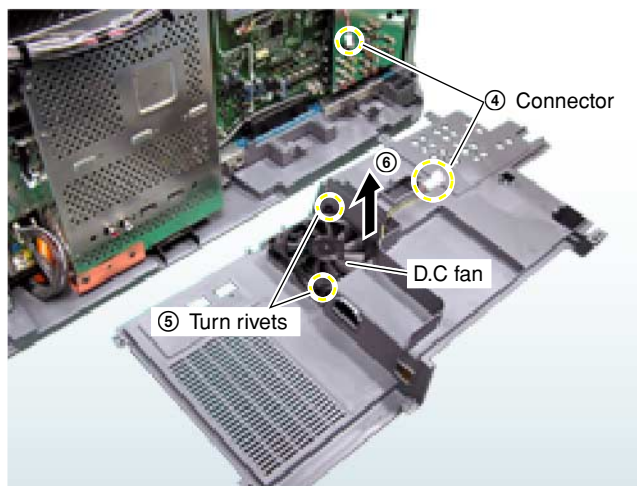
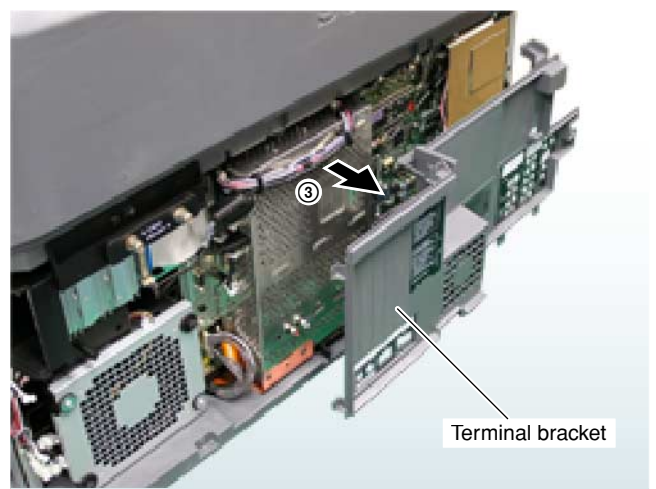
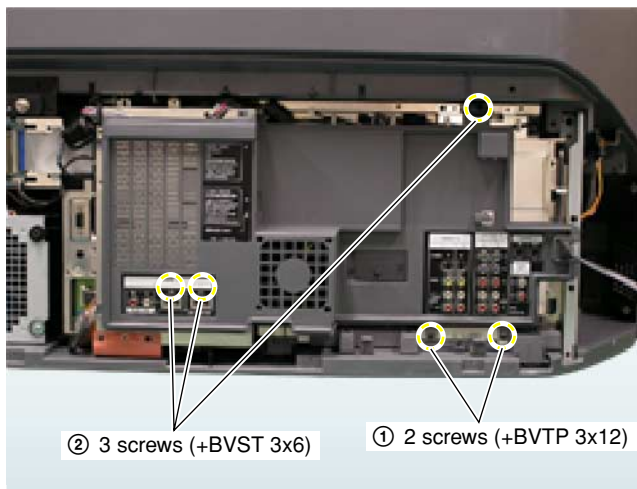

2-3. SERVICE POSITION

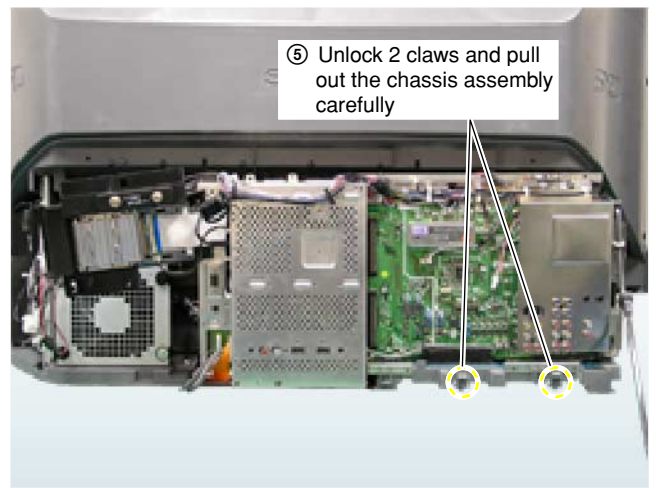
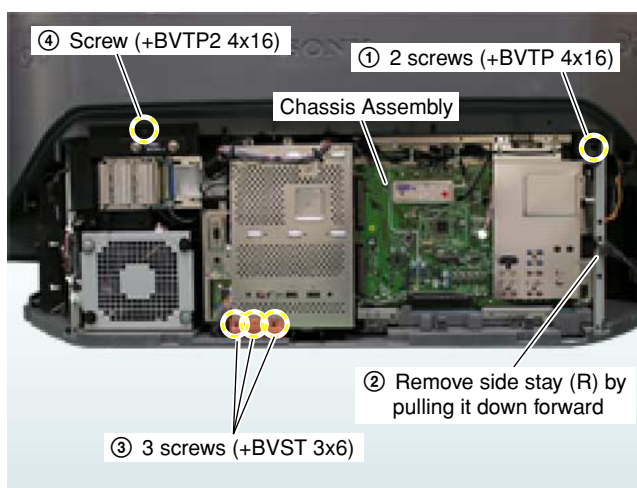

**2-4. POD BLOCK ASSEMBLY, ANTENNA SWITCH**

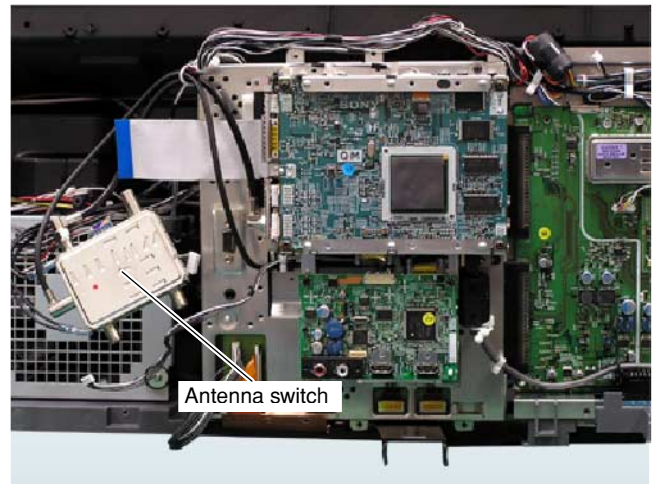
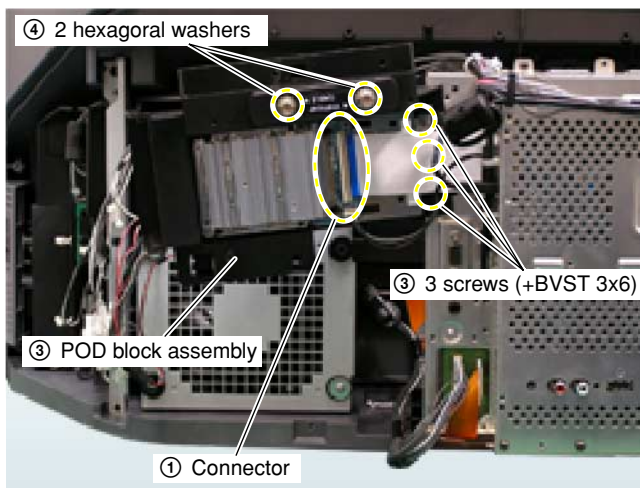

**2-5. DIGITAL BLOCK ASSEMBLY**

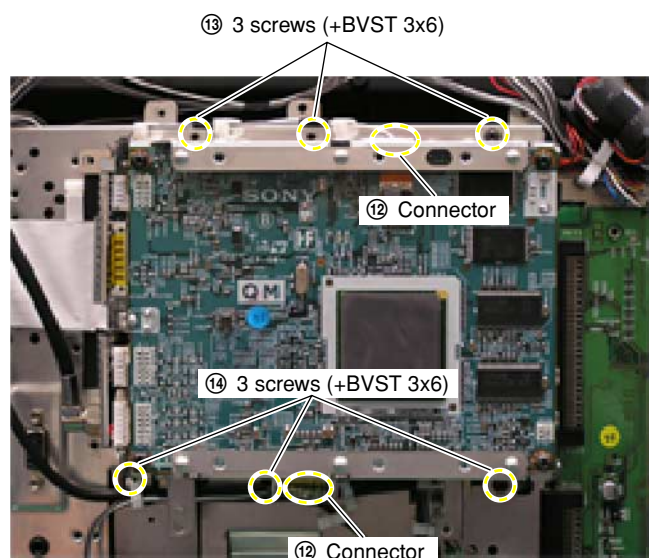
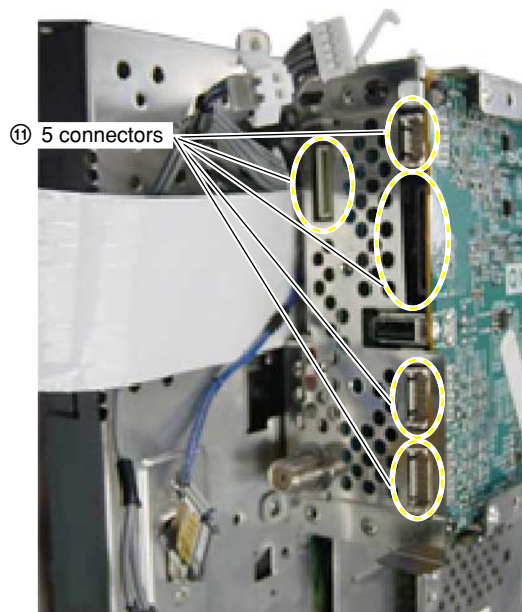
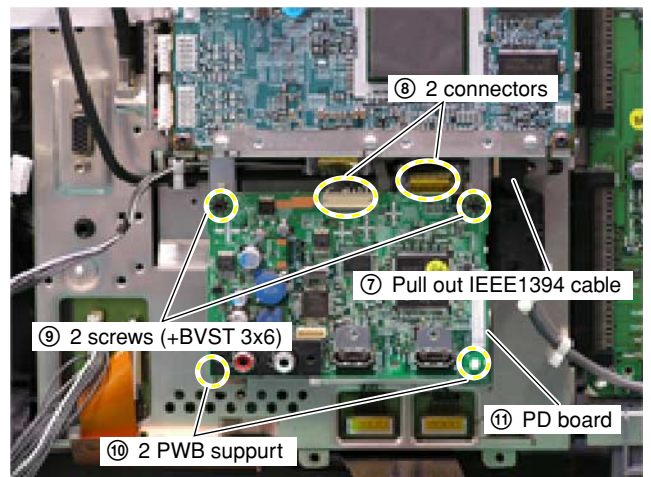
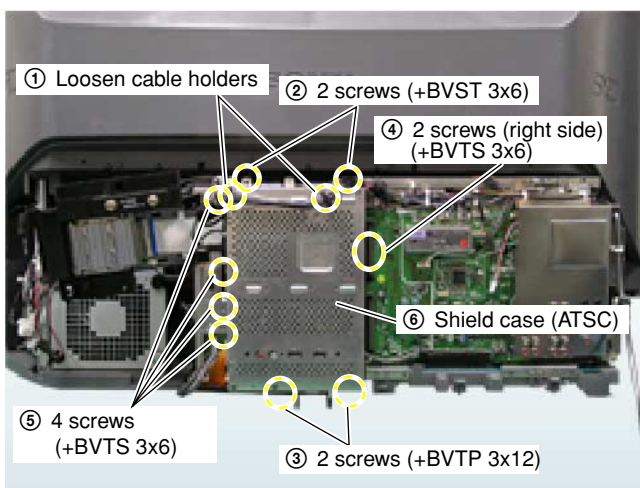

2-6. DC MOTOR SFF21C/C-NP

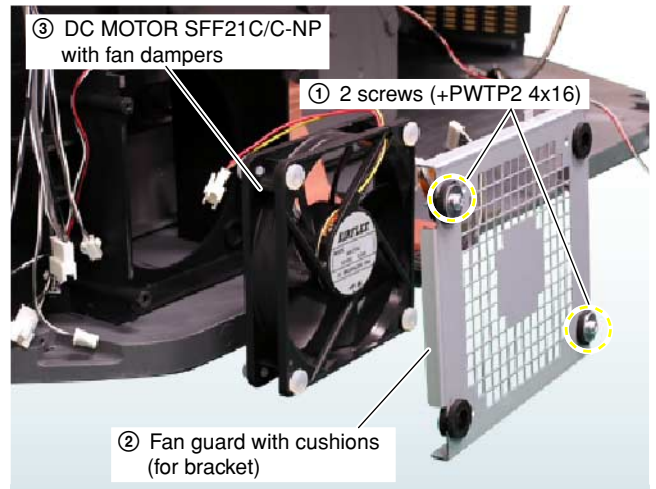
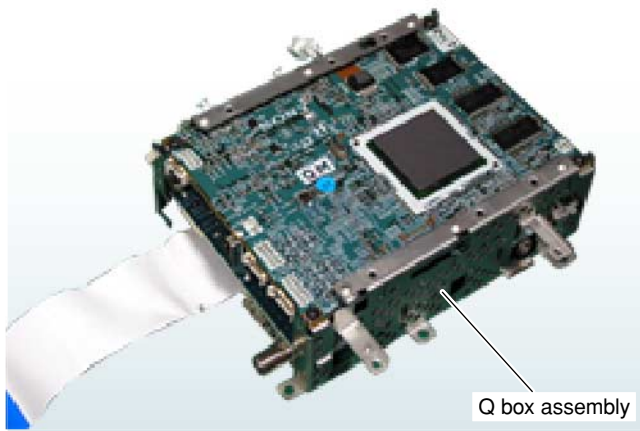

2-7. POWER SUPPLY BLOCK

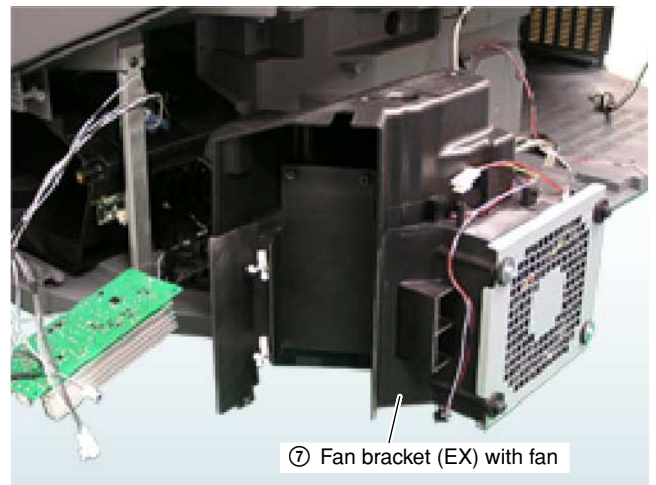
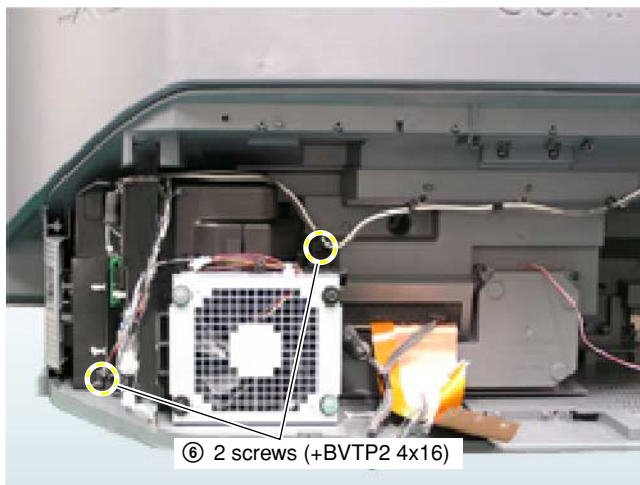
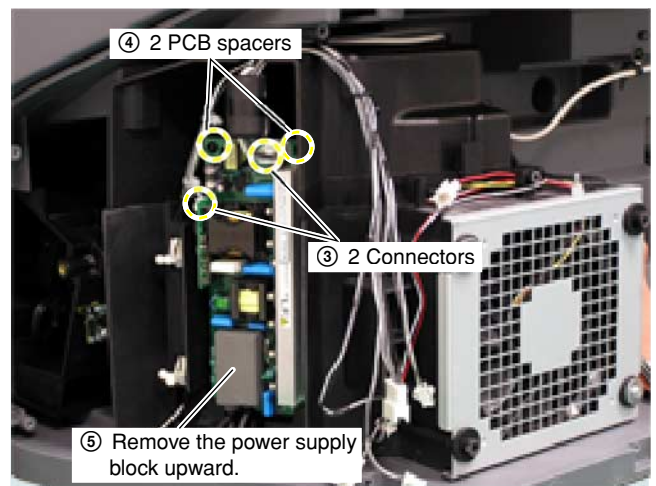
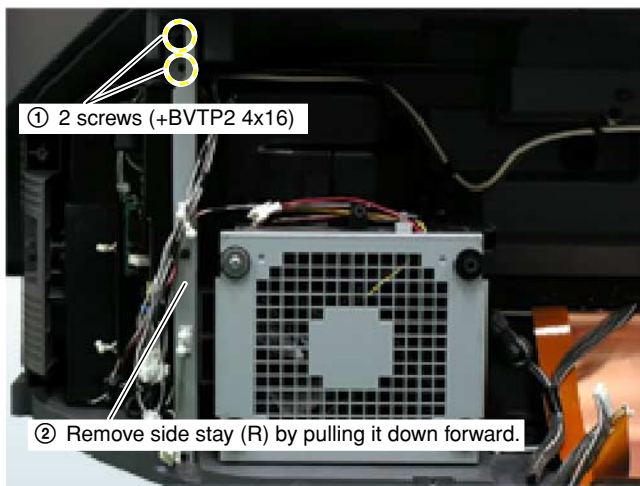

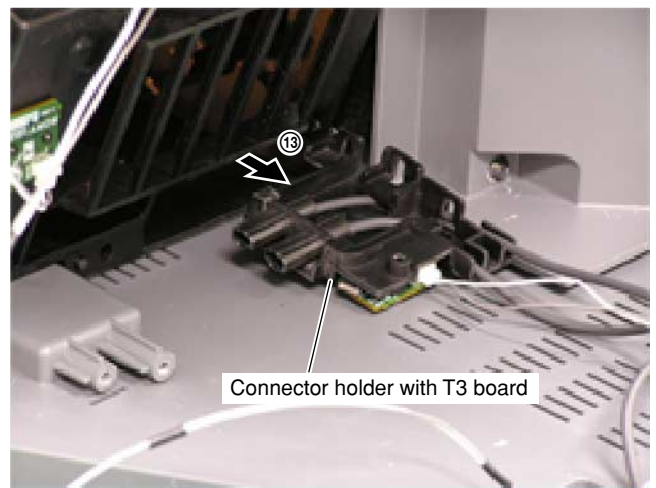
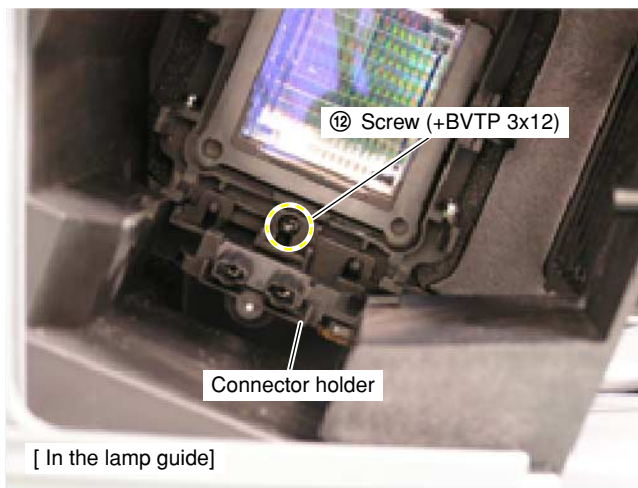
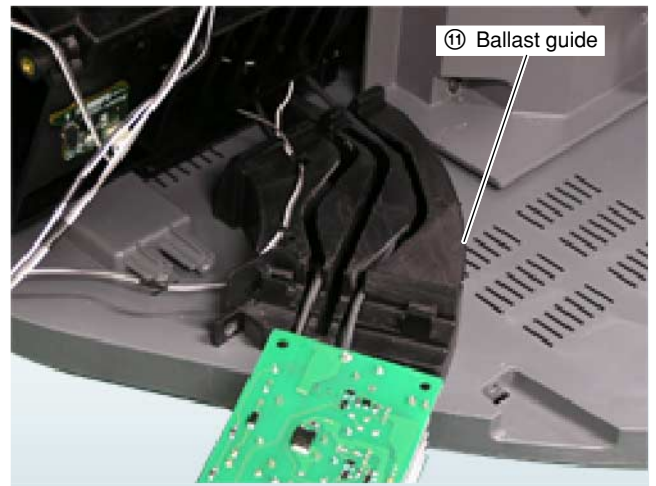
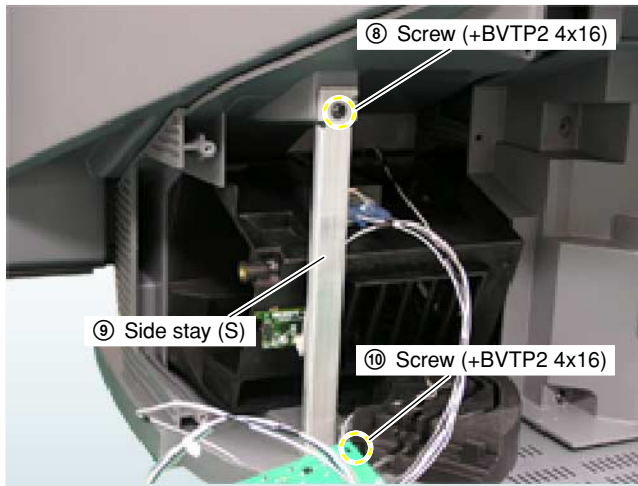

**2-8. UNIT COVER ASSEMBLY, LAMP (R) GUIDE ASSEMBLY**

**2-9. DC MOTOR SFF22A/C-NP**

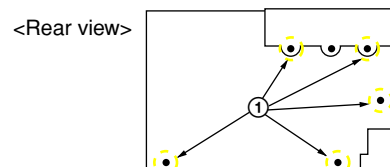
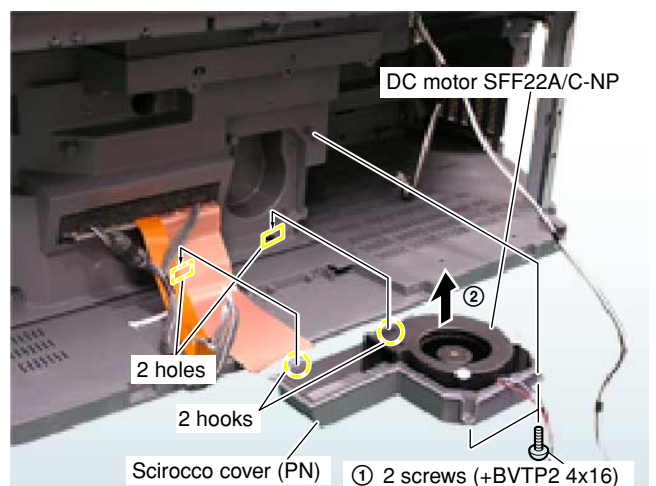
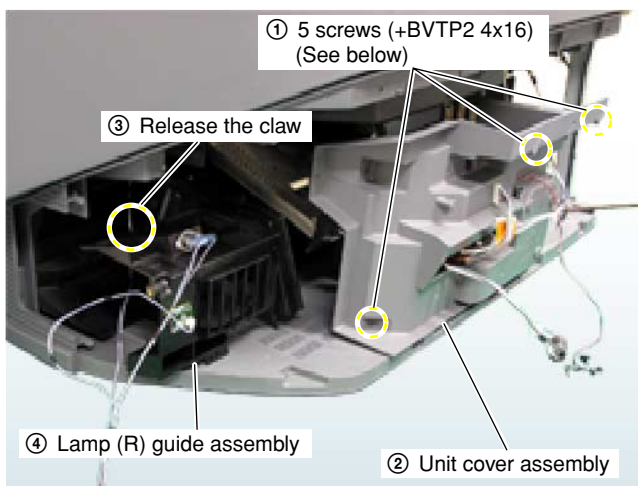

### 2-10. OPTICS BLOCK ASSEMBLY

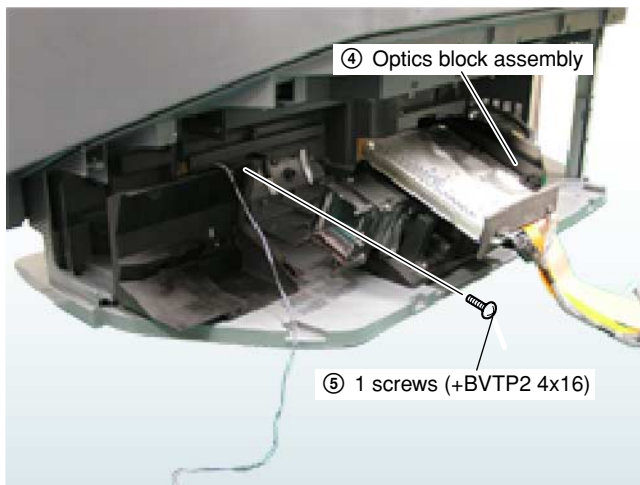
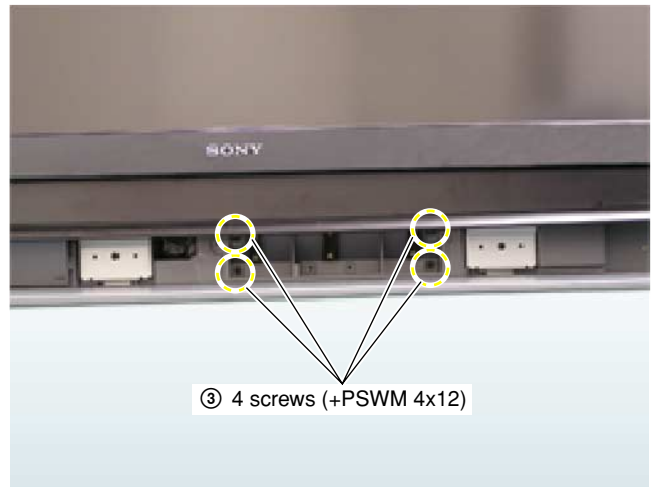
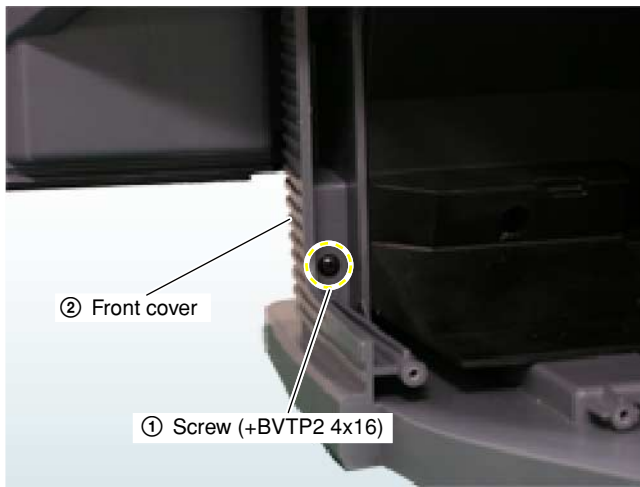

### 2-11. SCREEN FRAME BLOCK ASSEMBLY

Photo: R50XBR1

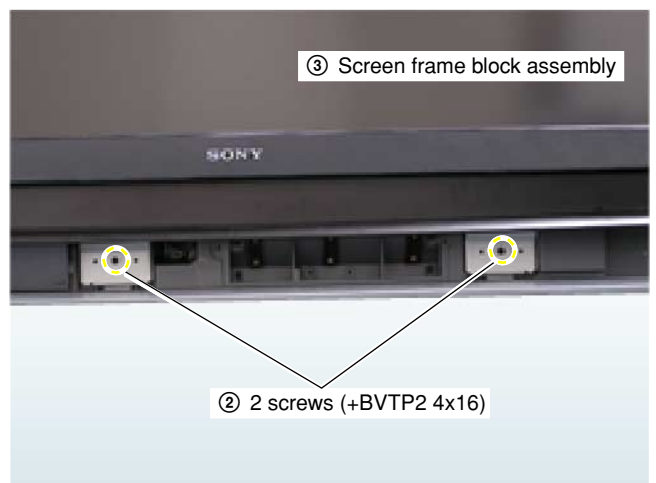
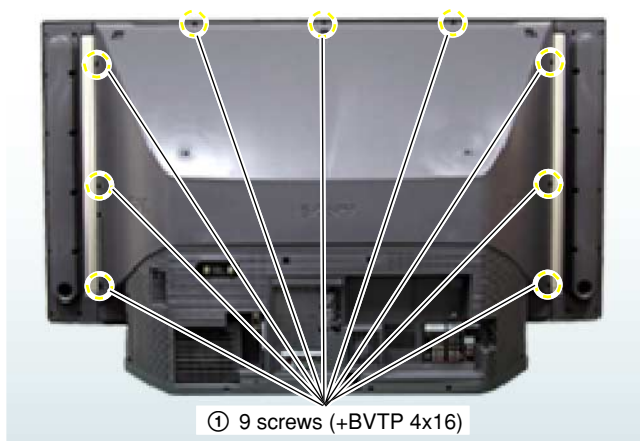

## 2-12. MIRROR COVER BLOCK ASSEMBLY

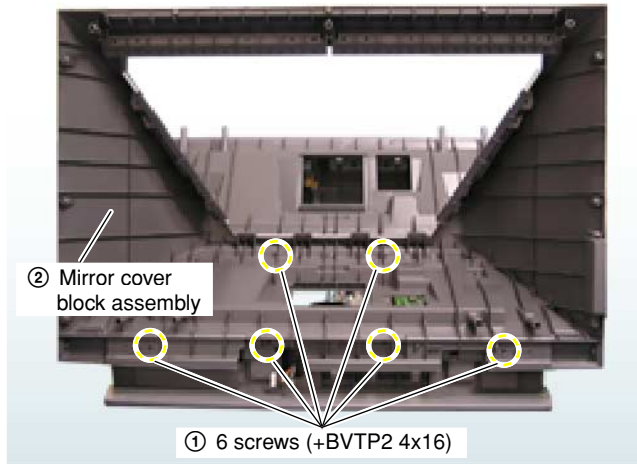

## 2-13. H1 BLOCK ASSEMBLY

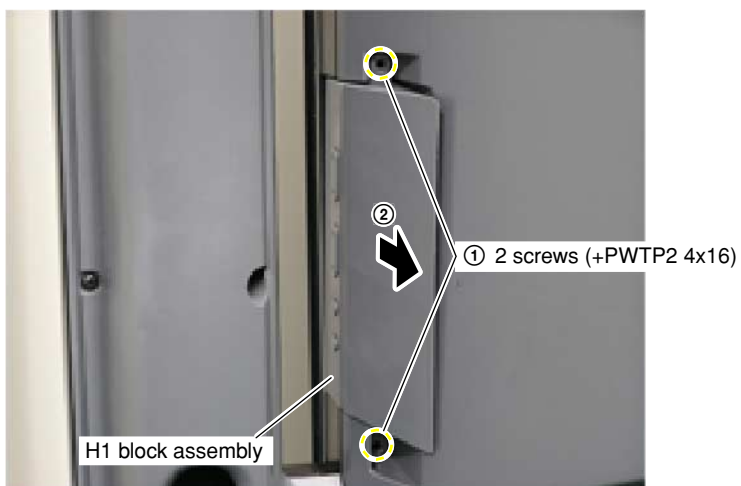

**SECTION 3**

**ELECTRICAL ADJUSTMENTS**

**3-1. ELECTRICAL ADJUSTMENT BY REMOTE COMMANDER**

By using remote commander (RM-Y914), all circuit adjustments can be made.

**NOTE : Test Equipment Required.**

1. Pattern Generator (with component outputs)
2. Oscilloscope
3. Digital multimeter

**3-1-2. Service Mode Adjustment**

1. The SCREEN displays the item being adjusted.
  2. Press “①” or “④” on the remote commander to select the adjustment item.
  3. Press “③” or “⑥” on the remote commander to change the data.
  4. Press “②” or “⑤” on the remote commander to select the category.
- Every time you press “②” (Category up), Service mode changes in the order as shown below.

**3-1-1. Method of Setting the Service Adjustment Mode**

1. Standby mode. (Power off)
2. **DISPLAY** → **5** → **VOL (+)** → **TV POWER** on the remote commander. (Press each button within a second.)  
The following service screen will appear.

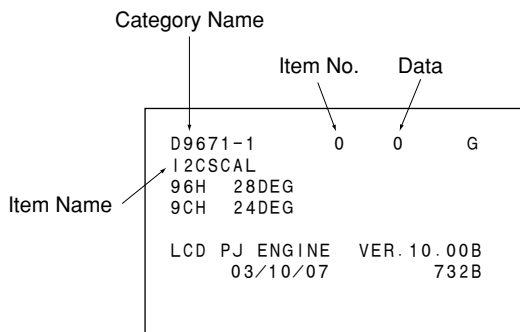
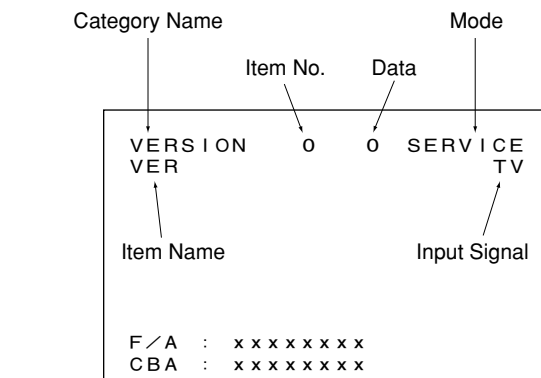

<LCD PROJECTOR ENGINE>

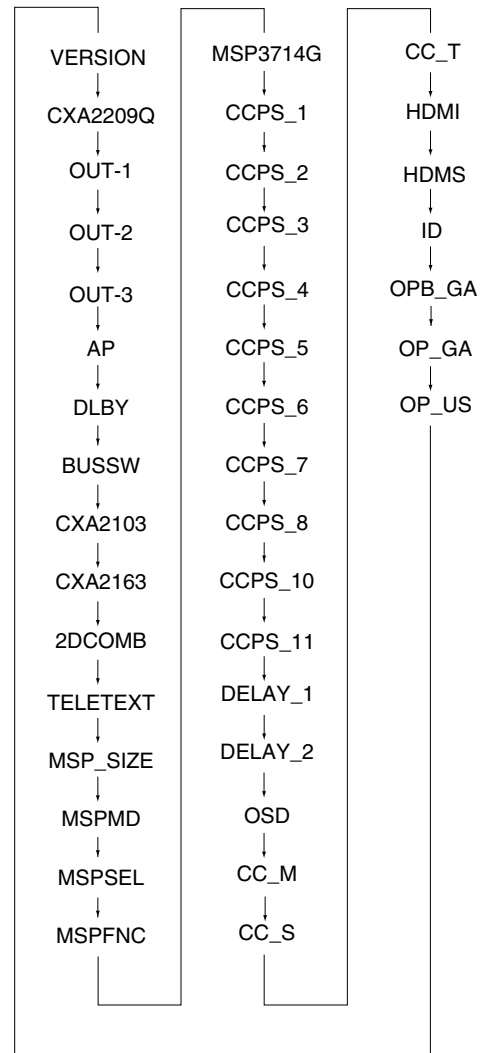

5. If you want to recover the latest values press “⑩” then “**ENTER**” to read the memory.
6. Press “**MUTING**” then “**ENTER**” to write into memory.
7. Turn power off.

<Method of setting the shipping condition>

1. Service Adjustment mode.
2. Press “⑧” then “**ENTER**”
3. Wait until appearing “ Initial Setup” display.
4. Disconnect AC plug and connect again to change factory reset condition completely.

**3-1-3. Memory Write Confirmation Method**

1. After adjustment, turn power off with the remote commander.
2. Turn power on and set to service mode.
3. Call the adjusted items again and confirm they were adjusted.



### 3-1-4. Adjusting Buttons and Indicator

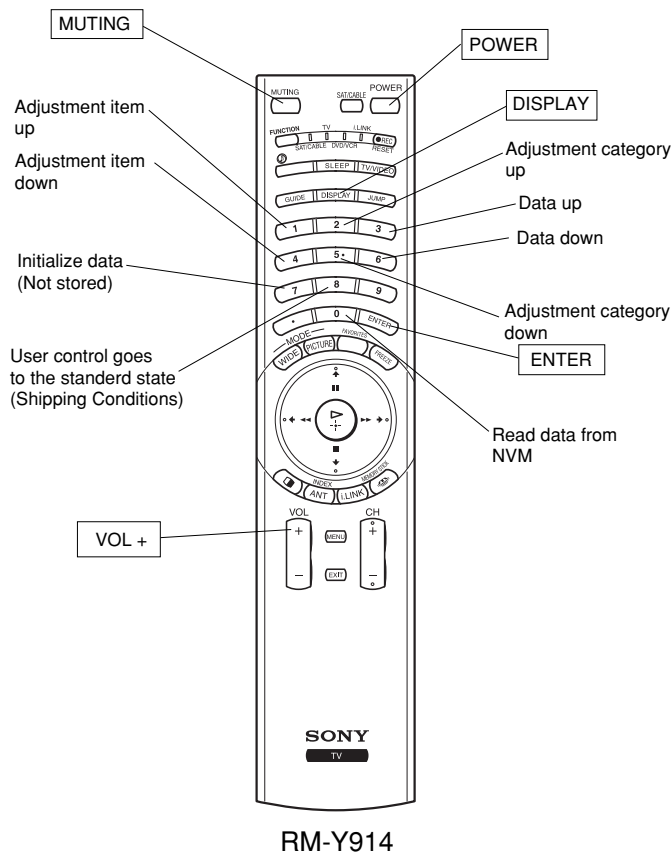

RM-Y914

#### FUNCTION OF KEYS ON COMMANDER

- ① : Changes adjustment item. (item No. moves up)
- ④ : Changes adjustment item. (item No. moves down)
- ② : Changes adjustment category. (category moves up)
- ⑤ : Changes adjustment category. (category moves down)
- ③ : Changes data value. (up)
- ⑥ : Changes data value. (down)

#### Commander Function

Button	Mode	Description
[MUTING] + [ENTER]	WRITE	Writes data to NVM.
① + [ENTER]	READ	Reads data from NVM.
⑧ + [ENTER]	RESET	Set the shipping condition.

### 3-2. To read Lamp and Panel time

The lamp and panel time of the set are displayed as follows .

#### <Enter the service mode>

1. Press the keys of the remote commander in rapid sequence as follows , when the set is in standby mode.

[DISPLAY] → Channel [5] → Vol [+ ] → [POWER]

2. Press the “JUMP ” key [3 times].  
You’ll get into DE-micro service menu .
3. Press “2 ” key [9 times] to show the following display .

Example

PANEL	NVM OK	9	OPTION_E
0	LAMP	0	Diff
LampTM	14	LampCT	71

This screen reads

“Total lamp time is 14 hours” and  
“Total lamp ON/OFF cycle is 71 times”

To reset lamp time,

press “3 ”, “MUTE ” and “ENTER ” keys in sequence.

WRI-EXE(Red Character) is momentarily displayed and LampTM will be reset to “0 ”.

4. Press “ 1 ” key [7 times].

Example

PANEL	NVM OK	9	OPTION_E
7	SH SFT1	10	Diff
PanelTM	14h		

This screen reads

“Total Panel time is 14 hours”

You can’t reset the Panel time with the Service menu .

#### <To get out of the Service menu>

The Service menu is cleared by turning off the set with a remote commander or the power switch .

### 3-3. Test Reset

The user settings can be reset to the factory default condition as follows.

1. Press “TEST “ and “RESET “ key in sequence when the set is ON .  
The LAMP,TIMER and POWER/STANDBY LED light and the picture is muted.  
After about 5 seconds the LAMP and TIMER LED go off, and the color of POWER/STANDBY LED changes from amber to green.  
After another 10 seconds the reset is completed and the initial set-up display appears.

### 3-4. H/V Center Confirmation and Adjustment

Please check the picture horizontal/vertical center after the replacement of the following parts .

- Optical block
- Top assembly

1. Check H/V center with 480i monoscope signal in “Full “ mode .
2. If the center is shifted , adjust it with the following service items .

Please record the steps shifted as  $\triangle$  DFD 16 and  $\triangle$  CXD9713 .

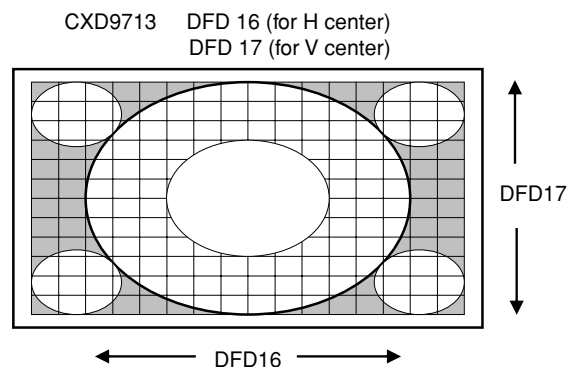

SECTION 4  
DIAGRAMS

4-1. BLOCK DIAGRAM (1)

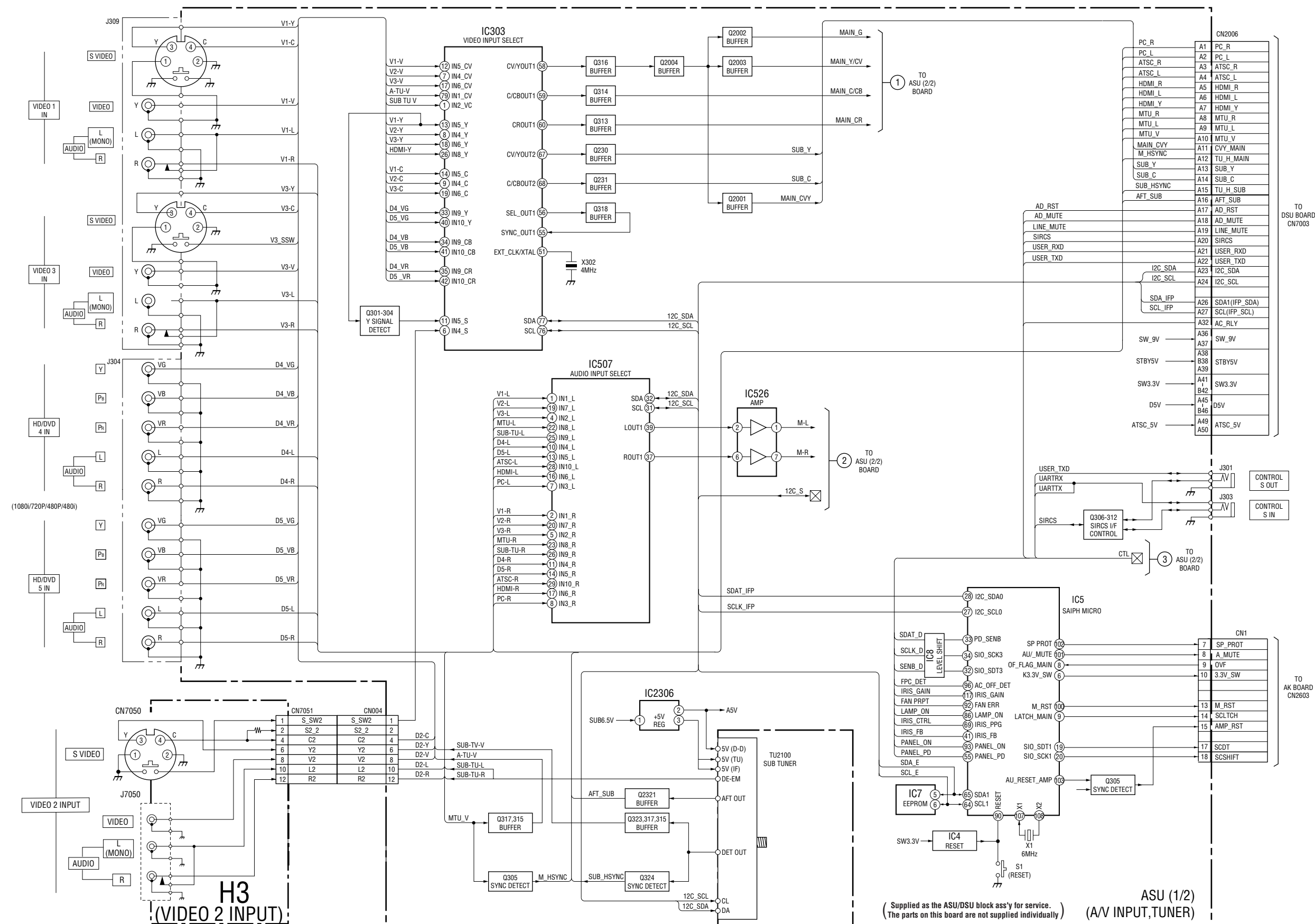

ASU (1/2)  
(A/V INPUT, TUNER)

(Supplied as the ASU/DSU block ass'y for service.  
The parts on this board are not supplied individually)





BLOCK DIAGRAM (4)

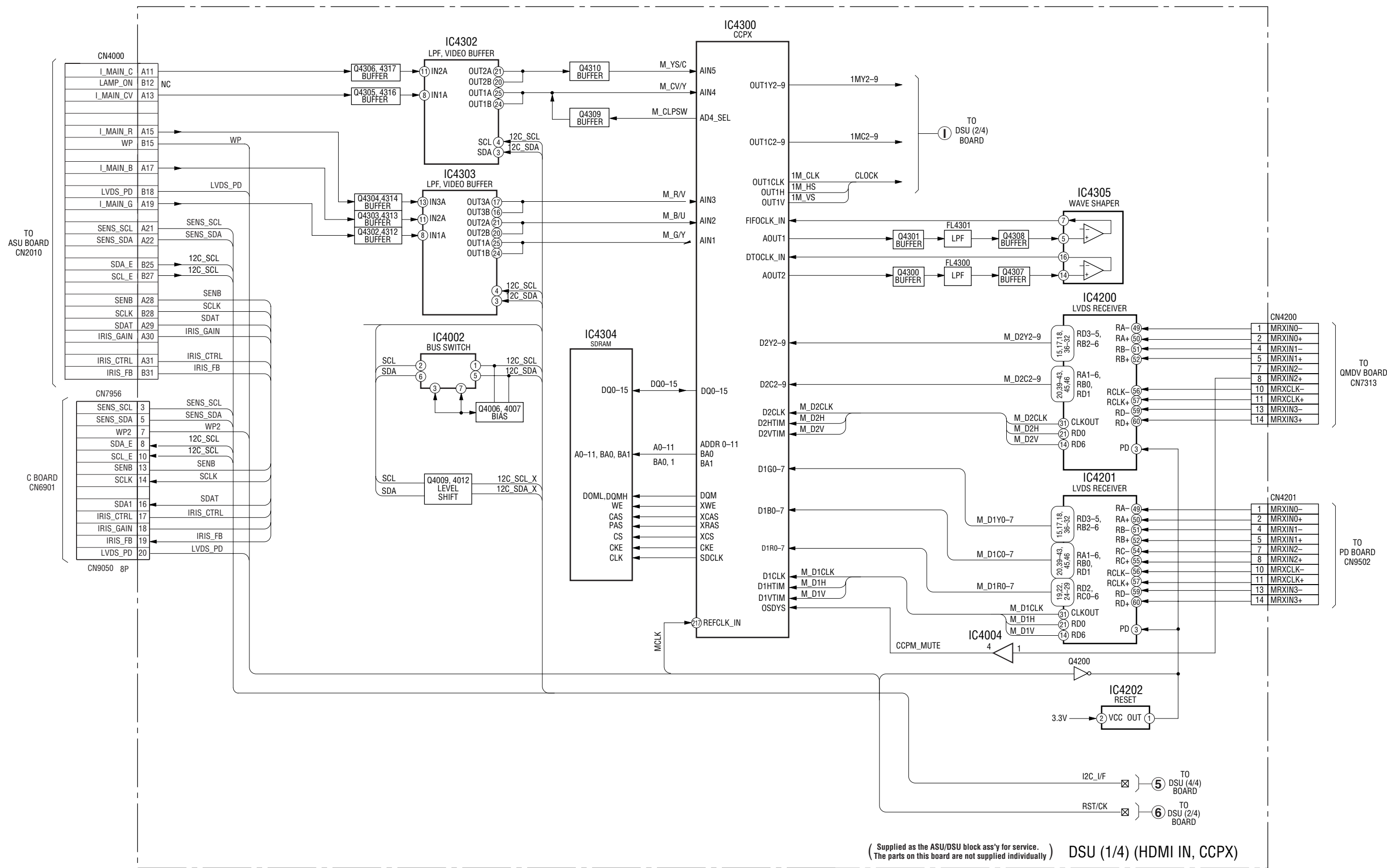

BLOCK DIAGRAM (5)

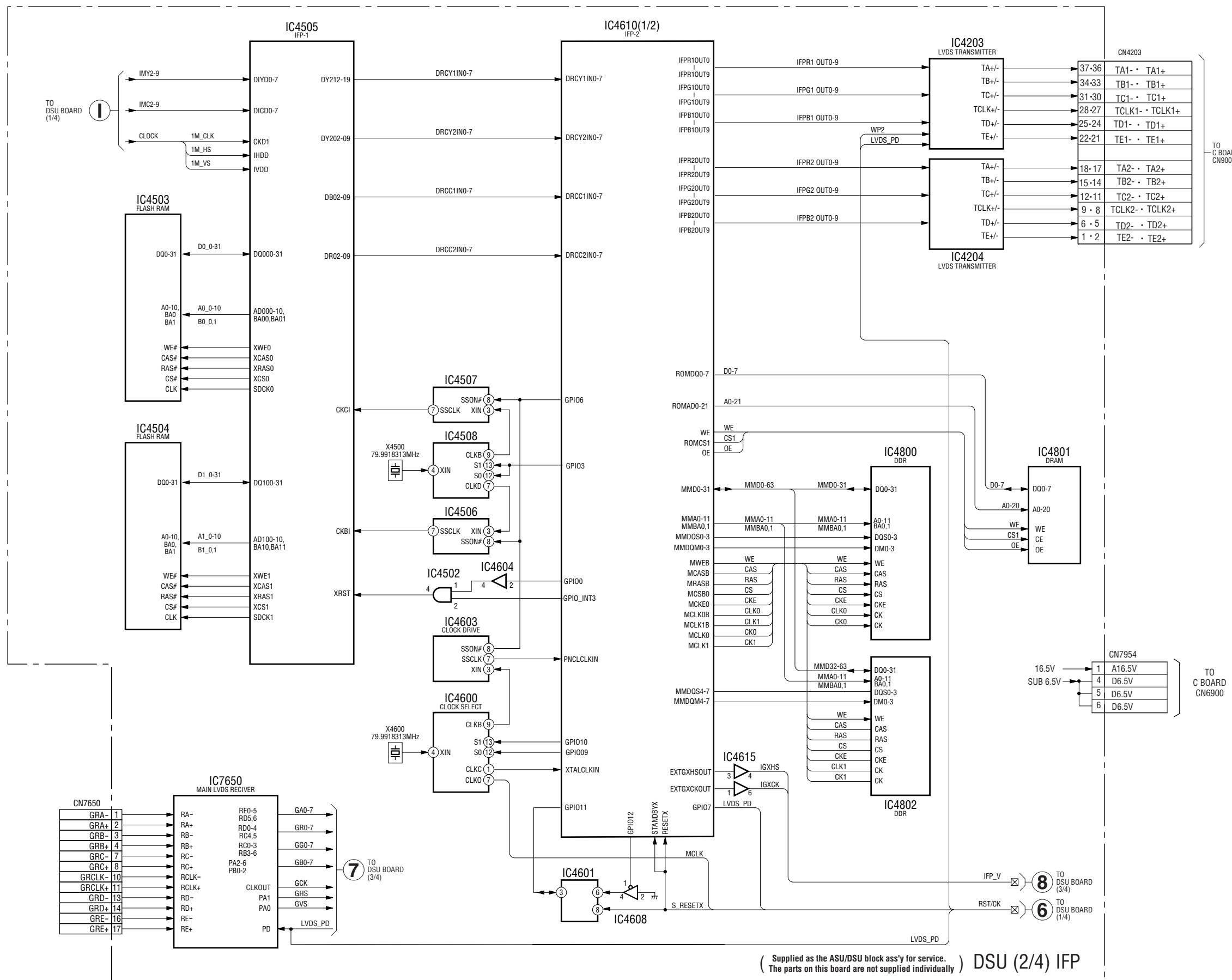

( Supplied as the ASU/DSU block ass'y for service. ) DSU (2/4) IFP  
The parts on this board are not supplied individually

BLOCK DIAGRAM (6)

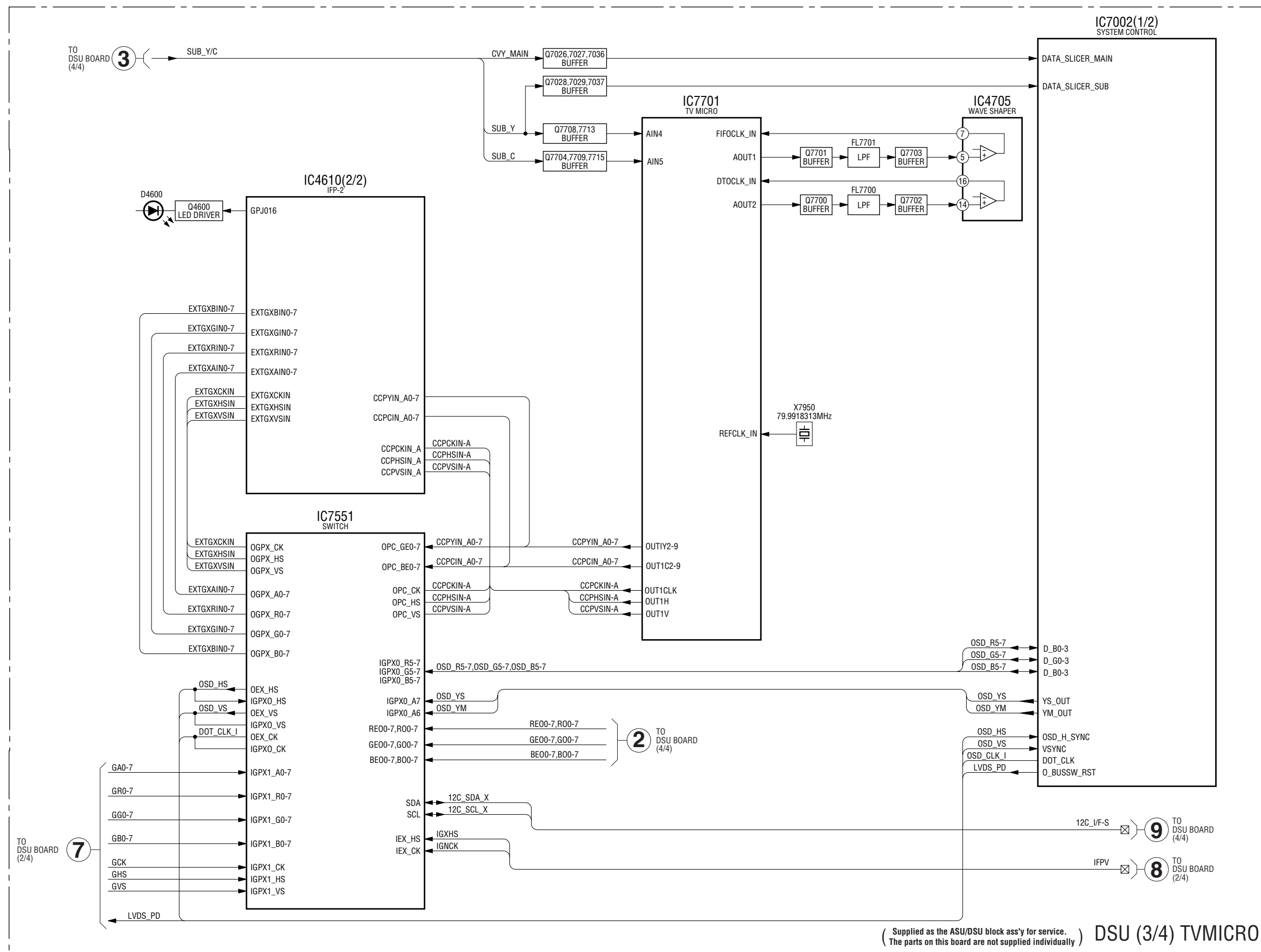

**BLOCK DIAGRAM (7)**

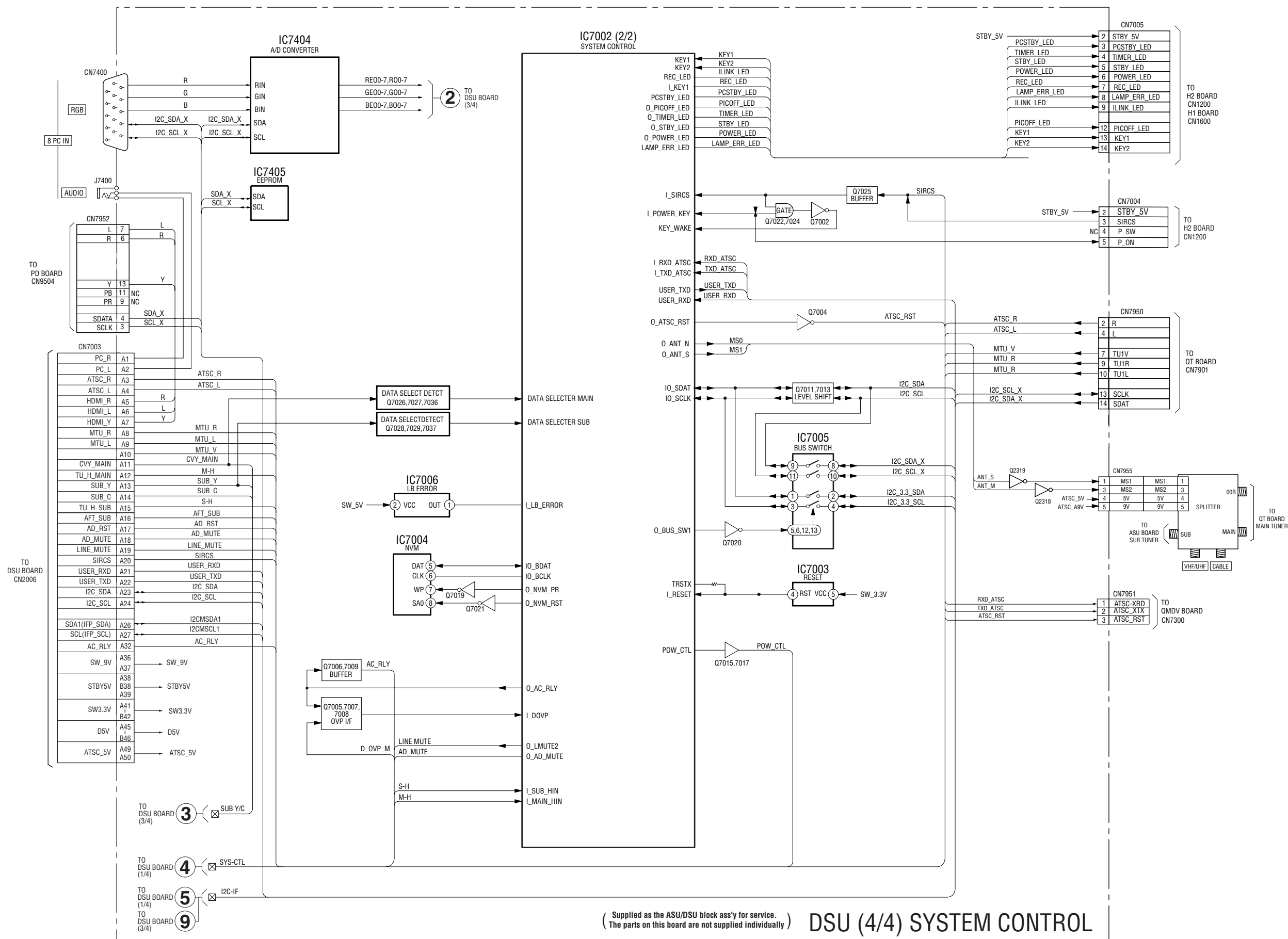



BLOCK DIAGRAM (8)

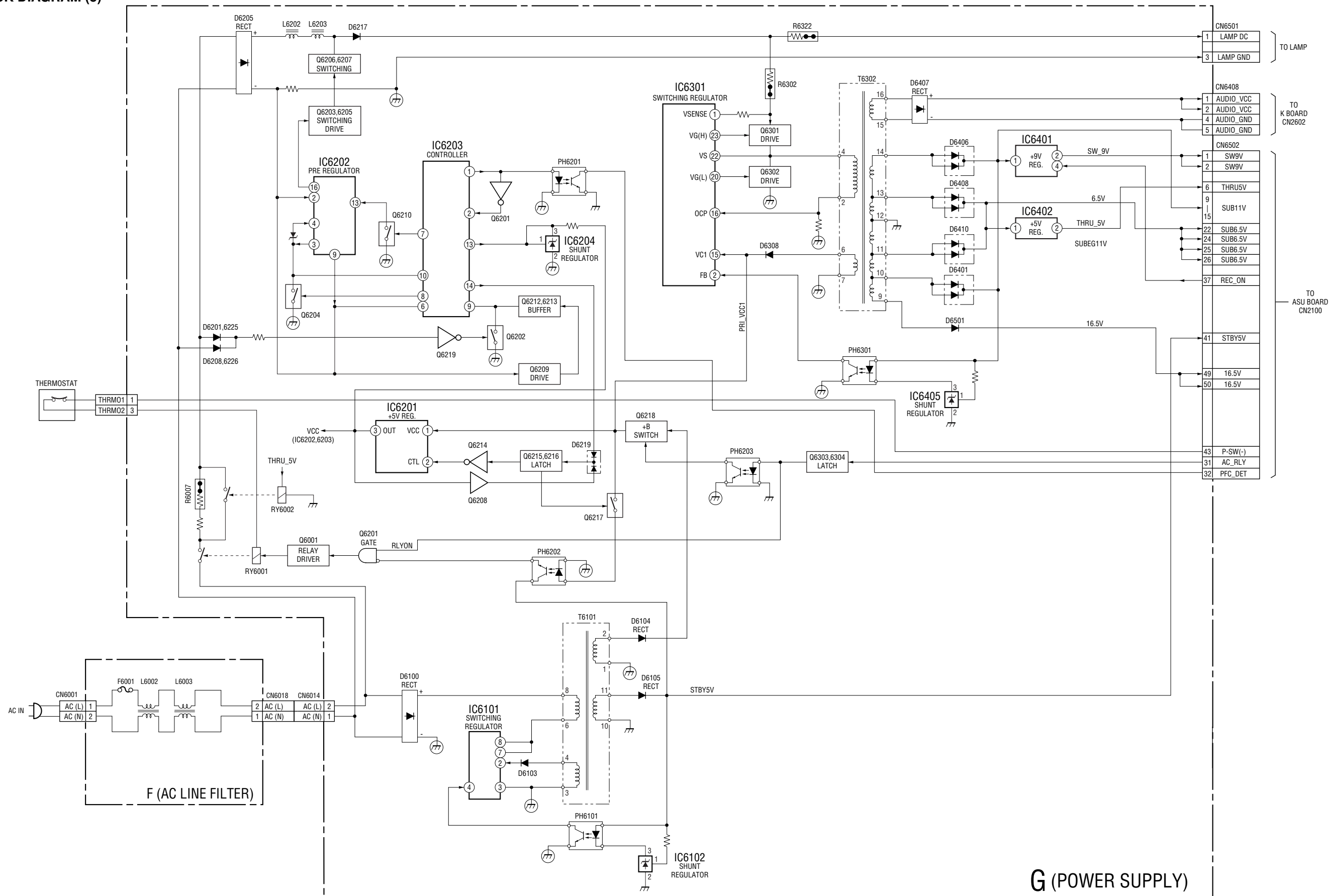

G (POWER SUPPLY)

BLOCK DIAGRAM (9)

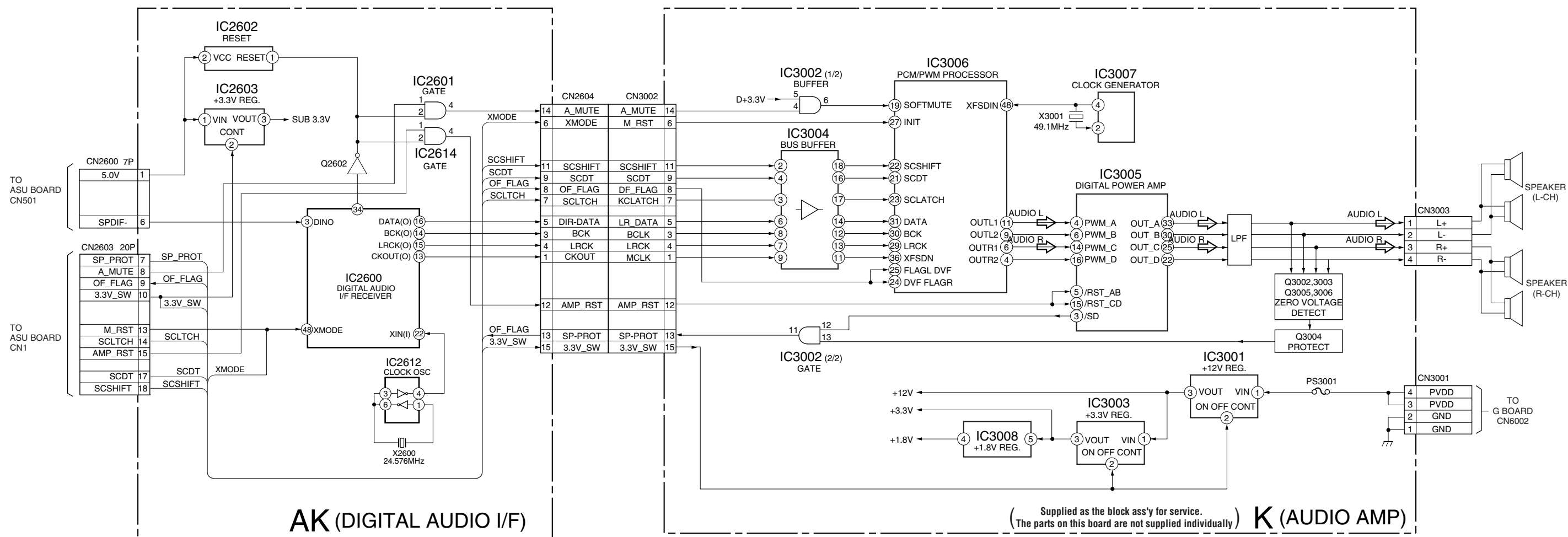

BLOCK DIAGRAM (10)

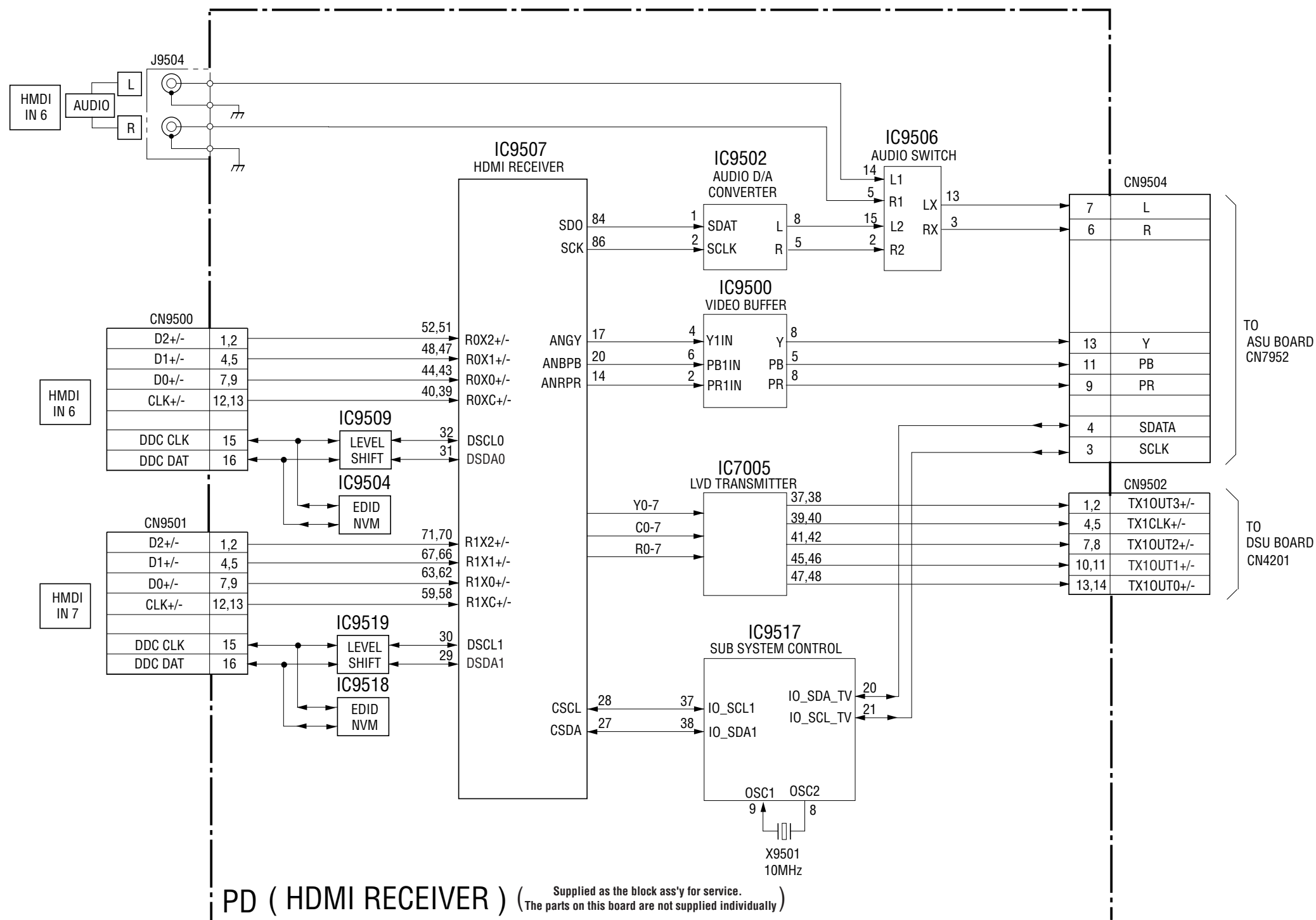

BLOCK DIAGRAM (11)

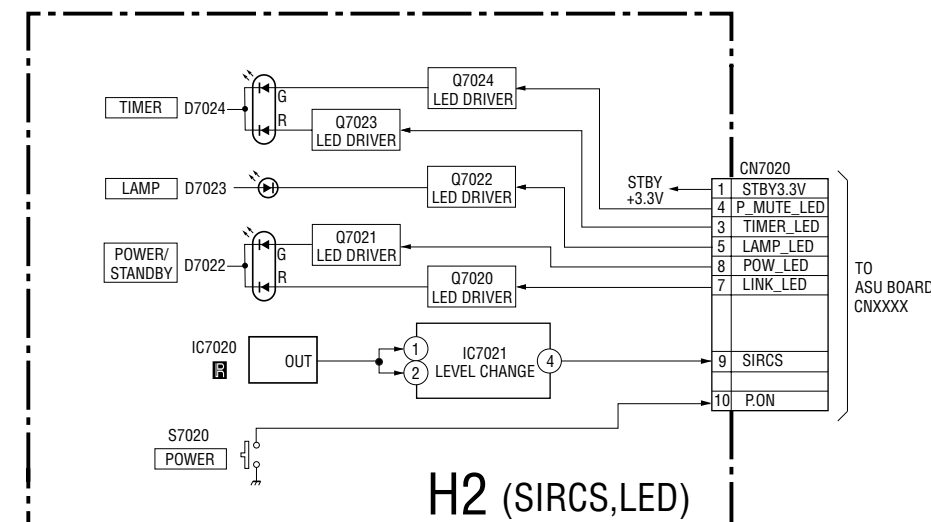
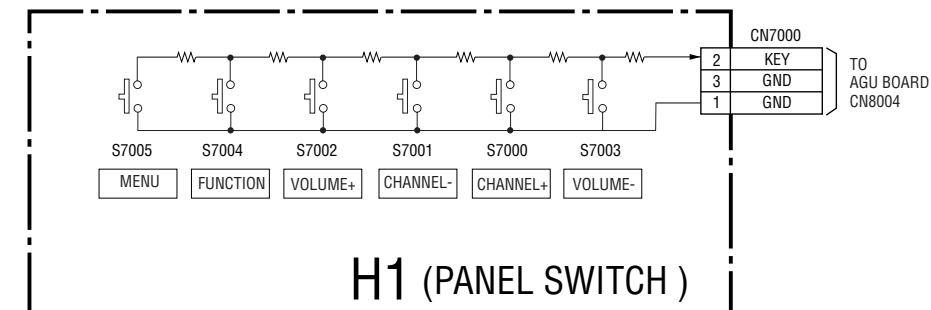
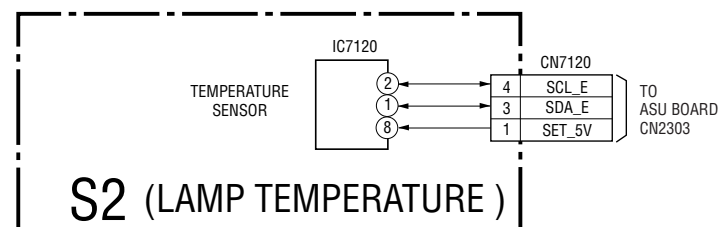
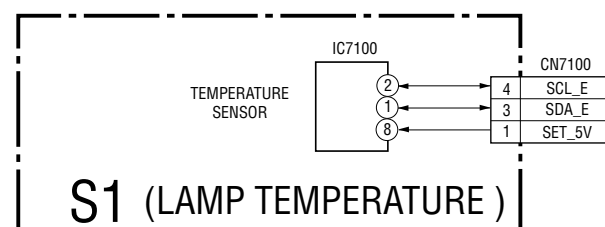
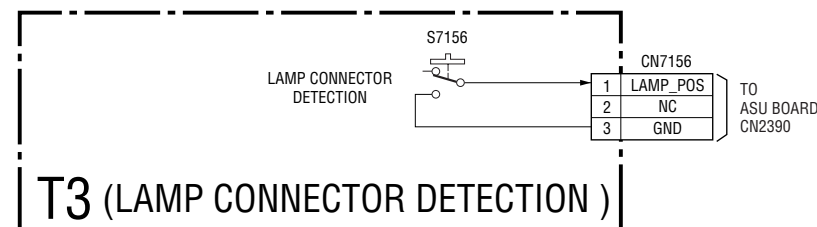
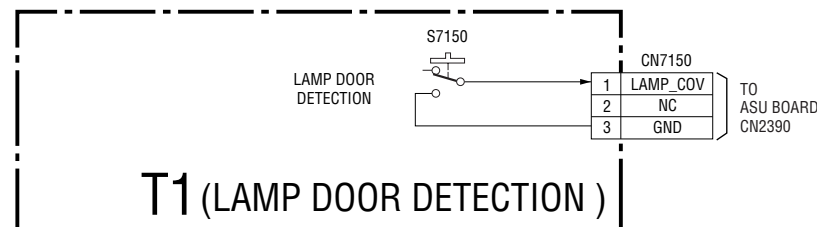
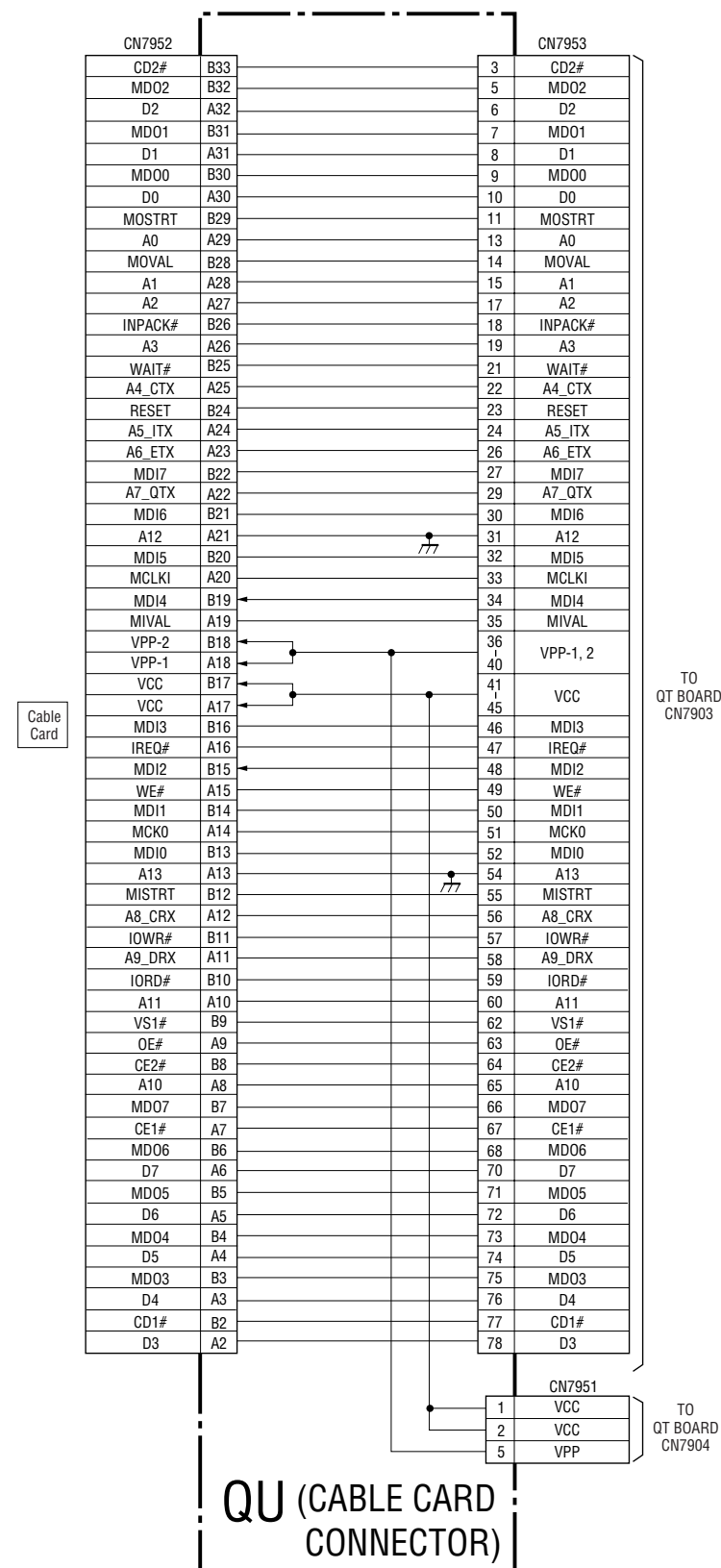

BLOCK DIAGRAM (12)

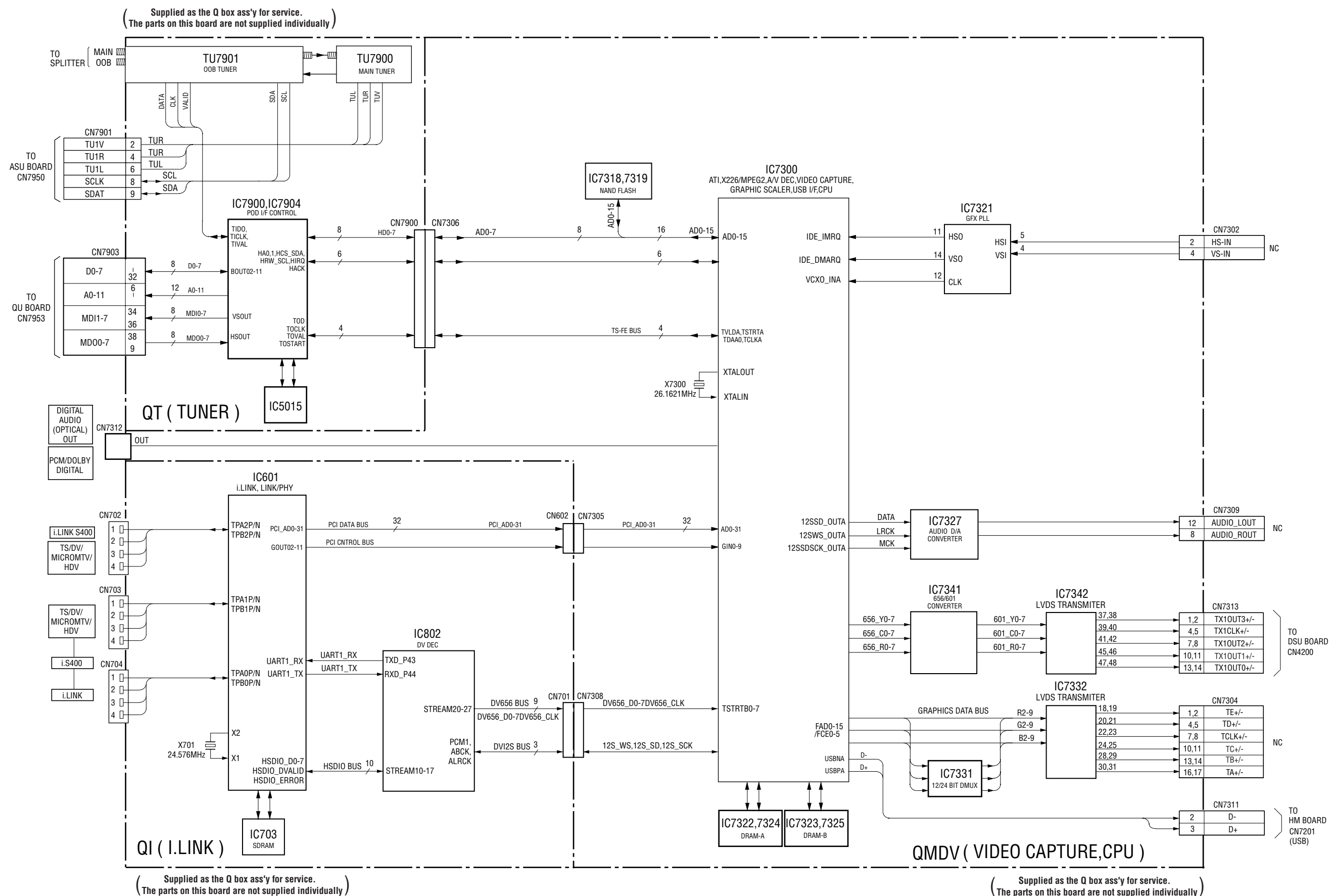

4-2. FRAME SCHEMATIC DIAGRAM

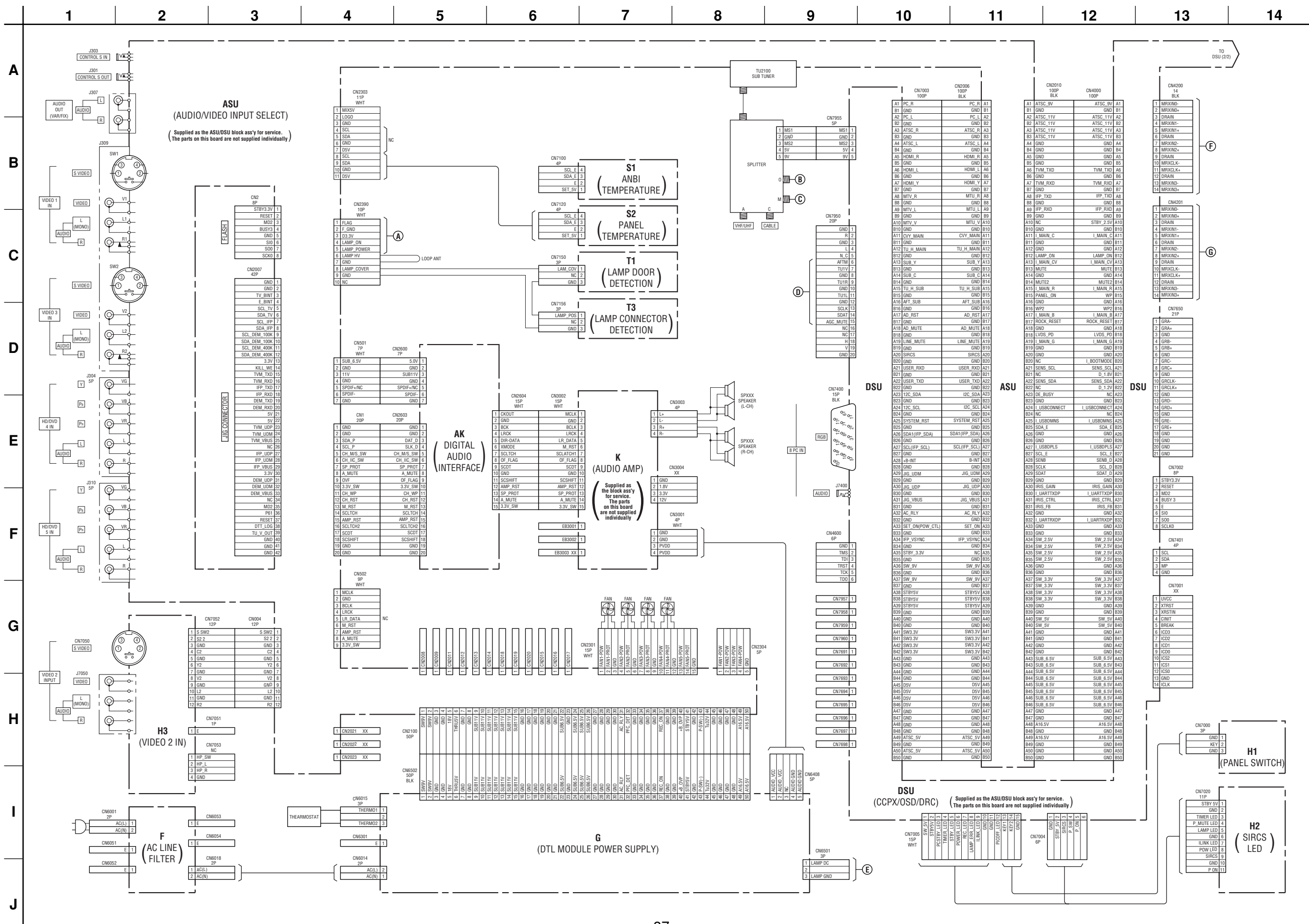



### 4-3. CIRCUIT BOARDS LOCATION

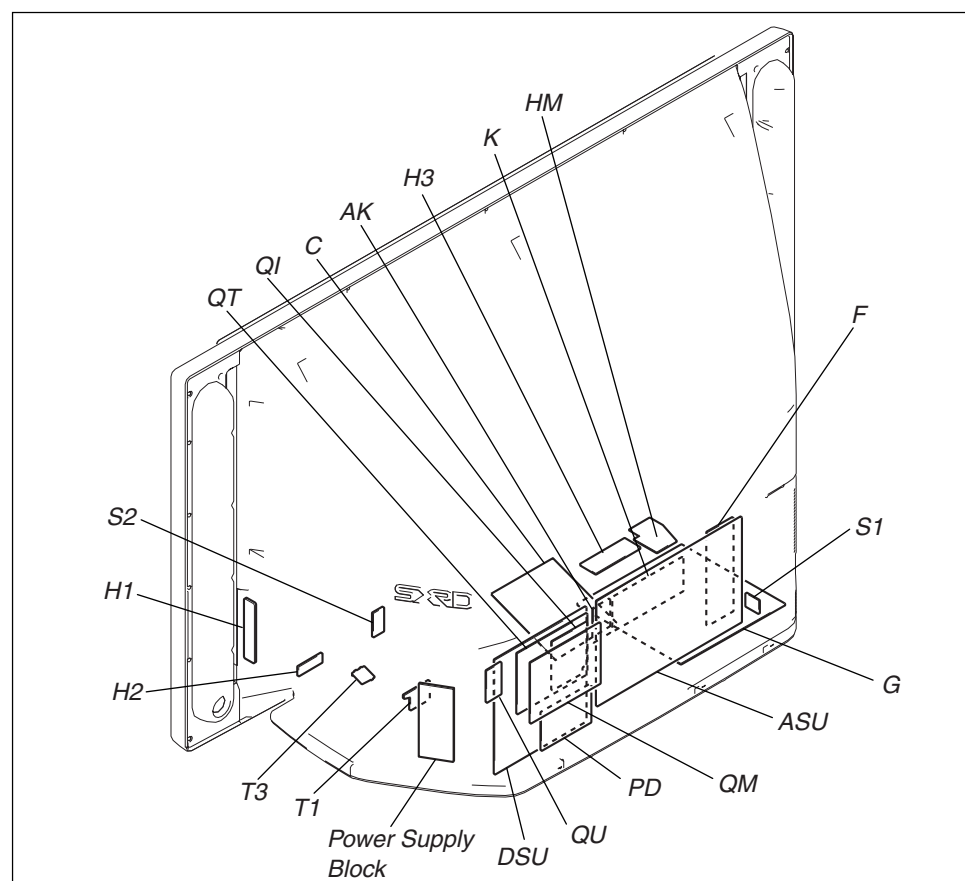

### 4-4. SCHEMATIC DIAGRAMS

**Note:**

- The parts marked "#" on schematic diagrams are not mounted.
- All capacitors are in  $\mu\text{F}$  unless otherwise noted. (pF:  $\mu\text{pF}$ ) Capacitors without voltage indication are all 50 V.
- Indication of resistance, which does not have one for rating electrical power, is as follows.

Pitch: 5 mm  
Rating electrical power 1/4 W (CHIP : 1/10 W)

- All resistors are in ohms.
- : nonflammable resistor.
- : fusible resistor.
- $\Delta$  : internal component.
- : panel designation, and adjustment for repair.
- All variable and adjustable resistors have characteristic curve B, unless otherwise noted.
- $\perp$  : earth-ground.
- : earth-chassis.
- All voltages are in V.
- Readings are taken with a 10 M $\Omega$  digital multimeter.
- Readings are taken with a color-bar signal input.
- Voltage variations may be noted due to normal production tolerances.
- \* : Can not be measured.
- Circled numbers are waveform references.
- : B + bus.
- : B - bus.
- : Signal path.

**Reference information**

RESISTOR	: RN	METAL FILM
	: RC	SOLID
	: FPRD	NONFLAMMABLE CARBON
	: FUSE	NONFLAMMABLE FUSIBLE
	: RW	NONFLAMMABLE WIREWOUND
	: RS	NONFLAMMABLE METAL OXIDE
	: RB	NONFLAMMABLE CEMENT
COIL	: LF-8L	MICRO INDUCTOR
CAPACITOR	: TA	TANTALUM
	: PS	STYROL
	: PP	POLYPROPYLENE
	: PT	MYLAR
	: MPS	METALIZED POLYESTER
	: MPP	METALIZED POLYPROPYLENE
	: ALB	BIPOLAR
	: ALT	HIGH TEMPERATURE
	: ALR	HIGH RIPPLE

**Note: The components identified by shading and mark  $\Delta$  are critical for safety. Replace only with part number specified.**

**Note: Les composants identifiés par une trame et une marque  $\Delta$  sont critiques pour la securite. Ne les remplacer que par une piece portant le numero specifie.**

### Terminal name of semiconductors in silk screen printed circuit (\*)

Device	Printed symbol	Terminal name	Circuit
① Transistor		Collector Base Emitter	
② Transistor		Collector Base Emitter	
③ Diode		Cathode Anode	
④ Diode		Cathode Anode (NC)	
⑤ Diode		Cathode Anode (NC)	
⑥ Diode		Common Anode Cathode	
⑦ Diode		Common Anode Cathode	
⑧ Diode		Common Anode Anode	
⑨ Diode		Common Anode Anode	
⑩ Diode		Common Cathode Cathode	
⑪ Diode		Common Cathode Cathode	
⑫ Diode		Anode Cathode Anode Cathode	
⑬ Transistor (FET)		Drain Source Gate	
⑭ Transistor (FET)		Drain Source Gate	
⑮ Transistor (FET)		Source Drain Gate	
⑯ Transistor		Emitter Collector Base	
⑰ Transistor		C2 B1 E1 E2 B2 C1	
⑱ Transistor		C1 B2 E2 E1 B1 C2	
⑲ Transistor		C1 B2 E2 E1 B1 C2	
⑳ Transistor		C1 B2 E2 E1 B1 C2	
㉑ Transistor		E2 B1 E1 C2 C1(B2)	
㉒ Transistor		(B2) B1 E1 E2 C1 C2	
㉓ Transistor		(B2) E2 E1 B1 C2 C1	

(Chip semiconductors that are not actually used are included.)

Ver.1.5





(2) Schematic Diagram of F Board

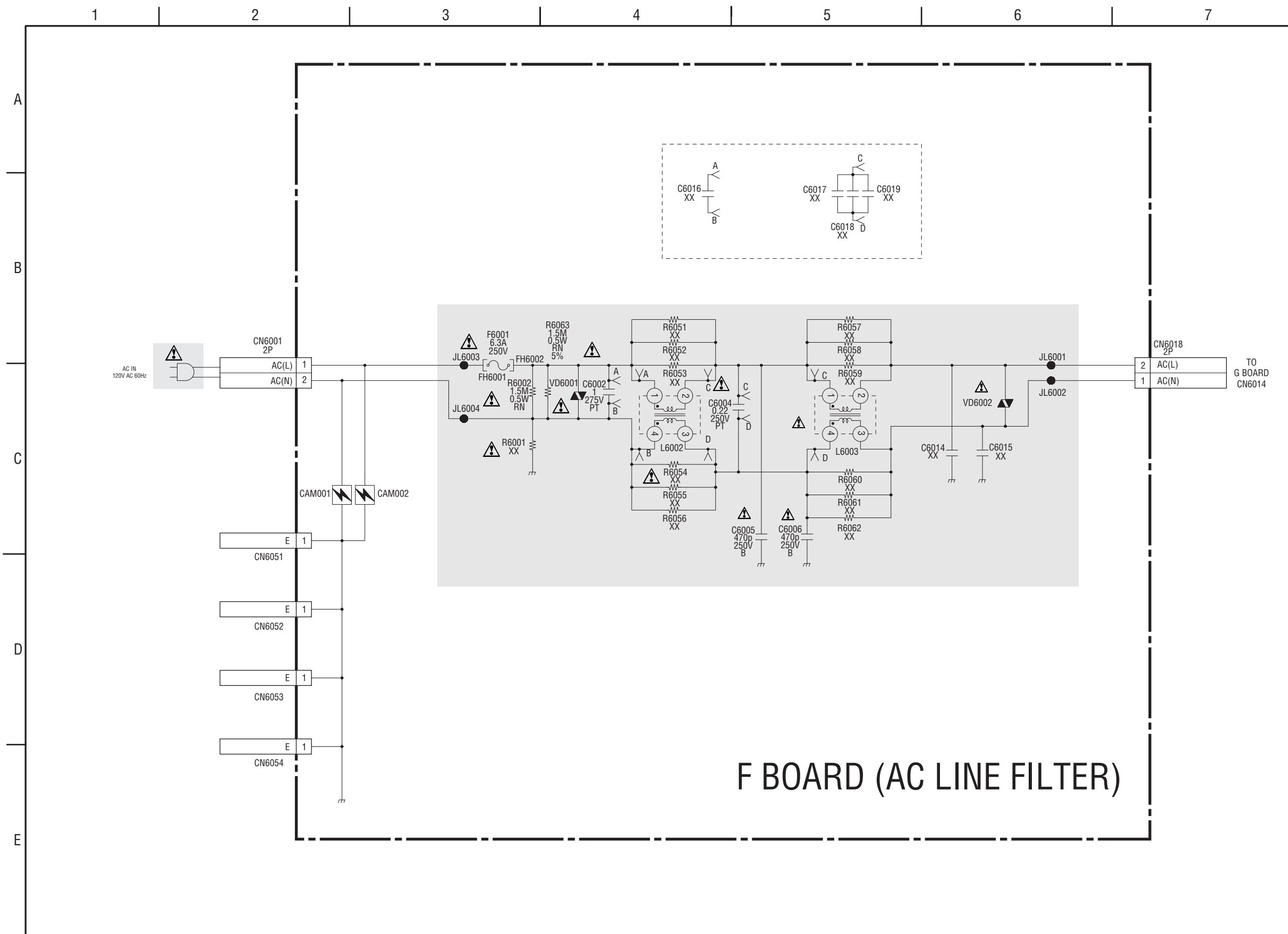

F BOARD (AC LINE FILTER)

(3) Schematic Diagram of G (1/3) Board

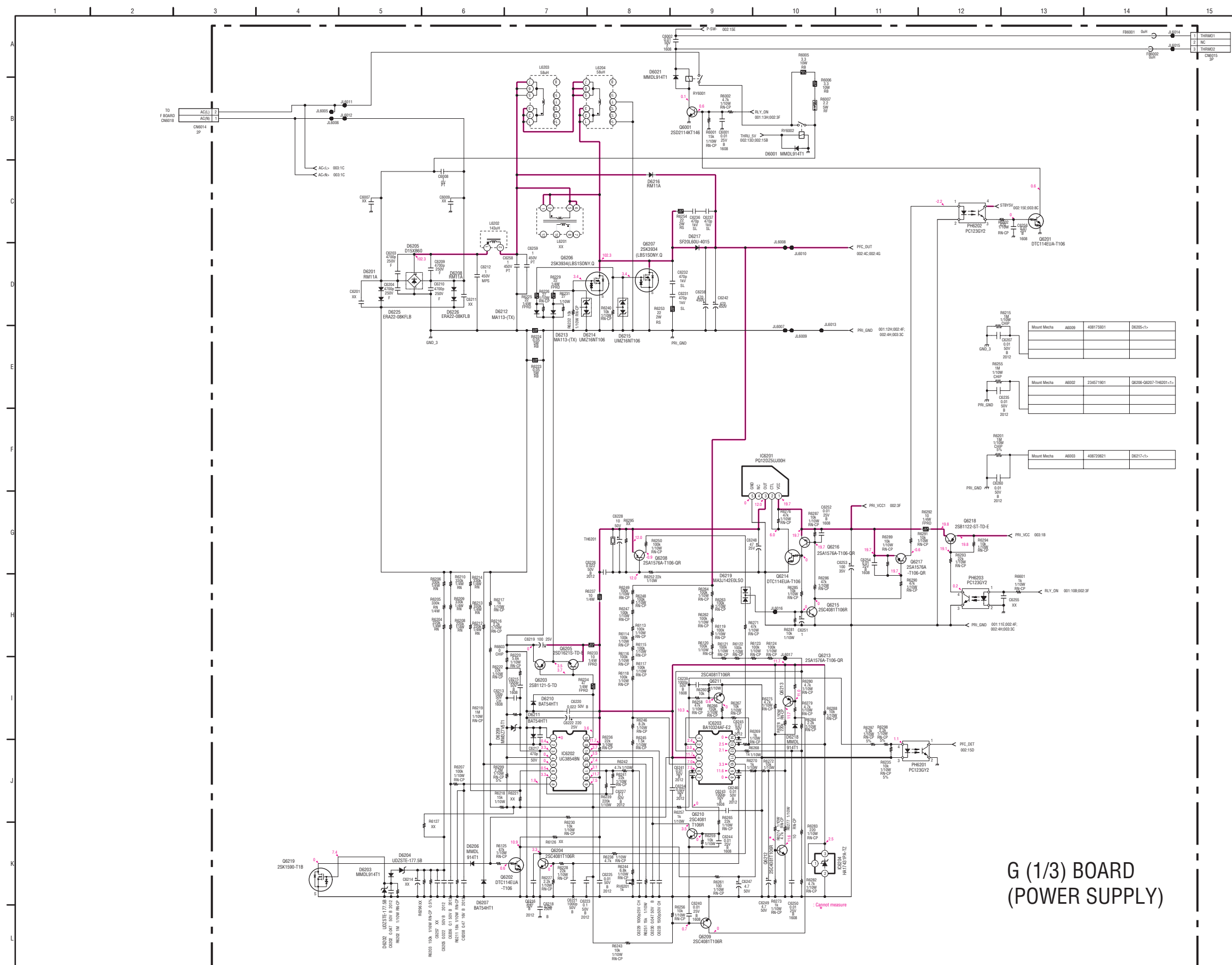

G (1/3) BOARD  
(POWER SUPPLY)

(4) Schematic Diagram of G (2/3) Board

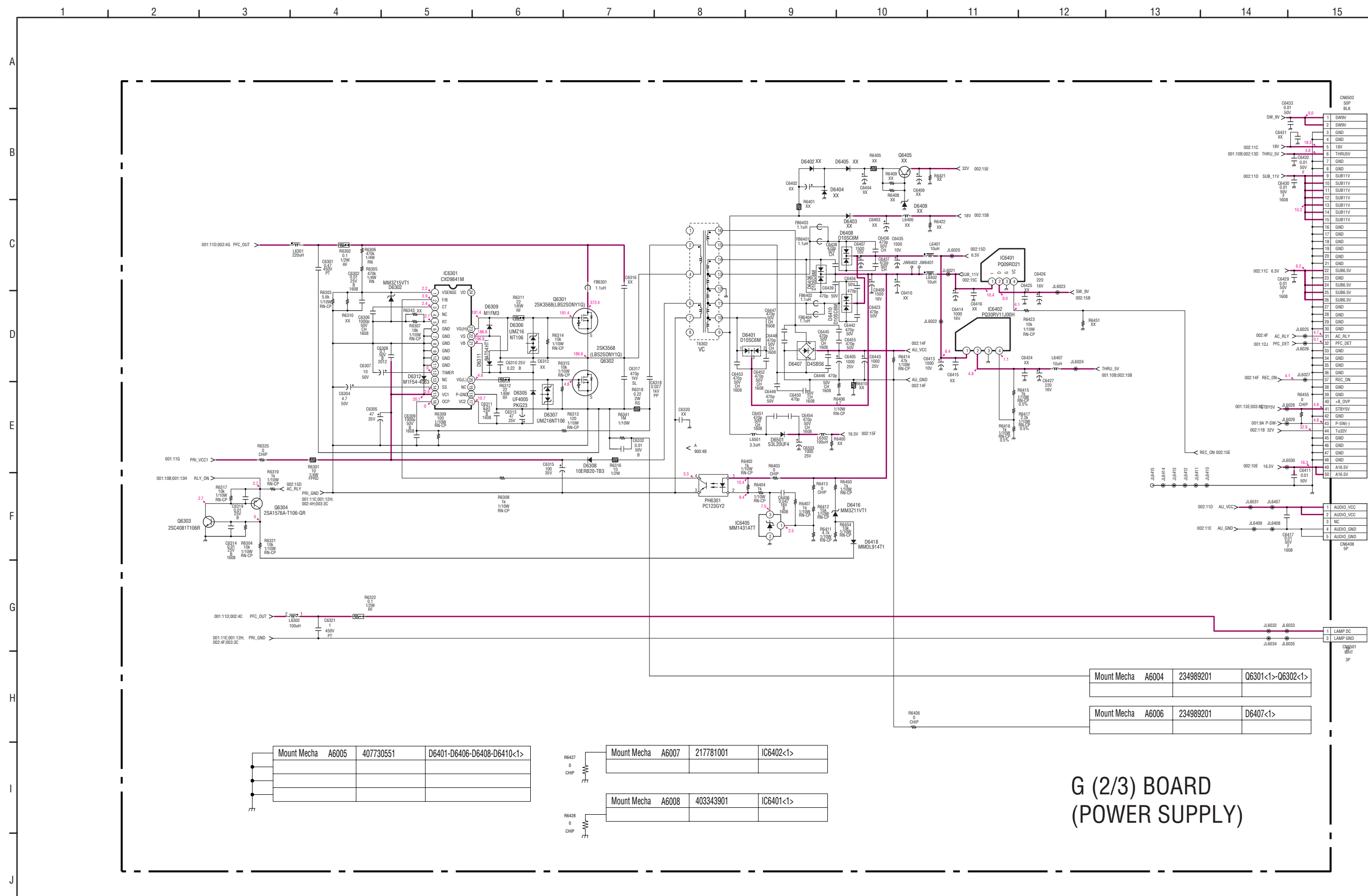

G (2/3) BOARD  
(POWER SUPPLY)

(5) Schematic Diagram of G (3/3) Board

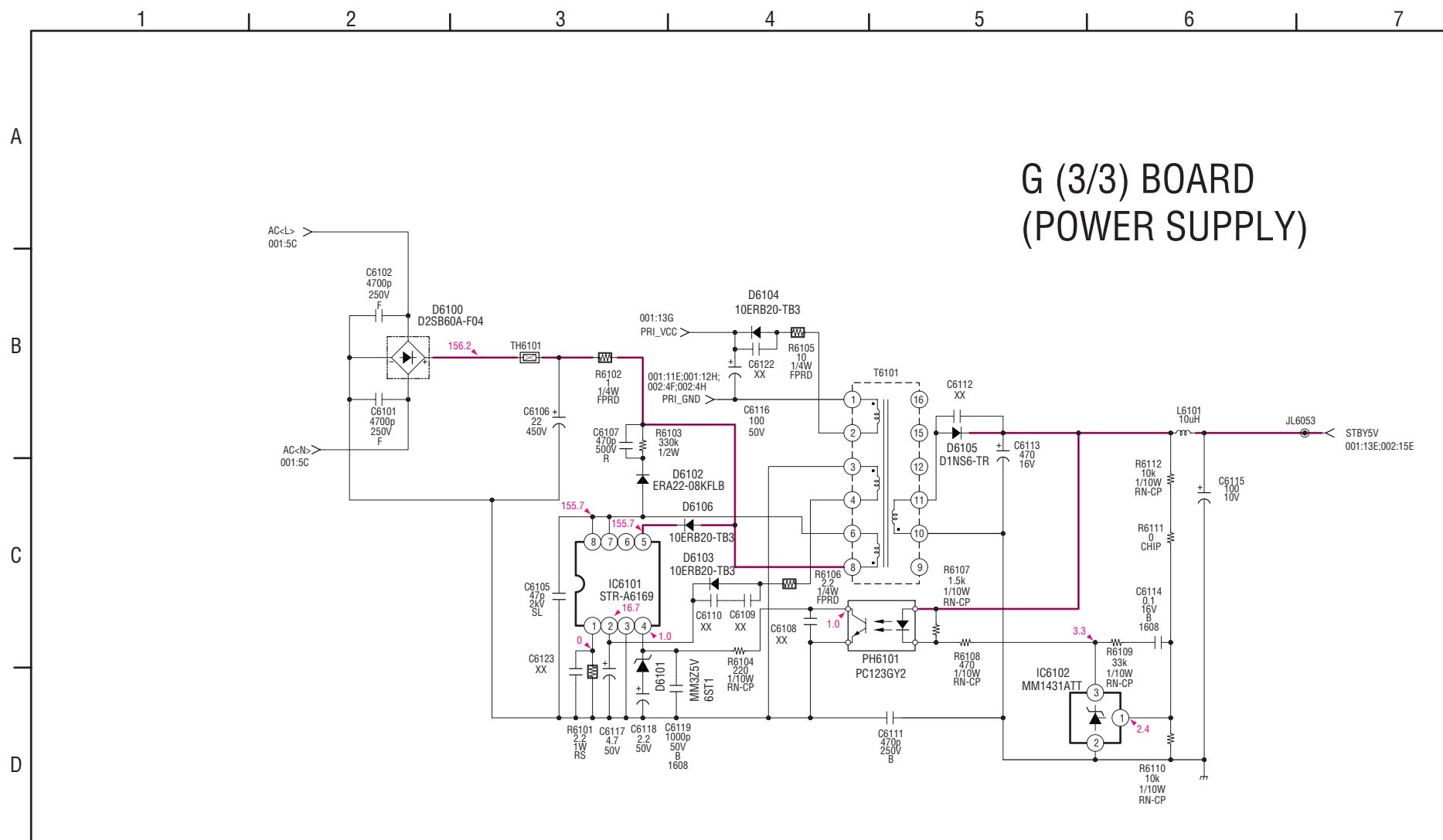



(7) Schematic Diagram of H1 Board

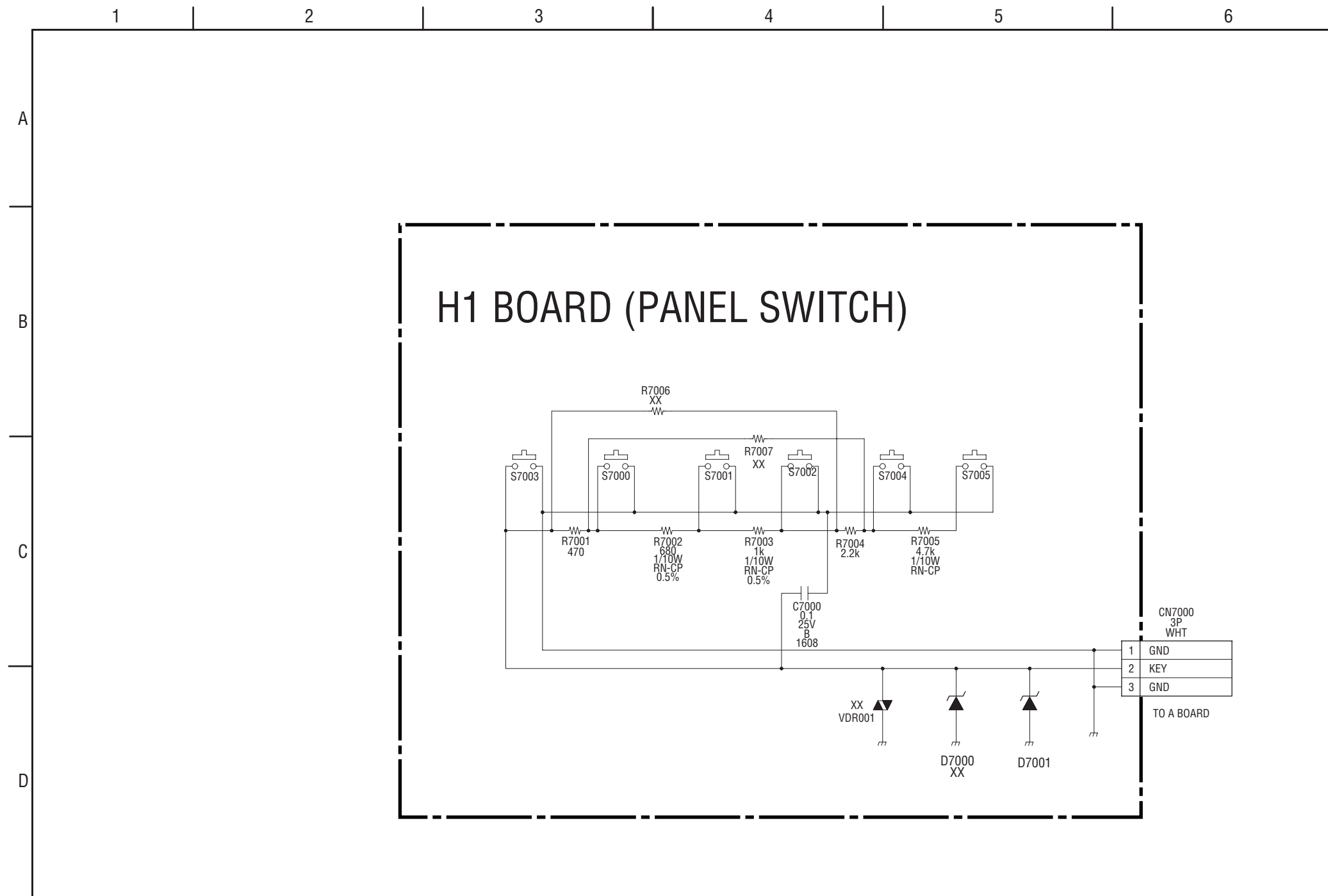

(8) Schematic Diagram of H2 Board

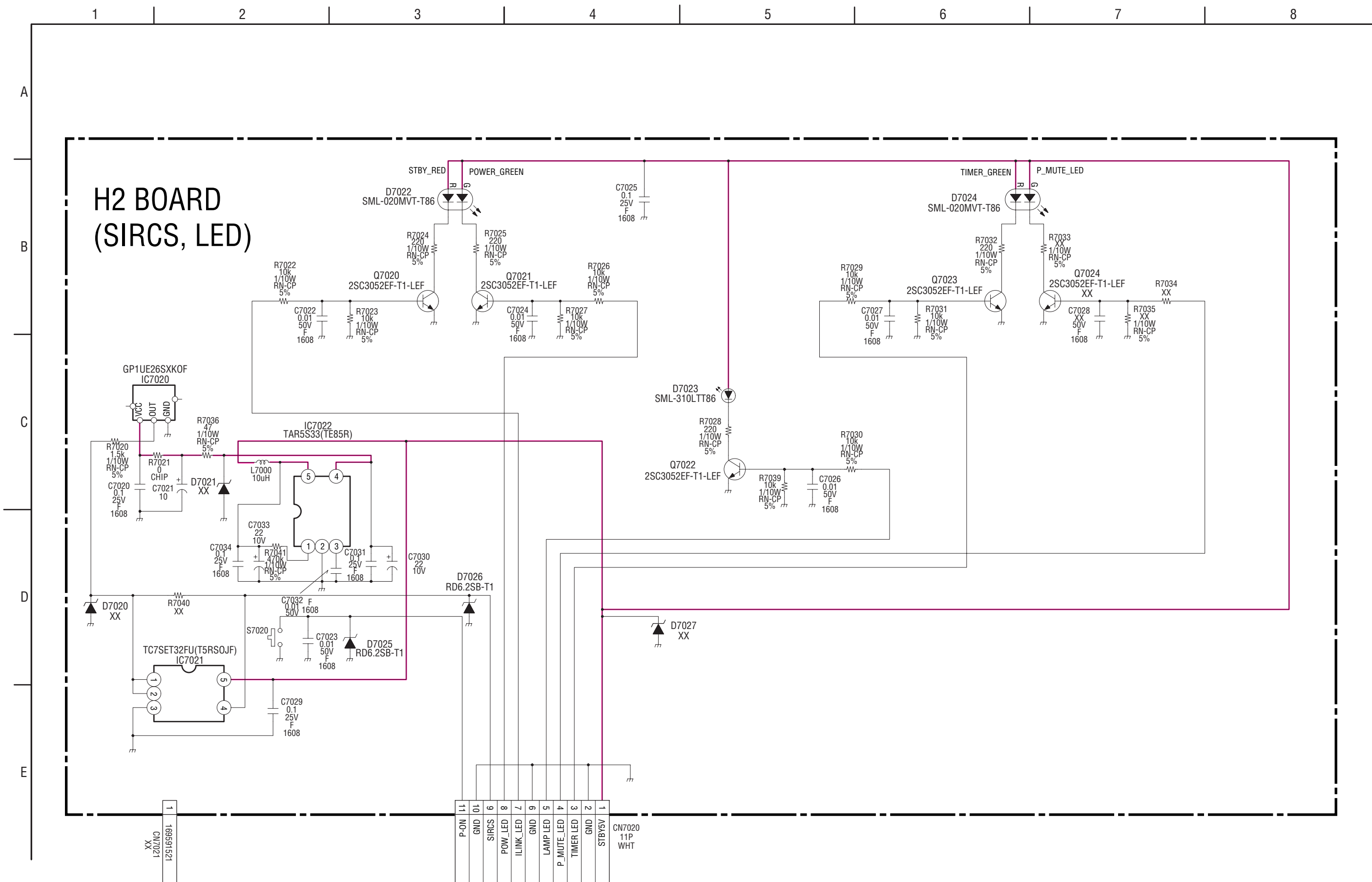



(9) Schematic Diagram of H3 Board

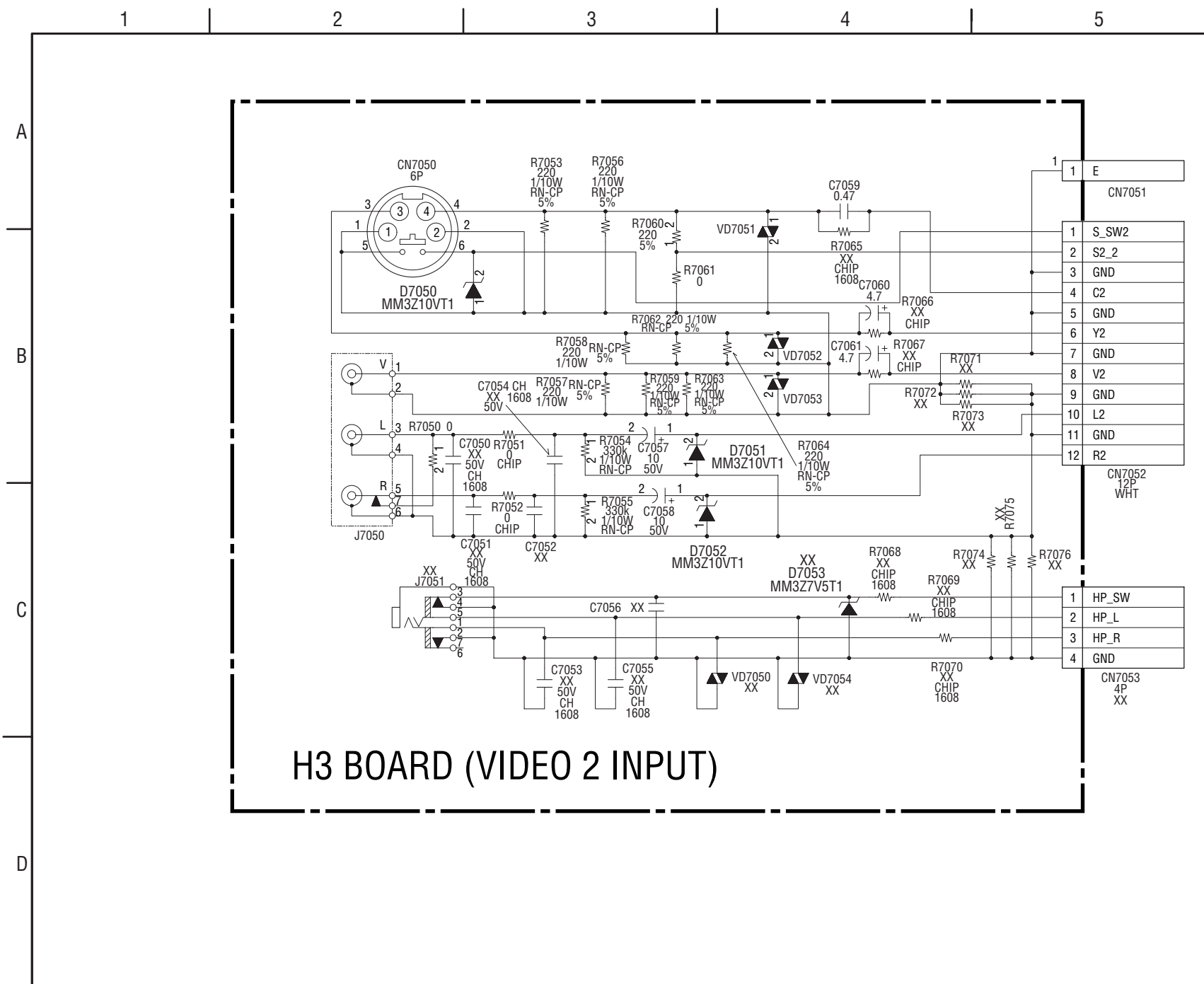

H3 BOARD (VIDEO 2 INPUT)

(10) Schematic Diagram of QU Board

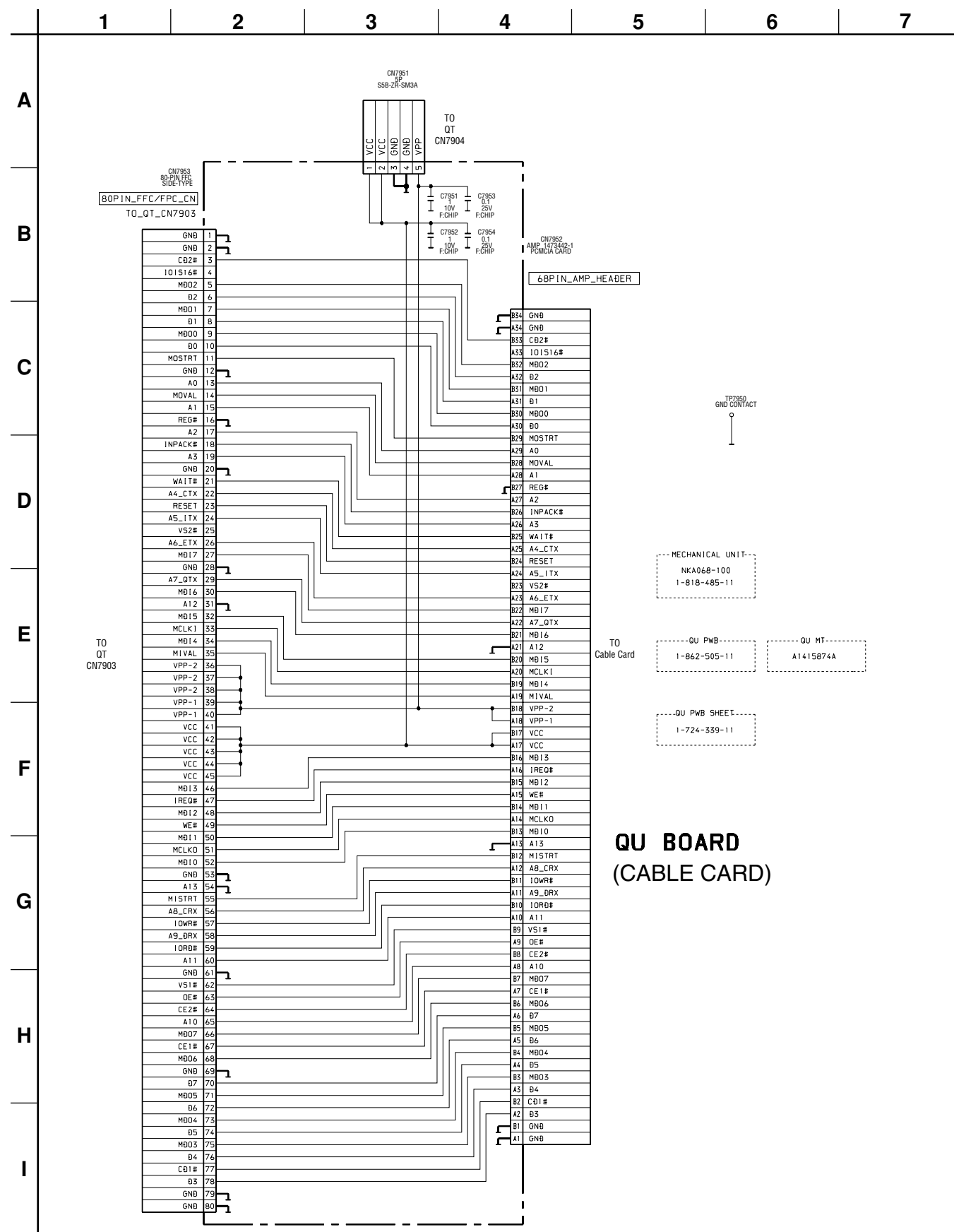

QU BOARD  
(CABLE CARD)

(11) Schematic Diagram of S1, S2 Boards

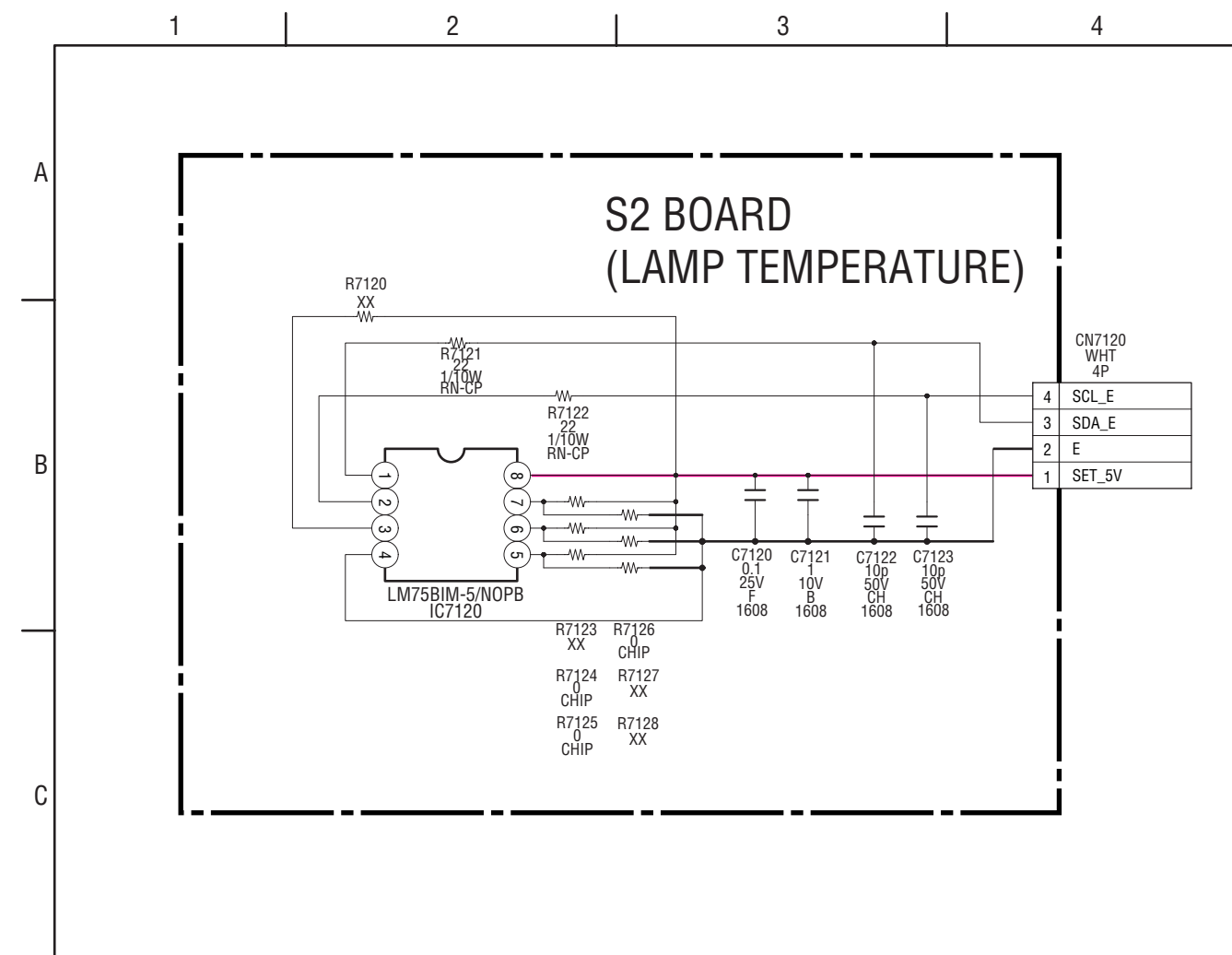
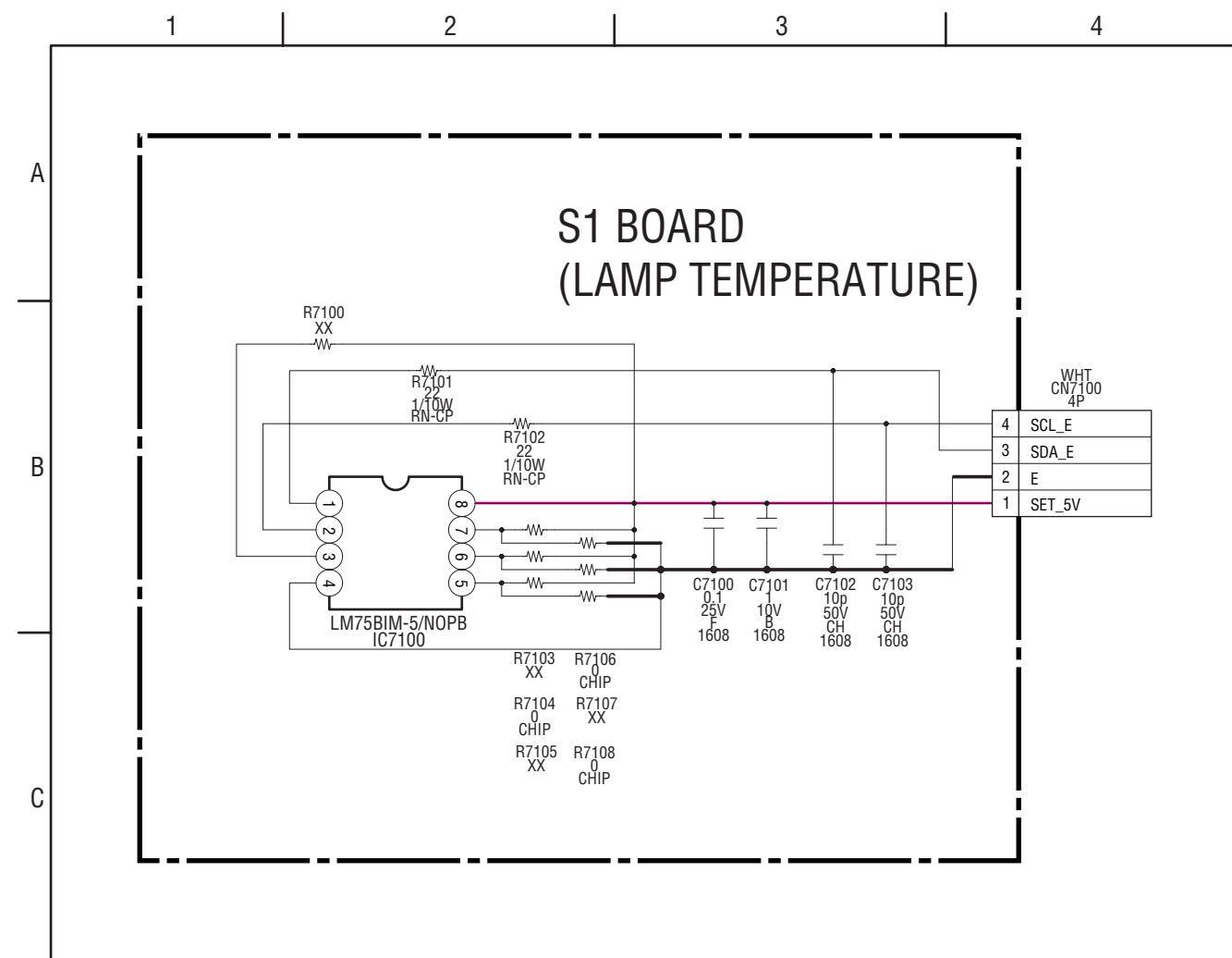

(12) Schematic Diagram of T1, T3 Boards

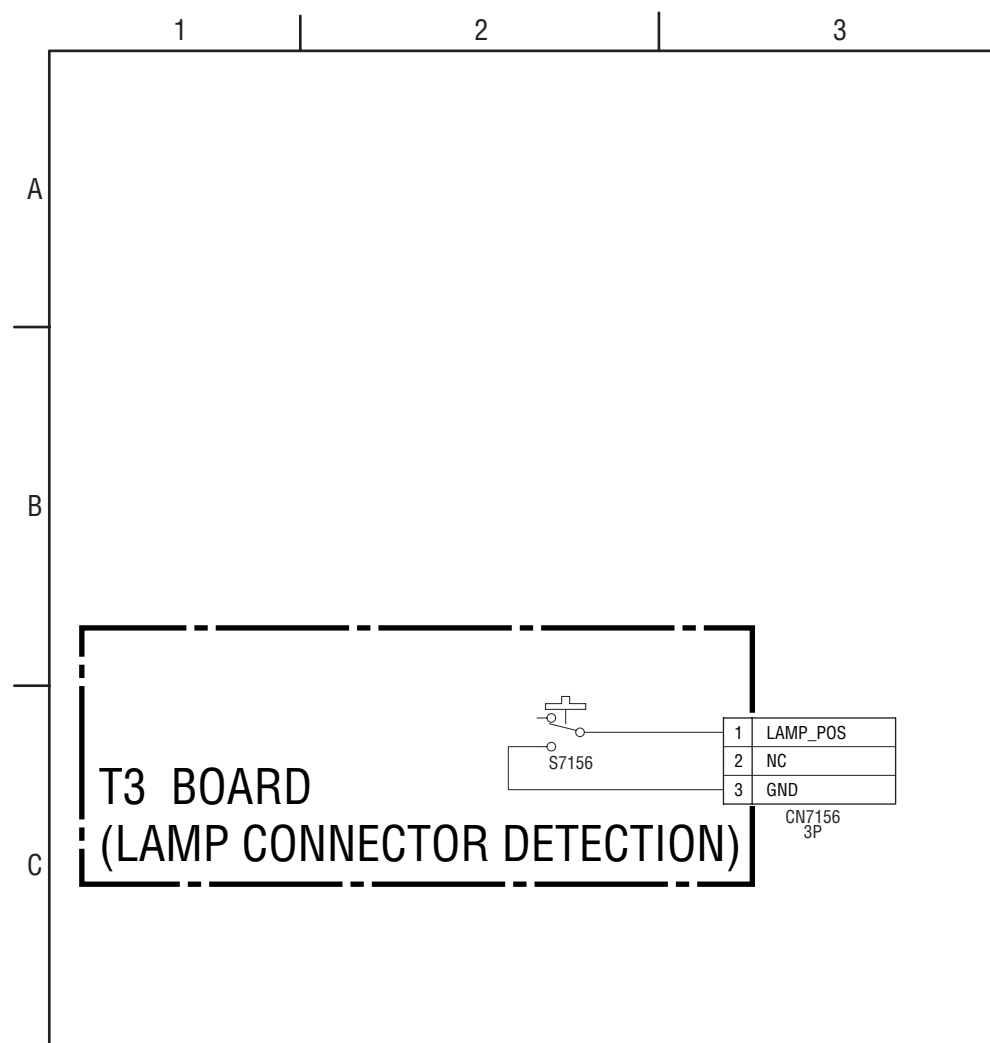
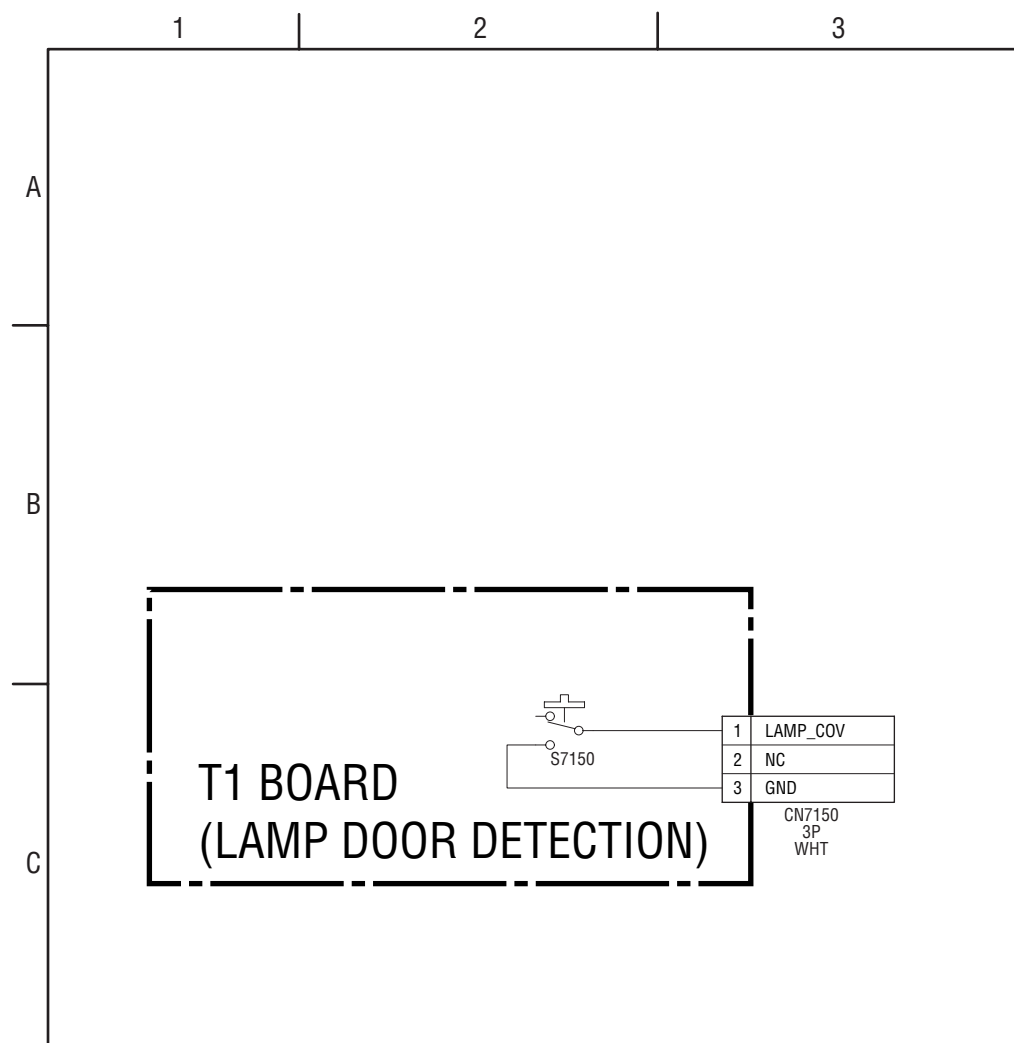

4-5. PRINTED WIRING BOARDS

(1) AK Board

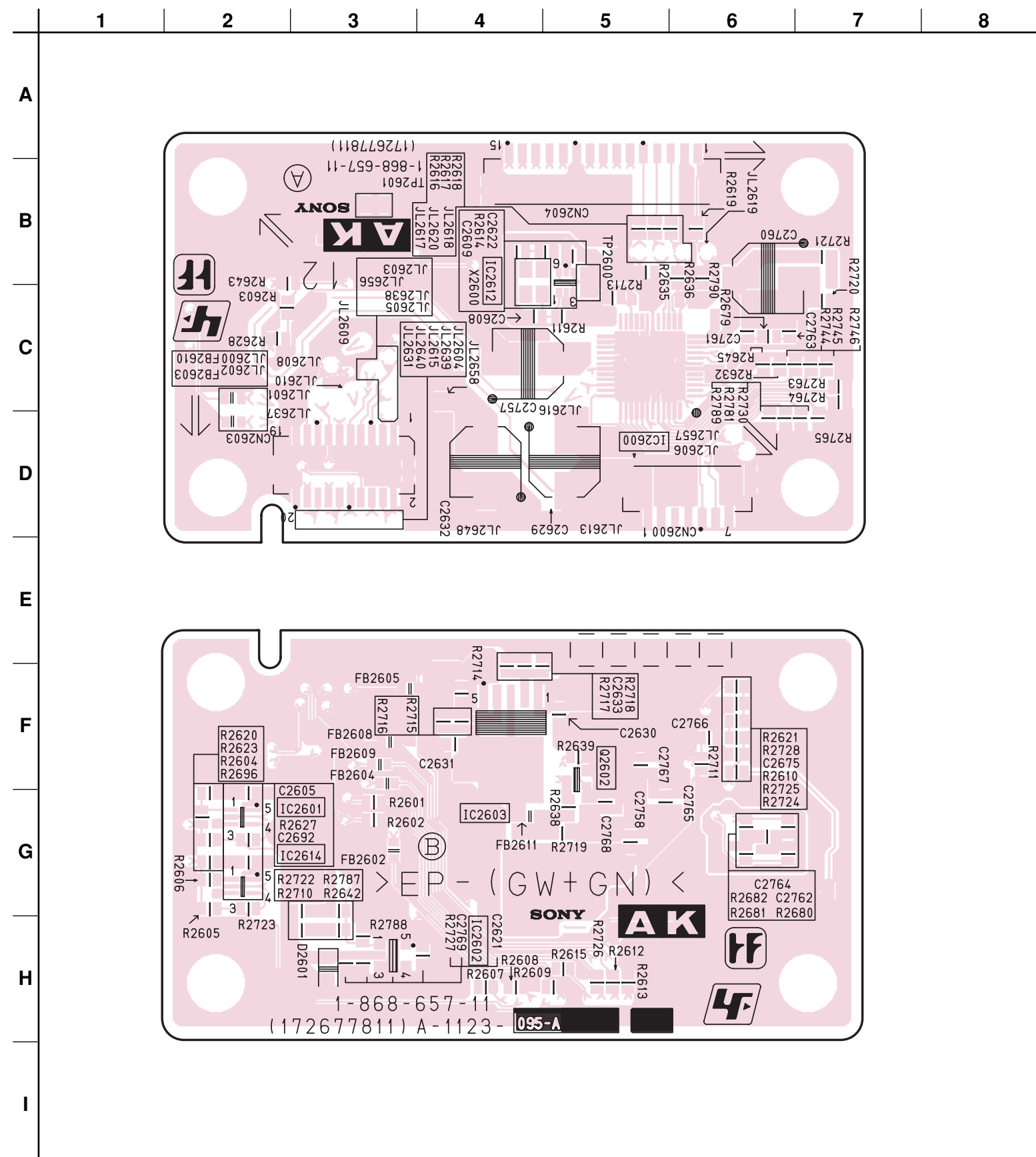

• AK BOARD SEMICONDUCTOR LOCATION

IC	Side A Side B *	
	IC2600	D-5
IC2601		G-3
IC2602		H-4
IC2603		G-4
IC2612	B-4	
IC2614		G-3
TRANSISTOR		
Side A Side B *		
Q2602	F-5	②
DIODE		
Side A Side B *		
D2601	H-3	③

\*: Refer to Terminal name of semiconductors in silk screen printed circuit (see page 39)

(2) F Board

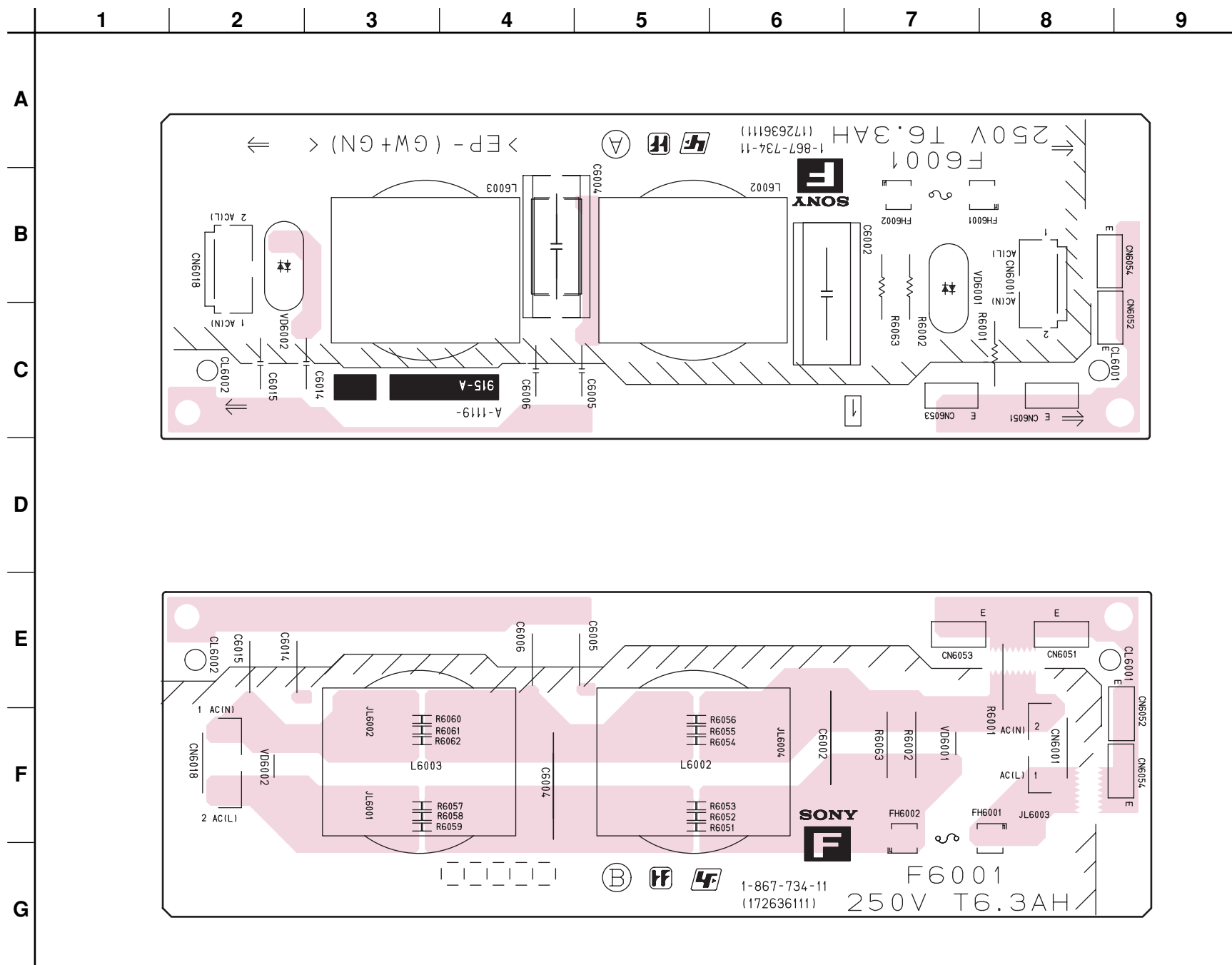

(3) G Board (Side A)

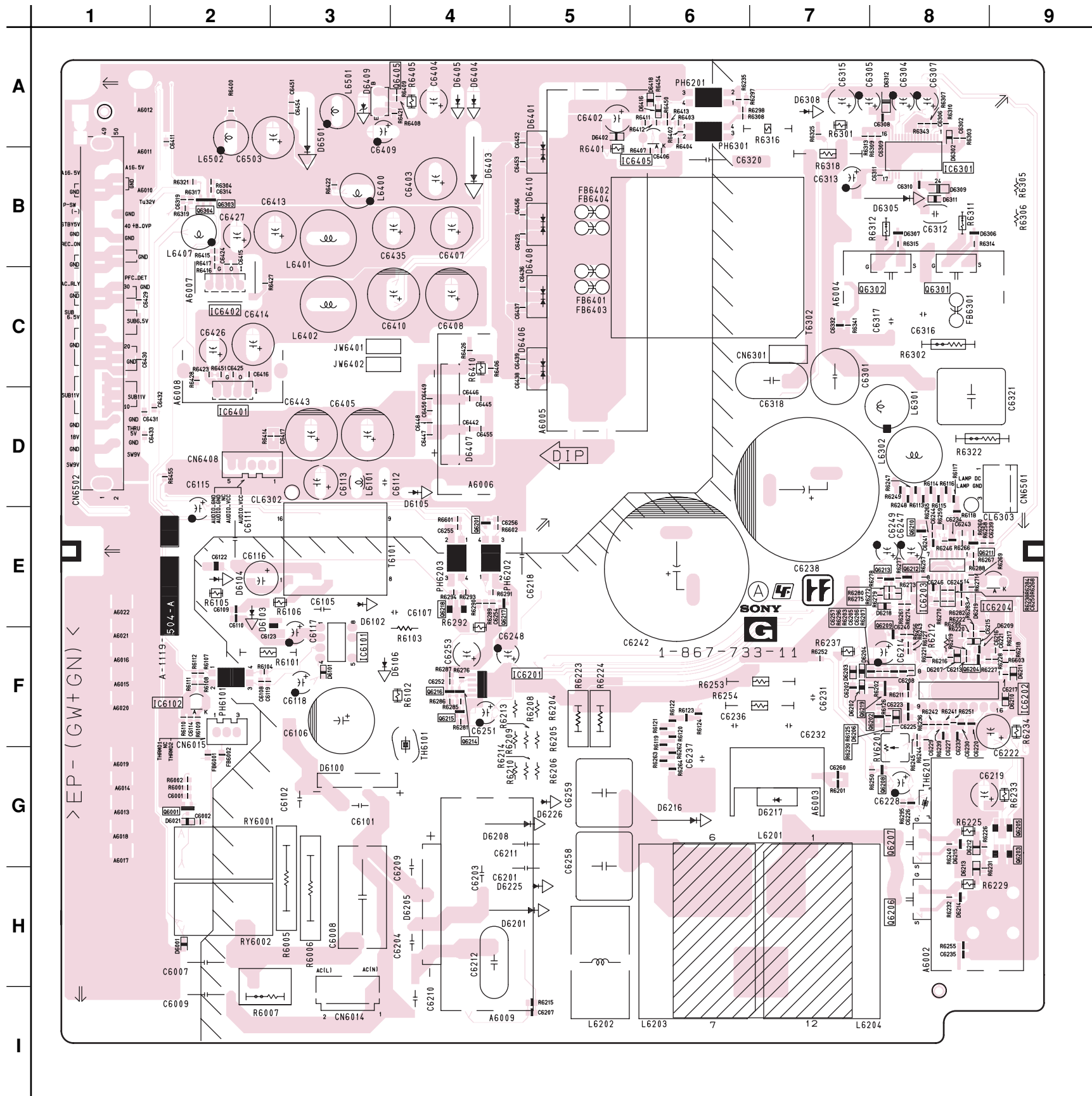

• G BOARD SEMICONDUCTOR LOCATION

IC	Side A		*	DIODE		*
	Side A	Side B		Side A	Side B	
IC6101	F-3	F-6		D6001	H-2	③
IC6102	F-2	F-8		D6021	G-2	③
IC6201	F-5	F-1		D6100	G-3	G-7
IC6202	F-9	F-1		D6101	F-3	③
IC6203	E-8			D6102	E-3	E-6
IC6204	E-9	E-1		D6103	E-2	E-7
IC6301	B-8			D6104	E-2	E-7
IC6401	D-2	D-7		D6105	D-4	D-6
IC6402	C-2	C-7		D6106	F-3	F-6
IC6405	B-6	A-4		D6201	H-5	H-5
<b>TRANSISTOR</b>						
IC	Side A		*	DIODE		*
	Side A	Side B		Side A	Side B	
Q6001	G-2		②	D6202	F-7	③
Q6201	E-4		②	D6203	F-7	③
Q6202	F-8		②	D6204	F-7	③
Q6203	G-9		②	D6205	H-4	H-6
Q6204	F-8		②	D6206	F-8	③
Q6205	G-9		②	D6207	F-8	③
Q6206	H-8	H-2	①	D6208	G-4	G-5
Q6207	G-8	G-2	①	D6209	F-8	③
Q6208	G-8		②	D6210	F-9	③
Q6209	F-8		②	D6211	F-9	③
Q6210	E-8		②	D6212	G-8	③
Q6211	E-8		②	D6213	H-8	③
Q6212	F-8		②	D6214	H-8	③
Q6213	F-8		②	D6215	G-8	③
Q6214	F-4		②	D6216	G-6	G-4
Q6215	F-4		②	D6217	G-7	G-3
Q6216	E-4		②	D6218	E-8	③
Q6217	E-4		②	D6219	E-8	③
Q6218	F-4		②	D6220	G-5	H-5
Q6219	F-8		②	D6221	G-5	G-4
Q6301	C-8	C-2	①	D6302	A-8	③
Q6302	C-8	C-2	①	D6305	B-8	B-8
Q6303	B-2		②	D6306	B-8	③
Q6304	B-2		②	D6307	B-8	③
				D6308	A-7	A-3
				D6309	B-8	③
				D6311	B-8	③
				D6312	A-8	③
				D6401	A-5	B-5
				D6406	C-5	C-5
				D6407	D-4	D-6
				D6408	C-5	C-5
				D6410	B-5	B-5
				D6416	A-6	③
				D6418	A-6	③
				D6501	A-3	A-7

\*: Refer to Terminal name of semiconductors in silk screen printed circuit (see page 39)

(4) G Board (Side B)

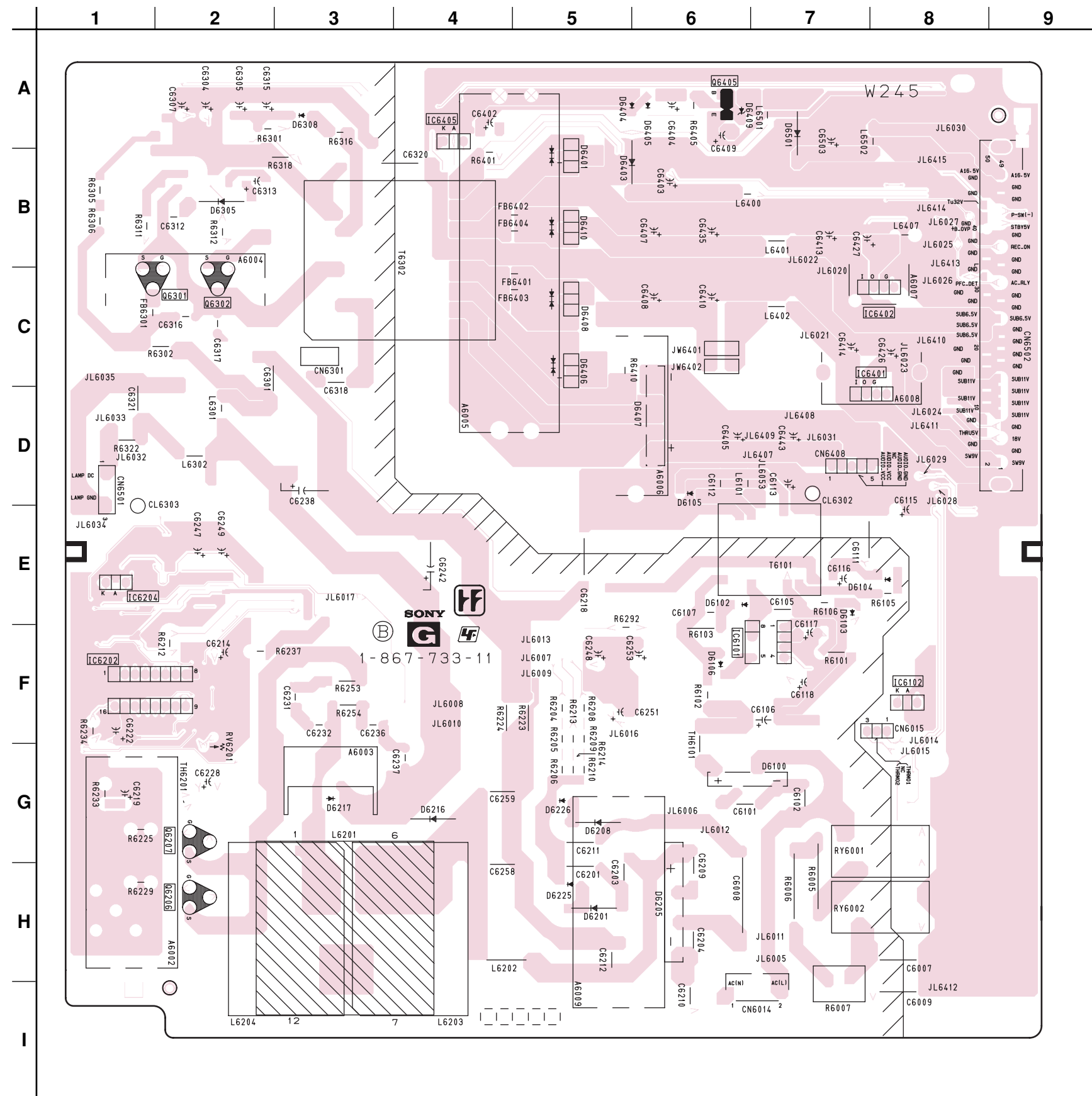

• G BOARD SEMICONDUCTOR LOCATION

IC				DIODE			
	Side A	Side B	*	Side A	Side B	*	
IC6101	F-3	F-6		D6001	H-2		③
IC6102	F-2	F-8		D6021	G-2		③
IC6201	F-5			D6100	G-3	G-7	
IC6202	F-9	F-1		D6101	F-3		③
IC6203	E-8			D6102	E-3	E-6	
IC6204	E-9	E-1		D6103	E-2	E-7	
IC6301	B-8			D6104	E-2	E-7	
IC6401	D-2	D-7		D6105	D-4	D-6	
IC6402	C-2	C-7		D6106	F-3	F-6	
IC6405	B-6	A-4		D6201	H-5	H-5	
TRANSISTOR							
	Side A	Side B	*				
Q6001	G-2		②	D6202	F-7		③
Q6201	E-4		②	D6203	F-7		③
Q6202	F-8		②	D6204	F-7		③
Q6203	G-9		②	D6205	H-4	H-6	
Q6204	F-8		②	D6206	F-8		③
Q6205	G-9		②	D6207	F-8		③
Q6206	H-8	H-2	①	D6208	G-4	G-5	
Q6207	G-8	G-2	①	D6209	F-8		③
Q6208	G-8		②	D6210	F-9		③
Q6209	F-8		②	D6211	F-9		③
Q6210	E-8		②	D6212	G-8		③
Q6211	E-8		②	D6213	H-8		③
Q6212	E-8		②	D6214	H-8		③
Q6213	E-8		②	D6215	G-8		③
Q6214	F-4		②	D6216	G-6	G-4	
Q6215	E-4		②	D6217	G-7	G-3	
Q6216	E-4		②	D6218	E-8		③
Q6217	E-4		②	D6219	E-8		③
Q6218	E-4		②	D6225	G-5	H-5	
Q6219	F-8		②	D6226	G-5	G-4	
Q6301	C-8	C-2	①	D6302	A-8		③
Q6302	C-8	C-2	①	D6305	B-8		③
Q6303	B-2		②	D6306	B-8		③
Q6304	B-2		②	D6307	B-8		③
				D6308	A-7	A-3	
				D6309	B-8		③
				D6311	B-8		③
				D6312	A-8		③
				D6401	A-5	B-5	
				D6406	C-5	C-5	
				D6407	D-4	D-6	
				D6408	C-5	C-5	
				D6410	B-5	B-5	
				D6416	A-6		③
				D6418	A-6		③
				D6501	A-3	A-7	

\*: Refer to Terminal name of semiconductors in silk screen printed circuit (see page 39)







(7) QU, S1, S2, T1, T3 Boards

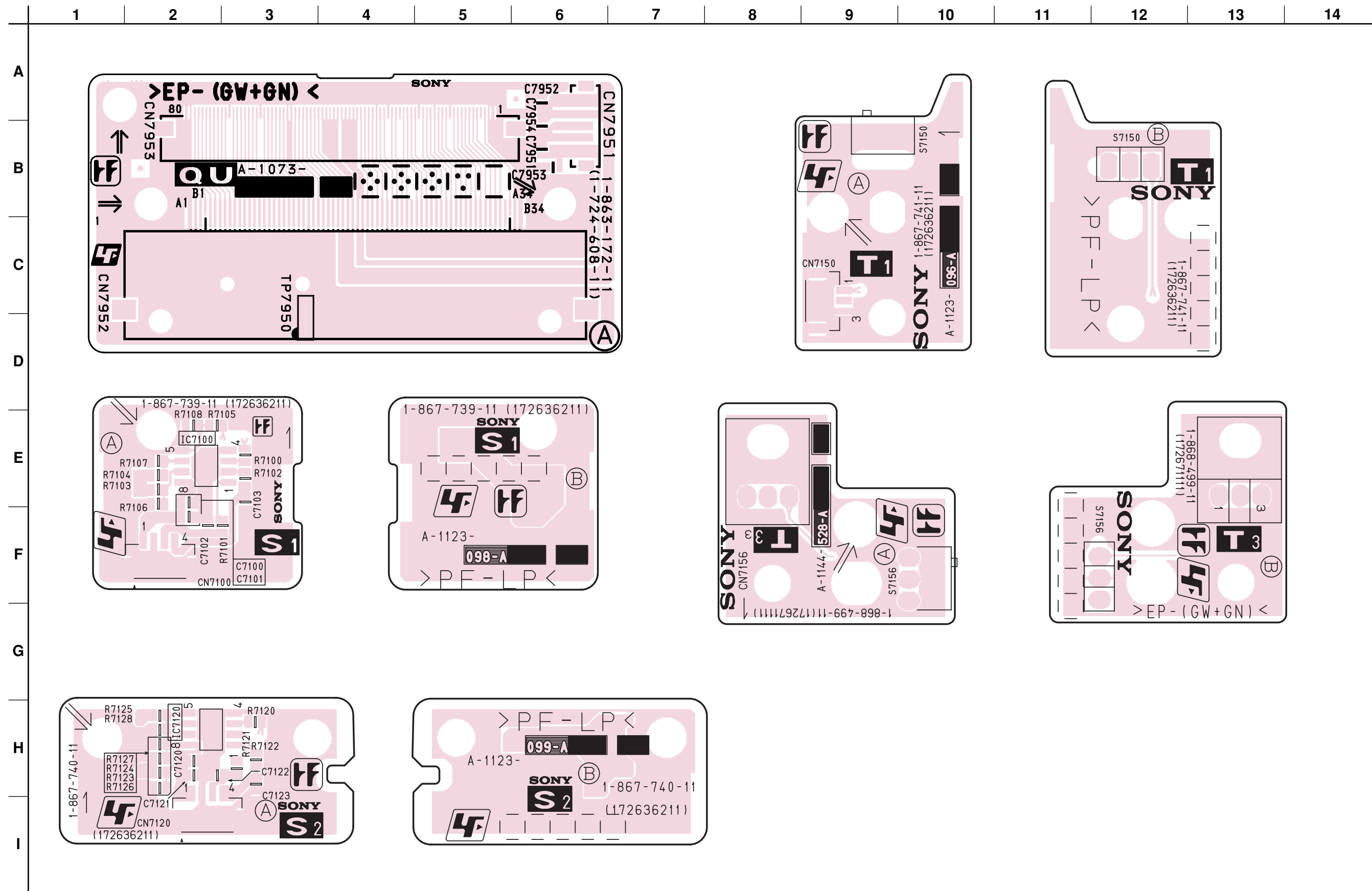

**4-6. SEMICONDUCTORS**

LM75BIM-5/NOPB

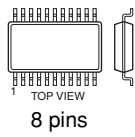

MM1431ATT  
TC7SET32FU(TE85L)

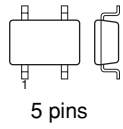

PQ09RD21J00H

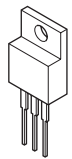

PQ30RV11J00H

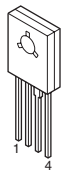

2SA1576A-T106-QR  
2SB709A-QRS-TX  
2SC1623-L5L6  
2SC4081-R  
2SD2114K  
2SD601A-Q  
DTC114EU

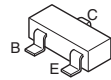

10ERB20-TB3  
D1NS6  
UF4005/23

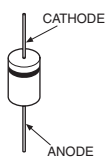

1SS226

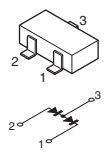

D10SC6M

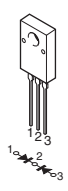

D2SB60A-F04  
D4SBS6

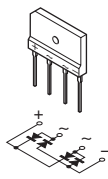

DTZ10B  
MA113-(TX)  
MMDL914T1  
RD5.6SB-T1  
UDZ-TE-17-3.9B  
UDZ-TE-17-7.5B

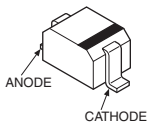

ERA22-08KFLB  
S3L20UF4

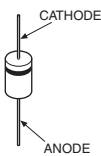

MM3Z11VT1  
MM3Z15VT1  
MM3Z7V5T1  
RD6.2SB

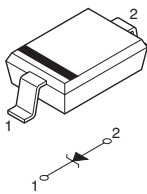

## SECTION 5 EXPLODED VIEWS

**NOTE:**

- Items with no part number and no description are not stocked because they are seldom required for routine service
- The construction parts of an assembled part are indicated with a collation number in the remark column.
- Items marked " \* " are not stocked since they are seldom required for routine service. Some delay should be anticipated when ordering these items.

The components identified by shading and mark  $\Delta$  are critical for safety. Replace only with part number specified.

Les composants identifiés par une trame et une marque  $\Delta$  sont critiques pour la sécurité. Ne les remplacer que par une pièce portant le numéro spécifié.

### 1. SCREEN, COVERS

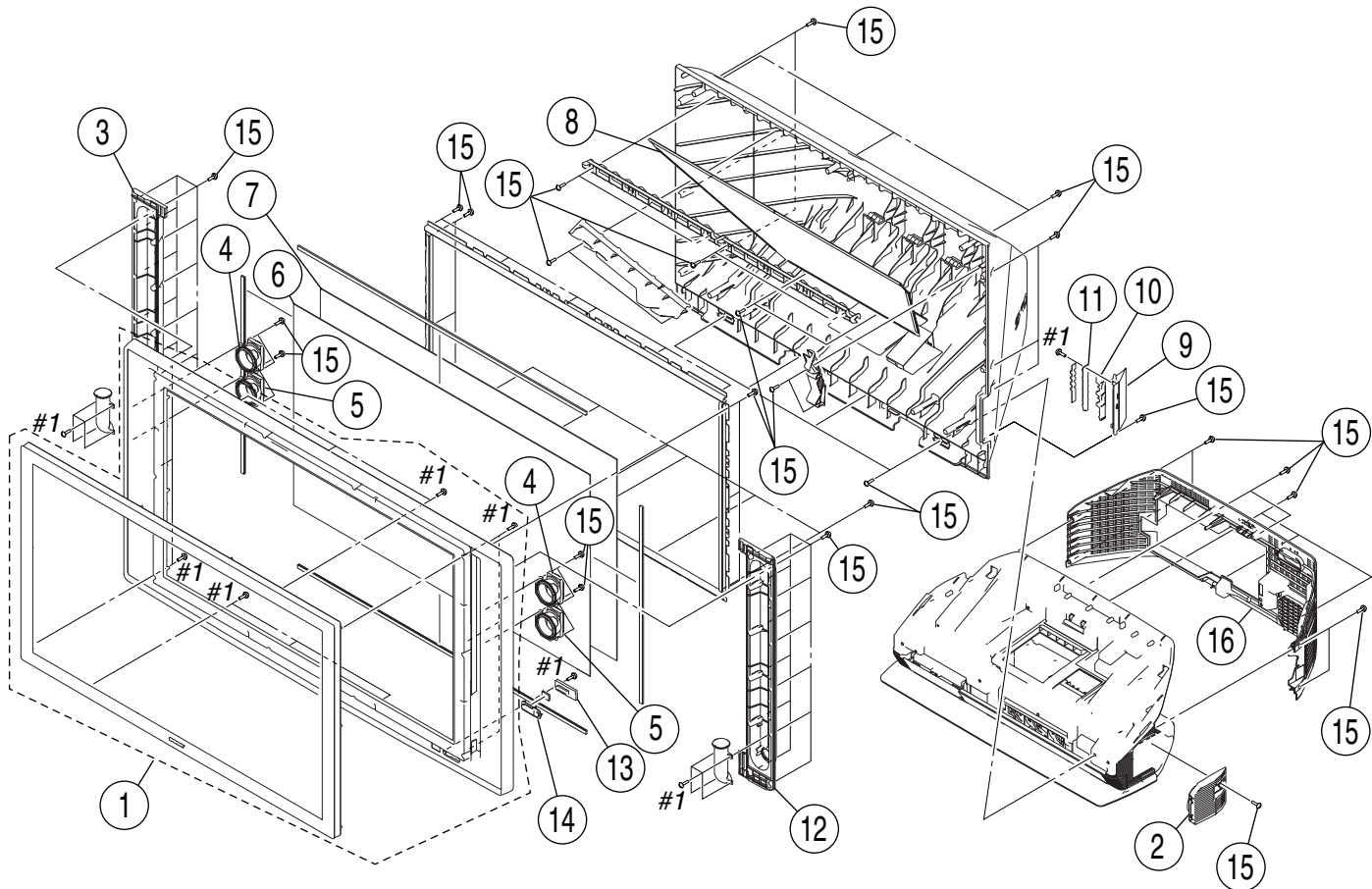

REF. NO.	PART NO.	DESCRIPTION	REMARK	REF. NO.	PART NO.	DESCRIPTION	REMARK
1	A-1153-225-A	SCREEN FRM BEZEL (50) ASSY		9	2-633-452-01	BRACKET (50), H1	(R50XBR1)
1	X-1153-224-A	SCREEN FRM BEZEL (60) ASSY		9	2-633-472-01	BRACKET (60), H1	(R60XBR1)
2	X-2059-788-1	DOOR ASSY, LAMP		10	2-633-473-01	H1 BUTON	
3	2-633-426-01	BOX (L) (60), SPEAKER	(R60XBR1)	11	A-1123-100-A	H1 BOARD, COMPLETE	
3	2-633-669-01	BOX (L) (50), SPEAKER	(R50XBR1)	12	2-633-427-01	BOX (R) (60), SPEAKER	(R60XBR1)
4	1-826-236-11	LOUDSPEAKER		12	2-633-670-01	BOX (R) (50), SPEAKER	(R50XBR1)
5	1-826-237-11	LOUDSPEAKER		13	A-1123-101-A	H2 BOARD, COMPLETE	
6	2-630-902-11	PLATE (50L), DIFFUSION	(R50XBR1)	14	2-633-425-01	PANEL,H2	
6	2-630-904-11	PLATE (60L), DIFFUSION	(R60XBR1)	15	2-580-640-01	SCREW, +BVTP2 4X16	
7	1-788-162-21	PLATE (50F), DIFFUSION	(R50XBR1)	16	2-633-437-01	COVER, REAR	
7	2-630-905-11	PLATE (60F), DIFFUSION	(R60XBR1)	#1	7-685-648-79	SCREW +BVTP 3X12 TYPE2 IT-3	
8	A-1153-223-A	MIRROR (50)	(R50XBR1)				
8	A-1146-733-A	MIRROR (60)	(R60XBR1)				

2. BOTTOM BLOCK-1

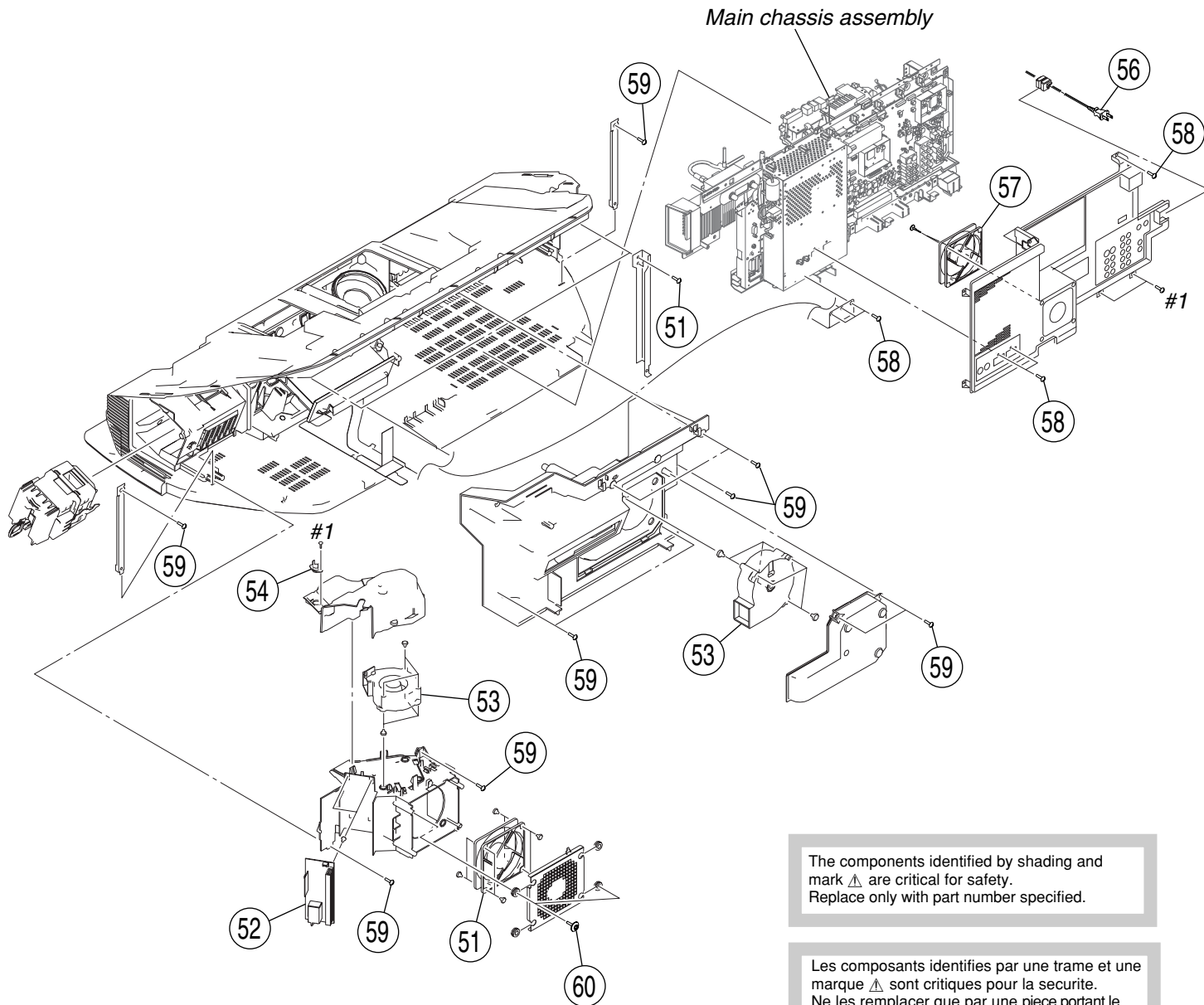

The components identified by shading and mark  $\triangle$  are critical for safety. Replace only with part number specified.

Les composants identifiés par une trame et une marque  $\triangle$  sont critiques pour la sécurité. Ne les remplacer que par une pièce portant le numéro spécifié.

REF. NO.	PART NO.	DESCRIPTION	REMARK	REF. NO.	PART NO.	DESCRIPTION	REMARK
51	$\triangle$ 8-835-860-11	MOTOR, DC SFF21C/C-NP		57	$\triangle$ 1-787-333-11	D.C. FAN	
52	$\triangle$ 1-468-936-12	POWER SUPPLY BLOCK		58	2-580-628-01	SCREW, +BVST 3X6	
53	$\triangle$ 8-835-859-11	MOTOR, DC SFF22A/C-NP		59	2-580-640-01	SCREW, +BVTP2 4X16	
54	1-576-885-11	THERMOSTAT		60	2-580-654-01	SCREW, +PWTP2 4X16	
56	1-791-192-13	CORD, NOISE FILTER WITH POWER		#1	7-685-648-79	SCREW +BVTP 3X12 TYPE2 IT-3	

3. BOTTOM BLOCK-2

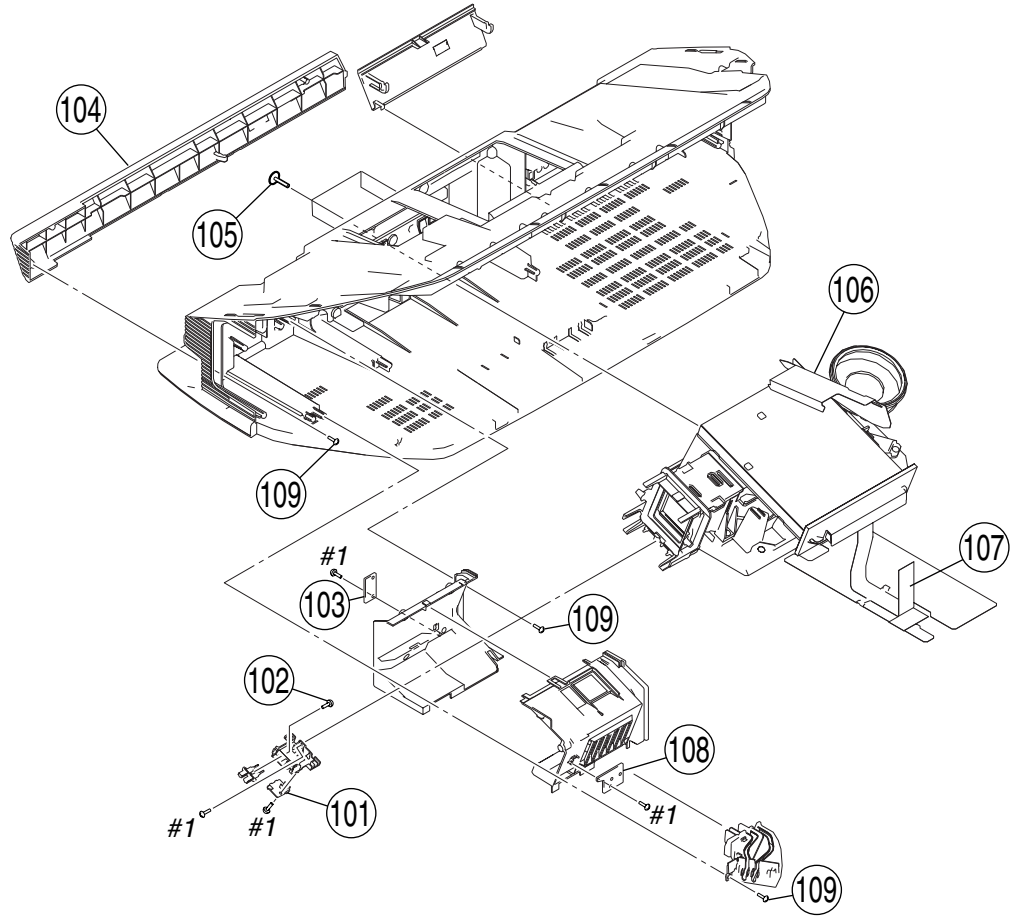

REF. NO.	PART NO.	DESCRIPTION	REMARK	REF. NO.	PART NO.	DESCRIPTION	REMARK
101	A-1144-528-A	T3 BOARD, COMPLETE		106	A-1127-174-A	BLOCK ASSY, OPTICS	(R60XBR1)
102	3-252-830-01	SCREW (B3), (+) PWH TAPPING		106	A-1148-155-A	BLOCK ASSY, OPTICS	(R50XBR1)
103	A-1123-099-A	S2 BOARD, COMPLETE		107	1-830-856-11	FLEXIBLE FLAT CABLE	
104	2-633-441-01	COVER, FRONT		108	A-1123-096-A	T1 BOARD, COMPLETE	
105	2-580-602-01	SCREW, +PSW M4X12		109	2-580-640-01	SCREW, +BVTP2 4X16	
				#1	7-685-648-79	SCREW +BVTP 3X12 TYPE2 IT-3	

4. MAIN CHASSIS ASSEMBLY

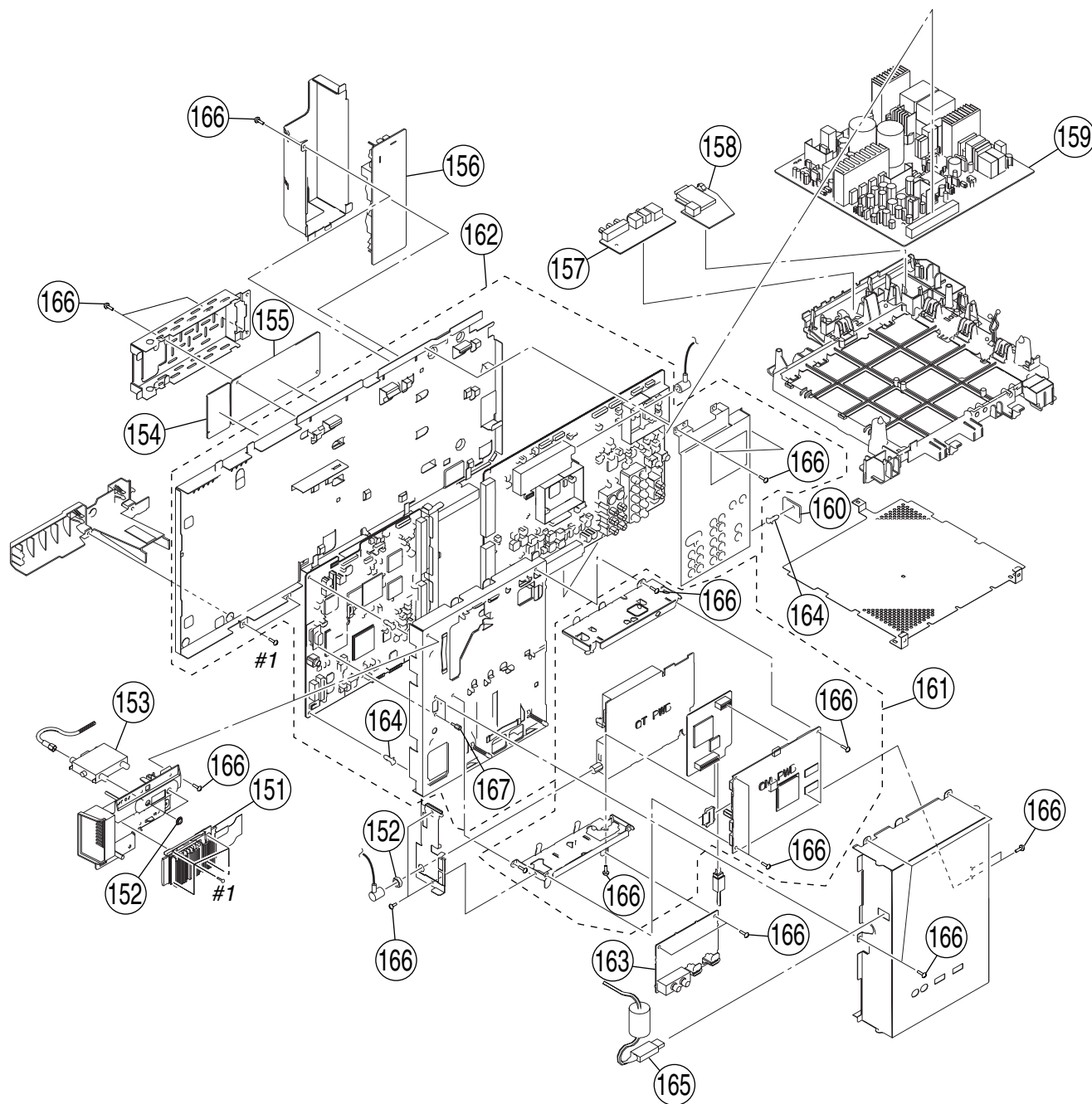

REF. NO.	PART NO.	DESCRIPTION	REMARK	REF. NO.	PART NO.	DESCRIPTION	REMARK
151	* A-1073-391-A	QU BOARD, COMPLETE		161	A-1152-712-A	Q BOX ASSY	(R60XBR1)
152	3-682-691-00	NUT, WASHER HEXAGON		161	A-1152-713-A	Q BOX ASSY	(R50XBR1)
153	8-597-906-00	ANTENNA SWITCHE RFD-SA801		162	A-1152-714-A	ASU/DSU ASSY	(R60XBR1)
154	A-1123-095-A	AK BOARD, COMPLETE		162	A-1152-715-A	ASU/DSU ASSY	(R50XBR1)
155	A-1138-895-A	K BOARD, COMPLETE		163	A-1152-716-A	PD BOARD, COMPLETE	
156	A-1119-915-A	F BOARD, COMPLETE		164	* 3-952-863-11	SPACER, CIRCUIT BOARD	
157	A-1123-102-A	H3 BOARD, COMPLETE		165	1-830-193-11	CABLE, USB	
158	A-1060-186-A	HM BOARD, COMPLETE		166	2-580-628-01	SCREW, +BVST 3X6	
159	A-1138-898-A	G BOARD, COMPLETE		167	2-580-626-01	SCREW, SP 4-40 UNC	
160	A-1123-098-A	S1 BOARD, COMPLETE		#1	7-685-648-79	SCREW +BVTP 3X12 TYPE2 IT-3	



## SECTION 6

## ELECTRICAL PARTS LIST

AK

The components identified by shading and mark  $\Delta$  are critical for safety. Replace only with part number specified.

Les composants identifiés par une trame et une marque  $\Delta$  sont critiques pour la sécurité. Ne les remplacer que par une pièce portant le numéro spécifié.

When indicating parts by reference number, please include the board name.

• Items marked " \* " are not stocked since they are seldom required for routine service. Some delay should be anticipated when ordering these items.

• RESISTORS  
All resistors are in ohms  
F : nonflammable

• CAPACITORS  
PF :  $\mu\text{F}$

• There are some cases the reference number on one board overlaps on the other board. Therefore, when ordering parts by the reference number, please include the board name.

REF. NO.	PART NO.	DESCRIPTION	REMARK	REF. NO.	PART NO.	DESCRIPTION	REMARK
A-1123-095-A AK BOARD, COMPLETE *****				< IC >			
< CAPACITOR >				< TRANSISTOR >			
C2605	1-107-826-11	CERAMIC CHIP	0.1 $\mu\text{F}$ 10% 16V	IC2600	8-759-825-15	IC LC89056W-E	
C2608	1-162-915-11	CERAMIC CHIP	10pF 0.50PF 50V	IC2601	6-703-046-01	IC SN74LVC1G08DCKR	
C2609	1-162-915-11	CERAMIC CHIP	10pF 0.50PF 50V	IC2602	6-702-821-01	IC R3112N421A-TR-FA	
C2621	1-162-970-11	CERAMIC CHIP	0.01 $\mu\text{F}$ 10% 25V	IC2603	6-705-403-01	IC PQ070XZ01ZPH	
C2622	1-107-826-11	CERAMIC CHIP	0.1 $\mu\text{F}$ 10% 16V	IC2612	6-706-056-01	IC SN74LVC2GU04DCKR	
C2629	1-117-681-11	ELECT CHIP	100 $\mu\text{F}$ 20% 16V	IC2614	6-703-046-01	IC SN74LVC1G08DCKR	
C2630	1-107-826-11	CERAMIC CHIP	0.1 $\mu\text{F}$ 10% 16V	< RESISTOR >			
C2631	1-107-826-11	CERAMIC CHIP	0.1 $\mu\text{F}$ 10% 16V	Q2602	8-729-907-00	TRANSISTOR DTC114EU	
C2632	1-117-681-11	ELECT CHIP	100 $\mu\text{F}$ 20% 16V	< RESISTOR >			
C2633	1-125-891-11	CERAMIC CHIP	0.47 $\mu\text{F}$ 10% 10V	R2601	1-216-864-11	SHORT CHIP	0
C2675	1-107-826-11	CERAMIC CHIP	0.1 $\mu\text{F}$ 10% 16V	R2602	1-216-864-11	SHORT CHIP	0
C2692	1-107-826-11	CERAMIC CHIP	0.1 $\mu\text{F}$ 10% 16V	R2603	1-216-864-11	SHORT CHIP	0
C2757	1-126-206-11	ELECT CHIP	100 $\mu\text{F}$ 20% 6.3V	R2606	1-216-864-11	SHORT CHIP	0
C2758	1-107-826-11	CERAMIC CHIP	0.1 $\mu\text{F}$ 10% 16V	R2607	1-216-864-11	SHORT CHIP	0
C2760	1-126-206-11	ELECT CHIP	100 $\mu\text{F}$ 20% 6.3V	R2608	1-216-864-11	SHORT CHIP	0
C2761	1-162-970-11	CERAMIC CHIP	0.01 $\mu\text{F}$ 10% 25V	R2609	1-216-864-11	SHORT CHIP	0
C2762	1-162-970-11	CERAMIC CHIP	0.01 $\mu\text{F}$ 10% 25V	R2610	1-216-805-11	METAL CHIP	47 5% 1/10W
C2763	1-107-826-11	CERAMIC CHIP	0.1 $\mu\text{F}$ 10% 16V	R2611	1-216-857-11	METAL CHIP	1M 5% 1/10W
C2764	1-107-826-11	CERAMIC CHIP	0.1 $\mu\text{F}$ 10% 16V	R2612	1-216-864-11	SHORT CHIP	0
C2765	1-107-826-11	CERAMIC CHIP	0.1 $\mu\text{F}$ 10% 16V	R2613	1-216-864-11	SHORT CHIP	0
C2766	1-164-245-11	CERAMIC CHIP	0.015 $\mu\text{F}$ 10% 25V	R2614	1-216-817-11	METAL CHIP	470 5% 1/10W
C2767	1-107-826-11	CERAMIC CHIP	0.1 $\mu\text{F}$ 10% 16V	R2615	1-216-864-11	SHORT CHIP	0
C2768	1-107-826-11	CERAMIC CHIP	0.1 $\mu\text{F}$ 10% 16V	R2616	1-216-864-11	SHORT CHIP	0
C2769	1-107-826-11	CERAMIC CHIP	0.1 $\mu\text{F}$ 10% 16V	R2617	1-216-864-11	SHORT CHIP	0
< CONNECTOR >				R2618	1-216-864-11	SHORT CHIP	0
CN2604	1-819-443-11	HEADER ASSEMBLY FOR PWB 15P		R2619	1-216-864-11	SHORT CHIP	0
< DIODE >				R2620	1-216-833-11	METAL CHIP	10K 5% 1/10W
D2601	8-719-065-68	DIODE MAZF04700LS0		R2621	1-216-864-11	SHORT CHIP	0
< FERRITE BEAD >				R2623	1-216-809-11	METAL CHIP	100 5% 1/10W
FB2602	1-414-228-11	FERRITE	0 $\mu\text{H}$	R2627	1-216-809-11	METAL CHIP	100 5% 1/10W
FB2603	1-414-228-11	FERRITE	0 $\mu\text{H}$	R2628	1-216-809-11	METAL CHIP	100 5% 1/10W
FB2604	1-414-228-11	FERRITE	0 $\mu\text{H}$	R2632	1-216-864-11	SHORT CHIP	0
FB2605	1-414-228-11	FERRITE	0 $\mu\text{H}$	R2635	1-216-809-11	METAL CHIP	100 5% 1/10W
FB2608	1-414-228-11	FERRITE	0 $\mu\text{H}$	R2636	1-216-809-11	METAL CHIP	100 5% 1/10W
FB2609	1-414-228-11	FERRITE	0 $\mu\text{H}$	R2639	1-216-797-11	METAL CHIP	10 5% 1/10W
FB2610	1-414-228-11	FERRITE	0 $\mu\text{H}$	R2642	1-216-853-11	METAL CHIP	470K 5% 1/10W
FB2611	1-414-228-11	FERRITE	0 $\mu\text{H}$	R2643	1-216-864-11	SHORT CHIP	0
				R2645	1-216-864-11	SHORT CHIP	0
				R2679	1-216-809-11	METAL CHIP	100 5% 1/10W
				R2680	1-216-839-11	METAL CHIP	33K 5% 1/10W
				R2681	1-216-829-11	METAL CHIP	4.7K 5% 1/10W
				R2682	1-216-830-11	METAL CHIP	5.6K 5% 1/10W

Les composants identifiés par une trame et une marque  $\Delta$  sont critiques pour la sécurité. Ne les remplacer que par une pièce portant le numéro spécifié.

The components identified by shading and mark  $\Delta$  are critical for safety. Replace only with part number specified.

KDS-R50XBR1/R60XBR1

RM-Y914

RM-Y914

**AK**

**F**

**G**

REF. NO.	PART NO.	DESCRIPTION	REMARK
R2696	1-216-833-11	METAL CHIP	10K 5% 1/10W
R2711	1-216-809-11	METAL CHIP	100 5% 1/10W
R2713	1-216-805-11	METAL CHIP	47 5% 1/10W
R2714	1-218-692-11	METAL CHIP	1K 0.5% 1/10W
R2715	1-218-704-11	METAL CHIP	3.3K 0.5% 1/10W
R2716	1-218-704-11	METAL CHIP	3.3K 0.5% 1/10W
R2717	1-216-864-11	SHORT CHIP	0
R2718	1-216-833-11	METAL CHIP	10K 5% 1/10W
R2719	1-216-864-11	SHORT CHIP	0
R2720	1-216-864-11	SHORT CHIP	0
R2721	1-216-864-11	SHORT CHIP	0
R2722	1-216-864-11	SHORT CHIP	0
R2723	1-216-864-11	SHORT CHIP	0
R2724	1-218-716-11	METAL CHIP	10K 0.5% 1/10W
R2725	1-218-714-11	METAL CHIP	8.2K 0.5% 1/10W
R2726	1-216-864-11	SHORT CHIP	0
R2730	1-216-864-11	SHORT CHIP	0
R2744	1-216-864-11	SHORT CHIP	0
R2745	1-216-864-11	SHORT CHIP	0
R2746	1-216-864-11	SHORT CHIP	0
R2763	1-216-864-11	SHORT CHIP	0
R2764	1-216-864-11	SHORT CHIP	0
R2765	1-216-864-11	SHORT CHIP	0
R2781	1-216-864-11	SHORT CHIP	0
R2789	1-216-864-11	SHORT CHIP	0
R2790	1-216-801-11	METAL CHIP	22 5% 1/10W
< TEST POINT >			
TP2600	1-535-757-11	CHIP, CHECKER	
TP2601	1-535-757-11	CHIP, CHECKER	
< VIBRATOR >			
X2600	1-813-049-21	VIBRATOR, CRYSTAL	
*****			
A-1119-915-A F BOARD, COMPLETE *****			
	1-533-223-11	FUSE HOLDER	0A 0V
< CAPACITOR >			
C6002	$\Delta$ 1-165-531-21	MYLAR	1 $\mu$ F 10 0V
C6004	$\Delta$ 1-165-529-31	MYLAR	0.22 $\mu$ F 10 0V
C6005	$\Delta$ 1-119-886-51	CERAMIC	470pF 10% 250V
C6006	$\Delta$ 1-119-886-51	CERAMIC	470pF 10% 250V
< CONNECTOR >			
CN6001*	1-580-843-11	PIN, CONNECTOR (POWER)	
CN6018*	1-580-843-11	PIN, CONNECTOR (POWER)	
CN6051	1-695-915-11	TAB (CONTACT)	
CN6052	1-695-915-11	TAB (CONTACT)	
CN6053	1-695-915-11	TAB (CONTACT)	
CN6054	1-695-915-11	TAB (CONTACT)	
< FUSE >			
F6001	$\Delta$ 1-576-233-51	FUSE	6.3A 250V

REF. NO.	PART NO.	DESCRIPTION	REMARK
< COIL >			
L6002	$\Delta$ 1-456-856-21	LINE FILTER COIL	
L6003	$\Delta$ 1-456-856-21	LINE FILTER COIL	
< RESISTOR >			
R6002	1-240-938-91	METAL	1.5M 5% 0.5W
R6063	1-240-938-91	METAL	1.5M 5% 0.5W
< VARISTOR >			
VD6001	$\Delta$ 1-804-995-21	VARISTOR	
VD6002	$\Delta$ 1-804-995-21	VARISTOR	
*****			
A-1138-898-A G BOARD, COMPLETE *****			
* 1-694-592-21 TERMINAL			
2-580-594-01 SCREW, +PSW M3X12			
* 4-042-408-02 PIN(45), WIRE			
< CAPACITOR >			
C6001	1-162-970-11	CERAMIC CHIP	0.01 $\mu$ F 10% 25V
C6002	1-162-974-11	CERAMIC CHIP	0.01 $\mu$ F 50V
C6008	1-165-531-31	MYLAR	1 $\mu$ F 10 0V
C6101	1-161-964-91	CERAMIC	0.0047 $\mu$ F 250V
C6102	1-161-964-91	CERAMIC	0.0047 $\mu$ F 250V
C6105	1-107-974-11	CERAMIC	47pF 5% 2KV
C6106	1-100-780-31	ELECT	22 $\mu$ F 20% 450V
C6107	1-165-127-11	CERAMIC	470pF 10% 500V
C6111	$\Delta$ 1-119-886-51	CERAMIC	470pF 10% 250V
C6113	1-165-729-31	ELECT	470 $\mu$ F 20% 16V
C6114	1-107-826-11	CERAMIC CHIP	0.1 $\mu$ F 10% 16V
C6115	1-128-526-11	ELECT	100 $\mu$ F 20% 25V
C6116	1-107-910-11	ELECT	100 $\mu$ F 20% 50V
C6117	1-107-905-11	ELECT	4.7 $\mu$ F 20% 50V
C6118	1-107-903-11	ELECT	2.2 $\mu$ F 20% 50V
C6119	1-162-964-11	CERAMIC CHIP	0.001 $\mu$ F 10% 50V
C6202	1-104-760-11	CERAMIC CHIP	0.047 $\mu$ F 10% 50V
C6203	1-161-964-91	CERAMIC	0.0047 $\mu$ F 250V
C6204	1-161-964-91	CERAMIC	0.0047 $\mu$ F 250V
C6205	1-163-037-11	CERAMIC CHIP	0.022 $\mu$ F 10% 50V
C6206	1-115-339-11	CERAMIC CHIP	0.1 $\mu$ F 10% 50V
C6207	1-163-021-91	CERAMIC CHIP	0.01 $\mu$ F 10% 50V
C6208	1-107-823-11	CERAMIC CHIP	0.47 $\mu$ F 10% 16V
C6209	1-161-964-91	CERAMIC	0.0047 $\mu$ F 250V
C6210	1-161-964-91	CERAMIC	0.0047 $\mu$ F 250V
C6212	1-112-024-21	MYLAR	1 $\mu$ F 10% 450V
C6213	1-162-927-11	CERAMIC CHIP	100pF 5% 50V
C6215	1-162-964-11	CERAMIC CHIP	0.001 $\mu$ F 10% 50V
C6216	1-163-021-91	CERAMIC CHIP	0.01 $\mu$ F 10% 50V
C6217	1-162-962-11	CERAMIC CHIP	470pF 10% 50V
C6218	$\Delta$ 1-119-886-51	CERAMIC	470pF 10% 250V
C6219	1-128-526-11	ELECT	100 $\mu$ F 20% 25V
C6220	1-163-037-11	CERAMIC CHIP	0.022 $\mu$ F 10% 50V
C6221	1-162-964-11	CERAMIC CHIP	0.001 $\mu$ F 10% 50V
C6222	1-107-889-11	ELECT	220 $\mu$ F 20% 25V
C6223	1-115-339-11	CERAMIC CHIP	0.1 $\mu$ F 10% 50V
C6225	1-163-021-91	CERAMIC CHIP	0.01 $\mu$ F 10% 50V
C6226	1-163-037-11	CERAMIC CHIP	0.022 $\mu$ F 10% 50V
C6227	1-115-339-11	CERAMIC CHIP	0.1 $\mu$ F 10% 50V
C6228	1-107-906-11	ELECT	10 $\mu$ F 20% 50V



REF. NO.	PART NO.	DESCRIPTION	REMARK	REF. NO.	PART NO.	DESCRIPTION	REMARK
C6229	1-115-416-11	CERAMIC CHIP	0.001μF 5% 25V	C6436	1-164-315-11	CERAMIC CHIP	470pF 5% 50V
C6230	1-104-760-11	CERAMIC CHIP	0.047μF 10% 50V	C6437	1-164-315-11	CERAMIC CHIP	470pF 5% 50V
C6231	1-100-613-81	CERAMIC	470pF 5% 1KV	C6438	1-164-315-11	CERAMIC CHIP	470pF 5% 50V
C6232	1-100-613-81	CERAMIC	470pF 5% 1KV	C6439	1-164-315-11	CERAMIC CHIP	470pF 5% 50V
C6233	1-163-145-00	CERAMIC CHIP	0.0015μF 5% 50V	C6442	1-164-315-11	CERAMIC CHIP	470pF 5% 50V
C6234	1-163-037-11	CERAMIC CHIP	0.022μF 10% 50V	C6443	1-128-954-11	ELECT	1000μF 20% 25V
C6235	1-163-021-91	CERAMIC CHIP	0.01μF 10% 50V	C6445	1-164-315-11	CERAMIC CHIP	470pF 5% 50V
C6236	1-100-613-81	CERAMIC	470pF 5% 1KV	C6446	1-164-315-11	CERAMIC CHIP	470pF 5% 50V
C6237	1-100-613-81	CERAMIC	470pF 5% 1KV	C6447	1-164-315-11	CERAMIC CHIP	470pF 5% 50V
C6238	1-117-753-11	ELECT(BLOCK)	470μF 20% 450V	C6448	1-164-315-11	CERAMIC CHIP	470pF 5% 50V
C6239	1-162-964-11	CERAMIC CHIP	0.001μF 10% 50V	C6449	1-164-315-11	CERAMIC CHIP	470pF 5% 50V
C6240	1-162-970-11	CERAMIC CHIP	0.01μF 10% 25V	C6450	1-164-315-11	CERAMIC CHIP	470pF 5% 50V
C6241	1-163-021-91	CERAMIC CHIP	0.01μF 10% 50V	C6451	1-164-315-11	CERAMIC CHIP	470pF 5% 50V
C6242	1-117-753-11	ELECT(BLOCK)	470μF 20% 450V	C6452	1-164-315-11	CERAMIC CHIP	470pF 5% 50V
C6243	1-162-964-11	CERAMIC CHIP	0.001μF 10% 50V	C6453	1-164-315-11	CERAMIC CHIP	470pF 5% 50V
C6244	1-162-970-11	CERAMIC CHIP	0.01μF 10% 25V	C6454	1-164-315-11	CERAMIC CHIP	470pF 5% 50V
C6245	1-163-021-91	CERAMIC CHIP	0.01μF 10% 50V	C6455	1-164-315-11	CERAMIC CHIP	470pF 5% 50V
C6246	1-163-021-91	CERAMIC CHIP	0.01μF 10% 50V	C6456	1-164-315-11	CERAMIC CHIP	470pF 5% 50V
C6247	1-107-905-11	ELECT	4.7μF 20% 50V	C6503	1-107-914-11	ELECT	1000μF 20% 50V
C6248	1-107-888-11	ELECT	47μF 20% 25V			< CONNECTOR >	
C6249	1-107-905-11	ELECT	4.7μF 20% 50V	CN6014*	1-580-843-11	PIN, CONNECTOR (POWER)	
C6250	1-162-970-11	CERAMIC CHIP	0.01μF 10% 25V	CN6015*	1-785-701-11	PIN, CONNECTOR (PC BOARD) 3P	
C6251	1-107-902-11	ELECT	1μF 20% 50V	CN6301	1-695-915-11	TAB (CONTACT)	
C6252	1-162-970-11	CERAMIC CHIP	0.01μF 10% 25V	CN6501*	1-793-660-11	PIN, CONNECTOR (PC BOARD) 3P	
C6253	1-107-910-11	ELECT	100μF 20% 50V			< DIODE >	
C6254	1-162-970-11	CERAMIC CHIP	0.01μF 10% 25V	D6001	8-719-081-97	DIODE	MMDL914T1
C6256	1-162-970-11	CERAMIC CHIP	0.01μF 10% 25V	D6021	8-719-081-97	DIODE	MMDL914T1
C6258	1-117-227-11	MYLAR	1μF 10% 450V	D6100	8-719-077-76	DIODE	D2SB60A-F04
C6259	1-117-227-11	MYLAR	1μF 10% 450V	D6101	8-719-036-94	DIODE	RD5.6SB-T1
C6260	1-163-021-91	CERAMIC CHIP	0.01μF 10% 50V	D6102	6-500-849-01	DIODE	ERA22-08KFLB
C6301	1-137-639-21	MYLAR	0.47μF 10% 450V	D6103	6-500-567-31	DIODE	10ERB20-TB3
C6302	1-162-970-11	CERAMIC CHIP	0.01μF 10% 25V	D6104	6-500-567-31	DIODE	10ERB20-TB3
C6304	1-107-905-11	ELECT	4.7μF 20% 50V	D6105	8-719-032-12	DIODE	D1NS6
C6305	1-107-909-11	ELECT	47μF 20% 50V	D6106	6-500-567-31	DIODE	10ERB20-TB3
C6306	1-100-831-91	CERAMIC CHIP	0.001μF 2% 50V	D6201	8-719-304-63	DIODE	RM11C
C6307	1-107-906-11	ELECT	10μF 20% 50V	D6202	8-719-056-84	DIODE	UDZ-TE-17-7.5B
C6308	1-115-339-11	CERAMIC CHIP	0.1μF 10% 50V	D6203	8-719-081-97	DIODE	MMDL914T1
C6309	1-162-964-11	CERAMIC CHIP	0.001μF 10% 50V	D6204	8-719-056-84	DIODE	UDZ-TE-17-7.5B
C6310	1-115-340-11	CERAMIC CHIP	0.22μF 10% 25V	D6205	8-719-054-89	DIODE	D15XB60
C6311	1-162-970-11	CERAMIC CHIP	0.01μF 10% 25V	D6206	8-719-081-97	DIODE	MMDL914T1
C6313	1-107-888-11	ELECT	47μF 20% 25V	D6207	6-500-137-01	DIODE	BAT54HT1
C6314	1-162-970-11	CERAMIC CHIP	0.01μF 10% 25V	D6208	8-719-304-63	DIODE	RM11C
C6315	1-107-910-11	ELECT	100μF 20% 50V	D6209	6-500-254-01	DIODE	MM3Z7V5T1
C6317	1-100-613-81	CERAMIC	470pF 5% 1KV	D6210	6-500-137-01	DIODE	BAT54HT1
C6318	1-100-919-11	FILM	0.027μF 3% 1KV	D6211	6-500-137-01	DIODE	BAT54HT1
C6319	1-162-970-11	CERAMIC CHIP	0.01μF 10% 25V	D6212	8-719-041-97	DIODE	MA113-(TX)
C6321	1-117-227-11	MYLAR	1μF 10% 450V	D6213	8-719-041-97	DIODE	MA113-(TX)
C6332	1-163-021-91	CERAMIC CHIP	0.01μF 10% 50V	D6214	6-501-043-01	DIODE	UMZ16NT106
C6405	1-128-954-11	ELECT	1000μF 20% 25V	D6215	6-501-043-01	DIODE	UMZ16NT106
C6406	1-165-176-11	CERAMIC CHIP	0.047μF 10% 16V	D6216	8-719-304-63	DIODE	RM11C
C6407	1-137-921-31	ELECT	1500μF 20% 10V	D6217	6-500-407-01	DIODE	SF20L60U-4015
C6408	1-135-362-31	ELECT	1500μF 20% 16V	D6218	8-719-081-97	DIODE	MMDL914T1
C6411	1-162-974-11	CERAMIC CHIP	0.01μF 50V	D6219	8-719-059-51	DIODE	MA3J142E0LSO
C6413	1-126-926-11	ELECT	1000μF 20% 10V	D6225	6-500-849-01	DIODE	ERA22-08KFLB
C6414	1-107-884-11	ELECT	1000μF 20% 16V	D6226	6-500-849-01	DIODE	ERA22-08KFLB
C6417	1-162-974-11	CERAMIC CHIP	0.01μF 50V	D6302	8-719-082-03	DIODE	MM3Z15VT1
C6423	1-164-315-11	CERAMIC CHIP	470pF 5% 50V	D6305	8-719-979-64	DIODE	UF4005/23
C6426	1-104-653-11	ELECT	220μF 20% 16V	D6306	6-501-043-01	DIODE	UMZ16NT106
C6427	1-126-934-11	ELECT	220μF 20% 16V	D6307	6-501-043-01	DIODE	UMZ16NT106
C6429	1-162-974-11	CERAMIC CHIP	0.01μF 50V	D6308	6-500-567-31	DIODE	10ERB20-TB3
C6430	1-162-974-11	CERAMIC CHIP	0.01μF 50V				
C6432	1-162-974-11	CERAMIC CHIP	0.01μF 50V				
C6433	1-162-974-11	CERAMIC CHIP	0.01μF 50V				
C6435	1-137-921-31	ELECT	1500μF 20% 10V				

Les composants identifiés par une trame et une marque  $\Delta$  sont critiques pour la sécurité. Ne les remplacer que par une pièce portant le numéro spécifié.

The components identified by shading and mark  $\Delta$  are critical for safety. Replace only with part number specified.

KDS-R50XBR1/R60XBR1

RM-Y914

RM-Y914



REF. NO.	PART NO.	DESCRIPTION	REMARK
D6309	8-719-081-67	DIODE M1FM3	
D6311	6-500-137-01	DIODE BAT54HT1	
D6312	8-719-080-69	DIODE M1FS4-4063	
D6401	8-719-510-09	DIODE D10SC6M	
D6406	8-719-510-09	DIODE D10SC6M	
D6407	8-719-060-88	DIODE D4SBS6	
D6408	8-719-510-09	DIODE D10SC6M	
D6410	8-719-510-09	DIODE D10SC6M	
D6416	6-500-551-01	DIODE MM3Z11VT1	
D6418	8-719-081-97	DIODE MMDL914T1	
D6501	8-719-510-73	DIODE S3L20UF4	
< FERRITE BEAD >			
FB6001 *	1-469-670-21	FERRITE	0 $\mu$ H
FB6002 *	1-469-670-21	FERRITE	0 $\mu$ H
FB6301	1-410-397-21	FERRITE	1.1 $\mu$ H
FB6401	1-410-397-21	FERRITE	1.1 $\mu$ H
FB6402	1-410-397-21	FERRITE	1.1 $\mu$ H
FB6403	1-410-397-21	FERRITE	1.1 $\mu$ H
FB6404	1-410-397-21	FERRITE	1.1 $\mu$ H
< IC >			
IC6101	6-600-279-01	IC STR-A6169	
IC6102	8-759-682-42	IC MM1431ATT	
IC6201	6-704-924-01	IC PQ12DZ5UJ00H	
IC6202	6-703-132-01	IC UC3854BN	
IC6203	8-759-058-50	IC XRA10324AF	
IC6204	8-759-321-95	IC HA17431PA	
IC6301	6-706-852-01	IC CXD9841M	
IC6401	8-759-653-07	IC PQ09RD21J00H	
IC6402	8-759-098-24	IC PQ30RV11J00H	
IC6405	8-759-682-42	IC MM1431ATT	
< COIL >			
L6101	1-414-934-21	INDUCTOR	10 $\mu$ H
L6202	1-416-489-11	INDUCTOR	143 $\mu$ H
L6203	1-456-531-11	INDUCTOR	58 $\mu$ H
L6204	1-456-531-11	INDUCTOR	58 $\mu$ H
L6301	1-406-667-11	INDUCTOR	220 $\mu$ H
L6302	1-406-977-21	INDUCTOR	100 $\mu$ H
L6401	1-406-971-21	INDUCTOR	10 $\mu$ H
L6402	1-406-971-21	INDUCTOR	10 $\mu$ H
L6407	1-412-525-31	INDUCTOR	10 $\mu$ H
L6501	1-412-519-11	INDUCTOR	3.3 $\mu$ H
L6502	1-412-537-31	INDUCTOR	100 $\mu$ H
< PHOTOCOUPLER >			
PH6101 $\Delta$	8-749-016-82	PHOTOCOUPLER PC123GY2J00F	
PH6201 $\Delta$	8-749-016-82	PHOTOCOUPLER PC123GY2J00F	
PH6202 $\Delta$	8-749-016-82	PHOTOCOUPLER PC123GY2J00F	
PH6203 $\Delta$	8-749-016-82	PHOTOCOUPLER PC123GY2J00F	
PH6301 $\Delta$	8-749-016-82	PHOTOCOUPLER PC123GY2J00F	
< TRANSISTOR >			
Q6001	8-729-023-22	TRANSISTOR 2SD2114K	
Q6201	8-729-907-00	TRANSISTOR DTC114EU	
Q6202	8-729-907-00	TRANSISTOR DTC114EU	
Q6203	8-729-820-86	TRANSISTOR 2SB1121-ST	
Q6204	8-729-905-35	TRANSISTOR 2SC4081-R	

REF. NO.	PART NO.	DESCRIPTION	REMARK
Q6205	8-729-807-17	TRANSISTOR 2SD1621-S	
Q6206	6-551-336-01	TRANSISTOR 2SK3934(LBS1SONY.Q	
Q6207	6-551-336-01	TRANSISTOR 2SK3934(LBS1SONY.Q	
Q6208	8-729-026-53	TRANSISTOR 2SA1576A-T106-QR	
Q6209	8-729-905-35	TRANSISTOR 2SC4081-R	
Q6210	8-729-905-35	TRANSISTOR 2SC4081-R	
Q6211	8-729-905-35	TRANSISTOR 2SC4081-R	
Q6212	8-729-905-35	TRANSISTOR 2SC4081-R	
Q6213	8-729-026-53	TRANSISTOR 2SA1576A-T106-QR	
Q6214	8-729-907-00	TRANSISTOR DTC114EU	
Q6215	8-729-905-35	TRANSISTOR 2SC4081-R	
Q6216	8-729-026-53	TRANSISTOR 2SA1576A-T106-QR	
Q6217	8-729-026-53	TRANSISTOR 2SA1576A-T106-QR	
Q6218	8-729-804-41	TRANSISTOR 2SB1122-S	
Q6219	8-729-040-89	TRANSISTOR 2SK1590-T1B	
Q6301	6-551-297-01	TRANSISTOR 2SK3568(LBS1SONY.Q	
Q6302	6-551-297-01	TRANSISTOR 2SK3568(LBS1SONY.Q	
Q6303	8-729-905-35	TRANSISTOR 2SC4081-R	
Q6304	8-729-026-53	TRANSISTOR 2SA1576A-T106-QR	
< RESISTOR >			
R6001	1-216-835-11	METAL CHIP	15K 5% 1/10W
R6002	1-216-829-11	METAL CHIP	4.7K 5% 1/10W
R6005	1-202-962-11	CEMENTED	3.3 5% 10W
R6006	1-202-962-11	CEMENTED	3.3 5% 10W
R6007	1-217-781-31	FUSIBLE	2.2 5% 5W
R6101	1-216-353-00	METAL OXIDE	2.2 5% 1W
R6102	1-249-381-11	CARBON	1 5% 1/4W
R6103	1-260-129-11	CARBON	330K 5% 1/2W
R6104	1-216-813-11	METAL CHIP	220 5% 1/10W
R6105	1-249-393-11	CARBON	10 5% 1/4W
R6106	1-249-385-11	CARBON	2.2 5% 1/4W
R6107	1-216-823-11	METAL CHIP	1.5K 5% 1/10W
R6108	1-216-817-11	METAL CHIP	470 5% 1/10W
R6109	1-216-839-11	METAL CHIP	33K 5% 1/10W
R6110	1-218-871-11	METAL CHIP	10K 0.5% 1/10W
R6111	1-216-864-11	SHORT CHIP	0
R6112	1-218-871-11	METAL CHIP	10K 0.5% 1/10W
R6113	1-208-830-11	METAL CHIP	100K 0.5% 1/10W
R6114	1-208-830-11	METAL CHIP	100K 0.5% 1/10W
R6115	1-208-830-11	METAL CHIP	100K 0.5% 1/10W
R6116	1-208-830-11	METAL CHIP	100K 0.5% 1/10W
R6117	1-208-830-11	METAL CHIP	100K 0.5% 1/10W
R6118	1-208-830-11	METAL CHIP	100K 0.5% 1/10W
R6119	1-208-830-11	METAL CHIP	100K 0.5% 1/10W
R6120	1-208-830-11	METAL CHIP	100K 0.5% 1/10W
R6121	1-208-830-11	METAL CHIP	100K 0.5% 1/10W
R6122	1-208-830-11	METAL CHIP	100K 0.5% 1/10W
R6123	1-208-830-11	METAL CHIP	100K 0.5% 1/10W
R6124	1-208-830-11	METAL CHIP	100K 0.5% 1/10W
R6125	1-216-841-11	METAL CHIP	47K 5% 1/10W
R6201	1-216-121-11	RES-CHIP	1M 5% 1/10W
R6202	1-216-857-11	METAL CHIP	1M 5% 1/10W
R6203	1-218-899-11	METAL CHIP	150K 0.5% 1/16W
R6204	1-245-470-21	METAL	220K 1% 1/4W
R6205	1-245-474-21	METAL	330K 1% 1/4W
R6206	1-245-474-21	METAL	330K 1% 1/4W
R6207	1-218-895-11	METAL CHIP	100K 0.5% 1/10W
R6208	1-245-470-21	METAL	220K 1% 1/4W
R6209	1-245-474-21	METAL	330K 1% 1/4W
R6210	1-245-474-21	METAL	330K 1% 1/4W
R6211	1-218-877-11	METAL CHIP	18K 0.5% 1/10W
R6212	1-245-470-21	METAL	220K 1% 1/4W



REF. NO.	PART NO.	DESCRIPTION		REMARK	REF. NO.	PART NO.	DESCRIPTION		REMARK
R6213	1-245-474-21	METAL	330K	1%	1/4W	R6277	1-216-797-11	METAL CHIP	10 5% 1/10W
R6214	1-245-474-21	METAL	330K	1%	1/4W	R6278	1-216-849-11	METAL CHIP	220K 5% 1/10W
R6215	1-216-121-11	RES-CHIP	1M	5%	1/10W	R6279	1-216-829-11	METAL CHIP	4.7K 5% 1/10W
R6216	1-216-825-11	METAL CHIP	2.2K	5%	1/10W	R6280	1-216-829-11	METAL CHIP	4.7K 5% 1/10W
R6217	1-218-847-11	METAL CHIP	1K	0.5%	1/10W	R6281	1-216-833-11	METAL CHIP	10K 5% 1/10W
R6218	1-218-875-11	METAL CHIP	15K	0.5%	1/10W	R6282	1-218-863-11	METAL CHIP	4.7K 0.5% 1/10W
R6219	1-216-857-11	METAL CHIP	1M	5%	1/10W	R6283	1-218-831-11	METAL CHIP	220 0.5% 1/10W
R6220	1-216-830-11	METAL CHIP	5.6K	5%	1/10W	R6284	1-218-855-11	METAL CHIP	2.2K 0.5% 1/10W
R6222	1-216-837-11	METAL CHIP	22K	5%	1/10W	R6285	1-216-833-11	METAL CHIP	10K 5% 1/10W
R6223	1-243-665-11	METAL	0.05	5%	5W	R6286	1-216-841-11	METAL CHIP	47K 5% 1/10W
R6224	1-243-665-11	METAL	0.05	5%	5W	R6287	1-216-833-11	METAL CHIP	10K 5% 1/10W
R6225	1-249-397-11	CARBON	22	5%	1/4W	R6288	1-216-833-11	METAL CHIP	10K 5% 1/10W
R6226	1-216-802-11	METAL CHIP	27	5%	1/10W	R6289	1-216-833-11	METAL CHIP	10K 5% 1/10W
R6227	1-216-825-11	METAL CHIP	2.2K	5%	1/10W	R6290	1-216-841-11	METAL CHIP	47K 5% 1/10W
R6228	1-216-837-11	METAL CHIP	22K	5%	1/10W	R6291	1-216-833-11	METAL CHIP	10K 5% 1/10W
R6229	1-249-397-11	CARBON	22	5%	1/4W	R6292	1-249-393-11	CARBON	10 5% 1/4W
R6230	1-216-833-11	METAL CHIP	10K	5%	1/10W	R6293	1-216-837-11	METAL CHIP	22K 5% 1/10W
R6231	1-216-802-11	METAL CHIP	27	5%	1/10W	R6294	1-216-833-11	METAL CHIP	10K 5% 1/10W
R6232	1-216-833-11	METAL CHIP	10K	5%	1/10W	R6297	1-216-827-11	METAL CHIP	3.3K 5% 1/10W
R6233	1-249-393-11	CARBON	10	5%	1/4W	R6298	1-216-825-11	METAL CHIP	2.2K 5% 1/10W
R6234	1-249-401-11	CARBON	47	5%	1/4W	R6299	1-216-861-11	METAL CHIP	2.2M 5% 1/10W
R6235	1-216-833-11	METAL CHIP	10K	5%	1/10W	R6301	1-249-393-11	CARBON	10 5% 1/4W
R6236	1-216-837-11	METAL CHIP	22K	5%	1/10W	R6302	1-202-933-61	FUSIBLE	0.1 10% 1/2W
R6237	1-249-393-11	CARBON	10	5%	1/4W	R6303	1-218-865-11	METAL CHIP	5.6K 0.5% 1/10W
R6238	1-216-829-11	METAL CHIP	4.7K	5%	1/10W	R6304	1-216-833-11	METAL CHIP	10K 5% 1/10W
R6239	1-216-849-11	METAL CHIP	220K	5%	1/10W	R6305	1-245-478-21	METAL	470K 1% 1/4W
R6240	1-216-833-11	METAL CHIP	10K	5%	1/10W	R6306	1-245-478-21	METAL	470K 1% 1/4W
R6241	1-216-837-11	METAL CHIP	22K	5%	1/10W	R6307	1-218-877-11	METAL CHIP	18K 0.5% 1/10W
R6242	1-216-829-11	METAL CHIP	4.7K	5%	1/10W	R6308	1-216-821-11	METAL CHIP	1K 5% 1/10W
R6243	1-216-833-11	METAL CHIP	10K	5%	1/10W	R6309	1-218-823-11	METAL CHIP	100 0.5% 1/10W
R6244	1-218-867-11	METAL CHIP	6.8K	0.5%	1/10W	R6311	1-219-230-71	FUSIBLE	22 5% 1/6W
R6245	1-218-851-11	METAL CHIP	1.5K	0.5%	1/10W	R6312	1-219-230-71	FUSIBLE	22 5% 1/6W
R6246	1-218-869-11	METAL CHIP	8.2K	0.5%	1/10W	R6313	1-218-825-11	METAL CHIP	120 0.5% 1/10W
R6247	1-208-830-11	METAL CHIP	100K	0.5%	1/10W	R6314	1-216-833-11	METAL CHIP	10K 5% 1/10W
R6248	1-208-830-11	METAL CHIP	100K	0.5%	1/10W	R6315	1-216-833-11	METAL CHIP	10K 5% 1/10W
R6249	1-208-830-11	METAL CHIP	100K	0.5%	1/10W	R6316	1-260-304-51	CARBON	10 5% 1/2W
R6250	1-216-845-11	METAL CHIP	100K	5%	1/10W	R6317	1-216-833-11	METAL CHIP	10K 5% 1/10W
R6251	1-216-835-11	METAL CHIP	15K	5%	1/10W	R6318	1-216-361-00	METAL OXIDE	0.22 5% 2W
R6252	1-216-837-11	METAL CHIP	22K	5%	1/10W	R6319	1-216-821-11	METAL CHIP	1K 5% 1/10W
R6253	1-215-882-00	METAL OXIDE	22	5%	2W	R6321	1-216-833-11	METAL CHIP	10K 5% 1/10W
R6254	1-215-882-00	METAL OXIDE	22	5%	2W	R6322	1-202-933-61	FUSIBLE	0.1 10% 1/2W
R6255	1-216-121-11	RES-CHIP	1M	5%	1/10W	R6325	1-216-864-11	SHORT CHIP	0
R6256	1-216-833-11	METAL CHIP	10K	5%	1/10W	R6341	1-216-857-11	METAL CHIP	1M 5% 1/10W
R6257	1-216-821-11	METAL CHIP	1K	5%	1/10W	R6402	1-216-821-11	METAL CHIP	1K 5% 1/10W
R6258	1-216-841-11	METAL CHIP	47K	5%	1/10W	R6403	1-216-864-11	SHORT CHIP	0
R6259	1-216-833-11	METAL CHIP	10K	5%	1/10W	R6404	1-216-821-11	METAL CHIP	1K 5% 1/10W
R6260	1-216-833-11	METAL CHIP	10K	5%	1/10W	R6406	1-216-793-11	METAL CHIP	4.7 5% 1/10W
R6261	1-216-809-11	METAL CHIP	100	5%	1/10W	R6407	1-216-821-11	METAL CHIP	1K 5% 1/10W
R6262	1-208-830-11	METAL CHIP	100K	0.5%	1/10W	R6411	1-218-863-11	METAL CHIP	4.7K 0.5% 1/10W
R6263	1-208-830-11	METAL CHIP	100K	0.5%	1/10W	R6412	1-218-875-11	METAL CHIP	15K 0.5% 1/10W
R6264	1-208-830-11	METAL CHIP	100K	0.5%	1/10W	R6413	1-216-864-11	SHORT CHIP	0
R6265	1-216-837-11	METAL CHIP	22K	5%	1/10W	R6414	1-216-841-11	METAL CHIP	47K 5% 1/10W
R6266	1-216-847-11	METAL CHIP	150K	5%	1/10W	R6415	1-218-847-11	METAL CHIP	1K 0.5% 1/10W
R6267	1-216-833-11	METAL CHIP	10K	5%	1/10W	R6416	1-218-847-11	METAL CHIP	1K 0.5% 1/10W
R6268	1-216-821-11	METAL CHIP	1K	5%	1/10W	R6417	1-218-855-11	METAL CHIP	2.2K 0.5% 1/10W
R6269	1-216-821-11	METAL CHIP	1K	5%	1/10W	R6423	1-216-833-11	METAL CHIP	10K 5% 1/10W
R6270	1-216-821-11	METAL CHIP	1K	5%	1/10W	R6426	1-216-864-11	SHORT CHIP	0
R6271	1-216-841-11	METAL CHIP	47K	5%	1/10W	R6427	1-216-864-11	SHORT CHIP	0
R6272	1-216-833-11	METAL CHIP	10K	5%	1/10W	R6428	1-216-864-11	SHORT CHIP	0
R6273	1-216-821-11	METAL CHIP	1K	5%	1/10W	R6450	1-216-821-11	METAL CHIP	1K 5% 1/10W
R6274	1-216-829-11	METAL CHIP	4.7K	5%	1/10W	R6454	1-216-833-11	METAL CHIP	10K 5% 1/10W
R6275	1-216-829-11	METAL CHIP	4.7K	5%	1/10W	R6455	1-216-864-11	SHORT CHIP	0
R6276	1-216-841-11	METAL CHIP	47K	5%	1/10W	R6601	1-216-821-11	METAL CHIP	1K 5% 1/10W
						R6602	1-216-817-11	METAL CHIP	470 5% 1/10W

Les composants identifiés par une trame et une marque  $\Delta$  sont critiques pour la sécurité. Ne les remplacer que par une pièce portant le numéro spécifié.

The components identified by shading and mark  $\Delta$  are critical for safety. Replace only with part number specified.

KDS-R50XBR1/R60XBR1

RM-Y914

RM-Y914



REF. NO.	PART NO.	DESCRIPTION	REMARK
R6603	1-216-864-11	SHORT CHIP	0
< VARIABLE RESISTOR >			
RV6201	1-225-626-91	RES, VAR, ADJ, CERMET 1K	
< RELAY >			
R6001 $\Delta$	1-755-418-12	RELAY (AC POWER)	
R6002 $\Delta$	1-755-418-12	RELAY (AC POWER)	
< TRANSFORMER >			
T6101 $\Delta$	1-443-313-21	TRANSFORMER, CONVERTER (SBT)	
T6302 $\Delta$	1-443-797-11	DC-DC CONVERTER TRANSFORMER	
< THERMISTOR >			
TH6101	1-803-586-11	THERMISTOR, NTC	
TH6201	1-809-789-71	THERMISTOR, POSITIVE	
*****			
A-1060-186-A HM BOARD, COMPLETE			
*****			
< CAPACITOR >			
C7203	1-162-910-11	CERAMIC CHIP	5pF 0.25PF 50V
C7203	1-162-910-11	CERAMIC CHIP	5pF 0.25PF 50V
C7204	1-162-911-11	CERAMIC CHIP	6pF 0.50PF 50V
C7204	1-162-911-11	CERAMIC CHIP	6pF 0.50PF 50V
C7205	1-162-970-11	CERAMIC CHIP	0.01 $\mu$ F 10% 25V
C7205	1-162-970-11	CERAMIC CHIP	0.01 $\mu$ F 10% 25V
C7206	1-162-970-11	CERAMIC CHIP	0.01 $\mu$ F 10% 25V
C7206	1-162-970-11	CERAMIC CHIP	0.01 $\mu$ F 10% 25V
C7207	1-107-826-11	CERAMIC CHIP	0.1 $\mu$ F 10% 16V
C7207	1-107-826-11	CERAMIC CHIP	0.1 $\mu$ F 10% 16V
C7208	1-162-970-11	CERAMIC CHIP	0.01 $\mu$ F 10% 25V
C7208	1-162-970-11	CERAMIC CHIP	0.01 $\mu$ F 10% 25V
C7209	1-125-837-91	CERAMIC CHIP	1 $\mu$ F 10% 6.3V
C7209	1-125-837-91	CERAMIC CHIP	1 $\mu$ F 10% 6.3V
C7210	1-107-826-11	CERAMIC CHIP	0.1 $\mu$ F 10% 16V
C7211	1-127-760-11	CERAMIC CHIP	4.7 $\mu$ F 10% 6.3V
C7211	1-127-760-11	CERAMIC CHIP	4.7 $\mu$ F 10% 6.3V
C7212	1-125-837-91	CERAMIC CHIP	1 $\mu$ F 10% 6.3V
C7212	1-125-837-91	CERAMIC CHIP	1 $\mu$ F 10% 6.3V
C7213	1-162-970-11	CERAMIC CHIP	0.01 $\mu$ F 10% 25V
C7213	1-162-970-11	CERAMIC CHIP	0.01 $\mu$ F 10% 25V
C7215	1-164-156-11	CERAMIC CHIP	0.1 $\mu$ F 25V
C7215	1-164-156-11	CERAMIC CHIP	0.1 $\mu$ F 25V
C7216	1-162-970-11	CERAMIC CHIP	0.01 $\mu$ F 10% 25V
C7216	1-162-970-11	CERAMIC CHIP	0.01 $\mu$ F 10% 25V
C7217	1-125-837-91	CERAMIC CHIP	1 $\mu$ F 10% 6.3V
C7217	1-125-837-91	CERAMIC CHIP	1 $\mu$ F 10% 6.3V
C7218	1-164-156-11	CERAMIC CHIP	0.1 $\mu$ F 25V
C7218	1-164-156-11	CERAMIC CHIP	0.1 $\mu$ F 25V
C7219	1-164-156-11	CERAMIC CHIP	0.1 $\mu$ F 25V
C7219	1-164-156-11	CERAMIC CHIP	0.1 $\mu$ F 25V
C7220	1-164-156-11	CERAMIC CHIP	0.1 $\mu$ F 25V
C7220	1-164-156-11	CERAMIC CHIP	0.1 $\mu$ F 25V
C7221	1-164-156-11	CERAMIC CHIP	0.1 $\mu$ F 25V
C7221	1-164-156-11	CERAMIC CHIP	0.1 $\mu$ F 25V

REF. NO.	PART NO.	DESCRIPTION	REMARK
C7224	1-164-156-11	CERAMIC CHIP	0.1 $\mu$ F 25V
C7224	1-164-156-11	CERAMIC CHIP	0.1 $\mu$ F 25V
< CONNECTOR >			
CN7201	1-779-677-11	CONNECTOR, USB (B)	
CN7204	1-817-653-11	MEMORY STICK CONNECTOR	
< DIODE >			
D7201	8-719-800-76	DIODE 1SS226	
D7202	8-719-056-77	DIODE UDZ-TE-17-3.9B	
D7210	6-500-182-01	DIODE L-1503CB/1ID-F01	
D7212	8-719-056-77	DIODE UDZ-TE-17-3.9B	
< FERRITE BEAD >			
FB7201	1-414-921-11	FERRITE	0 $\mu$ H
FB7202	1-414-921-11	FERRITE	0 $\mu$ H
FB7203	1-414-921-11	FERRITE	0 $\mu$ H
< IC >			
IC7201	6-703-076-01	IC XC6204B332MR	
IC7202	6-704-548-01	IC 90C36LC1B-LF	
IC7203	6-704-067-01	IC M24128-BWMN6T(A)	
< COIL >			
L7201	1-414-394-11	INDUCTOR	2.2 $\mu$ H
< TRANSISTOR >			
Q7201	8-729-424-02	TRANSISTOR 2SB709A-QRS-TX	
Q7202	8-729-422-27	TRANSISTOR 2SD601A-Q	
< RESISTOR >			
R7201	1-216-864-11	SHORT CHIP	0
R7202	1-414-228-11	FERRITE	0 $\mu$ H
R7203	1-216-837-11	METAL CHIP	22K 5% 1/10W
R7204	1-216-809-11	METAL CHIP	100 5% 1/10W
R7206	1-216-857-11	METAL CHIP	1M 5% 1/10W
R7209	1-414-228-11	FERRITE	0 $\mu$ H
R7210	1-216-803-11	METAL CHIP	33 5% 1/10W
R7211	1-216-821-11	METAL CHIP	1K 5% 1/10W
R7212	1-216-803-11	METAL CHIP	33 5% 1/10W
R7214	1-216-823-11	METAL CHIP	1.5K 5% 1/10W
R7215	1-414-228-11	FERRITE	0 $\mu$ H
R7216	1-216-821-11	METAL CHIP	1K 5% 1/10W
R7217	1-216-821-11	METAL CHIP	1K 5% 1/10W
R7218	1-216-829-11	METAL CHIP	4.7K 5% 1/10W
R7219	1-216-817-11	METAL CHIP	470 5% 1/10W
R7221	1-216-821-11	METAL CHIP	1K 5% 1/10W
R7222	1-216-811-11	METAL CHIP	150 5% 1/10W
R7223	1-216-809-11	METAL CHIP	100 5% 1/10W
R7224	1-216-809-11	METAL CHIP	100 5% 1/10W
R7225	1-216-809-11	METAL CHIP	100 5% 1/10W
R7226	1-216-864-11	SHORT CHIP	0
R7227	1-216-864-11	SHORT CHIP	0
R7228	1-216-864-11	SHORT CHIP	0
R7229	1-216-821-11	METAL CHIP	1K 5% 1/10W
R7231	1-216-825-11	METAL CHIP	2.2K 5% 1/10W
R7234	1-216-809-11	METAL CHIP	100 5% 1/10W

**HM**

**H1**

**H2**

**H3**

REF. NO.	PART NO.	DESCRIPTION	REMARK
		< VIBRATOR >	
X7201	1-760-965-21	VIBRATOR, CRYSTAL	
*****			
	A-1123-100-A	H1 BOARD, COMPLETE	
		*****	
		< CAPACITOR >	
C7000	1-100-597-91	CERAMIC CHIP 0.1μF	10% 25V
		< DIODE >	
D7001	8-719-083-58	DIODE UDZSTE-173.9B	
		< RESISTOR >	
R7001	1-218-684-11	METAL CHIP 470	0.5% 1/10W
R7002	1-218-688-11	METAL CHIP 680	0.5% 1/10W
R7003	1-218-692-11	METAL CHIP 1K	0.5% 1/10W
R7004	1-218-700-11	METAL CHIP 2.2K	0.5% 1/10W
R7005	1-218-708-11	METAL CHIP 4.7K	0.5% 1/10W
		< SWITCH >	
S7000	1-762-196-21	SWITCH, TACT	
S7001	1-762-196-21	SWITCH, TACT	
S7002	1-762-196-21	SWITCH, TACT	
S7003	1-762-196-21	SWITCH, TACT	
S7004	1-762-196-21	SWITCH, TACT	
S7005	1-762-196-21	SWITCH, TACT	
*****			
	A-1123-101-A	H2 BOARD, COMPLETE	
		*****	
		< CAPACITOR >	
C7020	1-164-156-11	CERAMIC CHIP 0.1μF	25V
C7021	1-124-779-00	ELECT CHIP 10μF	20% 16V
C7022	1-162-974-11	CERAMIC CHIP 0.01μF	50V
C7023	1-162-974-11	CERAMIC CHIP 0.01μF	50V
C7024	1-162-974-11	CERAMIC CHIP 0.01μF	50V
C7025	1-164-156-11	CERAMIC CHIP 0.1μF	25V
C7026	1-162-974-11	CERAMIC CHIP 0.01μF	50V
C7027	1-162-974-11	CERAMIC CHIP 0.01μF	50V
C7029	1-164-156-11	CERAMIC CHIP 0.1μF	25V
C7030	1-128-993-21	ELECT CHIP 22μF	20% 10V
C7031	1-164-156-11	CERAMIC CHIP 0.1μF	25V
C7032	1-162-974-11	CERAMIC CHIP 0.01μF	50V
C7033	1-128-993-21	ELECT CHIP 22μF	20% 10V
C7034	1-164-156-11	CERAMIC CHIP 0.1μF	25V
		< DIODE >	
D7022	6-500-861-01	DIODE SML-020MVT-T86	
D7023	8-719-064-07	DIODE SML-310LTT86	
D7024	6-500-861-01	DIODE SML-020MVT-T86	
D7025	8-719-158-19	DIODE RD6.2SB	
D7026	8-719-158-19	DIODE RD6.2SB	

REF. NO.	PART NO.	DESCRIPTION	REMARK
		< IC >	
IC7020	6-703-744-01	IC GP1UE26SXKOF	
IC7021	6-706-481-01	IC TC7SET32FU(T5RSOJF)	
IC7022	8-759-695-94	IC TAR5S33(TE85R)	
		< COIL >	
L7000	1-469-555-21	INDUCTOR 10μH	
		< TRANSISTOR >	
Q7020	8-729-120-28	TRANSISTOR 2SC1623-L5L6	
Q7021	8-729-120-28	TRANSISTOR 2SC1623-L5L6	
Q7022	8-729-120-28	TRANSISTOR 2SC1623-L5L6	
Q7023	8-729-120-28	TRANSISTOR 2SC1623-L5L6	
		< RESISTOR >	
R7020	1-216-823-11	METAL CHIP 1.5K	5% 1/10W
R7021	1-216-864-11	SHORT CHIP 0	
R7022	1-216-833-11	METAL CHIP 10K	5% 1/10W
R7023	1-216-833-11	METAL CHIP 10K	5% 1/10W
R7024	1-216-817-11	METAL CHIP 470	5% 1/10W
R7025	1-216-817-11	METAL CHIP 470	5% 1/10W
R7026	1-216-833-11	METAL CHIP 10K	5% 1/10W
R7027	1-216-833-11	METAL CHIP 10K	5% 1/10W
R7028	1-216-817-11	METAL CHIP 470	5% 1/10W
R7029	1-216-833-11	METAL CHIP 10K	5% 1/10W
R7030	1-216-833-11	METAL CHIP 10K	5% 1/10W
R7031	1-216-833-11	METAL CHIP 10K	5% 1/10W
R7032	1-216-817-11	METAL CHIP 470	5% 1/10W
R7036	1-216-805-11	METAL CHIP 47	5% 1/10W
R7039	1-216-833-11	METAL CHIP 10K	5% 1/10W
R7041	1-216-853-11	METAL CHIP 470K	5% 1/10W
		< SWITCH >	
S7020	1-762-196-21	SWITCH, TACT	
*****			
	A-1123-102-A	H3 BOARD, COMPLETE	
		*****	
		< CAPACITOR >	
C7057	1-128-991-21	ELECT CHIP 10μF	20% 50V
C7058	1-128-991-21	ELECT CHIP 10μF	20% 50V
C7059	1-125-891-11	CERAMIC CHIP 0.47μF	10% 10V
C7060	1-126-603-11	ELECT CHIP 4.7μF	20% 35V
C7061	1-126-603-11	ELECT CHIP 4.7μF	20% 35V
		< CONNECTOR >	
CN7050	1-784-646-11	TERMINAL, S	
CN7051	1-695-915-11	TAB (CONTACT)	
		< DIODE >	
D7050	8-719-977-28	DIODE DTZ10B	
D7051	8-719-977-28	DIODE DTZ10B	
D7052	8-719-977-28	DIODE DTZ10B	

Les composants identifiés par une trame et une marque  $\Delta$  sont critiqués pour la sécurité. Ne les remplacer que par une pièce portant le numéro spécifié.

The components identified by shading and mark  $\Delta$  are critical for safety. Replace only with part number specified.

KDS-R50XBR1/R60XBR1

RM-Y914

RM-Y914

**H3**

**QU**

**S1**

**S2**

**T1**

**T3**

REF. NO.	PART NO.	DESCRIPTION	REMARK
		< JACK >	
J7050	1-819-646-11	PHONO JACK 3P	
		< RESISTOR >	
R7050	1-216-864-11	SHORT CHIP	0
R7051	1-216-864-11	SHORT CHIP	0
R7052	1-216-864-11	SHORT CHIP	0
R7053	1-216-813-11	METAL CHIP	220 5% 1/10W
R7054	1-216-851-11	METAL CHIP	330K 5% 1/10W
R7055	1-216-851-11	METAL CHIP	330K 5% 1/10W
R7056	1-216-813-11	METAL CHIP	220 5% 1/10W
R7057	1-216-813-11	METAL CHIP	220 5% 1/10W
R7058	1-216-813-11	METAL CHIP	220 5% 1/10W
R7059	1-216-813-11	METAL CHIP	220 5% 1/10W
R7060	1-216-813-11	METAL CHIP	220 5% 1/10W
R7061	1-216-864-11	SHORT CHIP	0
R7062	1-216-813-11	METAL CHIP	220 5% 1/10W
R7063	1-216-813-11	METAL CHIP	220 5% 1/10W
R7064	1-216-813-11	METAL CHIP	220 5% 1/10W
		< VARISTOR >	
VD7051	1-803-974-21	VARISTOR, CHIP (1608)	
VD7052	1-803-974-21	VARISTOR, CHIP (1608)	
VD7053	1-803-974-21	VARISTOR, CHIP (1608)	
*****			
		* A-1073-391-A QU BOARD, COMPLETE	
		*****	
		< CAPACITOR >	
C7951	1-115-156-11	CERAMIC CHIP	1 $\mu$ F 10V
C7952	1-115-156-11	CERAMIC CHIP	1 $\mu$ F 10V
C7953	1-164-156-11	CERAMIC CHIP	0.1 $\mu$ F 25V
C7954	1-164-156-11	CERAMIC CHIP	0.1 $\mu$ F 25V
		< CONNECTOR >	
CN7951*	1-573-768-21	PIN, CONNECTOR (1.5mm) (SMD)5P	
CN7952*	1-818-486-11	PCMCIA CONNECTOR (SMD)	
CN7953*	1-818-483-11	FFC/FPC CONNECTOR (ZIF) 80P	
		< TEST POINT >	
TP7950	1-694-766-21	TERMINAL (ONBOARD CONTACT)	
*****			
		A-1123-098-A S1 BOARD, COMPLETE	
		*****	
		< CAPACITOR >	
C7100	1-164-156-11	CERAMIC CHIP	0.1 $\mu$ F 25V
C7101	1-165-908-11	CERAMIC CHIP	1 $\mu$ F 10% 10V
C7102	1-162-915-11	CERAMIC CHIP	10pF 0.50PF 50V
C7103	1-162-915-11	CERAMIC CHIP	10pF 0.50PF 50V
		< IC >	
IC7100	6-707-223-01	IC LM75BIM-5/NOPB	

REF. NO.	PART NO.	DESCRIPTION	REMARK
		< RESISTOR >	
R7101	1-216-801-11	METAL CHIP	22 5% 1/10W
R7102	1-216-801-11	METAL CHIP	22 5% 1/10W
R7104	1-216-864-11	SHORT CHIP	0
R7106	1-216-864-11	SHORT CHIP	0
R7108	1-216-864-11	SHORT CHIP	0
*****			
		A-1123-099-A S2 BOARD, COMPLETE	
		*****	
		< CAPACITOR >	
C7120	1-164-156-11	CERAMIC CHIP	0.1 $\mu$ F 25V
C7121	1-165-908-11	CERAMIC CHIP	1 $\mu$ F 10% 10V
C7122	1-162-915-11	CERAMIC CHIP	10pF 0.50PF 50V
C7123	1-162-915-11	CERAMIC CHIP	10pF 0.50PF 50V
		< IC >	
IC7120	6-707-223-01	IC LM75BIM-5/NOPB	
		< RESISTOR >	
R7121	1-216-801-11	METAL CHIP	22 5% 1/10W
R7122	1-216-801-11	METAL CHIP	22 5% 1/10W
R7124	1-216-864-11	SHORT CHIP	0
R7125	1-216-864-11	SHORT CHIP	0
R7126	1-216-864-11	SHORT CHIP	0
*****			
		A-1123-096-A T1 BOARD, COMPLETE	
		*****	
		< SWITCH >	
S7150	1-786-591-11	SWITCH, MICRO	
*****			
		A-1144-528-A T3 BOARD, COMPLETE	
		*****	
		< SWITCH >	
S7156	1-786-591-11	SWITCH, MICRO	
*****			
		MISCELLANEOUS	
		*****	
		$\Delta$ A-1127-174-A BLOCK ASSY, OPTICS	(R60XBR1)
		$\Delta$ A-1148-155-A BLOCK ASSY, OPTICS	(R50XBR1)
		$\Delta$ 1-468-936-11 POWER SUPPLY BLOCK	
		$\Delta$ 1-576-885-11 THERMOSTAT	
		$\Delta$ 1-787-333-11 D.C. FAN	
		$\Delta$ 1-791-192-13 CORD, NOISE FILTER WITH POWER	
		1-826-236-11 SPEAKER UNIT	
		1-826-237-11 SPEAKER UNIT	
		1-829-702-11 COAXIAL CABLE WITH F-PLUG	
		1-829-794-51 CORD WITH CONNECTOR	
		1-830-193-11 CABLE, USB	
		1-830-407-11 RF CABLE	
		1-830-856-11 FLEXIBLE FLAT CABLE	
		1-830-878-11 LEAD WIRE WITH CONNECTOR(LVDS)	



Les composants identifiés par une trame et une marque  $\triangle$  sont critiques pour la sécurité. Ne les remplacer que par une pièce portant le numéro spécifié.

The components identified by shading and mark  $\triangle$  are critical for safety. Replace only with part number specified.

REF. NO.	PART NO.	DESCRIPTION	REMARK
	1-830-900-11	LEAD WIRE WITH CONNECTOR(LVDS)	
	8-597-906-00	ANTENNA SWITCHE RFD-SA801	
	$\triangle$ 8-835-859-11	MOTOR, DC SFF22A/C-NP	
	$\triangle$ 8-835-860-11	MOTOR, DC SFF21C/C-NP	

\*\*\*\*\*

ACCESSORIES & PACKING MATERIALS

\*\*\*\*\*

* 2-581-446-11	BAG, PROTECTION	(R60XBR1)
* 2-587-561-01	SHEET, PROTECTION	(R60XBR1)
2-637-151-11	MANUAL, INSTRUCTION (US)	(R60XBR1)
2-637-152-11	QSG (US)	(R60XBR1)
2-637-710-11	MANUAL, INSTRUCTION (US)	(R50XBR1)
2-637-710-21	MANUAL, INSTRUCTION (FR)	(R50XBR1)
2-637-710-31	MANUAL, INSTRUCTION (ES)	(R50XBR1)
2-637-711-11	QSG (US)	(R50XBR1)
2-637-711-21	QSG (FR)	(R50XBR1)
2-637-711-31	QSG (ES)	(R50XBR1)
* 4-030-895-01	JOINT	(R60XBR1)
* 4-097-659-01	BAG, PROTECTION	(R60XBR1)
* 4-097-660-01	SHEET, PROTECTION	(R60XBR1)

< REMOTE COMMANDER >

1-478-337-11	REMOTE COMMANDER (RM-Y914)
--------------	----------------------------

< OPTIONAL ACCESSORIES >

93-0876-00	LAMP XL-5100
------------	--------------

# SXRD

Silicon X-tal Reflective Display

## SXRD Projection TV Operating Instructions

**KDS-R50XBR1**  
**KDS-R60XBR1**

**S-master**  
Digital Amplifier



### **Owner's Record**

The model and serial numbers are located at the rear of the TV. Record these numbers in the spaces provided below. Refer to them whenever you call upon your Sony dealer regarding this product.

Model No. \_\_\_\_\_

Serial No. \_\_\_\_\_

### **Contacting Sony**

If, after reading the following instructions, you have additional questions related to the use of your Sony® TV, please call one of the following numbers.

Customers in the continental United States contact the Direct Response Center at:

1-800-222-SONY (7669)

or visit <http://www.sonystyle.com/tv/>

Customers in Canada contact the Customer Relations Center at:

1-877-899-SONY (7669)

or visit <http://www.sonystyle.ca/tv/>

## WARNING

To reduce the risk of fire or electric shock, do not expose this apparatus to rain or moisture.



This symbol is intended to alert the user to the presence of uninsulated "dangerous voltage" within the product's enclosure that may be of sufficient magnitude to constitute a risk of electric shock to persons.



This symbol is intended to alert the user to the presence of important operating and maintenance (servicing) instructions in the literature accompanying the appliance.

The apparatus shall not be exposed to dripping or splashing and no objects filled with liquids, such as vases, shall be placed on the apparatus.

## CAUTION

To prevent electric shock, do not use this polarized AC plug with an extension cord, receptacle or other outlet unless the blades can be fully inserted to prevent blade exposure.

## CAUTION

When using TV games, computers, and similar products with your projection TV, keep the brightness and contrast functions at low settings. If a fixed (non-moving) pattern is left on the screen for long periods of time at a high brightness or contrast setting, the image can be permanently imprinted onto the screen. Continuously watching the same program can cause the imprint of station logos onto the TV screen. These types of imprints are not covered by your warranty because they are the result of misuse.

## Note on Caption Vision

This TV provides display of TV closed captioning in accordance with §15.119 of the FCC rules.

### For Customers in the United States

If you have any questions about this product, you may call; Sony Customer Information Services Center 1-800-222-7669 or <http://www.sony.com/>

## Declaration of Conformity

Trade Name: SONY  
Model: KDS-R50XBR1/KDS-R60XBR1  
Responsible Party: Sony Electronics Inc.  
Address: 16450 W. Bernardo Dr.,  
San Diego, CA 92127 U.S.A.  
Telephone Number: 858-942-2230

This device complies with part 15 of the FCC rules. Operation is subject to the following two conditions: (1) This device may not cause harmful interference, and (2) this device must accept any interference received, including interference that may cause undesired operation.

## NOTIFICATION

This equipment has been tested and found to comply with the limits for a Class B digital device, pursuant to Part 15 of the FCC Rules. These limits are designed to provide reasonable protection against harmful interference in a residential installation. This equipment generates, uses and can radiate radio frequency energy and, if not installed and used in accordance with the instructions, may cause harmful interference to radio communications. However, there is no guarantee that interference will not occur in a particular installation. If this equipment does cause harmful interference to radio or television reception, which can be determined by turning the equipment off and on, the user is encouraged to try to correct the interference by one or more of the following measures:

- Reorient or relocate the receiving antenna.
- Increase the separation between the equipment and receiver.
- Connect the equipment into an outlet on a circuit different from that to which the receiver is connected.
- Consult the dealer or an experienced radio/TV technician for help.

You are cautioned that any changes or modifications not expressly approved in this manual could void your authority to operate this equipment.

## For Customers in Canada

This Class B digital apparatus complies with Canadian ICES-003.

## Safety

- Operate the TV only on 120 V AC.
- Use the AC power cord specified by Sony and suitable for the voltage where you use it.
- The plug is designed, for safety purposes, to fit into the wall outlet only one way. If you are unable to insert the plug fully into the outlet, contact your dealer.
- If any liquid or solid object should fall inside the cabinet, unplug the TV immediately and have it checked by qualified service personnel before operating it further.
- If you will not be using the TV for several days, disconnect the power by pulling the plug itself. Never pull on the cord.
- For details concerning safety precautions, see "Important Safety Instructions" on page 5.

(Continued)

## Installing

- ❑ The TV should be installed near an easily accessible power outlet.
- ❑ To prevent internal heat buildup, do not block the ventilation openings.
- ❑ Do not install the TV in a hot or humid place, or in a place subject to excessive dust or mechanical vibration.
- ❑ Use the TV at temperatures between 41°F (5°C) and 95°F (35°C).
- ❑ If the TV is transported directly from a cold to a warm location, or if the room temperature changes suddenly, the picture may be blurred or show poor color due to moisture condensation. In this case, please wait a few hours to let the moisture evaporate before turning on the TV.
- ❑ To obtain the best picture, do not expose the screen to direct illumination or direct sunlight. It is recommended to use spot lighting directed down from the ceiling or to cover the windows that face the screen with opaque drapery. It is desirable to install the TV in a room where the floor and walls are not of a reflective material.
- ❑ See pages 13 and 14 for more information on the installation.

## CAUTION

Use the following Sony appliance(s) only with the following TV STAND. Use with other TV STAND may cause instability and possibly result in injury.

SONY APPLIANCE MODEL NO.

KDS-R50XBR1

KDS-R60XBR1

SONY TV STAND MODEL NO.

SU-GW12

SONY THEATRE STAND SYSTEM MODEL NO.

RHT-G2000

## To Customers

Sufficient expertise is required for installing the specified product. Be sure to subcontract the installation to Sony dealers or licensed contractors and pay adequate attention to safety during the installation.

## For Customers in the United States

This product contains mercury. Disposal of this product may be regulated if sold in the United States. For disposal or recycling information, please contact your local authorities or the Electronics Industries Alliance (<http://www.eiae.org>).

## Note

This digital television is capable of receiving analog basic, digital basic and digital premium cable television programming by direct connection to a cable system providing such programming. A security card provided by your cable operator is required to view encrypted digital programming. Certain advanced and interactive digital cable services such as video-on-demand, a cable operator's enhanced program guide and data-enhanced television services may require the use of a set-top box. For more information call your local cable operator.

This television also includes a QAM demodulator which should allow you to receive unscrambled digital cable television programming via subscription service to a cable service provider. Availability of digital cable television programming in your area depends on the type of programming and signal provided by your cable service provider.

## Trademark Information

CableCARD™ is a trademark of Cable Television Laboratories, Inc.

TruSurround, SRS and the (●)® symbol are trademarks of SRS Labs, Inc. TruSurround technology is incorporated under license from SRS Labs, Inc.

Licensed by BBE Sound, Inc. under USP4638258, 4482866. "BBE" and BBE symbol are trademarks of BBE Sound, Inc.

Macintosh is a trademark licensed to Apple Computer, Inc., registered in the U.S.A and other countries.

WEGA, Steady Sound, Digital Reality Creation, CineMotion, BN Smoother, Memory Stick, Memory Stick Duo, Memory Stick PRO, Memory Stick PRO Duo, MagicGate, MID and Twin View are trademarks of Sony Corporation. i.LINK is a trademark of Sony Corporation and used only to designate that a product contains an IEEE 1394 connector. All products with an i.LINK connector may not communicate with each other.

PlayStation is a trademark of Sony Computer Entertainment, Inc.



This TV is manufactured under license from Dolby Laboratories. "Dolby" and the double-D symbol are trademarks of Dolby Laboratories.



This TV incorporates High-Definition Multimedia Interface (HDMI™) technology.

HDMI, the HDMI logo and High-Definition Multimedia Interface are trademarks or registered trademarks of HDMI Licensing LLC.

# Important Safety Instructions

- 1) Read these instructions.
- 2) Keep these instructions.
- 3) Heed all warnings.
- 4) Follow all instructions.
- 5) Do not use this apparatus near water.



- 6) Clean only with dry cloth.

- 7) Do not block any ventilation openings. Install in accordance with the manufacturer's instructions.



- 8) Do not install near any heat sources such as radiators, heat registers, stoves, or other apparatus (including amplifiers) that produce heat.



- 9) Do not defeat the safety purpose of the polarized or grounding-type plug. A polarized plug has two blades with one wider than the other. A grounding type plug has two blades and a third grounding prong. The wide blade or the third prong are provided for your safety. If the provided plug does not fit into your outlet, consult an electrician for replacement of the obsolete outlet.



- 10) Protect the power cord from being walked on or pinched particularly at plugs, convenience receptacles, and the point where they exit from the apparatus.



- 11) Only use attachments/accessories specified by the manufacturer.



- 12) Use only with the cart, stand, tripod, bracket, or table specified by the manufacturer, or sold with the apparatus. When a cart is used, use caution when moving the cart/apparatus combination to avoid injury from tip-over.



- 13) Unplug this apparatus during lightning storms or when unused for long periods of time.



- 14) Refer all servicing to qualified service personnel. Servicing is required when the apparatus has been damaged in any way, such as power-supply cord or plug is damaged, liquid has been spilled or objects have fallen into the apparatus, the apparatus has been exposed to rain or moisture, does not operate normally, or has been dropped.



- Be sure to observe the TV's "For Safety" section on page 6.

## Antennas

### Outdoor Antenna Grounding

If an outdoor antenna is installed, follow the precautions below. An outdoor antenna system should not be located in the vicinity of overhead power lines or other electric light or power circuits, or where it can come in contact with such power lines or circuits.

**WHEN INSTALLING AN OUTDOOR ANTENNA SYSTEM, EXTREME CARE SHOULD BE TAKEN TO KEEP FROM CONTACTING SUCH POWER LINES OR CIRCUITS AS CONTACT WITH THEM IS ALMOST INVARIABLY FATAL.**

Be sure the antenna system is grounded so as to provide some protection against voltage surges and built-up static charges.

Section 810 of the National Electrical Code (NEC) in USA and Section 54 of the Canadian Electrical Code in Canada provides information with respect to proper grounding of the mast and supporting structure, grounding of the lead-in wire to an antenna discharge unit, size of grounding conductors, location of antenna discharge unit, connection to grounding electrodes, and requirements for the grounding electrode.

### Antenna Grounding According to the NEC

Refer to section 54-300 of Canadian Electrical Code for Antenna Grounding.

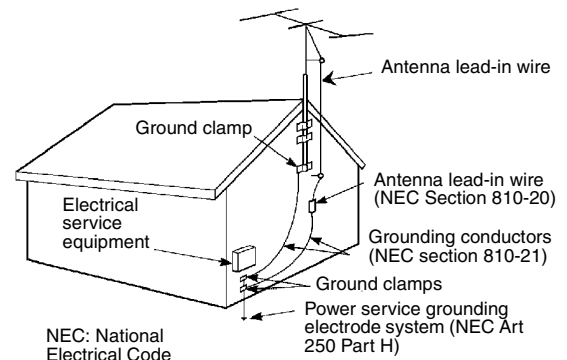

(Continued)

## Cleaning

- Clean the rear cover area of the TV regularly. Dust in the rear cover area may cause a problem with the cooling system of the TV set.
- Clean the cabinet of the TV with a dry soft cloth. To remove dust from the screen, wipe it gently with a soft cloth. Stubborn stains may be removed with a cloth slightly dampened with solution of mild soap and warm water. Never use strong solvents such as thinner or benzine for cleaning. If the picture becomes dark after using the TV for a long period of time, it may be necessary to clean the inside of the TV. Consult qualified service personnel.
- Unplug the AC power cord when cleaning this unit. Cleaning this unit with a plugged AC power cord may result in electric shock.



## On Contamination on the Screen Surface

The screen surface has a special coating to reduce reflections. To prevent screen damage, clean the screen as follows:

- Clean the screen with a soft cloth.
- To remove hard contamination, use a cloth moistened with a solution of mild detergent and water. Do not spray cleaning solution directly onto the TV. It should only be sprayed to moisten the cleaning cloth.
- Do not use any type of abrasive pad, alkaline cleaner, acid cleaner, scouring powder, chemical cloth, or solvent such as alcohol, benzene or thinner, as these may scratch the screen's coating.

## Service

### Damage Requiring Service

Do not attempt to service the set by yourself since opening the cabinet may expose you to dangerous voltage or other hazards.

Unplug the set from the wall outlet and refer servicing to qualified service personnel.



### Replacement Parts

When replacement parts are required, be sure the service technician certifies in writing that he has used replacement parts specified by the manufacturer that have the same characteristics as the original parts.

Unauthorized substitutions may result in fire, electric shock or other hazards.

See "Replacing the Lamp" on page 104.

## For Safety

### Be Careful When Moving the TV

When you place the TV in position, be careful not to drop it on your foot or fingers.

Watch your footing while installing the TV.



### Carry the TV in the Specified Manner

If you carry the TV in a manner other than the specified manner and without the specified number of persons, it may drop and a serious injury may be caused. Be sure to follow the instructions mentioned below.

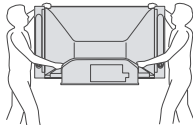

- Carry the TV with the specified number of persons (see page 13).
- Hold the TV tightly when carrying it.
- Before carrying the TV, disconnect any accessories or cables.

## About the TV

Although the TV is made with high-precision technology, black dots may appear or bright points of light (red, blue, or green) may appear constantly on the screen. This is a structural property of the panel and is not a defect.

## Installation

- If direct sunlight or other strong illumination shines on the screen, part of the screen may appear white due to reflections from behind the screen. This is a structural property of the TV. Do not expose the screen to direct illumination or direct sunlight.
- The picture quality may be affected by your viewing position. For the best picture quality, install your TV according to "Recommended Viewing Area" on page 15.
- Leave some space around your TV. Otherwise, adequate air-circulation may be blocked causing overheating and cause fire or damage the unit. For details, see "When Installing Your TV against a Wall" on page 14.

## Projection Lamp

- Your TV uses a projection lamp as its light source. It is time to replace the lamp with a new one (not supplied) when:
  - the lamp replacement indicator on the front panel blinks in red,
  - screen images become dark,
  - no image appears on the display after prolonged use.
- In rare instances, the bulb may pop inside the lamp unit, but the lamp unit is designed to contain all of broken glass pieces inside the lamp unit. (See "Replacing the Lamp" on page 104.)
- When the lamp eventually burns out, you may hear a noticeable pop sound. This is normal and is inherent in this type of lamp.

## Disposal of Used Batteries

To preserve our environment, dispose of used batteries according to your local laws or regulations.

## Objects and Liquid Entry

Do not place any objects on the unit.

The apparatus shall not be exposed to dripping or splashing and no objects filled with liquids, such as vases, shall be placed on the apparatus.

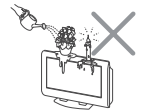

## Cooling Fan

This TV uses a cooling fan. You may hear the noise of fan running, depending on the placement of your TV. The noise may be more noticeable during the night or when the background noise level is low.

Also the noise of cooling fan may become louder when High Altitude is set to On.

# Contents

## Introducing the TV

<b>Welcome</b> .....	<b>9</b>
Package Contents.....	9
Features.....	9
<b>Enjoying Your TV</b> .....	<b>11</b>
Notes on the TV .....	11
Screen.....	11
Indicators .....	12
Projection Lamp.....	12
<b>Installing the TV</b> .....	<b>13</b>
Carrying Your TV .....	13
Take Precaution during Installation.....	13
Preventing the TV from Toppling Over .....	14
When Installing Your TV against a Wall.....	14
Recommended Viewing Area .....	15
<b>TV Controls and Connectors</b> .....	<b>16</b>
Front Panel .....	16
Front Connectors .....	17
Rear Panel.....	18

## Connecting the TV

<b>Overview</b> .....	<b>21</b>
Making Video and Audio Connections .....	21
About Using S VIDEO.....	22
About Using HDMI to DVI Adapter.....	22
<b>Basic Connections</b> .....	<b>23</b>
Cable System or VHF/UHF .....	24
Cable Box and Antenna .....	25
Cable Box .....	26
Satellite Receiver .....	27
Digital Cable Box or Digital Satellite Receiver .....	28
Equipment with HDMI Connection .....	29
Equipment with DVI Connection .....	30
Equipment with Digital Audio (Optical).....	31
<b>Using the CableCARD Device</b> .....	<b>32</b>
About Using the CableCARD Device.....	32
Activating CableCARD Service.....	32
Removing the CableCARD Device .....	33
<b>Setting Up the Channel List</b> .....	<b>34</b>

Using Initial Setup .....	34
<b>Connecting Optional Equipment</b> .....	<b>35</b>
VCR and Cable .....	36
VCR and Cable Box .....	37
DVD Player with Component Video Connectors.....	39
DVD Player with S VIDEO and Audio Connectors .....	40
Personal Computer .....	41
Camcorder or PlayStation .....	42
Audio Receiver.....	43

## Watching the TV

<b>Overview</b> .....	<b>45</b>
<b>Inserting Batteries into the Remote Control</b> .....	<b>45</b>
<b>Button Descriptions</b> .....	<b>46</b>
<b>Programming the Remote Control</b> .....	<b>48</b>
<b>Using Other Equipment with Your Remote   Control</b> .....	<b>50</b>
<b>Special Buttons on the Remote Control</b> .....	<b>51</b>
Using the GUIDE Button .....	51
Using the WIDE Button .....	53
Using the JUMP Button.....	54
Using the FREEZE Button.....	54
<b>Using Twin View</b> .....	<b>55</b>
Displaying Twin Pictures .....	55
Activating the Picture.....	55
Changing the Picture Size.....	57
<b>Using Favorite Channels</b> .....	<b>58</b>
Using the Channel Menu.....	58
Using the Favorite Channels Guide .....	59
<b>Using the PC Input</b> .....	<b>60</b>
Displaying the PC Screen .....	60

## Using the Memory Stick Viewer

<b>About Memory Stick</b> .....	<b>61</b>
Features .....	61
Memory Stick Compatibility .....	61
File Compatibility .....	62
<b>Inserting and Removing a Memory Stick/   Memory Stick Duo</b> .....	<b>63</b>

(Continued)



Inserting a Memory Stick/ Memory Stick Duo.....	63
Removing a Memory Stick/ Memory Stick Duo.....	63
<b>Viewing Photo or Movie Files .....</b>	<b>64</b>
Using the Photo Viewer .....	65
Using the Movie Viewer .....	66
Using the Menu Bar Options.....	67
Memory Stick Precautions .....	70
Memory Stick Functionality .....	71

## ***Using i.LINK***

<b>Connecting i.LINK Devices .....</b>	<b>73</b>
<b>Selecting an i.LINK Device.....</b>	<b>75</b>
<b>Using the i.LINK Control Panel.....</b>	<b>76</b>
<b>i.LINK Setup .....</b>	<b>78</b>

## ***Using the Settings***

<b>Overview .....</b>	<b>79</b>
<b>Accessing the Video Settings .....</b>	<b>81</b>
Selecting Video Options.....	81
Selecting PC Video Options.....	85
<b>Accessing the Audio Settings .....</b>	<b>86</b>
Selecting Audio Options.....	86
Selecting PC Audio Options.....	87
<b>Accessing the Screen Settings .....</b>	<b>88</b>
Selecting Screen Options .....	88
<b>Accessing the Channel Settings .....</b>	<b>90</b>
Selecting Channel Options .....	90
<b>Accessing the Parental Lock Settings.....</b>	<b>92</b>
Selecting Parental Lock Options .....	92
Viewing Blocked Programs .....	93
Selecting Custom Rating Options .....	94
<b>Accessing the Setup Settings .....</b>	<b>96</b>
Selecting Setup Options .....	96
Programming Caption Vision .....	98
Selecting PC Setup Options .....	99
<b>Accessing the Applications Settings.....</b>	<b>101</b>
Selecting Applications Options .....	101

## ***Other Information***

<b>Overview .....</b>	<b>103</b>
<b>Contacting Sony .....</b>	<b>103</b>
<b>Replacing the Lamp.....</b>	<b>104</b>
How to Replace the Lamp.....	105
<b>Troubleshooting .....</b>	<b>108</b>
Twin View.....	108

Remote Control .....	108
CableCARD Device.....	109
Memory Stick.....	109
Video .....	111
Audio .....	111
Channels .....	112
General.....	113
<b>Specifications .....</b>	<b>115</b>
<b><i>Index</i></b>	
<b>Index.....</b>	<b>117</b>

# Introducing the TV

## Welcome

Thank you for purchasing this Sony SXRD projection TV. This manual is for models KDS-R50XBR1 and KDS-R60XBR1.

---

## Package Contents

Along with your new TV, the packing box contains a remote control and two AA (R6) batteries. See page 116 for the complete list of packaging contents.

---

## Features

Some of the features that you will enjoy with your new TV include:

- SXRD:** SXRD is a Silicon X-tal Reflective Display technology that delivers high-level resolution, greater contrast ratio, faster response speed and film-like reproduction compared to other conventional devices.
- WEGA Engine:** Delivers superb picture quality from any video source by minimizing the signal deterioration caused by digital-to-analog conversion and stabilizing the signal processing. This engine features unique Sony technology, including:
  - The first step in the digital processing system, Composite Component Processor (CCP-X), which enhances input signal-to-noise ratio by chroma decoder digital processing.
  - **DRC<sup>®</sup> (Digital Reality Creation)-MF V2:** Unlike conventional line doublers, the DRC Multifunction feature replaces the signal's NTSC waveform with the near-HD equivalent by digital mapping processing. The DRC Palette option lets you customize the level of detail (Reality) and smoothness (Clarity) to create up to three custom palettes.
  - **IFP (Image Format Processor):** The Digital Texture Enhancer function of this chip provides the optimal contrast by utilizing a wide dynamic range. This chip also reduces signal noise, by using an improved motion vector algorithm, while maintaining image sharpness.
- Advanced Iris:** This advance iris shutter works automatically open and close according to the incoming signal level to create brighter whites and better contrast in dark scenes.
- Integrated HDTV:** You can watch digital television programs and enjoy the improved audio/video quality offered by these programs.
- CineMotion<sup>®</sup>:** Using the reverse 3-2 pull down technology, the CineMotion feature provides smoother picture movement when playing back movies or other video sources on film.

(Continued)

- ❑ **BN Smoother™:** Reduces the block noise caused by digital video encoding and decoding process.
- ❑ **S-master Full Digital Amplifier:** Delivers superb clear dialog and reproduces the original sound quality while minimizing any sound fragmentation or jitter noise.
- ❑ **Wide Screen Mode:** Allows you to watch 4:3 normal broadcasts in wide screen mode (16:9 aspect ratio).
- ❑ **Twin View®:** Twin View allows you to watch two programs side by side with the ability to zoom in on one picture and listen to the program in the selected window. You can watch pictures from two different sources (480i) simultaneously.
- ❑ **Memory Stick Viewer:** Allows you to view digital photos (JPEG) and movies (MPEG1) from Memory Stick media on your TV screen.
- ❑ **Favorite Channels:** Allows you to select from 16 of your favorite channels without leaving the current channel.
- ❑ **CableCARD™ slot:** Provides cable subscribers with access to digitally encrypted cable channels — without the need for a set-top box — that will enable you to receive not only standard definition but also high definition television. The CableCARD device, which is provided by your cable TV company, is inserted into the TV's rear panel CableCARD slot. After the service is activated with your cable TV company, the card replaces the need for a separate set-top box. (Check with your cable TV company about CableCARD service details, limitations, pricing, and availability. For more information about the CableCARD device in this manual, see page 32.)
- ❑ **PC input:** Allows you to connect your PC and display the PC screen on your TV.
- ❑ **HDMI (High-Definition Multimedia Interface):** Provides an uncompressed, all-digital audio/video interface between this TV and any HDMI-equipped audio/video component, such as a set-top box, DVD player, and A/V receiver. HDMI supports enhanced, or high-definition video, plus two-channel digital audio.
- ❑ **i.LINK:** Provides a secure digital interface to other digital home entertainment devices. i.LINK allows for the secure transfer of copyright-protected high-definition content between these devices and your TV.

---

## Enjoying Your TV

To enjoy your TV for years to come and maintain its original picture quality, you should perform periodic maintenance.

---

### Notes on the TV

#### To enjoy clear picture

- ❑ Prevent sunlight or other light sources from shining directly on to the screen.
- ❑ The screen surface is easily scratched. Do not rub, touch, or tap it with sharp or abrasive objects (see “On Contamination on the Screen Surface” on pages 6).

#### When not using the TV for a long period of time

- ❑ Unplug the AC power cord from the outlet if you anticipate not using the TV for more than a week.

#### When turning off the power

- ❑ The cooling fan will continue to operate for about two minutes. Allow several minutes before unplugging from the outlet or switching the breaker off.

#### On moisture condensation

- ❑ If your TV is moved directly from a cold to a warm location or is placed in a humid room, or if the room temperature changes suddenly, the picture may blur or show poor color. This is caused by moisture condensation on the lenses inside. Wait a few hours to let the moisture evaporate before turning on the TV. When the condensation has evaporated, the picture will return to normal.

---

### Screen

To minimize reflection, the screen surface has a special coating. Inappropriate cleaning methods could damage the screen surface. Special care is required.

#### Cleaning the Screen Surface

Dust and dirt on the screen can affect the picture quality. To dust off the screen use a soft cloth. Be sure to follow the cleaning instruction on page 6 for stubborn stains and dirt.

## Indicators

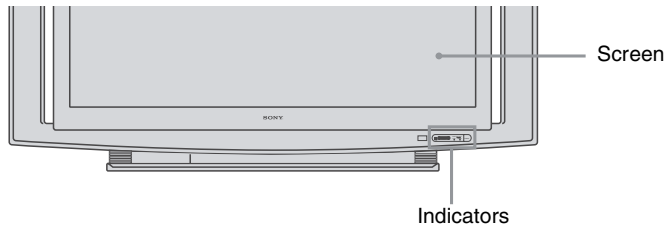

The indicators show the current status of your TV. If there is a change in the condition or a problem with the TV, the indicators will flash or light up in the manner described below to let you know that it requires your attention.

<b>Indicator</b>	<b>Flashing because...</b>	
POWER/ STANDBY flashing	Green	The lamp for the light source is preparing to turn on. When it is ready, it turns on.
	Red	The lamp door or the lamp is not securely attached. The red indicator will continue to flash in intervals of three blinks at a time until the lamp door or the lamp is placed correctly. The red indicator is on when i.LINK STANDBY is on or when your TV is in the PC power saving mode.
LAMP indicator flashes		The projection lamp has burned out. Replace it with new one (see page 104).
TIMER indicator is lit		When one of the timers is set the indicator will remain lit (will not flash) even when the TV is turned off.

## Projection Lamp

How to replace the lamp, see page 104.

Your TV uses a projection lamp as its light source. As with any lamp, it has limited life and needs to be replaced when the Lamp indicator flashes or the screen becomes darker. Note the following:

- After turning on your TV, it may take a while (1 minute or less) before the picture appears.
- When the projection lamp wears out, the screen goes dark. Replace the lamp with a new Sony XL-5100 replacement lamp (not supplied).

 **The light emitted from the lamp is quite bright when your TV is in use. To avoid eye discomfort or injury, do not look into the light housing when the power is on.**

## Installing the TV

### Carrying Your TV

Carrying the TV requires at least two people. Do not hold the TV by the pedestal or the front panel. Doing so may cause these parts to break off.

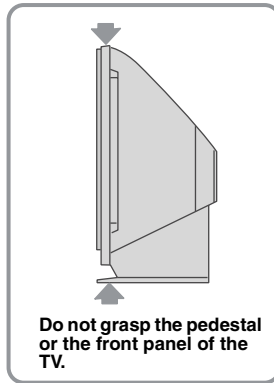

When moving the TV, place one hand in the hole on the lower portion of the TV while grasping the top with the other hand, as shown in the illustration below.

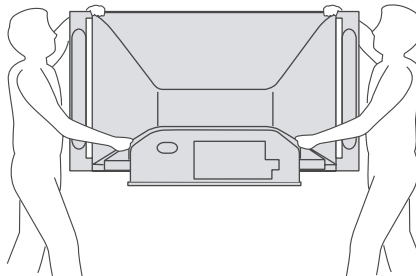

 **Do not carry the TV by grasping only the front panels.**

If you have connected cables and cords, be sure to unplug them before moving the TV.

### Take Precaution during Installation

To ensure the safety of children and the TV, keep children away from the TV during installation. Climbing on or pushing the TV or its stand may cause it to fall and damage the TV.

## Preventing the TV from Toppling Over

As a protective measure, secure the TV as follows.

### Using the TV stand with support belts

- ❑ Sony strongly recommends using the SU-GW12 TV stand with a support belt designed for your TV.

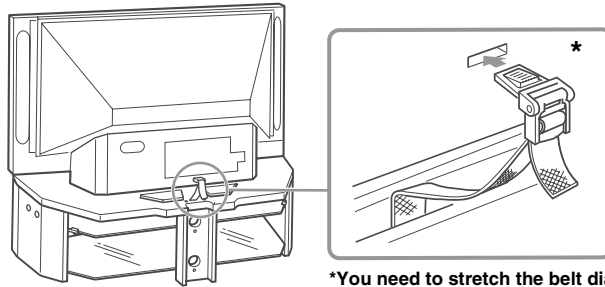

\*You need to stretch the belt diagonally to attach it to the TV.

 **When using the SU-GW12 stand for your TV, you must use the support belt.**

## When Installing Your TV against a Wall

Keep your TV at least 4 inches (10 cm) away from the wall to provide proper ventilation.

Blocking the ventilation opening of the cooling fan may cause a damage on the TV.

Allow this much space;

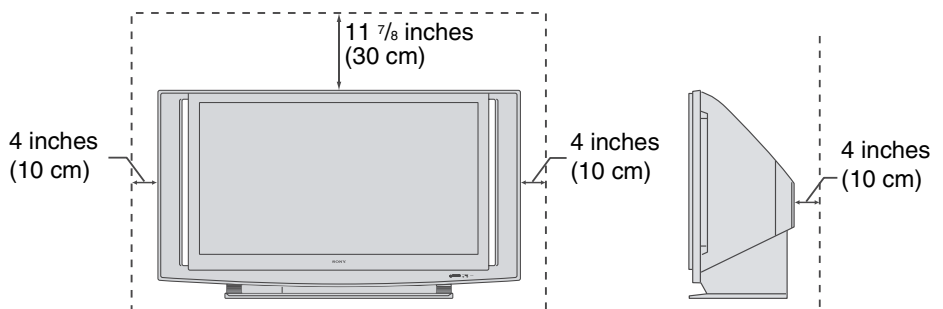

**Recommended  
Viewing Area**

Your viewing position may affect the picture quality.  
For the best picture quality, install your TV within the areas shown below.

<b>Model</b>	<b>Viewing distance</b>
KDS-R50XBR1	min. 6.6 ft. (approx. 2.0 m)
KDS-R60XBR1	min. 7.0 ft. (approx. 2.2 m)

**Horizontal Viewing Area**

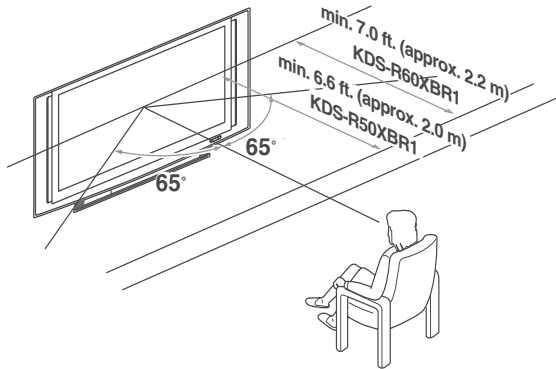

**Vertical Viewing Area**

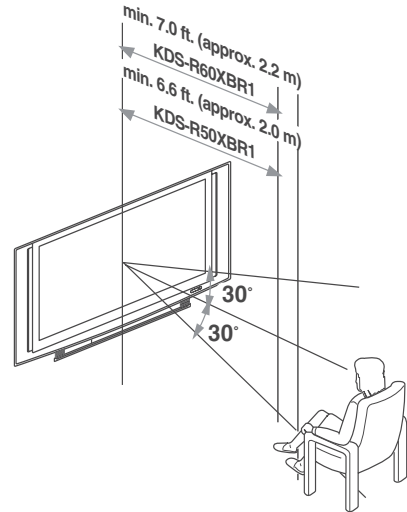



## TV Controls and Connectors

### Front Panel

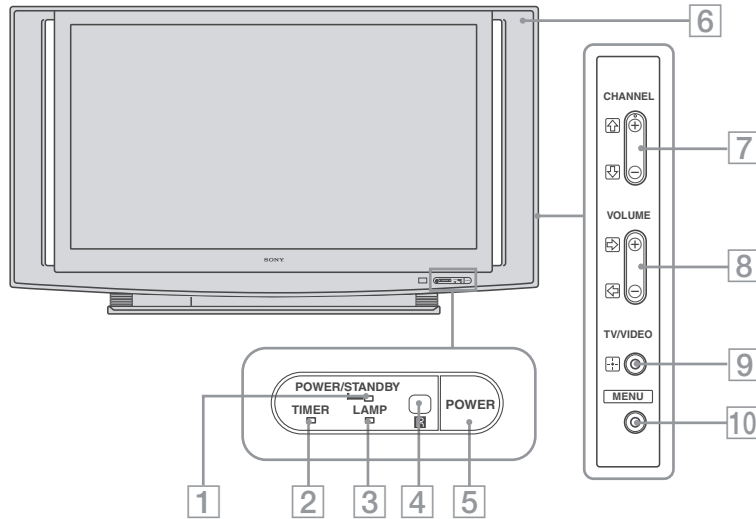

Item	Description
1 POWER/STANDBY LED	Lights up in green when the TV is turned on. If the LED blinks in red continuously, this may indicate the display unit needs servicing (see “Contacting Sony” on page 2). When the red LED blinks only three times, the lamp door of the lamp unit or the lamp itself is not securely attached (see page 106). The red indicator is on when i.LINK STANDBY is on or when your TV is in the PC power saving mode.
2 TIMER LED	When lit, indicates one of the timers is set. When it is set, this LED will remain lit even if the TV is turned off. For details, see page 101.
3 LAMP LED	Lights up in red when the lamp for the light source has burned out. For details, see “Replacing the Lamp” on page 104.
4 (IR) Infrared Receiver	Receives IR signals from the remote control. Do not put anything near the sensor, as its function may be affected.
5 POWER	Press to turn on and off the TV.
6 Speaker	Outputs audio signal.
7 CHANNEL +/-	Press to scan through channels. To scan quickly through channels, press and hold either - or +.
8 VOLUME +/-	Press to adjust the volume.
9 - -- TV/VIDEO	Press to confirm the selection or setting. Press repeatedly to cycle through the video equipment connected to the TV’s video inputs.
10 MENU	Press to display the TV on-screen setting and activate the - --, ←, →, ↓, and ↑ buttons. Press again to exit the TV on-screen setting and activate the TV/VIDEO, VOLUME +/- and CHANNEL +/- buttons.

**The CHANNEL + button has a tactile dot. Use the tactile dot as a reference when operating the TV.**

## Front Connectors

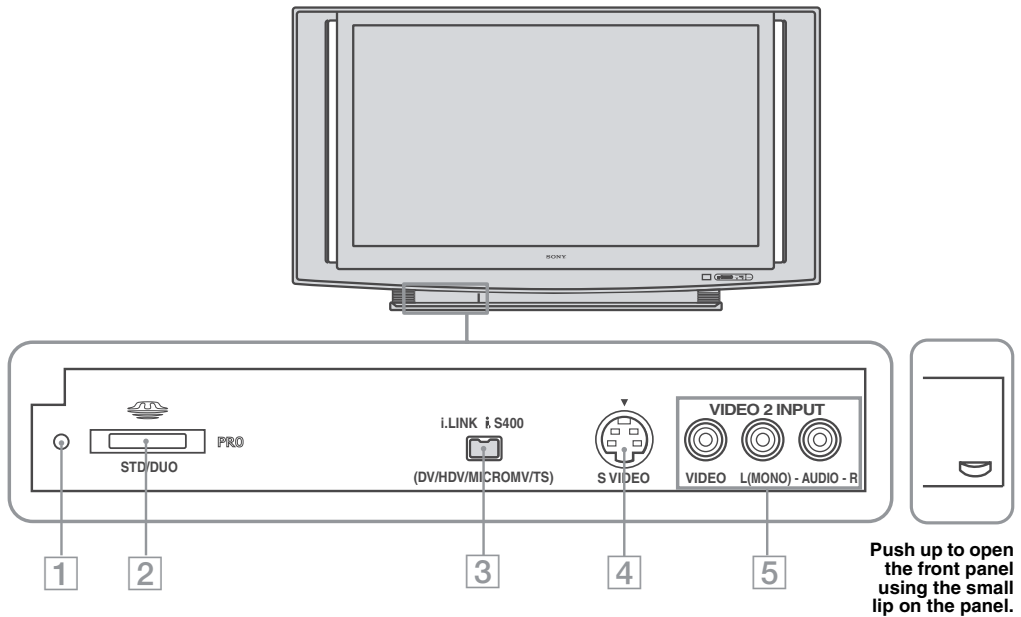

Front panel connectors are under the front panel cover

Item	Description
1	Memory Stick indicator When lit, indicates that the Memory Stick is being read. (Do not remove the Memory Stick when the indicator is lit.)
2	Memory Stick slot For inserting Memory Stick media to view on your TV. For details, See “Inserting and Removing a Memory Stick/Memory Stick Duo” on page 63.
3	i.LINK Connects to the i.LINK jack on your i.LINK-compatible portable device. Provides a secure digital connection between your TV and i.LINK-compatible portable device, such as a digital video camcorder.
4	S VIDEO Connects to the S VIDEO OUT jack of your VCR, camcorder, or other S VIDEO-equipped video component. Provides better picture quality than the VHF/UHF jacks or the VIDEO IN jack.
5	VIDEO/ L(MONO)-AUDIO-R Connects to the audio and video OUT jacks on your VCR or other video component.

Rear Panel

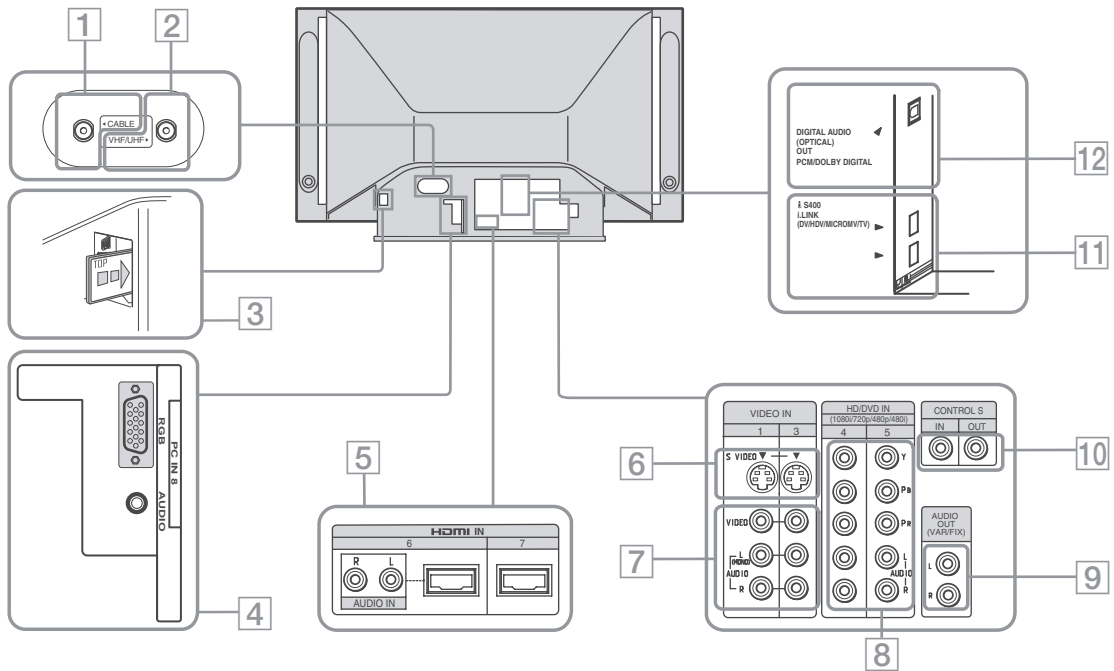

Jack	Description
1 CABLE	Connects to your cable signal. This CABLE input jack, in conjunction with the VHF/UHF input jack, lets you set up your TV to switch between scrambled channels (coming through a cable box) and unscrambled cable channels. For details, see page 25.
2 VHF/UHF	Connects to your VHF/UHF antenna or cable box output jack.
3 CableCARD slot	CableCARD provides cable subscribers with access to secure, digitally encrypted cable channels — without the need for a set-top box — that will enable you to receive not only standard definition but also high definition television. For details, see page 32.
4 VIDEO 8 (PC) IN	Connect to the video output connector and audio output jack on your personal computer. For details, see page 41.
5 HDMI (VIDEO 6 IN and VIDEO 7 IN)	HDMI (High-Definition Multimedia Interface) provides an uncompressed, all-digital audio/video interface between this TV and any HDMI-equipped audio/video component, such as a set-top box, DVD player, and A/V receiver. HDMI supports enhanced, or high-definition video, plus two-channel digital audio. You can also connect a DVI-equipped device to your TV by using an HDMI-to-DVI cable.
6 S VIDEO	Connects to the S VIDEO OUT jack of your VCR, camcorder, or other S VIDEO-equipped video component. Provides better picture quality than the VHF/UHF jacks or the VIDEO IN jack.
7 VIDEO/ L(MONO)-AUDIO-R	Connects to the audio and video OUT jacks on your VCR or other video component. A third video input (VIDEO 2) is located on the front panel of the TV.

Jack	Description
8 HD/DVD IN (1080i/720p/480p/480i)	Connects to your DVD player or digital set-top box's component video (YPbPr) and audio (L/R) jacks.
9 AUDIO OUT (VAR/FIX) L/R	Connects to the left and right audio inputs of your audio or video component.  <b>AUDIO OUT jacks are operable only when the TV's Speaker is set to Off. For details, see page 87.</b>
10 CONTROL S IN/OUT	To control other Sony equipment with the TV's remote control, connect the CONTROL S IN jack of the equipment to the CONTROL S OUT jack on the TV with the CONTROL S cable. To control the TV with the remote control of another Sony product, connect the CONTROL S OUT jack of the equipment to the CONTROL S IN jack on the TV with the CONTROL S cable.
11 i.LINK	Connects to the i.LINK jack on your i.LINK device. Provides a secure digital connection between your TV and i.LINK device, such as digital VCRs and digital set-top boxes.
12 DIGITAL AUDIO (OPTICAL) OUT (PCM/DOLBY* DIGITAL)	Connects to the optical audio input of a digital audio component that is PCM/Dolby digital compatible.

\* Manufactured under license from Dolby Laboratories. "Dolby" and the double-D symbol are trademarks of Dolby Laboratories.



# Connecting the TV

## Overview

Your new SXRD projection TV can receive both analog and digital broadcasting signals from antenna, satellite and cable TV.





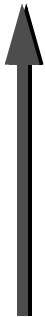

To display clear crisp pictures, you must connect your TV correctly and choose the correct display format (see “Using the WIDE Button” on page 53). It is strongly recommended to connect the antenna using a 75-ohm coaxial cable to receive optimum picture quality signal. A 300-ohm twin lead cable can be easily affected by radio noise and the like, resulting in signal deterioration. If you use a 300-ohm twin lead cable, keep it as far away as possible from the TV.

## Making Video and Audio Connections

To get the most out of your TV, the input signals to the TV (and connected devices) should use the connections that provide the best video and audio performance. The chart below shows typical connectors that are currently available on the latest A/V devices.

**Best Video Performance**



	Connector type	Separate audio connection required
	HDMI (High-Definition Multimedia Interface)	No
	DVI (Digital Visual Interface) *	Yes 
	Component video (480i/480p/720p/1080i)	
	S VIDEO	
	Composite video	
	RF/Coaxial	No

\* An adapter is necessary when you are connecting a DVI-equipped device to this TV (see page 22).

## About Using S VIDEO



If the optional equipment you are connecting has an S VIDEO jack (shown at left), you can use an S VIDEO cable for improved picture quality (compared to an A/V cable). Because S VIDEO carries only the video signal, you also need to connect audio cables for sound, as shown below.

### Example of an S VIDEO Connection

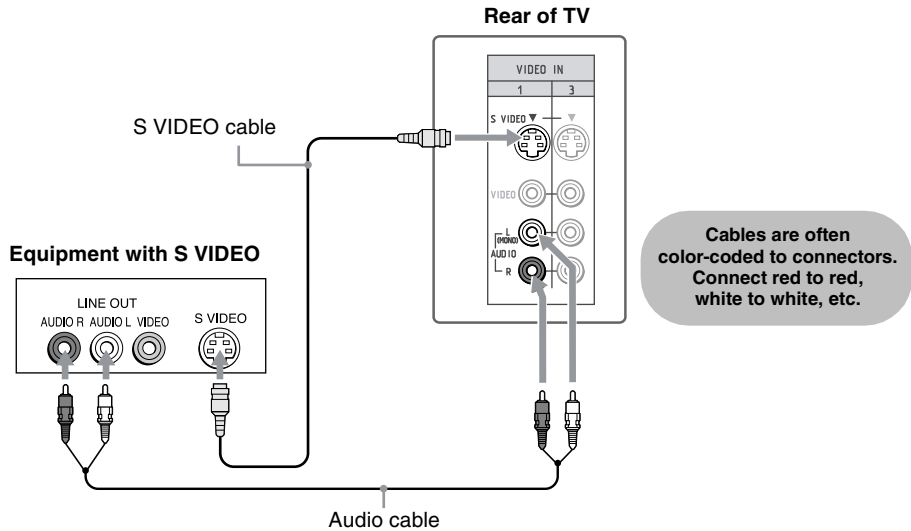

## About Using HDMI to DVI Adapter

If you are connecting equipment with a DVI connector to this TV, you will need to use an adapter. You can use an HDMI-to-DVI cable or an HDMI adapter (not supplied). Both are available at your local electronics store. When you use the adapter, you will also need to use separate audio cables for sound because the DVI connector carries video signals only.



HDMI-to-DVI cable



HDMI adapter

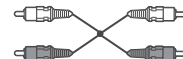

Audio cable

## Basic Connections

The way in which you connect your TV will vary, depending on how your home receives a signal (antenna and satellite; cable and cable box) and whether or not you plan to connect a VCR.

<b><i>If You Are Connecting</i></b>	<b><i>See Page</i></b>
<b><i>Cable System or VHF/UHF</i></b>	<b>24</b>
<input type="checkbox"/> No cable box or VCR	
<b><i>Cable Box and Antenna</i></b>	<b>25</b>
<input type="checkbox"/> Cable box unscrambles only some channels (usually premium channels)	
<input type="checkbox"/> No VCR	
<b><i>Cable Box</i></b>	<b>26</b>
<input type="checkbox"/> Cable box unscrambles all channels	
<input type="checkbox"/> No VCR	
<b><i>Satellite Receiver</i></b>	<b>27</b>
<b><i>Digital Cable Box or Digital Satellite Receiver</i></b>	<b>28</b>
<b><i>Equipment with HDMI Connection</i></b>	<b>29</b>
<b><i>Equipment with DVI Connection</i></b>	<b>30</b>
<b><i>Equipment with Digital Audio (Optical)</i></b>	<b>31</b>

### **If you are connecting a VCR**

- See the connections described on pages 36 and 37.



## Cable System or VHF/UHF

For best results, use this connection if you:

- ❑ Have a cable and/or an antenna.  
(This is convenient if you are using a separate rooftop antenna to receive additional channels that are not provided by your cable TV company.)
- ❑ Do not have a cable box or VCR. (If you have a cable box, see pages 25 and 26. If you have a VCR, see pages 36 and 37.)

### Antenna System

**Cable Type**      **Connect As Shown**

Cable TV (CATV)  
and Antenna

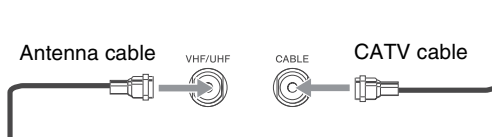

### Notes on Using This Connection

**To Do This...**

**Do This ...**

Switch the TV's input between  
the cable and antenna

Press ANT to switch back and forth between the  
TV's VHF/UHF and CABLE inputs.



**Do not use an indoor antenna, which is especially susceptible to radio noise.**

## Cable Box and Antenna

Before connecting a cable box, see “Using the CableCARD Device” on page 32.

### For best results, use this connection if:

- ❑ Your cable company scrambles some channels, such as premium channels (which requires you to use a cable box), but does not scramble all channels.
- ❑ You do not have a VCR. (If you have a VCR, see pages 36 and 37.)

### With this connection you can:

- ❑ Use the TV’s remote control to change channels coming through the cable box to the TV’s CABLE input. (You must first program the remote control for your specific cable box; see “Programming the Remote Control” on page 48.)
- ❑ Use the TV’s remote control to change channels coming directly into the TV’s VHF/UHF input jack.

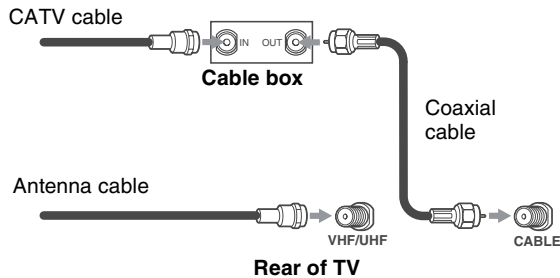

### Notes on Using This Connection

To Do This ...	Do This ...
Use the cable box	Tune the TV to the channel the cable box is set to (usually channel 3 or 4) and then use the cable box to switch channels.
Set up the TV remote control to operate the cable box	Program the remote control. See “Programming the Remote Control” on page 48.
Activate the remote control to operate the cable box	Press <b>SAT/CABLE (FUNCTION)</b> once, and the <b>SAT/CABLE</b> indicator lights up.
Prevent the accidental switching of TV channels	Use the <b>Channel Fix</b> setting to set the channels for the cable box. See “Accessing the Channel Settings” on page 90.
Switch the TV’s input between the cable box and antenna	Press <b>ANT</b> to switch back and forth between the TV’s VHF/UHF (antenna) and <b>CABLE</b> inputs.

## Cable Box

Before connecting a cable box, see “Using the CableCARD Device” on page 32.

### For best results, use this connection if:

- ❑ Your cable company scrambles all channels, which requires you to use a cable box.
- ❑ You do not have a VCR. (If you have a VCR, see pages 36 and 37.)

### With this connection you can:

- ❑ Use the TV’s remote control to change channels coming through the cable box to the TV’s VHF/UHF input jack. (You must first program the remote control for your specific cable box.)

### To connect the cable box

- 1** Connect the CATV cable to the cable box’s input jack.
- 2** Use a coaxial cable to connect the cable box’s output jack to the TV’s VHF/UHF input jack.
- 3** Run Auto Program, as described in “Setting Up the Channel List” on page 34.

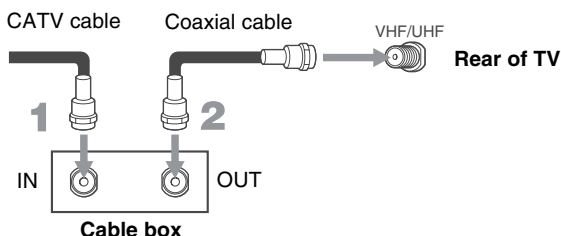

### Notes on Using This Connection

To do this...	Do This ...
Use the cable box	Tune the TV to the channel the cable box is set to (usually channel 3 or 4) and then use the cable box to switch channels.
Set up the TV remote control to operate the cable box	Program the remote control. See “Programming the Remote Control” on page 48.
Activate the remote control to operate the cable box	Press <b>SAT/CABLE (FUNCTION)</b> once, and the <b>SAT/CABLE</b> indicator lights up.
Prevent the accidental switching of TV channels	Use the <b>Channel Fix</b> setting to set the channels for the cable box. See “Accessing the Channel Settings” on page 90.

## Satellite Receiver

Disconnect all power sources before making any connections.

- 1** Connect the satellite antenna cable to the satellite receiver's SATELLITE IN jack.
- 2** Use A/V and S VIDEO cables to connect the satellite receiver's AUDIO and S VIDEO OUT jacks to the TV's AUDIO and S VIDEO IN jacks.
- 3** Use a coaxial cable to connect your cable to the TV's CABLE jack, or your antenna to the TV's VHF/UHF jack.

 **If your satellite receiver is not equipped with S VIDEO, use a VIDEO cable (yellow) instead of the S VIDEO cable.**

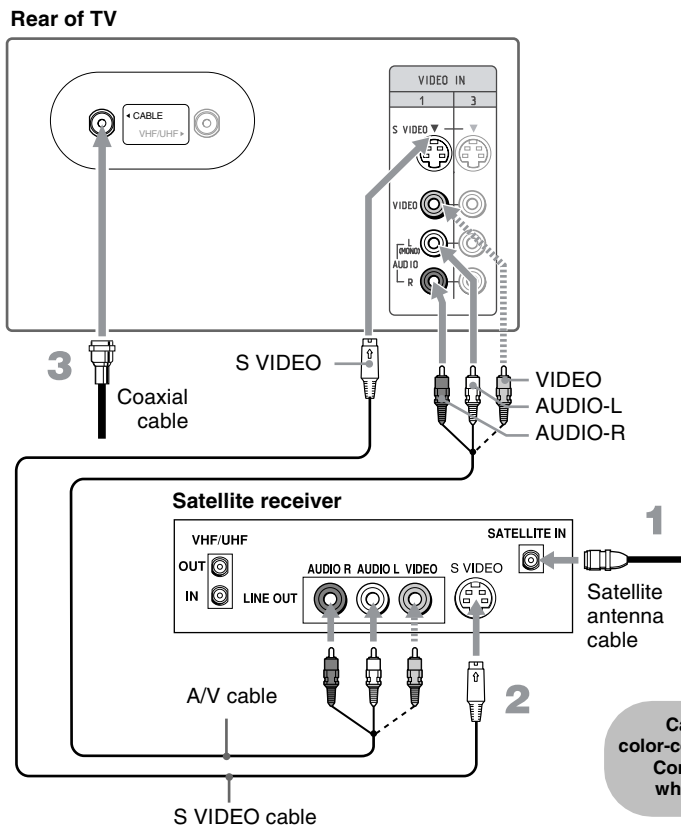

Cables are often color-coded to connectors. Connect red to red, white to white, etc.

Connecting the TV

## Digital Cable Box or Digital Satellite Receiver

Disconnect all power sources before making any connections.

- 1 Connect the RF coaxial cable from the CATV or satellite dish to the input of the digital cable box or digital satellite receiver.
- 2 Use a component video cable to connect the digital cable box or satellite receiver's YP<sub>B</sub>P<sub>R</sub> jacks to the TV's YP<sub>B</sub>P<sub>R</sub> jacks. Use the HD/DVD IN 4 or 5 input.

 **Component video (YP<sub>B</sub>P<sub>R</sub>) connection is necessary to view 480p, 720p, and 1080i formats. Note that this TV displays all format types of picture in a resolution of 1920 dots x 1080 lines.**

- 3 Use an audio cable to connect the digital cable box or satellite receiver's AUDIO OUT jacks to the TV's AUDIO IN jacks.

 **The YP<sub>B</sub>P<sub>R</sub> jacks do not provide audio, so audio cables must be connected to provide sound.**

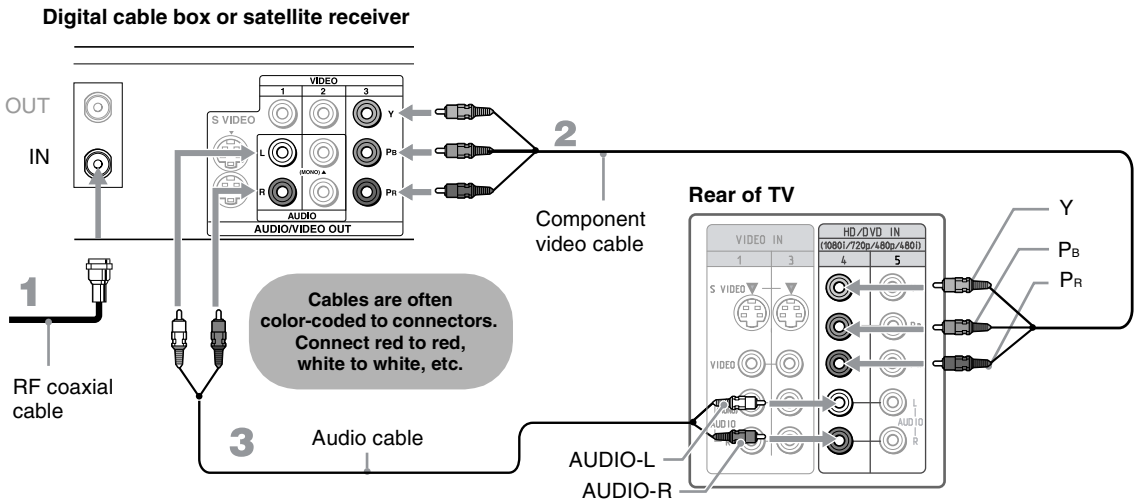

## Equipment with HDMI Connection

💡 The HDMI jack provides both video and audio signals, so it is not necessary to connect an audio cable.

Use this hookup if:

- ❑ Your equipment has a High-Definition Multimedia Interface (HDMI).

**Disconnect all power sources before making any connections.**

Using an HDMI cable, connect the equipment's HDMI OUT jack to the TV's HDMI IN jack.

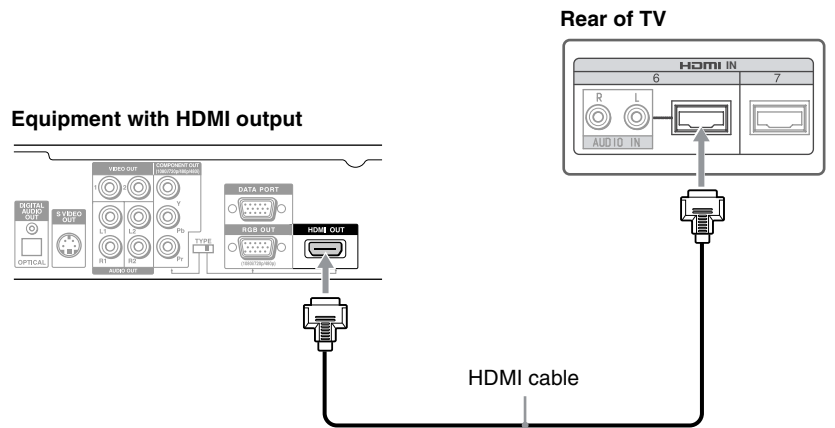



## Equipment with DVI Connection

**Disconnect all power sources before making any connections.**

If you are connecting with DVI-HDTV output, you can connect to the TV's HDMI IN jack by using an HDMI-to-DVI cable or an adapter (both not supplied).

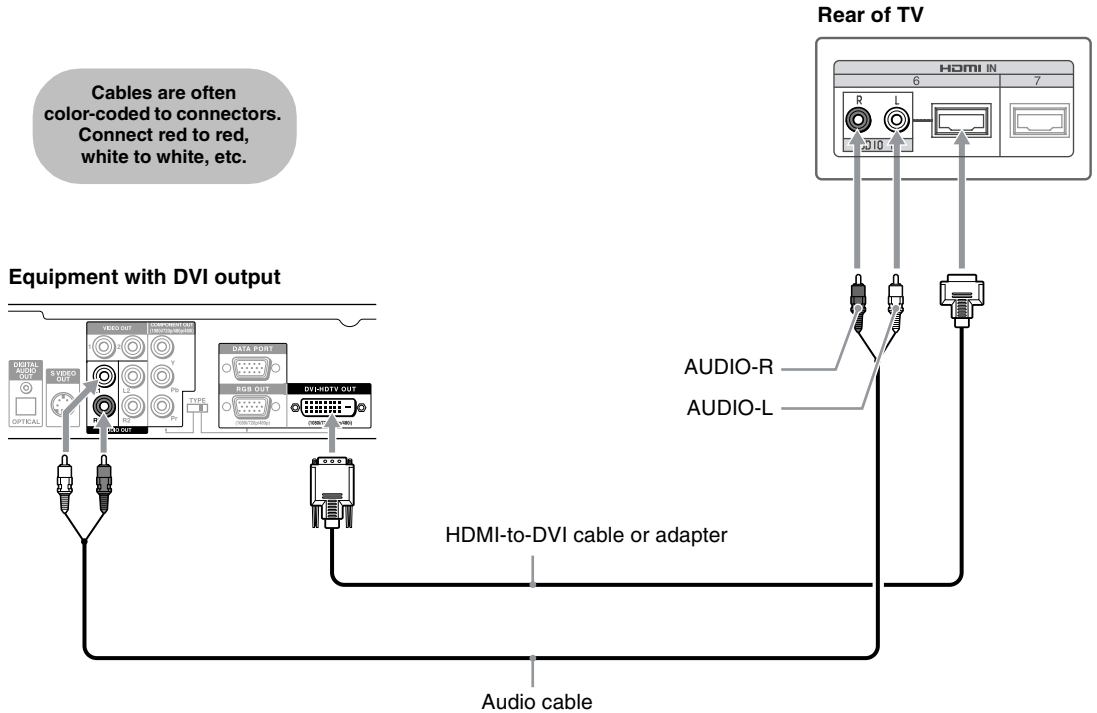
Cables are often color-coded to connectors. Connect red to red, white to white, etc.



 **When using a HDMI-to-DVI cable or an adapter, be sure to connect the DVI output connector first; then connect to the HDMI input on your TV.**

## Equipment with Digital Audio (Optical)

**Disconnect all power sources before making any connections.**

You can use the TV's DIGITAL AUDIO (OPTICAL) OUT jack to connect a digital audio device that is PCM/Dolby Digital compatible, such as an audio amplifier.

Using an optical audio cable, connect the device's OPTICAL IN jack to the TV's DIGITAL AUDIO (OPTICAL) OUT jack.

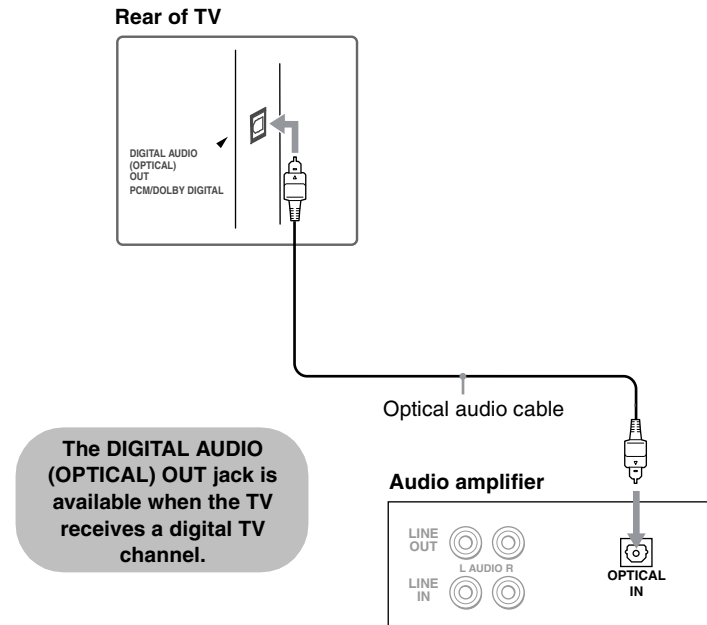

 You should also connect the TV's analog audio output jacks to the amplifier's analog audio input jacks so that the amplifier can output audio for analog channels. For details, see page 43.



## Using the CableCARD Device

The CableCARD device provides cable subscribers with access to digitally encrypted cable channels — without the need for a set-top box — that will enable you to receive not only standard definition but also high definition television. The CableCARD device, which is provided by your cable TV company, is inserted into the TV's rear panel CableCARD slot. After the service is activated with your cable TV company, the card replaces the need for a separate set-top box.

---

### About Using the CableCARD Device

If you are planning to use a separate cable box for digital cable TV services, you may be able to receive programming using this TV with the CableCARD device instead — except in the following circumstances:

- ❑ Your cable TV company does not provide CableCARD service in your viewing area.
- ❑ You want to access your cable TV company's interactive or advanced features (such as video-on-demand or, in some cases, pay-per-view). At this time, these services require a bidirectional link, which are only available through the use of a separate set-top box. CableCARD device is currently a unidirectional device only, and cannot provide these advanced services.

Check with your cable TV company for CableCARD service details, limitations, pricing, and availability, all of which are determined by your cable TV company — not Sony.

---

### Activating CableCARD Service

Before you can use CableCARD service, you need to insert the CableCARD device (supplied by your cable TV company) and activate the service, as described below:

- 1** Insert the CableCARD device into the CableCARD slot.

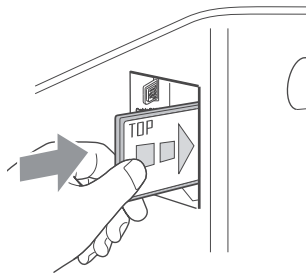

 **CAUTION:** When inserting the CableCARD device, the rear side of the card should be on your left side. Inserting the CableCARD incorrectly may result in permanent damage to the card and the TV.

- 2** Gently push the card into the slot until it locks into place.
- 3** After 1-2 minutes, the CableCARD device setup screen is automatically displayed. This screen includes information your cable TV company will request before they can activate your service.

 You can also access information about your CableCARD device in the Applications settings (see page 102).

- 4** Follow the displayed instructions: Phone your cable TV company. A representative will guide you through the activation process.
- 5** After your CableCARD device is activated, your cable TV company will download the service information, including the channel list, to the CableCARD device. After the CableCARD device has acquired channels from your cable TV company, the TV tunes to the lowest available channel.

## Removing the CableCARD Device

In the event you want to cancel your service, contact your cable TV company.

 **Once the CableCARD device is removed, your TV will no longer decrypt digital cable TV programming services that require CableCARD.**

- 1** Push the eject button on the CableCARD slot to release the card.

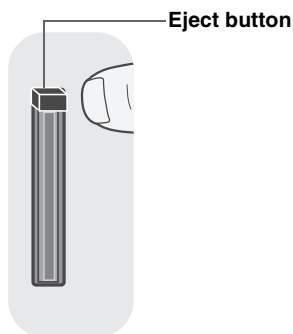

- 2** Pull the CableCARD device straight out of the slot to remove it. To install a different CableCARD device, follow the instructions in “Activating CableCARD Service” on page 32.





## Setting Up the Channel List

After you finish connecting the TV, you can run the Initial Setup to create a list of available analog and digital channels. The Initial Setup screen appears when you turn on the TV for the first time after hooking it up. If you choose to set up the channels at a later time, select the Auto Program option in the Channel setting to scan available channels (see below).

 **The Initial Setup feature does not apply for installations that use a cable box for all channel selection.**

### Using Initial Setup

#### To run Initial Setup the first time you turn on your TV

- 1** Press  to turn on the TV.  
The Initial Setup screen appears.
- 2** Press  or  to highlight the on-screen display language. Then press . The message “First please connect cable/antenna.” appears. This may require 50+ minutes for completion and “Start auto program now?” appears.



- 3** Press  or  to highlight “Yes” then press .

Auto Program performed through Initial Setup will automatically create a list of receivable channels from both VHF/UHF antenna and cable TV channels if both sources are connected.

 **Auto Program may take a while (20 to 50 minutes) to complete. A progress bar is displayed while available channels are being scanned. If you cancel the Auto Program before all receivable channels are scanned, you may want to perform the task later (see “To run Auto Program again at a later time” below).**

 **If you selected “No” during the Initial Setup, the Initial Setup message will appear each time you turn on the TV as a reminder until you complete the Auto Program.**

#### To run Auto Program again at a later time

- Use the Auto Program feature as described on page 90.

#### To add individual digital channels

- Use the Digital Channels feature as described on page 90.

## Connecting Optional Equipment

You can connect a variety of optional equipment to your TV. This section provides some of the individual connections you can make. For multiple connections, refer to the separate Quick Setup Guide.

<i>If You Are Connecting</i>	<i>See Page</i>
VCR and Cable	<b>36</b>
VCR and Cable Box	<b>37</b>
DVD Player with Component Video Connectors	<b>39</b>
DVD Player with S VIDEO and Audio Connectors	<b>40</b>
Personal Computer	<b>41</b>
Camcorder or PlayStation	<b>42</b>
Audio Receiver	<b>43</b>

## VCR and Cable

Use this hookup if:

- You have cable TV that does not require a cable box.

**Disconnect all power sources before making any connections.**

- 1** Connect the CATV cable to the single (input) jack of the splitter.
- 2** Use a coaxial cable to connect one of the output jack of the splitter to the TV's CABLE jack.
- 3** Use a coaxial cable to connect the splitter's other output jack to the VCR's input jack.
- 4** Use A/V and S VIDEO cables to connect the VCR's AUDIO and S VIDEO OUT jacks to the TV's AUDIO and S VIDEO IN jacks.

 **If your VCR is not equipped with S VIDEO, use a VIDEO cable (yellow) instead of the S VIDEO cable.**

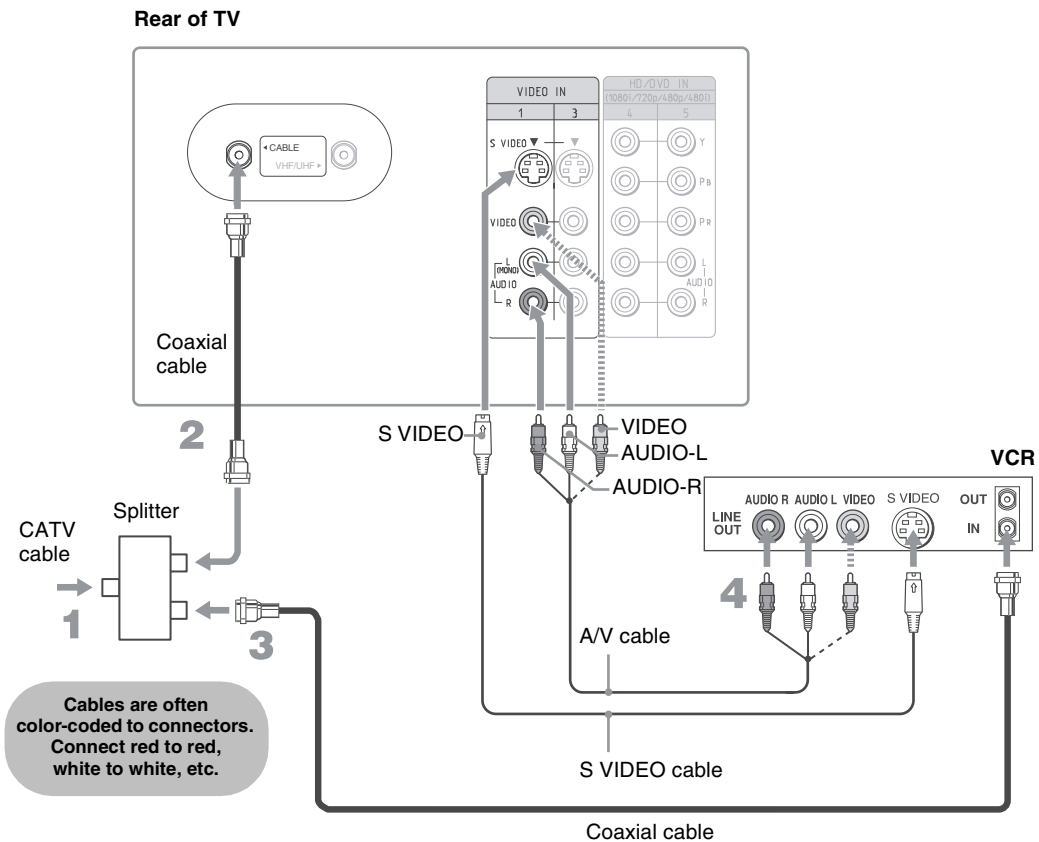

**VCR and Cable Box**

Before connecting a cable box, see "Using the CableCARD Device" on page 32.

Use this hookup if:

- ❑ Your cable TV company scrambles some channels, but not all of them (pay channels vs. regular cable channels) and you need to use a cable box.

With this connection you can:

- ❑ Use the TV's remote control to change channels on your cable box when the signal is scrambled. To program your Sony remote control to operate your cable box, see "Programming the Remote Control" on page 48.
- ❑ Use the TV's remote control to change channels on your TV when the signal is not scrambled. Your TV's tuner provides a better picture quality than the output of your cable box.

**Disconnect all power sources before making any connections.**

- 1** Connect the CATV cable to the single (input) jack of the splitter.
- 2** Use a coaxial cable to connect one of the output jack of the splitter to the TV's CABLE jack.
- 3** Use a coaxial cable to connect the splitter's other output jack to the cable box's input jack.
- 4** Use a coaxial cable to connect the cable box's output jack to the VCR's RF input jack.
- 5** Use an A/V cable to connect the cable box's A/V output jacks to the TV's A/V input jacks.
- 6** Use an A/V and S VIDEO cables to connect the VCR's AUDIO and S VIDEO OUT jacks to the TV's AUDIO and S VIDEO IN jacks.

 **If your VCR is not equipped with S VIDEO, use a VIDEO cable (yellow) instead of the S VIDEO cable.**

- 7** Run Initial Setup, as described in "Setting Up the Channel List" on page 34.

 **To view scrambled channels, tune the TV to the channel the cable box is set to (usually channel 3 or 4) and then use the cable box to switch channels.**

(Continued)

## Connecting the TV

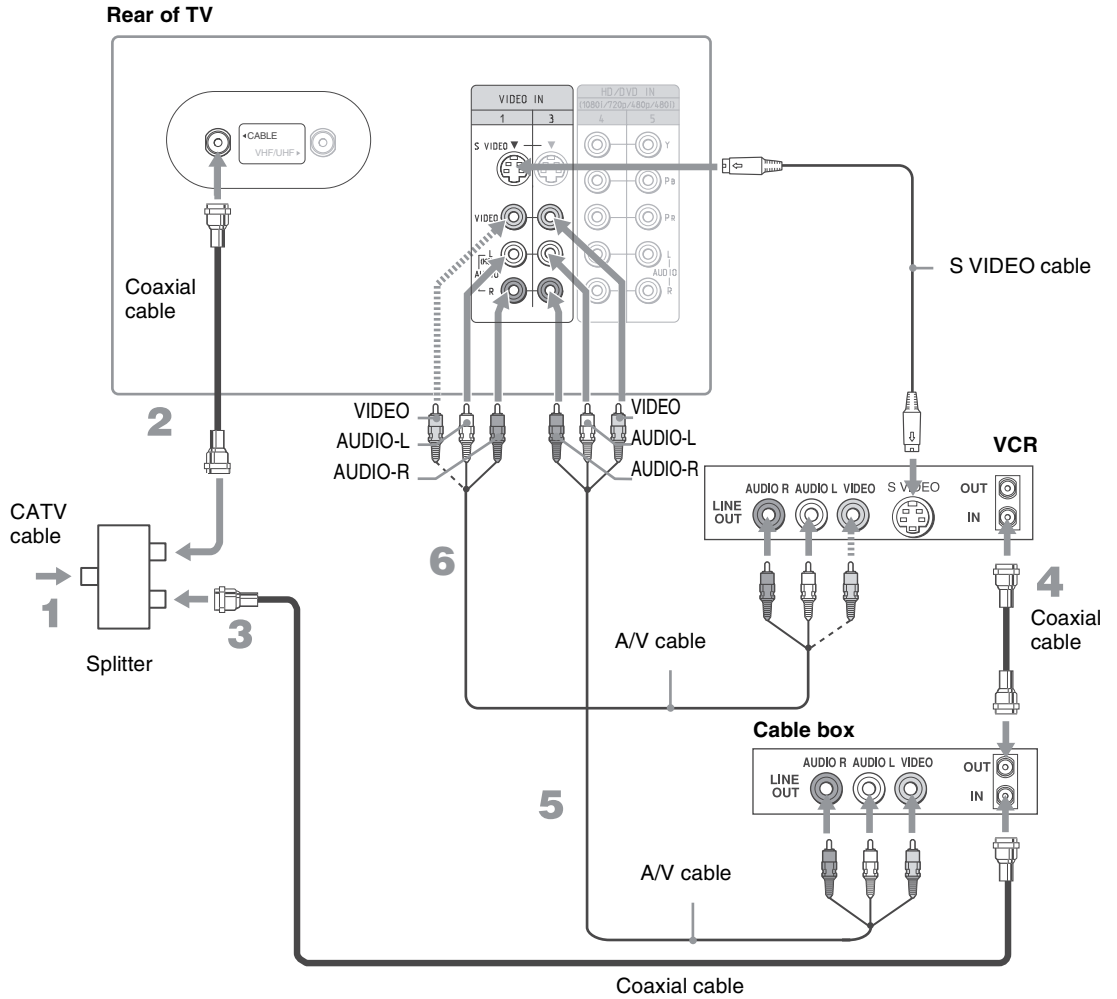

Cables are often color-coded to connectors. Connect red to red, white to white, etc.

If you are connecting a digital cable box, you will need a special bi-directional splitter designed to work with your cable box.

## DVD Player with Component Video Connectors

Use this hookup if:

- Your DVD player has component (YP<sub>B</sub>P<sub>R</sub>) jacks.

**Disconnect all power sources before making any connections.**

- 1** Use a component video cable to connect the DVD player's YP<sub>B</sub>P<sub>R</sub> jacks to the TV's YP<sub>B</sub>P<sub>R</sub> jacks. Use the HD/DVD IN 4 or 5 input.

 **The YP<sub>B</sub>P<sub>R</sub> jacks on your DVD player are sometimes labeled YC<sub>B</sub>C<sub>R</sub>, or Y, B-Y and R-Y. If so, connect the cables to like colors.**

- 2** Use an audio cable to connect the DVD player's AUDIO OUT jacks to the TV's AUDIO IN jacks. Be sure to use the same row of inputs that you used for the video connection (HD/DVD IN 4 or 5).

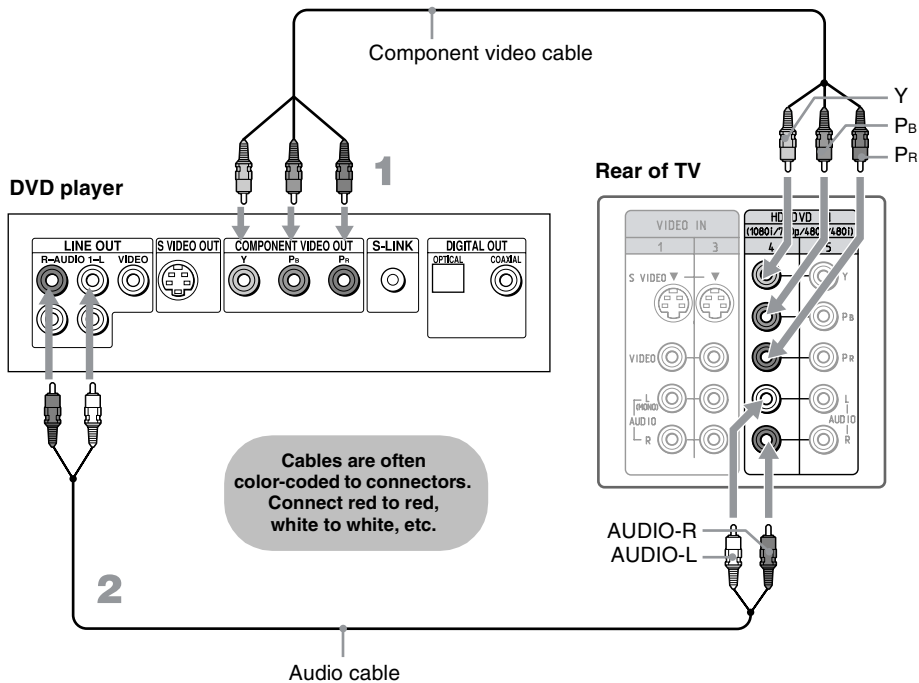

 **To take advantage of the Wide Mode feature, set the DVD player's aspect ratio to 16:9. For details, refer to the operating instructions supplied with your DVD player.**



## DVD Player with S VIDEO and Audio Connectors

Use this hookup if:

- Your DVD player does not have component (YPbPr) jacks.

**Disconnect all power sources before making any connections.**

- 1** Use an A/V cable to connect the DVD player's AUDIO OUT jacks to the TV's AUDIO IN jacks.
- 2** Use an S VIDEO cable to connect the DVD player's S VIDEO jack to the TV's S VIDEO jack.

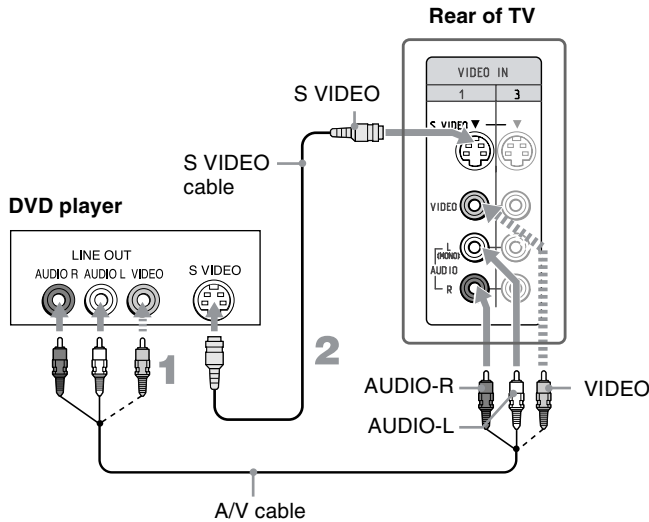

Cables are often color-coded to connectors. Connect red to red, white to white, etc.

- If your DVD player is not equipped with S VIDEO, use a VIDEO cable (yellow) instead of the S VIDEO cable.**
- To watch the DVD, press TV/VIDEO repeatedly to select the DVD input (VIDEO 1 in the illustration). If you have a non-Sony DVD player and want to set up the TV remote control to operate it, you must program the remote control. See “Programming the Remote Control” on page 48.**
- To control DVD functions with the TV remote control, See “Operating a DVD Player” on page 50.**
- To easily identify equipment connected to the TV, see “Label Video Inputs” on page 96.**

## Personal Computer

💡 When connecting to an Apple Macintosh computer, use the HD15-HD15 cable to connect PC IN of the TV to the video output connector of the computer. For some Apple Macintosh computers, it may be necessary to use an adapter (not supplied). If this is the case, connect the adapter to the computer before connecting the HD15-HD15 cable.

💡 If the picture is noisy or flickering, adjust the Phase and Pitch in the Screen settings on page 99.

### To connect a PC (personal computer)

If you connect your PC to the TV, you can watch your personal computer's display on the TV.

When your PC is connected to the TV with the HD15-HD15 cable and optional audio cable, you can view and listen to the PC's video and audio output on the TV.

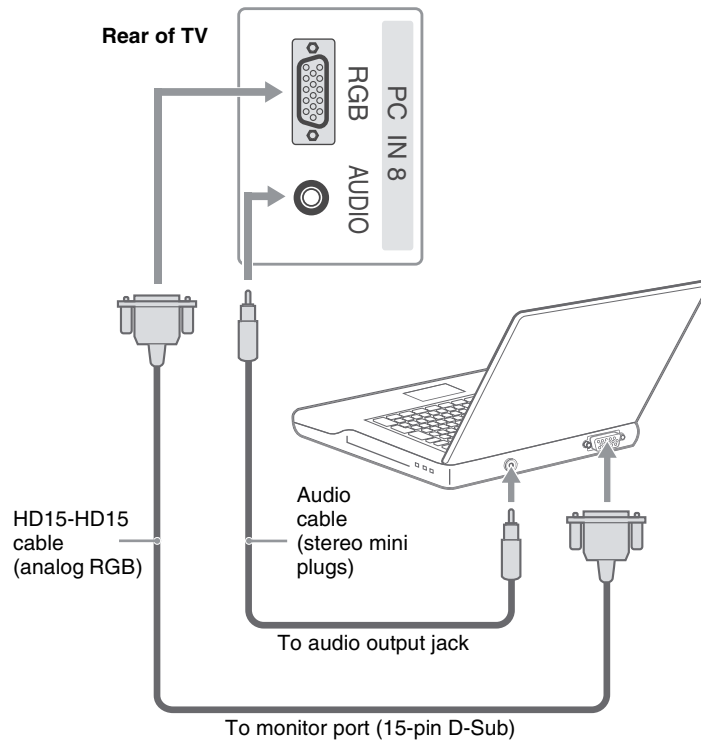

## Camcorder or PlayStation

**Disconnect all power sources before making any connections.**

For easy connection to a camcorder or PlayStation, the TV has front audio and video inputs (shown below).

Use A/V and S VIDEO cables to connect the camcorder or PlayStation AUDIO and S VIDEO OUT jacks to the TV's AUDIO and S VIDEO IN jacks.

 **If your camcorder is not equipped with S VIDEO, use a VIDEO cable (yellow) instead of the S VIDEO cable.**

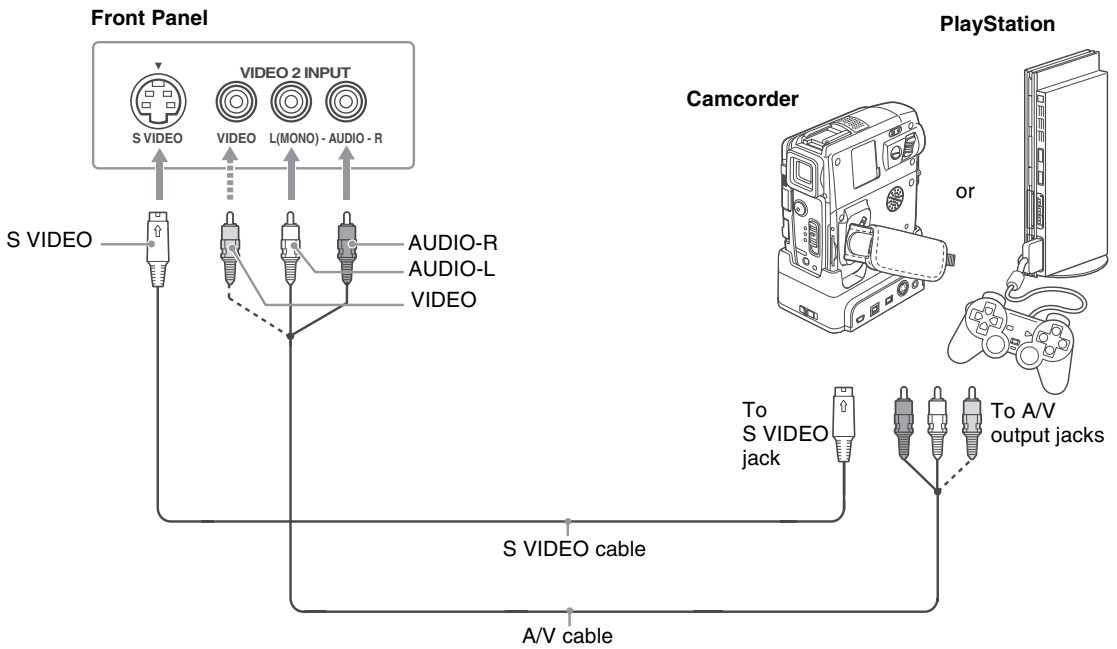

## Audio Receiver

For improved sound quality, you may want to play the TV's audio through your stereo system (see page 87).

**Disconnect all power sources before making any connections.**

Using an audio cable, connect the TV's AUDIO OUT (VAR/FIX) jacks to the audio receiver's audio LINE IN jacks.

 **AUDIO OUT jacks are operable only when the TV's Speaker is set to Off.**

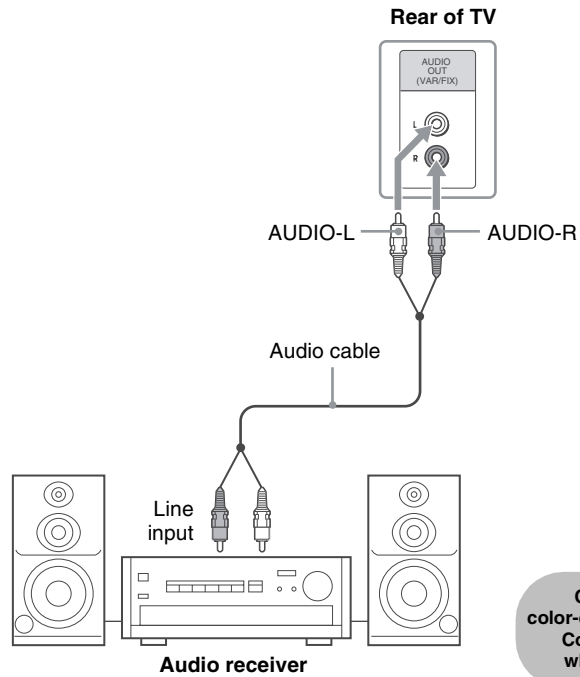



# Watching the TV

## Overview

This chapter includes the following topics:



Topic	Page
Inserting Batteries into the Remote Control	45
Button Descriptions	46
Programming the Remote Control	48
Manufacturer's Codes	49
Using Other Equipment with Your Remote Control	50
Special Buttons on the Remote Control	51

## Inserting Batteries into the Remote Control

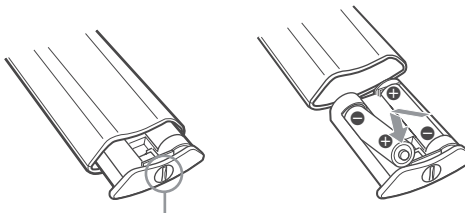
Insert two size AA (R6) batteries (supplied) by matching the **+** and **-** on the batteries to the diagram inside the battery compartment.



Use a coin to unscrew the lock

-  **To avoid possible damage from battery leakage, remove the batteries if you anticipate the remote control will not be used for an extended period.**
-  **Handle the remote control with care. Avoid dropping it, getting it wet, or placing it in direct sunlight, near a heater, or in high humidity.**
-  **Your remote control can be programmed to operate most video equipment. (See “Programming the Remote Control” on page 48)**

## Button Descriptions

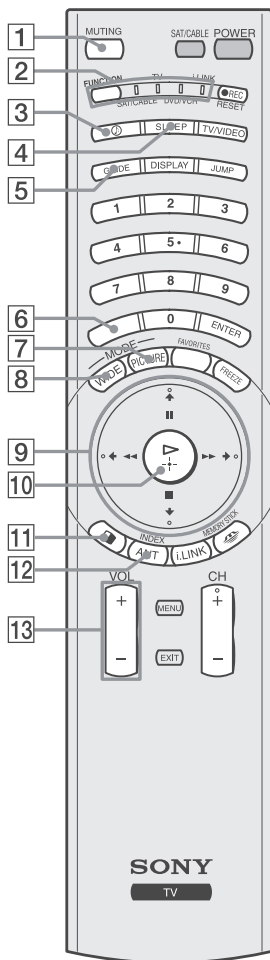

The 5 button and CH+ button have a tactile dot. Use the tactile as a reference when operating the remote control.

Button	Description
<b>1</b> MUTING	Press to mute the sound. Press again or press VOL + to unmute.
<b>2</b> FUNCTION	Press repeatedly until the indicator of the equipment (TV, SAT/CABLE, DVD/VCR, i.LINK) that you want to operate lights up.
<b>3</b>	Press repeatedly to cycle through the available audio effect modes: Dolby Virtual, TruSurround, Simulated, Off. For details, see “Selecting Audio Options” on page 86.
<b>4</b> SLEEP	Press repeatedly until the TV displays the time in minutes (15, 30, 45, 60 or 90) that you want the TV to remain on before shutting off. To cancel Sleep Timer, press SLEEP repeatedly until Off appears.
<b>5</b> GUIDE	Press to display the digital TV program guide. While FUNCTION is switched to SAT/CABLE, press to display the program guide of your satellite program provider.
<b>6</b>	Use with 0-9 and ENTER buttons to select digital channels (for example, 2.1). For details on selecting digital channels, see page 90.
<b>7</b> PICTURE	Press repeatedly to cycle through the available video picture modes: Vivid, Standard, Pro. The video picture modes can be also accessed in the Video setting. For details, see “Selecting Video Options” on page 81.
<b>8</b> WIDE	Press repeatedly to cycle through the wide screen mode setting: Wide Zoom, Normal, Full and Zoom. For details, see “Using the WIDE Button” on page 53.
<b>9</b>	When the setting is displayed, move the on-screen cursor. : Pause : Stop : Fast-Reverse : Fast-Forward
<b>10</b>	: Play : When the setting is displayed, select the item.
<b>11</b> (Twin View)	Press to turn on/off Twin View. For details, see “Using Twin View” on page 55.
<b>12</b> ANT	Press to change between the VHF/UHF input and the CABLE input.
INDEX	While FUNCTION is switched on SAT/CABLE, press to display index of your satellite program provider.
<b>13</b> VOL +/-	Press to adjust the volume.

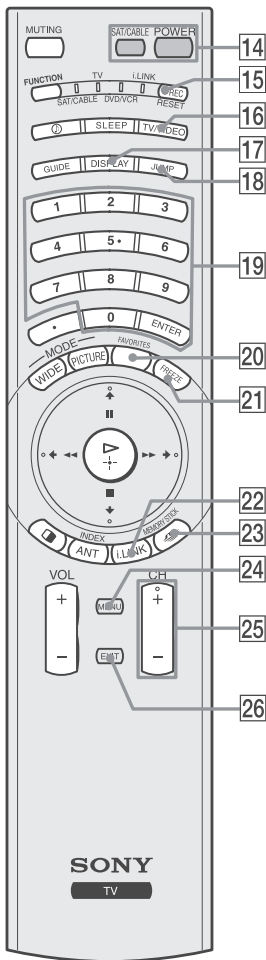

Button	Description
<b>14</b> POWER buttons	Press to turn on and on/off the TV and other audio/video equipment you have programmed into the remote control. For details, see “Programming the Remote Control” on page 48.
<b>15</b> REC	Record
<b>RESET</b>	Press when in a menu to reset the settings to the factory defaults. <b>RESET menu does not operate when in PC menu, Advanced Video, and White Balance.</b>
<b>16</b> TV/VIDEO	Press to cycle through the video equipment connected to your TV’s video inputs: TV, VIDEO 1, VIDEO 2, VIDEO 3, VIDEO 4, VIDEO 5, VIDEO 6, VIDEO 7 and VIDEO 8.
<b>17</b> DISPLAY	Press once to display the current time and channel label (if set) and channel number. Press again to turn Display off. See page 102 for details on setting the time.
<b>18</b> JUMP	Press to jump back and forth between two channels. The TV alternates between the current channel and the last channel that was selected.
<b>19</b> 0 - 9 and ENTER	Press 0 - 9 to select a channel: the channel changes after 3 seconds. Press ENTER to change channels immediately.
<b>20</b> FAVORITES	Press to display the Favorite Channels list. For details, see “Using Favorite Channels” on page 58.
<b>21</b> FREEZE	Press to freeze the current picture. Press again to restore the picture. For details, see “Using the FREEZE Button” on page 54.
<b>22</b> i.LINK	Press to display the i.LINK Control Panel. For details on using the i.LINK Control Panel, see page 76. Also available in the Applications setting (page 101).
<b>23</b> MEMORY STICK	Press to display the Memory Stick Menu. For details, see “Using the Memory Stick Viewer” on page 61.
<b>24</b> MENU	Press to display the TV on-screen setting. Press again to exit from the setting.
<b>25</b> CH +/-	Press to scan through channels. To scan quickly through the channels, press and hold down either +/- button.
<b>26</b> EXIT	Press to exit the on-screen setting or display and return to normal viewing.



## Programming the Remote Control

The remote control is preset to operate Sony brand video equipment.

Function	Equipment	Programmable Code Number
DVD/VCR	Sony Dream System	751
SAT/CABLE	Sony Satellite Receiver	801
i.LINK	Sony DVD player (i.LINK)	901

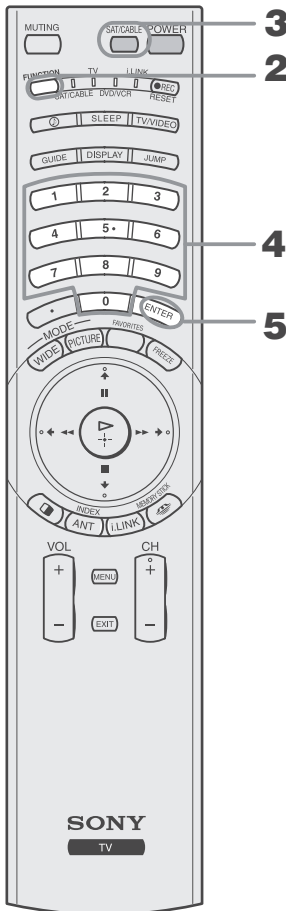

If you have video equipment other than Sony brand that you want to control with the TV's remote control, use the following procedure to program the remote control.

**The equipment must have infrared (IR) remote capability in order to be used with the remote control.**

- 1** Turn to the list of "Manufacturer's Codes" on page 49, and find the three-digit code number for the manufacturer of your equipment. (If more than one code number is listed, use the number listed first.)
- 2** Press repeatedly until the DVD/VCR, SAT/CABLE or i.LINK indicator lights up.
- 3** Press for five seconds until the indicator of the selected input flashes.
- 4** While the desired indicator is flashing, enter the three-digit manufacturer's code number.
- 5** Press .

**You must do step 5 within 10 seconds of step 4, or you must redo steps 4 through 5.**

### To check if the code number works

Aim the TV's remote control at the equipment and press that corresponds with that equipment. If it responds, you are done. If not, try using another code listed for that manufacturer.

**If no code is input within the above specified time, or an invalid or incorrect code number is input, the remote control automatically goes back to the previous setting.**

**In some cases, you may not be able to program your remote control to operate other equipment. In such cases, use the equipment's own remote control.**

**Removing the batteries or using dead batteries may cause the programmed codes to be lost and revert back to the factory setting. Reprogramming the codes may be necessary.**

**Manufacturer's Codes**

**DVD Players**

Manufacturer	Code
Sony	751
Sony (i.LINK)	901
General Electric	755
Hitachi	758
JVC	756
Magnavox	757
Mitsubishi	761
Oritron	759
Panasonic	753
Philips	757
Pioneer	752, 778
RCA/PROSCAN	755
Samsung	758
Toshiba	754
Zenith	760

**Laserdisc Players**

Manufacturer	Code
Sony	701
Panasonic	704, 710
Pioneer	702

**VCRs**

Manufacturer	Code
Sony	301, 302, 303
Admiral (M. Ward)	327
Aiwa*	338, 344
Audio Dynamic	314, 337
Broksonic	317, 319
Canon	308, 309
Citizen	332
Craig	302, 332
Criterion	315
Curtis Mathes	304, 309, 338
Daewoo	309, 312, 341
DBX	314, 336, 337
Dimensia	304
Emerson	316, 317, 318, 319, 320, 341
Fisher	330, 335
Funai	338
General Electric	304, 309, 329
Go Video	322, 339, 340
Goldstar	332
Hitachi	304, 305, 306, 338
Instant Replay	308, 309

Manufacturer	Code
JC Penney	304 305, 309, 314, 330, 336, 337
JVC	314, 336, 337, 345, 346, 347
Kenwood	314, 332, 336, 337
LG	332
LXI (SEARS)	305, 330, 332, 335, 338
Magnavox	308, 309, 310
Marantz	314, 336, 337
Marta	332
Memorex	309, 335
Minolta	304, 305
Mitsubishi/ MGA	323, 324, 325, 326
Multitech	321, 325, 338
NEC	314, 336, 337
Olympic	308, 309
Optimus	327
Orion	317
Panasonic	306, 307, 308, 309
Pentax	304, 305
Philco	308, 309
Philips	308, 309, 310
Pioneer	308
Quasar	306, 308, 309
RCA/ PROSCAN	304, 305, 308, 309, 310, 311, 312, 313, 329
Realistic	309, 324, 328, 330, 335, 338
Sansui	314
Samsung	313, 321, 322
Sanyo	330, 335
Scott	312, 313, 321, 323, 324, 325, 326, 335
Sharp	327, 328
Signature 2000 (M. Ward)	327, 338
SV2000	338
Sylvania	308, 309, 310, 338
Symphonic	338
Tashiro	332
Tatung	314, 336, 337
Teac	314, 336, 337, 338
Technics	308, 309
Toshiba	311, 312
Wards	327, 328, 331, 332, 335
Yamaha	314, 330, 336, 337

Manufacturer	Code
Zenith	331

**Cable Boxes**

Manufacturer	Code
Sony	230
Hamlin/Regal	222, 223, 224, 225, 226
Jerrold/ General Inst./ Motorola	201, 202, 203, 204, 205, 206, 207, 208, 218
Oak	227, 228, 229
Panasonic	219, 220, 221
Pioneer	211, 214, 215
Scientific Atlanta	209, 210, 211
Tocom	216, 217
Zenith	212, 213

**Satellite Receivers**

Manufacturer	Code
Sony	801
Dish Network	810
Echostar	810
General Electric	802
Hitachi	805
Hughes	804
Mitsubishi	809
Panasonic	803
RCA/PROSCAN	802, 808
Toshiba	806, 807

\* If an Aiwa VCR does not work even though you enter the code for Aiwa, enter the code for Sony instead.

## Using Other Equipment with Your Remote Control

To operate other equipment connected to your TV, first turn to page 48 and program the necessary code. For operating video equipment, press TV/VIDEO repeatedly until you see the video input on screen for your connected equipment. Remote control tips are provided below.

### Operating a VCR

To Do This ...	Press
Activate the remote control to operate the VCR	FUNCTION repeatedly until the DVD/VCR indicator lights up.
Turn on/off	SAT/CABLE
Change channels	CH +/-
Record	● REC
Play	⏪

### Operating a Satellite Receiver

To Do This ...	Press
Activate the remote control to operate the satellite receiver	FUNCTION repeatedly until the SAT/CABLE indicator lights up.
Turn on/off	SAT/CABLE
Select a channel	0-9, ENTER
Change channels	CH +/-
Back to previous channel	JUMP

### Operating a Cable Box

To Do This ...	Press
Activate the remote control to operate the cable box	FUNCTION repeatedly until the SAT/CABLE indicator lights up.
Turn on/off	SAT/CABLE

### Operating a DVD Player

To Do This ...	Press
Activate the remote control to operate the DVD	FUNCTION repeatedly until the DVD/VCR indicator lights up.
Turn on/off	SAT/CABLE
Play	⏪
Stop	■

### Operating an MDP (Laserdisc Player)

To Do This ...	Press
Activate the remote control to operate the MDP	FUNCTION repeatedly until the indicator of the position you programmed for the MDP player lights up.
Turn on/off	SAT/CABLE
Play	⏪
Stop	■

To Do This ...	Press
Stop	■
Fast forward	▶▶
Rewind the tape	◀◀
Pause	⏪
Search the picture forward or backward	▶▶ or ◀◀ during playback (release to resume normal playback)

To Do This ...	Press
Display channel number	DISPLAY
Display SAT Index	INDEX
Display SAT Guide	GUIDE
Display SAT Menu	MENU
Move highlight (cursor)	⬆ ⬇ ⬇ ⬆
Select item	⏪

To Do This ...	Press
Select a channel	0-9, ENTER
Change channels	CH +/-
Back to previous channel	JUMP

To Do This ...	Press
Pause	⏪
Step through different tracks of the disc	▶▶ to fast forward or ◀◀ to step backward
Step through different chapters of a video disc	CH+ to fast forward or CH- to step backward

To Do This ...	Press
Pause	⏪
Search the picture forward or backward	▶▶ or ◀◀ during playback (release to resume normal playback)
Search a chapter forward or backward	CH +/-

## Special Buttons on the Remote Control

This TV comes with convenient features that can be accessed using special buttons on the remote control.

### Using the **GUIDE** Button

This TV is equipped to show program information if it is available from the station. The Program Guide lets you review program information, and select both analog and digital channels.

#### To display the Program Guide:

- 1** Tune your TV to a channel by using the 0-9, , and ENTER buttons.
- 2** Press GUIDE on the TV's remote control. The Program Guide will appear with the currently selected program showing in the background.

Channel number, call letters, etc.

Program title and description, program duration, time remaining, rating information, closed-caption availability, etc.

Selectable channel list.

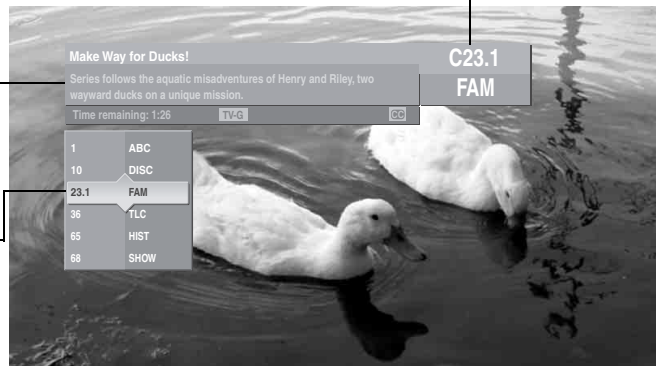



 **Program information in the guide is provided by the broadcasters. As a result, it may sometimes include only the channel number, without a program title or description.**

(Continued)

### Using the Program Guide

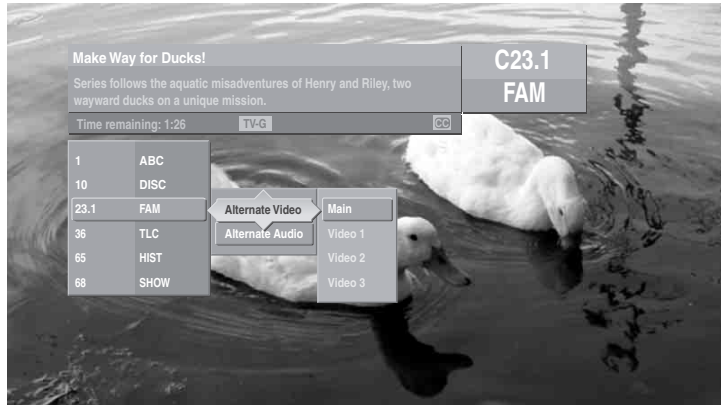
The Program Guide allows you to select the channels from a drop down list. The Guide also provides information about the current program being shown on each channel.



 **Subchannels are additional channels of programming broadcast simultaneously. For example, channel 4 might include three subchannels (4.1, 4.2, 4.3) that are showing programs at the same time.**

### Using the Program Options Setting

The Program Options setting allows you to customize the program settings on the currently tuned channel.

Option	Description
Alternate Video (When available)	Each program has a main video stream (the video that you see when the channel is first tuned), and may have alternate video streams. This option allows you to switch among these alternate video streams.
Alternate Audio (When available)	Each program has a main audio stream (the audio you hear when the channel is first tuned), and may have alternate audio streams. This option allows you to switch among these alternate audio streams (e.g., for different languages).

## Using the WIDE Button

Wide screen mode lets you watch 4:3 normal broadcasts in several wide screen modes (16:9 aspect ratio).

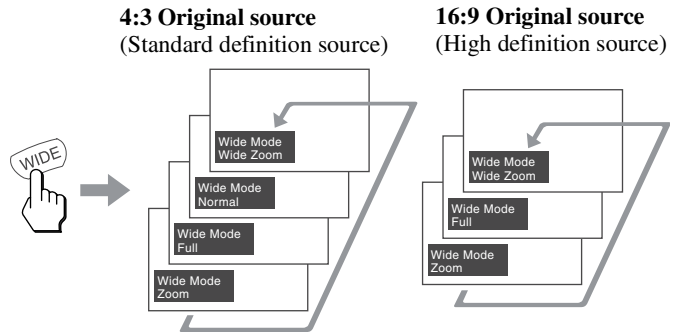

 When the TV receives a 720p or 1080i signal, the Normal Wide Mode setting is not available.

 When the TV receives a 720p or 1080i signal that is 4:3 aspect ratio picture with a black bar at each side, Full returns the picture to its original size.

 You can also access the Wide Mode settings in the Screen settings. For details, see page 88.

### Changing the Wide Mode

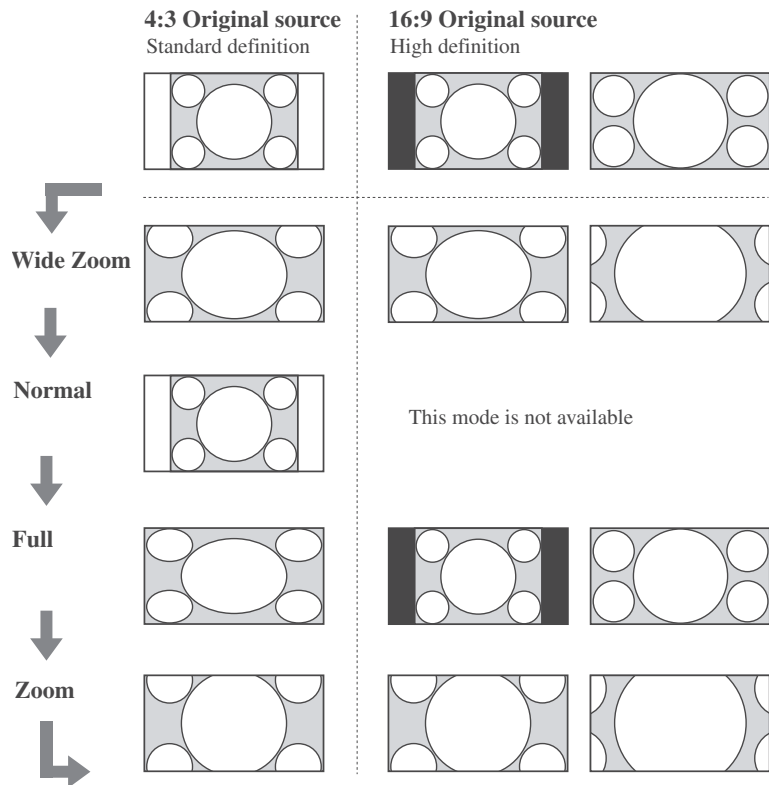

---

**Using the JUMP Button**

The JUMP button allows you to jump back and forth between the current channel and the last channel that was selected.



---

**Using the FREEZE Button**

The FREEZE button allows you to temporarily capture a program's picture. You can use this feature to write down information such as phone numbers, recipes, etc. To cancel FREEZE and return to normal viewing, press the FREEZE button again.

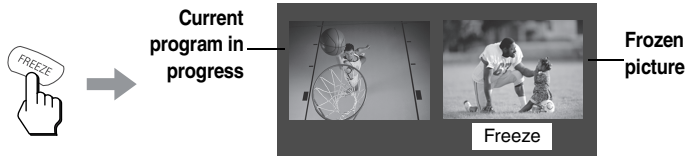

## Using Twin View

Twin View lets you see two pictures from two sources — from an antenna, VCR, DVD, etc. — on the screen at the same time. You hear the sound from only one of the sources at a time, but you can choose which source's sound is selected. You can also change the relative size of each of the pictures.

### Displaying Twin Pictures

#### To display Twin View



**1** Make sure your TV is tuned to a working channel.

**2** Press .

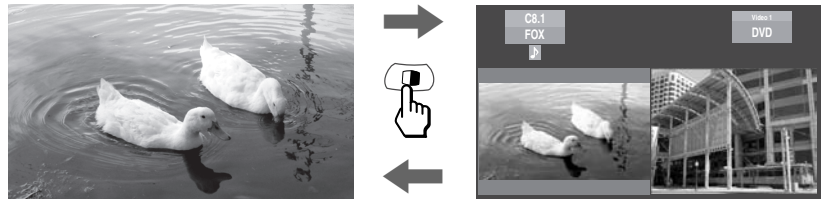

A second picture appears. A  mark appears above the activated picture.



#### To cancel Twin View and watch the active picture

Press  again (or press ).

### Activating the Picture

You can use the  or  buttons to activate the left and right pictures while using Twin View.

#### To activate the right picture

Press .

#### To activate the left picture



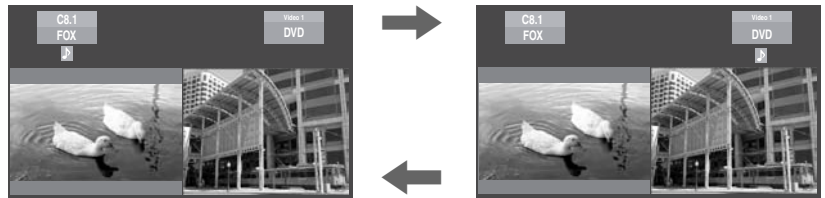

Press .



(Continued)



### Functions available in the active window

To Do This ...	Do This ...
Tune to a channel	To tune to analog channels, press 0-9 and then ENTER. For digital subchannels, press 0-9,  , press 0-9 again, and then ENTER.  For example, to select subchannel 21.13, press 2+1+  +1+3, and then press ENTER.
Adjust the volume	Press VOL +/-.
Mute the sound	Press MUTING (press again or press VOL + to restore the sound).
Switch the TV's input between sources connected to the TV's VHF/UHF and CABLE inputs	Press ANT.
Switch the TV's input between sources connected to the TV's A/V inputs	Press TV/VIDEO.
Change the picture size	Press  or  . (For details, see "Changing the Picture Size" on page 57.)

### Factors Affecting Twin View

- ❑ If you use a cable box to view all channels, the same channel appears in both windows because the cable box unscrambles and sends only one channel at a time. (To view the picture in dual picture features such as Twin View, Freeze, etc., see "Cable Box and Antenna" on page 25.)
- ❑ If you use a cable box and other video equipment, you can view the cable box output in one window and view a different source (such as a VCR or DVD player) in the second window by using the TV/VIDEO button.
- ❑ Digital TV channels, as well as any sources connected to the HD/DVD IN 4-5, and HDMI IN 6-7 inputs display in the left window, but not the right.
- ❑ If you are viewing a 4:3 source and a 16:9 enhanced source (such as a DVD) side by side, the 4:3 source appears larger.
- ❑ Twin View does not display channels that are blocked by parental lock settings (see page 92).

## Changing the Picture Size

The zoom feature lets you change the size of the left and right pictures.

### To enlarge the left picture (reduce the right)

- 1** Press **←** to activate the left picture (if not already activated).
- 2** Press **↑** to enlarge the picture and **↓** to reduce the picture.



### To enlarge the right picture (reduce the left)

- 1** Press **→** to activate the right picture (if not already activated).
- 2** Press **↑** to enlarge the picture and **↓** to reduce the picture.





 When you adjust the picture sizes in Twin View, the TV memorizes the change. The next time you use the Twin View function, the memorized sizes appear.

## Using Favorite Channels

The Favorite Channels feature lets you select programs from a list of up to 16 favorite channels that you specify. You can create a list using the Favorite Channels option in the Channel setting, or by using the Add to Favorites feature in the Favorite Channels guide.

### Using the Channel Menu



 For details on using the Channel setting, see page 90.

- 1** Press MENU to display the setting.
- 2** Press  or  to highlight the Channel icon and press .
- 3** Press  to select Favorite Channels.
- 4** Use the 0-9 and ENTER buttons to enter the channel number that you want to assign to the favorite channel number. A preview of the highlighted channel appears in the upper right of the screen.

 **Digital channels do not display in the preview window.**

Press  to select that channel as a favorite channel.

 **To enter digital channel numbers in step 4, use the 0-9, , 0-9 and ENTER buttons.**

- 5** To add more channels to your favorites list, repeat step 4.  
To clear a favorite channel, press  or  to highlight the channel you want to clear. Press RESET.
- 6** Press MENU to exit the setting.

## Using the Favorite Channels Guide

- 1 Press FAVORITES.

The Favorite Channels list appears.

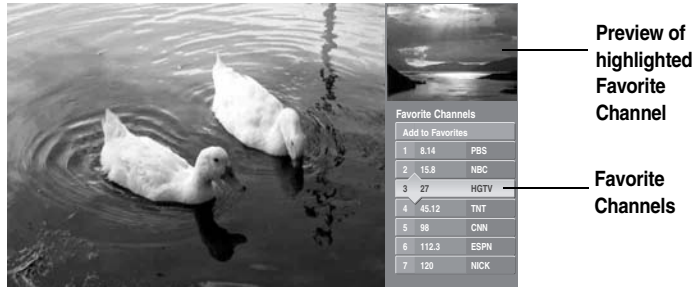

- 2 Press **▲** or **▼** to highlight the channel you want to watch. A preview of the highlighted favorite channel appears.

 **Digital channels do not display in the preview window.**

To add the current channel to the list of Favorite Channels, highlight Add to Favorites and press .

- 3 Press  to select the channel you want to watch.

To change your Favorite Channels list or delete a channel from the list, highlight Edit Favorites and press .

## Using the PC Input

The PC Input feature allows you to connect a personal computer to your TV so you can play PC content through the TV's large display and audio speakers.

 **For details on how to connect a personal computer to your TV, see “Personal Computer” on page 41.**

---

## Displaying the PC Screen

**To display the PC screen:**

- Press TV/VIDEO repeatedly until VIDEO 8 (PC) appears.

 **You can change the settings for the PC input while the TV is displaying the PC screen. For details, see pages 85, 87, and 99.**

**Notes on the PC Input Feature**

- If the i.LINK button on the remote control is pressed while the TV is displaying the PC screen, the following message will appear: Feature Not Available.
- If the Memory Stick button on the remote control is pressed while the TV is displaying the PC screen, the Memory Stick Index will appear on the TV screen.
- Pressing TV/VIDEO repeatedly on the remote control will skip VIDEO 8 (PC) if Twin View is in use.

# Using the Memory Stick Viewer

## About Memory Stick



Memory Stick (sold separately) is a compact, portable, and versatile Integrated Circuit recording medium with a data capacity that exceeds that of a floppy disk. Memory Stick is specially designed for sharing digital data among Memory Stick compatible products such as digital cameras and digital video cameras. Because it is removable, Memory Stick can also be used for external data storage.

### Features

With the Memory Stick Viewer, you can:

- View photo (JPEG) and movie (MPEG1) files in a thumbnail index or Slide Show
- Set customized Slide Show options, including transitions and background audio
- Pan, zoom, and rotate photos
- Mark photos and set quantities of prints to be output when the Memory Stick is inserted into your photo printer (not supplied)
- Lock (protect) or delete files on the Memory Stick

For more information about handling Memory Stick media, see “File Compatibility” on page 62.

### Memory Stick Compatibility

This TV is compatible with the following Sony brand Memory Stick media types:

- Memory Stick Media
- Memory Stick Duo and PRO Duo Media (can be used without the Memory Stick adaptor)

 **CAUTION: The Memory Stick slot on your TV has been designed to accommodate standard and compact versions of Memory Stick. It is not necessary to use an adaptor for Memory Stick Duo and Memory Stick PRO Duo. If you use an adaptor, it may damage the adaptor and Memory Stick slot.**

- Memory Stick Media with Memory Select Function
- Memory Stick PRO Media

#### About Memory Stick PRO Media

Memory Stick PRO media features vary by and are dependent upon the design of host hardware devices. Memory Stick PRO in this TV has been tested to support up to 1 GB media capacity and does not support high-speed transfer, MagicGate copyright protection technology, or access control security features.

---

## File Compatibility

The Memory Stick Viewer is compatible with JPEG images taken with Sony digital still cameras and MPEG1\* movies taken with Sony digital cameras and camcorders. To be viewable in the Memory Stick Viewer, files must have the following file name extensions:

\* Some variations of MPEG1 movies may not play back correctly.

<i>File Type</i>	<i>Supported File Name Extensions</i>
JPEG	.jpg .jpeg
MPEG1	.mpg .mpeg

Most Sony brand digital still and video cameras automatically record still photo and movie files using DCF compliant directory and file names.

If you selected the Digital Camera Folders option, as described on page 69, you might want to have your digital camera's instruction manual handy in order to check how files and directories are organized for your specific model of digital camera.



DCF stands for "Design Rules for Camera File Systems," which are specifications established by the Japan Electronics and Information Technology Industries Association (JEITA: formerly JEIDA).

## Inserting and Removing a Memory Stick/Memory Stick Duo

### Inserting a Memory Stick/Memory Stick Duo

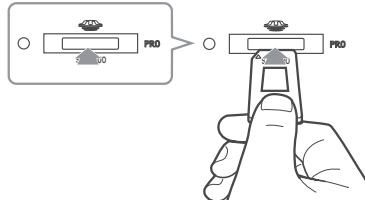
Locate the Memory Stick slot and insert the Memory Stick/Memory Stick Duo into the Memory Stick slot as illustrated below. When inserted properly, it should slide in with little resistance and click into place.



-  **Be sure to insert the Memory Stick/Memory Stick Duo in the correct direction. Forcing the Memory Stick/Memory Stick Duo in the wrong way may result in permanent damage to it and the TV.**
-  **Insert only Memory Stick/Memory Stick Duo media into the Memory Stick slot. Attempting to insert other objects into the Memory Stick slot may damage the TV.**

### Removing a Memory Stick/Memory Stick Duo

- 1** Check that the Memory Stick indicator is off. (When the light is on, this indicates that the TV is reading data from the Memory Stick/Memory Stick Duo.)

 **Removing the Memory Stick/Memory Stick Duo while a file is being accessed (when the Memory Stick indicator on the TV's front panel is lit) may damage the Memory Stick/Memory Stick Duo or its contents.**

- 2** Push the Memory Stick/Memory Stick Duo gently into the Memory Stick slot, and then release it. The Memory Stick/Memory Stick Duo media is ejected.

 **When removing the Memory Stick/Memory Stick Duo, do not attempt to pull it from its slot without first pushing it in to release it.**

- 3** Pull the Memory Stick/Memory Stick Duo completely out of the slot.

 **To protect small children from injury by Memory Stick/Memory Stick Duo media, remove all Memory Stick/Memory Stick Duo media from the TV's Memory Stick slot and store in a safe location when not in use.**

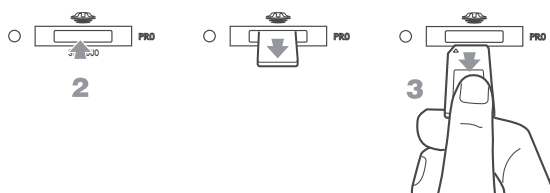









## Viewing Photo or Movie Files

The Memory Stick Index enables you to view all photo or movie files contained in a Memory Stick as thumbnails and let you choose the files you want to display.







- 1 Turn on the TV and insert a Memory Stick that contains the photo or movie files you want to view. The Memory Stick Index appears on the screen.



 If the Memory Stick was inserted before you turn on the TV, the Memory Stick Index will not appear on the screen. Press  on the remote control to display the Memory Stick Index.

- 2 Press     to highlight the photo or movie you want to display.
- 3 Press  to select.

### To display the previous or next page of thumbnails

Press     to select , and press   to change pages.

### To exit Memory Stick Viewer

Press  on the remote control.

### About the Lock and Movie Icons on the Thumbnail Images



Indicates the thumbnail is a movie (MPEG1) file instead of a photo (JPEG) file.



Indicates the thumbnail is locked. Locked files cannot be changed or deleted. For details, see "Protect" on page 67.



Indicates that the photo is marked to be printed.





Indicates that the photo has an associated voice memo.

## Using the Photo Viewer

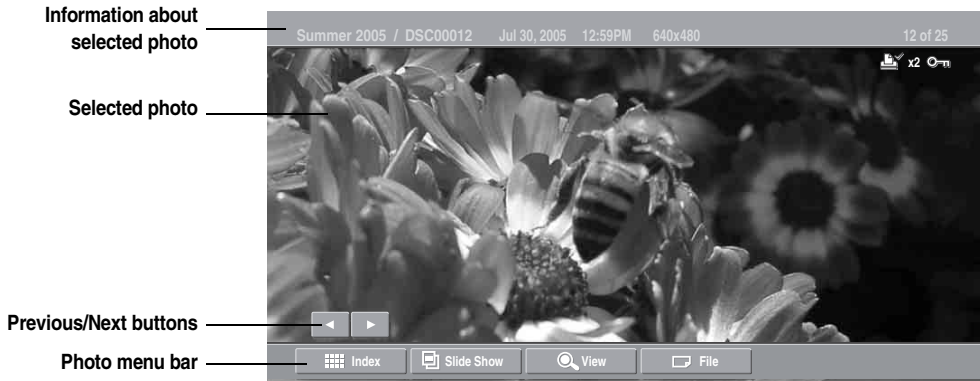
When you select a photo from the Memory Stick Index (described on page 64), it displays as shown below, with the following controls.



 **JPEGs captured using a digital video camera may appear to display motion in full screen. This is a result of the way digital video cameras record still images, and is not a result of a malfunction with the TV.**

 When the menu is hidden, press ◀ or ▶ to go to the previous or next photo.

To Do This ...	Do This ...
Display the previous or next file on the Memory Stick	Press ▲ to highlight the ◀ ▶ (Previous/Next) button. Then press ◀ to go to the previous file, or ▶ to go to the next file.
Hide the Photo menu bar, displaying only the photo	With the highlight in the Photo menu bar, press ▼.
Display the hidden Photo menu bar	Press ▲.
Play the JPEG voice memo (🗣️ files only)	Highlight ▶ (Play) and then press ⏮. To pause the voice memo, highlight ⏸ (Pause) and then press ⏮.
Display the Memory Stick Index again	Press ◀ or ▶ to highlight Index in the Photo menu bar and press ⏮. For details on the Memory Stick Index, see page 64.
Access additional options in the Photo menu bar	See “Using the Menu Bar Options” on page 67.
Exit Memory Stick Viewer	Press ⏻ on the remote control.

## Using the Movie Viewer

When you select a movie from the Memory Stick Index (described on page 64), it displays as shown below, with the following controls.

























 **MPEG movies recorded in VX Fine mode with Sony digital cameras cannot be played back with the Memory Stick Viewer.**

 The quality of the movie when enlarged depends on the resolution of the MPEG1 file. See your camera's instruction manual for details.

To Do This ...	Do This ...
Enlarge the movie window	Press $\uparrow$ or $\downarrow$ to highlight Enlarge, and then press $\left(\begin{smallmatrix} \uparrow \\ \downarrow \end{smallmatrix}\right)$ . To display the movie controls again, press $\left(\begin{smallmatrix} \uparrow \\ \downarrow \end{smallmatrix}\right)$ .
Play the movie with the movie controls displayed	Press $\uparrow$ or $\downarrow$ to highlight $\blacktriangleright$ (Play) and then press $\left(\begin{smallmatrix} \uparrow \\ \downarrow \end{smallmatrix}\right)$ .
Pause the movie	While the movie is playing, the $\blacktriangleright$ button changes to the $\blacksquare\blacksquare$ (Pause) button. Press $\uparrow$ or $\downarrow$ to highlight $\blacksquare\blacksquare$ (Pause) and then press $\left(\begin{smallmatrix} \uparrow \\ \downarrow \end{smallmatrix}\right)$ .
Display the previous or next file on the Memory Stick	Press $\uparrow$ or $\downarrow$ to highlight the $\blacktriangleleft\blacktriangleright$ (Previous/Next) button. Then press $\blacktriangleleft$ to go to the previous file, or $\blacktriangleright$ to go to the next file.
Hide the Movie menu bar, displaying only the movie	With the highlight in the Movie menu bar, press $\downarrow$ .
Display the hidden Movie menu bar	Press $\uparrow$ .
Access additional options in the Movie menu bar	See "Using the Menu Bar Options" on page 67.
Exit Memory Stick Viewer	Press $\left(\begin{smallmatrix} \uparrow \\ \downarrow \end{smallmatrix}\right)$ on the remote control.

## Using the Menu Bar Options

- 💡 JPEG/MPEG1 files that are protected are indicated by the Lock  icon.
- 💡 You cannot rotate a photo that has been protected.
- 💡 Pan is available only when the photo is magnified using Zoom.
- 💡 The Print Quantity feature is also known as DPOF (Digital Print Order Format).

Option	Description
Index	Displays the Memory Stick Index, with the highlight on the currently displayed photo or movie's thumbnail.
Slide Show	Displays the Slide Show menu. For details, see "Slide Show Option" on page 68.
View (only for photo)	<p><b>Rotate</b></p> <p>Allows you to rotate the photo in 90 degree increments clockwise or counterclockwise.</p> <ol style="list-style-type: none"> <li><b>1</b> In the Photo menu bar, press  or  to highlight View.</li> <li><b>2</b> Press  or  to highlight Rotate.</li> <li><b>3</b> To rotate clockwise, press  or  to highlight Clockwise and press . To rotate counterclockwise, press  or  to highlight Counterclockwise and press .</li> </ol> <p>The photo is rotated 90 degrees each time you press .</p>
	<p><b>Zoom/Pan</b></p> <p>Allows you to magnify and pan across the photo.</p> <ol style="list-style-type: none"> <li><b>1</b> In the Photo menu bar, press  or  to highlight View.</li> <li><b>2</b> Press  or  to highlight Zoom/Pan and press .</li> <li><b>3</b> Specify the zoom center point by using    ; then press  to set the center.</li> </ol> <p>Use the arrow buttons to Zoom or Pan, and press  when you want to stop.</p>
File	<p><b>Protect</b></p> <p>Allows you to protect the JPEG/MPEG1 file from any changes. When a JPEG/MPEG1 file is protected, it cannot be rotated (only for JPEG) or deleted. Select On or Off.</p>
	<p><b>Print Quantity</b> (only for photo)</p> <p>Allows you to indicate the number of prints to make of the specific photo when the Memory Stick is inserted into a compatible photo printer (not supplied).</p>
	<p><b>Delete</b></p> <p>Deletes the JPEG/MPEG1 file from the Memory Stick. You cannot delete a JPEG/MPEG1 file that has been protected (or if the Memory Stick is locked).</p>

(Continued)

### Slide Show Option

<i>Option</i>	<i>Description</i>				
Start	Starts the Slide Show.				
Music	Allows you to select background audio to play during the Slide Show.				
Off	No additional background audio is played during the Slide Show. Audio that is associated with the JPEG or MPEG1 files will play.				
Play Memory Stick	Plays all MP3 files on the Memory Stick. The Piano MP3 file is not played.				
Piano (Built-in music)	Plays the MP3 file stored in the TV's internal memory.				
(List of MP3 Files)	Displays a list of all MP3 files found at the top level (root) of the Memory Stick. To show additional MP3 files stored in other folders on the Memory Stick, select <b>Complete list</b> .				
Complete list	Displays a list of all available MP3 files. The list is sorted in alphabetical order, grouped by folder.				
Transition Effect	Allows you to select an effect to be used when advancing to the next file in the Slide Show.				
Slide Advance	Allows you to specify when to advance to the next slide.				
Fast	Slide advances after about 3 seconds.				
Medium	Slide advances after about 6 seconds.				
Slow	Slide advances after about 12 seconds.				
Manual advance	Slide advances only after you press ◀ or ▶.				
File Information	Determines whether file information is displayed. Select <b>On</b> or <b>Off</b> .				
Repeat	<table border="0"> <tr> <td>On</td> <td>Slide Show continuously loops.</td> </tr> <tr> <td>Off</td> <td>Slide Show plays once through all files and ends.</td> </tr> </table>	On	Slide Show continuously loops.	Off	Slide Show plays once through all files and ends.
On	Slide Show continuously loops.				
Off	Slide Show plays once through all files and ends.				

💡 The Slide Show menu is the same whether you select it from the Memory Stick Index (page 64), Photo (page 65), or Movie (page 66) menus.

💡 When you select Complete list, it may take a moment to display the list of all MP3 files.

💡 Some JPEG files may take longer to display than others, which may make it seem longer than the interval you selected for Slide Advance.

**Contents Options**

<i>Option</i>	<i>Description</i>
Select Folder	Allows you to select different folders to view in the Memory Stick Viewer.
Digital Camera Folders	Selects all folders within the directories defined by the DCF rules used by Sony digital cameras (see page 62). JPEG and MPEG1 files in those directories are recognized even if they do not conform to the DCF file naming rules.
Select a Folder	Allows you to access individual folders on the Memory Stick.
File Order	Allows you to change the order in which the Memory Stick files are displayed.
Date Order	Displays files in chronological order by modification date.
Date Order Reverse	Displays files in reverse chronological order by modification date.
Alphabetical	Displays files in alphabetical order by filename.
Filter	Allows you to selectively display specific file types within the selected folder.
Show Photos and Movies	Displays all readable files.
Show Photos Only	Displays only photo (JPEG) files.
Show Movies Only	Displays only movie (MPEG1) files.
Show All Print Marks	Displays all files marked with the Print Mark feature, regardless of the currently selected folder. For details, see “Print Quantity (only for photo)” on page 67.

 The Rotate and Protect functions do not change the file's modification date.

**Memory Stick Options**

The Memory Stick menu displays the current status of the Memory Stick, including total capacity, used capacity, and free capacity.

## Memory Stick Precautions

When using Memory Stick media, follow these precautions:

- To avoid permanent damage to still image data, do not turn off the TV or remove Memory Stick media from the insertion slot while data is being read (as indicated by the Memory Stick indicator light being on).
- Avoid touching the terminal of Memory Stick media or bringing it into contact with a metal object.
- Do not drop, bend, or submit Memory Stick media to external shock.
- Do not disassemble or modify Memory Stick media.
- Avoid getting liquid on Memory Stick media.
- Apply labels only within the designated label area.

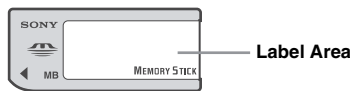

- To avoid permanent damage to still image data, do not use or store Memory Stick media in a location subject to:
  - High temperature (such as near a heater or inside a hot car)
  - High humidity
  - Direct sunlight
  - Corrosive substances
  - Magnetic fields
  - Excessive dust
  - Static electricity or electric noise
  - Electric surges
- Store and carry Memory Stick media in its original case to ensure protection of stored data.
- Save a backup of stored data.
- When using the Memory Stick Duo, insert it without using the Memory Stick Duo adaptor. For details, see page 63.

---

## Memory Stick Functionality

Sony cannot guarantee or assure the Memory Stick functionality on this TV in the following cases:

- You are using non-Sony brand Memory Stick media.
- You are using video or audio clips that have been processed on a computer.
- You are using files that were obtained from the Internet or from a printed film processing center.
- The Memory Stick has been formatted on a personal computer.

Sony recommends that you back up all data stored on Memory Stick media to avoid potential data loss. In the above cases, in order to avoid potential data corruption, be sure to back up data prior to use with the TV's Memory Stick Viewer. Sony cannot accept responsibility in the event that data recorded to Memory Stick media is lost or damaged. For certain non-Sony brand Memory Stick media, you can view images, but you cannot rotate, delete or protect/unprotect images on the TV. An error message will occur if you attempt any of these operations. This is a result of the unique file directory structure on these particular flash memory media and is not a malfunction of the TV.





# Using i.LINK

## Connecting i.LINK Devices

This TV has three S400 i.LINK terminals (one on the front panel, and two on the back panel). You can use the following i.LINK cables with this TV:

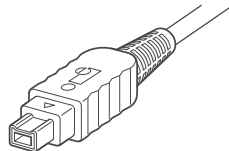

4-pin i.LINK cable

Sony Model	Length
VMC-IL4415	1.5 meters
VMC-IL4435	3.5 meters

 **Do not use cables other than the ones listed above.**

i.LINK provides a secure digital interface to other digital home entertainment devices, such as digital VCRs, digital camcorders, set-top boxes, and other devices that also are equipped with i.LINK. i.LINK allows for the secure transfer of copyright-protected digital content between these devices and your digital television.

All products with an i.LINK connector may not communicate with each other.

 **Before connecting this unit to i.LINK-compatible equipment, read the instruction manual of the i.LINK device to be connected.**

### To connect a digital i.LINK device (using only a digital signal)

- 1** Using an i.LINK cable, connect the device's i.LINK jack to any of the TV's i.LINK jacks.

### To connect an i.LINK device that supports an EIA-775A connection

- 1** Using an i.LINK cable, connect the device's i.LINK jack to any of the TV's i.LINK jacks.
- 2** Using an A/V cable, connect the i.LINK device's A/V output jacks to the TV's VIDEO 3 A/V input jacks.

 **Only one i.LINK cable should connect the TV and any given i.LINK device.**

(Continued)

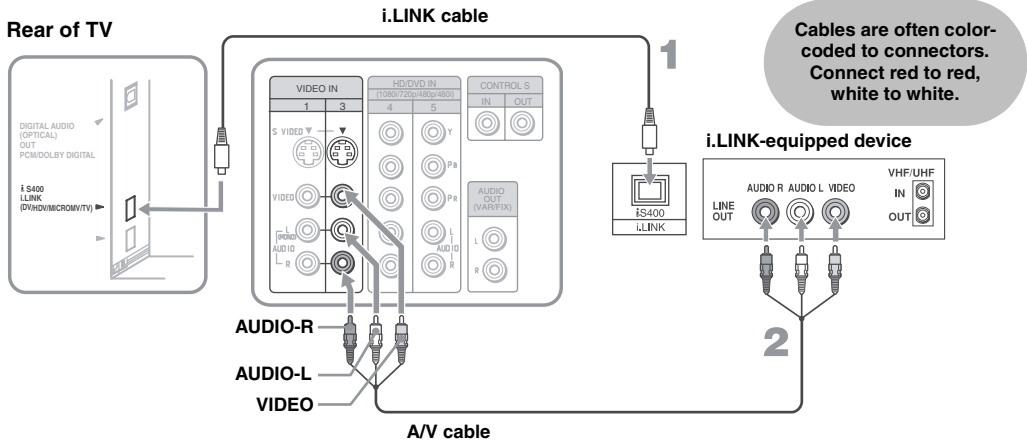

**Notes on Using This Connection**

To Do This ...	Do This ...
----------------	-------------

Set up a digital i.LINK device	For digital i.LINK devices (devices that require only the i.LINK connection), no setup is necessary. The TV automatically recognizes the device as soon as the connection is made.
--------------------------------	--

Set up an i.LINK device	<b>1</b> Connect analog A/V cables to the VIDEO 3 input (see page 73).
Use the i.LINK Control Panel to activate the analog connection	<b>2</b> Use the i.LINK Control Panel to activate the analog connection to your i.LINK device (see page 75).

**Notes on Connecting i.LINK Devices**

To connect two or more i.LINK devices, use i.LINK cables to connect them as shown below.

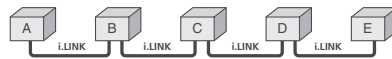

You can connect up to 63 i.LINK devices. However, the maximum number of cables in any serial route is 16.

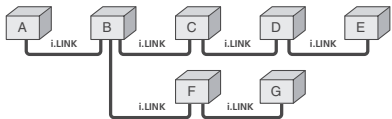

Do not connect i.LINK devices in a way that creates a loop.

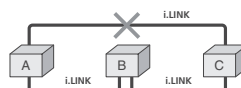

Connecting non-compatible devices, such as PCs or PC peripherals, may result in malfunctions.

## Selecting an i.LINK Device

Before an i.LINK device can be viewed, it must first be selected via the i.LINK Device List.

- 1 Connect the i.LINK device that you wish to operate.

 **For instructions on connecting i.LINK devices, see page 73.**

- 2 Press i.LINK on the media receiver unit or the remote control.

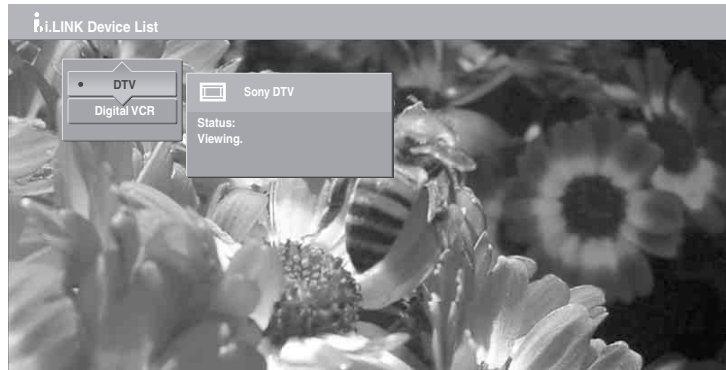

The TV (DTV), along with all devices connected by i.LINK to the TV, appear on the i.LINK Device List.

Devices that are not supported by the TV appear on the Device List as “Other Device,” but cannot be controlled using the TV’s remote control or on-screen i.LINK Control Panel. For these devices, use the remote control supplied with the device.

- 3 Press **▲** or **▼** to navigate among the i.LINK-connected devices.



 **i.LINK devices can be connected to one another and to the TV while the TV is powered on. The Device List will automatically update to include the newly connected device. See page 73 for more information on connecting i.LINK devices.**





- 4 Press **⊙** to select the desired device and display the device’s i.LINK Control Panel. Use the i.LINK Control Panel to operate the selected device. For details, see page 76.

## Using the i.LINK Control Panel

After you select an i.LINK device using the Device List, the TV displays the i.LINK Control Panel, which allows you to use the TV's remote to control the selected i.LINK device.

- 1** If the i.LINK Control Panel is not already displayed, press i.LINK on the remote control.

 **If i.LINK is pressed while the TV is displaying an analog or digital channel (not the i.LINK device), then the Device List will appear. Select the desired device from the list and press  to display the Control Panel.**

- 2** Press     on the remote control to navigate through the options available in the i.LINK Control Panel.
- 3** Press  to select a desired option.
- 4** Press EXIT to exit the Control Panel and view the i.LINK device in full-screen.

 **To exit i.LINK mode, select DTV from the Device List or press CH +/-.**

The DTV window appears only if the i.LINK menus were entered while watching a digital TV channel

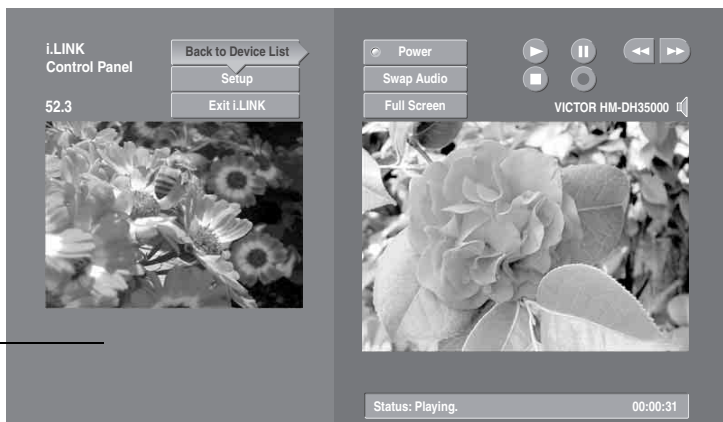

The i.LINK Control Panel displays the signal from the TV to the left on screen (if available), and the signal from the currently selected device to the right on screen.

To Do This ...	Do This ...
Go to the Device List	Press     to highlight Back to Device List and press .
Change the audio being played from the TV to the current selected device, and vice versa	Press     to highlight Swap Audio and press . An icon appears next to the window that currently has sound.
Play a recording from the selected i.LINK camcorder or digital VCR	Press     to highlight  and press .
Fast-forward or rewind a recording from the selected i.LINK camcorder or digital VCR	Press     to highlight  or  and press .
Record from TV to the selected i.LINK digital VCR	If the  (Record) button is available, press     to highlight  and press .
Stop a recording from the selected i.LINK digital VCR	Press     to highlight  and press .
Turn the selected device power on and off	Press     to highlight Power and press .
Setup the selected device	Press     to highlight Setup and press . For more details on Setup, see page 78.

### Notes About Controlling i.LINK Devices

- You can control the functions of the selected i.LINK device by using the equivalent buttons on the TV's remote control. To program the remote control to operate i.LINK devices, see "Programming the Remote Control" on page 48.
- Some options on the i.LINK Control Panel may not be available, depending on the device being controlled.
- Only i.LINK-equipped digital camcorders and digital VCRs can be controlled directly through the i.LINK Control Panel.
- Not all functions are supported for all i.LINK devices.
- If you are using a digital VCR, turn off any Auto LINC functionality of the VCR. For details, see the digital VCR's user manual.

## i.LINK Setup

You can use the i.LINK Control Panel to access digital setup options, some of which are also available through the Program Guide (described on page 52).

### To set up the selected device:

Press **▲ ▼ ◀ ▶** to highlight Setup and press **⏏**.

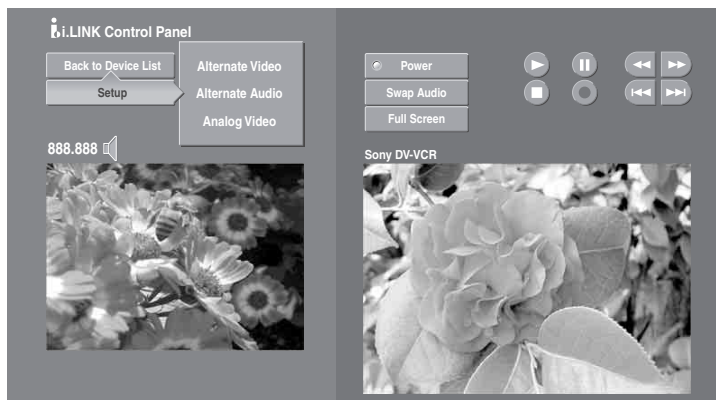

The following options are displayed:

Option	Description
Alternate Video (when available)	Each program has a main video stream (the video that you see when the channel is first tuned), and may have alternate video streams. This option allows you to switch among these alternate video streams.
Alternate Audio (when available)	Each program has a main audio stream (the audio that you hear when the channel is first tuned), and may have alternate audio streams. This option allows you to switch among these alternate audio streams (e.g., for different languages).
Analog Video	The TV is able to accept an analog signal from a selected set-top box. The set-top box must be EIA-775A compliant and must be connected to the TV's VIDEO 3 input. To associate the device with the TV's analog VIDEO 3 input, press <b>▲</b> or <b>▼</b> to select <b>Analog Video</b> and press <b>⏏</b> . All EIA-775A-compliant devices will be shown in the list. Select the desired device from the list and press <b>⏏</b> .

### Notes on i.LINK

- ❑ The TV can act as an i.LINK repeater, so that i.LINK signals are relayed to another device even when the TV is powered off. To enable this feature, set the i.LINK Standby option to On using the Setup setting as described on page 97.
- ❑ Parental Lock settings apply to the signal from a selected device. For more details, see page 92.

# Using the Settings

## Overview

### The Settings give you access to the following features:

(Depending on the signal tuned, you may see different Setting options on your screen. Settings displayed here are with the 720p signal.)

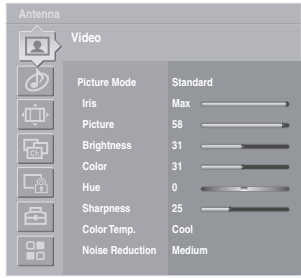
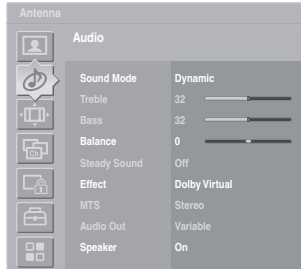
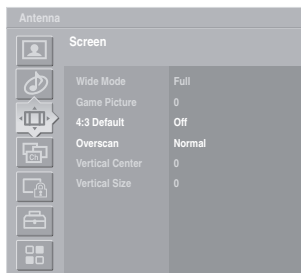
<b>Settings</b>	<b>Allows you to set/change</b>	
<p><b>Video</b></p> 	<ul style="list-style-type: none"> <li>Picture Mode (page 81)</li> <li>Iris (page 81)</li> <li>Picture (page 81)</li> <li>Brightness (page 81)</li> <li>Color (page 81)</li> <li>Hue (page 81)</li> <li>Sharpness (page 81)</li> <li>Color Temp. (page 82)</li> <li>Noise Reduction (page 82)</li> <li>Direct Mode (page 82)</li> </ul>	<ul style="list-style-type: none"> <li>Game Mode (page 82)</li> <li>Advanced Video (page 82)</li> </ul>
<p><b>Audio</b></p> 	<ul style="list-style-type: none"> <li>Sound Mode (page 86)</li> <li>Treble (page 86)</li> <li>Bass (page 86)</li> <li>Balance (page 86)</li> <li>Steady Sound (page 86)</li> <li>Effect (page 86)</li> <li>MTS (page 87)</li> <li>Audio Out (page 87)</li> <li>Speaker (page 87)</li> </ul>	
<p><b>Screen</b></p> 	<ul style="list-style-type: none"> <li>Wide Mode (page 88)</li> <li>Game Picture (page 88)</li> <li>4:3 Default (page 89)</li> <li>Overscan (page 89)</li> <li>Vertical Center (page 89)</li> <li>Vertical Size (page 89)</li> </ul>	



(Continued)

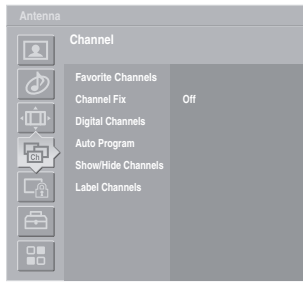
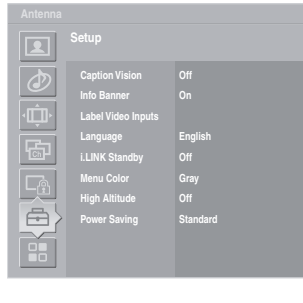
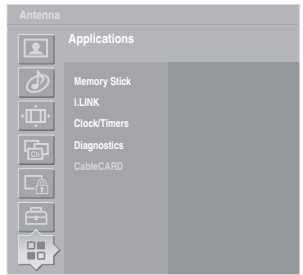

## Using the Settings

<b>Settings</b>	<b>Allows you to set/change</b>
<p><b>Channel</b></p> 	<ul style="list-style-type: none"><li>Favorite Channels (page 90)</li><li>Channel Fix (page 90)</li><li>Digital Channels (page 90)</li><li>Auto Program (page 90)</li><li>Show/Hide Channels (page 91)</li><li>Label Channels (page 91)</li></ul>
<p><b>Parental Lock</b></p> 	<ul style="list-style-type: none"><li>Parental Lock (page 92)</li><li>Change Password (page 93)</li><li>Select Country (page 93)</li></ul>
<p><b>Setup</b></p> 	<ul style="list-style-type: none"><li>Caption Vision (page 96)</li><li>Info Banner (page 96)</li><li>Label Video Inputs (page 96)</li><li>Language (page 97)</li><li>i.LINK Standby (page 97)</li><li>Menu Color (page 97)</li><li>High Altitude (page 97)</li><li>Power Saving (page 97)</li></ul>
<p><b>Applications</b></p> 	<ul style="list-style-type: none"><li>Memory Stick (page 101)</li><li>i.LINK (page 101)</li><li>Clock/Timers (page 101)</li><li>Diagnostics (page 102)</li><li>CableCARD (page 102)</li></ul>

## Accessing the Video Settings

1. Press MENU..... 
2. Highlight..... 
3. Press to select ..... 

To highlight an option and to change settings, press  $\uparrow$   $\downarrow$   $\leftarrow$   $\rightarrow$ .

Press  $\text{ENTER}$  to confirm the selection.

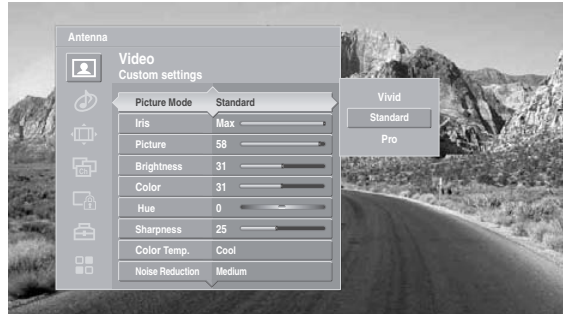

To exit the Video settings, press  $\text{MENU}$ .



### Selecting Video Options

 To quickly and easily change from one Picture Mode to another, use PICTURE on the remote control.

The Video settings include the following options:

Option	Description
Picture Mode	<p><b>Vivid</b> Select for enhanced picture contrast and sharpness.</p> <p><i>Customized picture viewing</i></p> <p><b>Standard</b> Select for standard picture settings. Recommended for home entertainment.</p> <p><b>Pro</b> Select to display a picture with minimum enhancements.</p>
<p> <b>You can alter the Video settings (Picture, Brightness, Color, etc.) for each Picture Mode and each video input.</b></p> <p> <b>You can set up a Picture Mode (Vivid, Standard, Pro) independently for each Video input (Video 1-Video 7, including the Antenna input). Your Picture Mode settings are automatically saved after each selection. This allows you to customize the Picture Mode setting for each type of signal source.</b></p>	
Iris	Adjust the contrast levels.
Picture	Adjust to increase picture contrast and deepen the color or decrease picture contrast and soften the color.
Brightness	Adjust to brighten or darken the picture.
Color	Adjust to increase or decrease color intensity.
Hue	Adjust to increase or decrease the green tones.
Sharpness	Adjust to sharpen or soften the picture.

(Continued)

 Direct Mode and Game Mode are not available when watching 480p and 720p sources, or when using multi-picture functions (Twin View, Freeze, or Memory Stick).

Option	Description	
Color Temp. <i>White intensity adjustment</i>	Choose from three color temperatures:	
	Cool	Select to give the white colors a blue tint.
	Neutral	Select to give the white colors a neutral tint.
	Warm	When Pro is selected in Picture Mode, select to give the white colors a red tint.
Noise Reduction	Select to reduce the noise level of connected equipment. This also reduces the noise level to the signal from the VHF/UHF jack. Select from High, Medium, Low and Off.	
Direct Mode	On	Select for a natural, soft picture.
	Off	Select to turn off the Direct Mode.
Game Mode	On	Select to optimize the lipsync when playing games.
	Off	Select to turn off the Game Mode.
Advanced Video <i>Available in "Custom Picture Mode"</i>	Select Program to choose among the options described below.	
	DRC Mode	Creates a high-resolution picture with 4 x density, for high quality sources (i.e., DVD player, satellite receiver).
	Mode 1	Recommended for moving pictures.
	Mode 2	Recommended for still images and text.
	CineMotion	Provides an optimized display by automatically detecting film content and applying a reverse 3-2 pulldown process. Moving pictures will appear clearer and more natural-looking.

 **DRC Mode is not available when using multi-picture functions (Twin View, Freeze or Memory Stick), or when Direct Mode is set to On or Game Mode is set to On; also not available when watching 480p or 720p sources.**

Option	Description
Advanced Video (Continued)	DRC Palette Allows you to customize the level of detail (Reality) and smoothness (Clarity) for up to three input sources. For example, you can create one Custom setting to optimize your cable input's picture, and create another to optimize your DVD player's picture. You can switch among the three Custom settings.

- 1 Press the arrow buttons to highlight Custom 1, Custom 2, or Custom 3 and then press . The DRC palette appears.

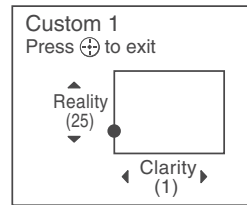



- 2 Press the arrow buttons to adjust the position of the marker (●). As you move the ● higher along the Reality axis, the picture becomes more detailed. As you move the ● to the right along the Clarity axis, the picture becomes smoother.
- 3 To save the setting, press .

To return the Custom options to the default factory settings, press the RESET button.

 **DRC Palette is not available when watching 480p and 720p sources, using multi-picture functions (Twin View, Freeze or Memory Stick), or when Direct Mode is set to On or Game Mode is set to On.**

BN Smoother Select to reduce noise caused by digital video encoding and decoding process. It is especially effective for watching a DVD or digital TV picture. Select from High, Medium, Low and Off.

 **BN Smoother may not be effective for some connected equipment.**

 **BN Smoother is not available when watching 480p, 720p, and 1080i sources, or when using multi-picture functions (Twin View, Freeze or Memory Stick).**

Advanced Iris Allows you to enhance the black color in dark images by controlling the iris automatically and improves its contrast by increasing the amplitude of the image.

 The following settings are available, when Picture Mode is set to Pro; Advanced Iris, Color Corrector, DTE, Clear White, Detail Enhancer, Black Corrector, Gamma Corrector, White Balance.

(Continued)

<b>Option</b>	<b>Description</b>
<b>Advanced Video</b>	<b>Color Corrector</b> Select to make the colors more vivid. Select from High, Low, and Off.
<i>(Continued)</i>	<b>DTE</b> Select to enhance the texture of the picture. Select from High, Medium, Low, and Off.
	<b>Clear White</b> Select to emphasize the white colors. Select from On or Off.
	<b>Detail Enhancer</b> Select to sharpen picture definition. Select from High, Medium, Low, and Off.
	<b>Black Corrector</b> Select to enhance the black colors to give the picture strong contrast. Select from High, Medium, Low, and Off.
	<b>Gamma Corrector</b> Select to adjust the balance between bright and dark areas of the picture. Select from High, Medium, Low, and Off.
	<b>White Balance</b> Select to fine-adjust the white color intensity by changing the red, green and blue levels. Select Adjust to choose among the R-Gain, G-Gain, B-Gain, R-Bias, G-Bias, and B-Bias options. To restore the factory default setting of White Balance, select Initial Set.

---

## Selecting PC Video Options

To display the PC screen:

- ❑ See “Using the PC Input” on page 60.

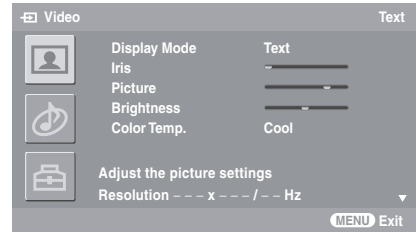



The PC Input Video setting includes the following options:

<i>Option</i>	<i>Description</i>
Display Mode	<b>Video</b> Select to view video images.
	<b>Text</b> Select to view text, charts or tables.
Iris	Adjust the contrast levels.
Picture	Adjust to increase or decrease picture contrast.
Brightness	Adjust to brighten or darken the picture.
Color Temp.	Choose from three color temperatures:
	<b>Cool</b> Select to give the white colors a blue tint.
	<b>Neutral</b> Select to give the white colors a neutral tint.
Reset	<b>Warm</b> Select to give the white colors a red tint.
	Select to restore the factory default settings.



## Accessing the Audio Settings

1. Press MENU..... 
2. Highlight..... 
3. Press to select..... 

To highlight an option and to change settings, press  $\uparrow$   $\downarrow$   $\leftarrow$   $\rightarrow$ .

Press  $\text{ENTER}$  to confirm the selection.

To exit the Audio settings, press  $\text{MENU}$ .

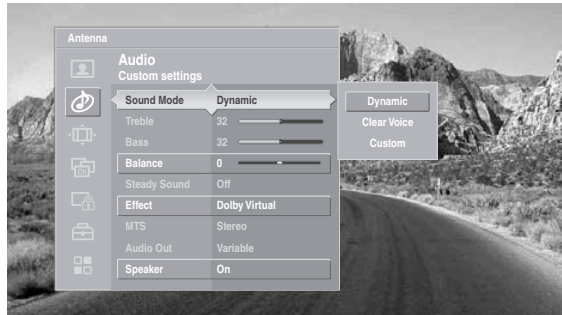



### Selecting Audio Options

 Treble/Bass setting is available only when Sound Mode is set to Custom.

 TruSurround attempts to create the same surround effect produced by a multichannel system using the left and right speakers.

The Audio settings include the following options:

Option	Description
Sound Mode	Dynamic Select to enhance treble and bass.
	Clear Voice Suitable for spoken dialog.
	Custom Flat setting.
Treble	Adjust to increase or decrease higher-pitched sounds.
Bass	Adjust to increase or decrease lower-pitched sounds.
Balance	Adjust to emphasize left or right speaker balance.
Steady Sound	Auto Select to stabilize the volume across all programs and commercials.
	Off Select to turn off Steady Sound.
<b> Steady Sound is not available when Effect is set to Dolby Virtual, TruSurround or Simulated.</b>	
Effect	Dolby Virtual Select for surround sound (for Dolby surround encoded programs only).
	TruSurround Select for surround sound (for stereo programs only).
	Simulated Adds a surround-like effect to mono programs.
	Off Normal stereo or mono reception.

Option	Description	
MTS <i>Enjoy stereo, bilingual and mono programs</i>	Stereo	Select for stereo reception when viewing a program broadcast in stereo.
	Auto SAP	Select to automatically switch to second audio programs when a signal is received. (If no SAP signal is present, the TV remains in Stereo mode.)
	Mono	Select for mono reception. (Use to reduce noise during weak stereo broadcasts.)
 <b>MTS is available only for analog programs.</b>		
Audio Out <i>Easy control of volume adjustments</i>	This option can be set only when the <b>Speaker</b> option is set to <b>Off</b> .	
	Variable	The TV's speakers are turned off, and the audio output from your audio system can still be controlled by the TV's remote control.
	Fixed	The TV's speakers are turned off, and the audio output of the TV is fixed. Use your audio receiver's volume control to adjust the volume (and other settings) through your audio system.
Speaker	On	Select to turn on the TV speakers.
	Off	Select to turn off the TV speakers and listen to the TV's sound only through your external audio system speakers.

## Selecting PC Audio Options

 RESET button does not operate when PC Audio options is selected.

### To display the PC screen:

- See "Using the PC Input" on page 60.

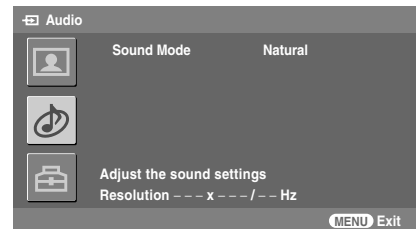



The PC Input Audio setting includes the following option:

Option	Description	
Sound Mode	Dynamic	Select to enhance treble and bass.
	Clear Voice	Suitable for spoken dialog.
	Natural	Flat setting.



## Accessing the Screen Settings

1. Press MENU..... 
2. Highlight..... 
3. Press to select..... 

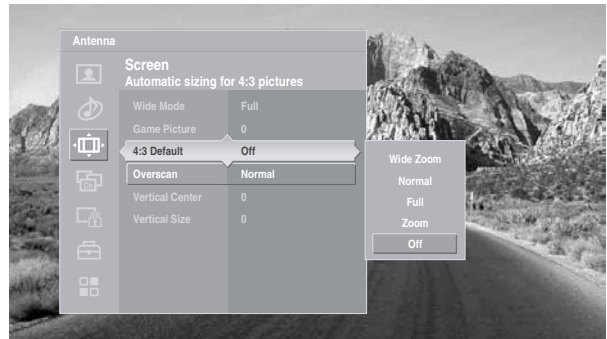

To highlight an option and to change settings, press **↑ ↓ ← →**.  
 Press **⏏** to confirm the selection.  
 To exit the Screen settings, press **MENU** .





### Selecting Screen Options

 Wide Mode is not available when using the Freeze function (page 54).



The Screen settings include the following options:

Option	Description
Wide Mode	Wide Zoom Select to enlarge the 4:3 picture, to fill the 16:9 screen, keeping the original image as much as possible.
Normal	Select to return the 4:3 picture to its original size and aspect ratio.
 <b>Normal is not available when you are watching 720p or 1080i sources.</b>	
Full	Select to enlarge the 4:3 picture horizontally only, to fill the display area.
Zoom	Select to enlarge the 4:3 picture horizontally and vertically to an equal aspect ratio that fills the wide screen.
 <b>To change from one Wide Mode setting to another, use the WIDE button on the remote control (see page 46).</b>	
Game Picture	Allows you to move the position of the picture left and right in the window. (This feature also allows you to adjust the picture from any connected equipment.) Select while watching the picture to be adjusted. The TV stores the position in memory for each input.  Press <b>←</b> or <b>→</b> and press <b>⏏</b> to choose a correction between +10 and -10.

💡 If 4:3 Default is set to anything but Off, the Wide Mode setting changes only for the current channel. When you change channels (or inputs), Wide Mode is automatically replaced with the 4:3 Default setting. To retain the current Wide Mode setting as channels and inputs are changed, set 4:3 Default to Off.

Option	Description
4:3 Default <i>Select the default screen mode to use for 4:3 sources.</i>	Wide Zoom Select to enlarge the 4:3 picture, to fill the 16:9 screen, keeping the original image as much as possible.
	Normal Select to return the 4:3 picture to normal mode.
	Full Select to enlarge the 4:3 picture horizontally only, to fill the display area.
	Zoom Select to enlarge the 4:3 picture horizontally and vertically to an equal aspect ratio that fills the wide screen.
	Off Select to continue using the current screen mode setting when the channel or input is changed.
Overscan	Normal Select to display the picture within the normal viewing area of the screen.
	+1 or +2 Select to reduce the size of the picture to show the overscan (i.e. the portion of the picture outside of the normal viewing area).
Vertical Center	Allows you to move the position of the picture up and down in the window. (Available only in Zoom and Wide Zoom mode.) Press <b>▲</b> or <b>▼</b> and press  to choose a correction between +10 and -10.
Vertical Size	Allows you to adjust the vertical size of the picture. (Available only in Zoom and Wide Zoom mode.) Press <b>▲</b> or <b>▼</b> and press  to choose a correction between +10 and -10.

## Accessing the Channel Settings

1. Press MENU..... 
2. Highlight..... 
3. Press to select..... 

To highlight an option and to change settings, press **↑ ↓ ← →**.

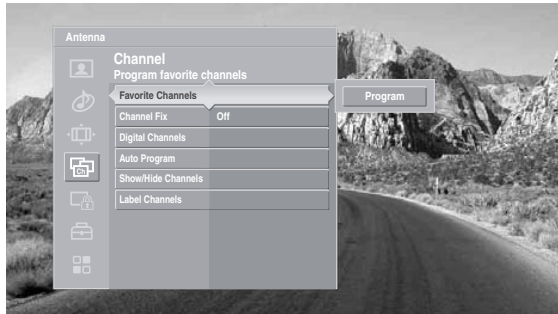

Press **⏏** to confirm the selection.

To exit the Channel settings, press **MENU** .

















### Selecting Channel Options



The Channel settings include the following options:

Option	Description
<b>Favorite Channels</b>	Lets you set up a list of your favorite channels. For details, see “Using Favorite Channels” on page 58.
<b>Channel Fix</b>	Off Turns off Channel Fix.
<i>Useful when you have a cable box or satellite receiver connected</i>	2-6 “Fix” your TV’s channel setting to one channel (2-6) and use the cable box, VCR or satellite receiver to change channels. Select one of these settings if you have connected the device to the VHF/UHF jack.
	C2–C6 “Fix” your TV’s channel setting to C2–C6 (CABLE input) and use the cable box or satellite receiver to change channels.
	Video 1, 4 Use when connecting a cable box. TV output should be connected through the cable box.
<b>Digital Channels</b>	Add Automatically adds the channel list on the TV for all receivable digital channels for current input. Select to start the Add.
<b>Auto Program</b>	Automatically sets up the channel list on the TV for all receivable channels for the current input (VHF/UHF or CABLE). Select to start the Auto Program.
	 <b>Auto Program may take between 20-50 minutes to complete. A progress bar will display the approximate progress of the Auto Program and Digital Channels/Add sequences.</b>
	 <b>Auto Program will create a list of receivable channels for the current input (VHF/UHF antenna or CABLE). You will be required to run Auto Program for each RF input to create a list of available channels from both inputs.</b>

 Channels that you set to Hidden can only be accessed with the 0-9 buttons.

Option	Description
Show/Hide Channels	<p>Allows you to show or hide channels that appear in the Program Guide and when you use the CH+/- buttons to channel surf. Channels that are set to Hidden do not appear in the Program Guide or when you use the CH+/- buttons.</p> <ol style="list-style-type: none"> <li><b>1</b> Press  or  to highlight the channel that you want to show or hide. <ul style="list-style-type: none"> <li>To move between the Major and Digital subchannel lists, press  or .</li> </ul> </li> <li><b>2</b> To change a channel's setting to Shown or Hidden, press .</li> <li><b>3</b> To show or hide more channels, repeat steps 1 and 2.</li> </ol>
<p> <b>If you select to hide or show a major digital channel, all the sub-channels are automatically hidden or shown. To show or hide an individual sub-channel within a digital channel, you must individually select that sub-channel to show or hide.</b></p> <p> <b>If you hide all sub-channels of a major digital channel, that digital channel is automatically set to Hidden.</b></p>	
Label Channels	<p>Allows you to assign labels (such as station call letters) to channel numbers.</p> <ol style="list-style-type: none"> <li><b>1</b> Press  or  to scroll through the channel numbers. Then press  to select the channel number that you want to assign a label.</li> <li><b>2</b> Press  or  to scroll through the label characters (A-Z, 0-9, etc.). Then press  to select the highlighted character. Repeat to add characters to the label.</li> <li><b>3</b> Press  to return to the Channel setting, or press MENU to exit the settings.</li> </ol>

## Accessing the Parental Lock Settings

1. Press MENU..... 
2. Highlight..... 
3. Press to select..... 

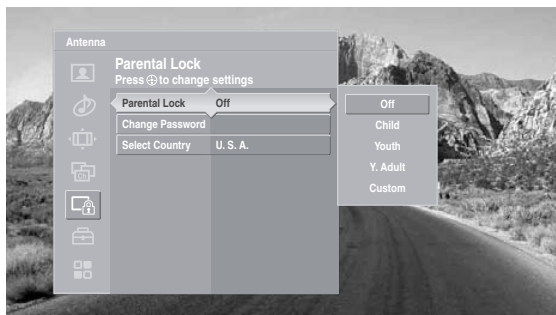

To highlight an option and to change settings, press  $\uparrow$   $\downarrow$   $\leftarrow$   $\rightarrow$ .

Press  to confirm the selection.

To exit the Parental Lock settings, press .

The Parental Lock setting allows you to set up the TV to block programs according to their content and rating levels.

 **You need your password for any future access to the Parental Lock settings. If you have lost your password, see “Lost password.” on page 113.**

### Selecting Parental Lock Options

The Parental Lock settings include the following options:

Option	Description
Parental Lock <i>Turn ratings on/off and select a rating system</i>	Off Turn Parental Lock off. No programs are blocked from viewing.
Child	Maximum ratings permitted are: U.S.: TV-Y, TV-G, G Canada: C, G, TV-Y
Youth	Maximum ratings permitted are: U.S.: TV-PG, PG Canada: C8+, PG, 8 ans+, TV-PG
Y. Adult	Maximum ratings permitted are: U.S.: TV-14, PG-13 Canada: 14+, 13 ans+, TV-14
Custom	Select to set ratings manually. U.S.: See page 94 for details. Canada: See page 95 for details.

 If you are not familiar with the Parental Guideline rating system, you should select Child, Youth, or Y.Adult to help simplify the rating selection. To set more restrictive ratings, select Custom.

<i>Option</i>	<i>Description</i>
Change Password	Select to change your password.
Select Country	U.S.A.    Select to use U.S.A. ratings (see page 94).
	Canada    Select to use Canadian ratings (see page 95).

### To deactivate the parental control feature

- Set Parental Lock to Off when in the Parental Lock setting.

### To change the password

- 1** In the Parental Lock setting, use the arrow buttons to highlight Change Password, and press  to select it.
- 2** Enter a new four-digit password using the 0-9 buttons.
- 3** Confirm the new password by entering it again.
- 4** Press MENU to exit the setting screen.

 For descriptions of Child, Youth, and Y.Adult ratings, see page 92.

## Viewing Blocked Programs

You can view a blocked program by entering the password.

- 1** Press ENTER when tuned to a blocked program.
- 2** Enter your password using the 0-9 buttons.  
Parental Lock will be canceled temporarily until you turn your TV off.

## Selecting Custom Rating Options

 To ensure maximum blocking capability, the age-based ratings should be blocked.

### US custom rating options

If you selected U.S.A. as the country of residence on page 93, the Custom Rating setting includes the following options. (If you selected Canada, see page 95.)

Option	Description
Movie Rating	G All children and general audiences.
	PG Parental guidance suggested.
	PG-13 Parental guidance for children under 13.
	R Restricted viewing, parental guidance is suggested for children under 17.
	NC-17 and X No one 17 and under.
TV Rating <i>Block programs by their rating, content or both</i>	Age-Based Options
	TV-Y All children.
	TV-Y7 Directed to children age 7 and older.
	TV-G General audience.
	TV-PG Parental guidance suggested.
	TV-14 Parents strongly cautioned.
	TV-MA Mature audience only.
	Content-Based Options
	FV Fantasy violence.
	D Suggestive dialog.
	L Strong language.
	S Sexual situations.
	V Violence.
	Unrated <i>Block programs or movies that are broadcast without a rating</i>
Block Blocks all programs and movies that are broadcast without a rating.	

 If you select Block, be aware that the following programs may be blocked: news, sports, weather, emergency broadcasts, political programs, public service announcements, and religious programs.

 **The content ratings will increase depending on the level of the age-based rating. For example, a program with a TV-PG V (Violence) rating may contain moderate violence, while a TV-14 V (Violence) rating may contain more intense violence.**

**Canadian custom rating options**

If you selected Canada as the country of residence on page 93, the Custom Rating setting includes the following options. (If you selected U.S.A., see page 94.)

<i>Option</i>	<i>Description</i>	
English Rating	C	All children.
	C8+	Children 8 years and older.
	G	General programming.
	PG	Parental guidance.
	14+	Viewers 14 and older.
	18+	Adult programming.
French Rating	G	General programming.
	8 ans+	Not recommended for ages under 8.
	13 ans+	Not recommended for ages under 13.
	16 ans+	Not recommended for ages under 16.
	18 ans+	Programming restricted to adults.
U.S.A. Rating	See “TV Rating” on page 94 for details.	





## Accessing the Setup Settings

1. Press MENU.....



2. Highlight.....



3. Press to select.....



To highlight an option and to change settings, press **↑ ↓ ← →**.

Press **ENTER** to confirm the selection.

To exit the Setup settings, press **MENU**.

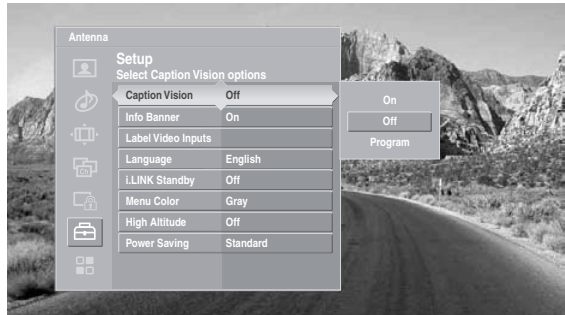

### Selecting Setup Options

The Setup settings include the following options:

Option	Description						
Caption Vision	Allows you to select from four closed caption modes (for programs that are broadcast with closed captioning). <table border="0"> <tr> <td>On</td> <td>Caption Vision is turned on.</td> </tr> <tr> <td>Off</td> <td>Caption Vision is turned off.</td> </tr> <tr> <td>Program</td> <td>Allows you to set basic and advanced Caption Vision options. See “Programming Caption Vision” on page 98.</td> </tr> </table>	On	Caption Vision is turned on.	Off	Caption Vision is turned off.	Program	Allows you to set basic and advanced Caption Vision options. See “Programming Caption Vision” on page 98.
On	Caption Vision is turned on.						
Off	Caption Vision is turned off.						
Program	Allows you to set basic and advanced Caption Vision options. See “Programming Caption Vision” on page 98.						
Info Banner	Set to On or Off. Select On to display the program name, time remaining and other information (if the broadcaster offers this service). Also displays when the channel is changed or the DISPLAY button is pressed.						
Label Video Inputs	Allows you to label the audio/video equipment you have connected to the TV so you can identify them when using the TV/VIDEO button to select inputs. <ol style="list-style-type: none"> <li>Press <b>↑</b> or <b>↓</b> to highlight an input to label, then press <b>ENTER</b> to select it.</li> <li>Use the arrow buttons to scroll through the labels.</li> <li>Press <b>ENTER</b> to select the equipment you connected to each of the input jacks on your TV. Select Skip if you do not have any equipment connected to a particular input.</li> </ol>						

Option	Description	
Label Video Inputs (Continued)	Video 1-3	Video 1-3, VHS, DVD, Receiver, Satellite, Cable Box, 8mm, DTV, Game, LD, Beta, Skip
	Video 4-7	Video 4-7, DVD, Satellite, Cable Box, DTV, HD, Game, PVR, Skip
	Video 8 (PC)	Video 8 (PC), Skip
	 <b>If you select Skip, your TV skips the selected connection when you press TV/VIDEO.</b>	
Language	Select to display all on-screen settings in your language of choice: English, Español, Français.	
i.LINK Standby	On	Allows the i.LINK signal to pass through to connected i.LINK devices even when the TV is turned off. The front panel POWER/STANDBY LED shows red. The TV uses more standby power than when this option is set to Off.
	Off	Does not allow the i.LINK signal to pass through to connected i.LINK devices when the TV is turned off. The TV uses less standby power than when this option is set to On.
Menu Color	Enables you to select a specific color for the on-screen settings: Gray, Red, Green, Indigo and Purple.	
High Altitude	Select On to use the TV at an altitude of 5,000 feet (1,500 m) or higher. Select Off to use the TV at normal altitude.	
Power Saving	Standard	Select to view picture without the benefit of Power Saving.
	Reduced	Select to view picture with reduced power consumption. The picture becomes darker, but also enhances the black level.

 If a CableCARD is inserted, the i.LINK Standby Off setting uses the same amount of power as the i.LINK Standby On setting.

**Programming  
Caption Vision**

If you selected the Program option under Caption Vision (see page 96), you can change the following settings:

<b>Option</b>	<b>Description</b>
Basic	Allows you to select basic analog (EIA-608) closed caption options.
	CC1, CC2, CC3, CC4 Displays a printed version of the dialog or sound effects of a program. (Should be set to CC1 for most programs.)
	Text1, Text2, Text3, Text4 Displays network/station information presented using either half or the whole screen (if available).
Advanced	Allows you to select advanced digital (EIA-708) closed caption options. Select from the available options.
Digital CC	Allows you to set digital closed captioning to Basic (digital EIA-608) or Advanced (digital EIA-708).
Advanced Settings	Allows you to make additional settings for digital (EIA-708) closed caption options. Select from As Broadcast, Small Text, Large Text, and Custom.
	Custom Allows you to customize the following settings:
	Character Size Small, Standard, Large
	Character Style Style 1-7
	Character Color Color 1-8
	Edge Color Color 1-8
	Edge Type None, Raised, Depressed, Outline, Left shadow, Right shadow
	Background Color None, Color 1-8
	Window Color None, Color 1-8

## Selecting PC Setup Options

💡 When there is no signal input, settings for the PC Setup options except Power Management cannot be changed.

To display the PC screen:

- ❑ See “Using the PC Input” on page 60.

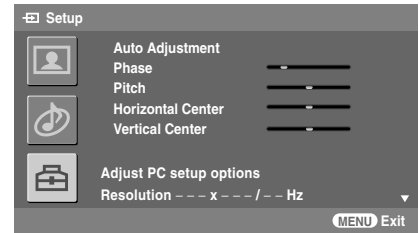

The PC Input Setup setting includes the following options:

Option	Description						
Auto Adjustment	Select to automatically adjust the display position of the picture when the TV receives an input signal from the connected PC. Note that <b>Auto Adjustment</b> may not work well with certain input signals. In such cases, manually adjust the options below.						
Phase	Select to adjust the phase when the screen flickers.						
Pitch	Select to adjust the pitch when the picture has unwanted vertical stripes.						
Horizontal Center	Select to adjust the horizontal position of the picture. Allows you to move the picture left and right in the window. Press ◀ or ▶ and press  to choose a correction between +63 and -64.						
Vertical Center	Select to adjust the vertical position of the picture. Allows you to move the picture up and down in the window. Press ◀ or ▶ and press  to choose a correction between +63 and -64.						
Wide Mode	<table border="1"> <tr> <td>Normal</td> <td>Select to display the picture in its original size.</td> </tr> <tr> <td>Full 1</td> <td>Select to enlarge the picture to fill the display area, keeping its original horizontal-to-vertical ratio.</td> </tr> <tr> <td>Full 2</td> <td>Select to enlarge the picture to fill the display area.</td> </tr> </table> <p> <b>A black frame will appear on the surrounding of the picture.</b></p> <p> <b>When using SXGA signals and Wide Mode is set to Normal, the top and bottom of the picture will be cropped. When it is set to either Full 1 or Full 2 with SXGA signals, the picture will appear in reduced size.</b></p>	Normal	Select to display the picture in its original size.	Full 1	Select to enlarge the picture to fill the display area, keeping its original horizontal-to-vertical ratio.	Full 2	Select to enlarge the picture to fill the display area.
Normal	Select to display the picture in its original size.						
Full 1	Select to enlarge the picture to fill the display area, keeping its original horizontal-to-vertical ratio.						
Full 2	Select to enlarge the picture to fill the display area.						
Power Management	<table border="1"> <tr> <td>On</td> <td>Select to automatically switch to the power saving mode when there is no signal input for 10 minutes.</td> </tr> <tr> <td colspan="2"> <b>POWER/STANDBY LED will light up in red when your TV is in the power saving mode.</b></td> </tr> <tr> <td>Off</td> <td>Select to turn off Power Management.</td> </tr> </table>	On	Select to automatically switch to the power saving mode when there is no signal input for 10 minutes.	<b>POWER/STANDBY LED will light up in red when your TV is in the power saving mode.</b>		Off	Select to turn off Power Management.
On	Select to automatically switch to the power saving mode when there is no signal input for 10 minutes.						
<b>POWER/STANDBY LED will light up in red when your TV is in the power saving mode.</b>							
Off	Select to turn off Power Management.						
Reset	Select to restore the factory default settings.						

💡 A warning message will appear before switching to the power saving mode.

(Continued)

## Using the Settings

### PC Input Signal Compatibility Chart

Resolution			Horizontal frequency (kHz)	Vertical frequency (Hz)	VESA standard
Signal	Horizontal (Pixel)	Vertical (Line)			
VGA	640	400	31.5	70	—*
	720	400	31.5	70	—*
	640	480	31.5	60	—*
	640	480	37.9	72	✓
	640	480	37.5	75	✓
	640	480	43.3	85	✓
SVGA	800	600	35.1	56	✓
	800	600	37.9	60	✓
	800	600	48.1	72	✓
	800	600	46.9	75	✓
	800	600	53.7	85	✓
XGA	1024	768	48.4	60	✓
	1024	768	56.5	70	✓
	1024	768	60	75	✓
	1024	768	68.7	85	✓
WXGA	1280	768	47.8	60	✓
SXGA	1280	1024	64	60	✓

\*: Corresponding to the VGA signal

 **This TV does not support Sync on Green or Composite Sync.**

 **If a signal other than in the above chart is input, it may not be displayed properly or may not be displayed as you set. Normal display mode is not available when the signal other than 60 is used for Vertical frequency.**

 **For best results, use a Vertical frequency of 60 for your PC.**

 **If unsupported signals are used, you will see the message, “Unsupported Signal”.**



## Accessing the Applications Settings

1. Press MENU.....



2. Highlight.....



3. Press to select .....



To highlight an option and to change settings, press  $\uparrow$   $\downarrow$   $\leftarrow$   $\rightarrow$ .

Press  $\text{ENTER}$  to confirm the selection.

To exit the Applications settings, press  $\text{MENU}$ .

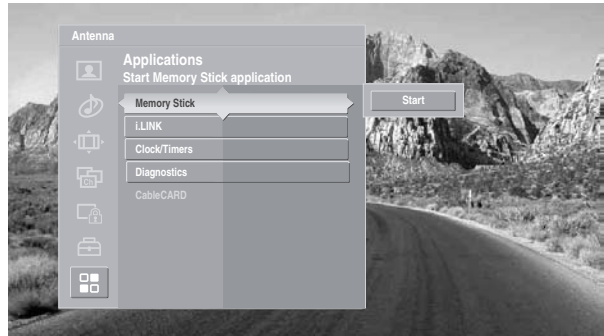

### Selecting Applications Options

You can also use the MEMORY STICK and i.LINK buttons on the remote control.

The Applications settings include the following options:





Option	Description
Memory Stick	Start Displays the Memory Stick Viewer. For details, see page 61.
i.LINK	Start Displays the i.LINK Device List. For details, see page 75.
Clock/Timers	Select to set the clock and to program your TV to turn on and off at two scheduled viewing times.
Sleep	Allows you to select the amount of time (Off, 15 minutes, 30 minutes, 45 minutes, 60 minutes or 90 minutes) that you want the TV to remain on before shutting off automatically.
Timer 1	You can use the Timers to program the TV to turn on and off and tune to a specific channel at two scheduled viewing times.
Timer 2	

Timer 1 and Timer 2 cannot be set until you set the Current Time.

**1** Press  $\uparrow$  or  $\downarrow$  to highlight Timer 1 or Timer 2. To set the timer, press  $\rightarrow$ .

**To go directly to programming Timer 1 or 2, press  $\text{ENTER}$  instead of pressing  $\rightarrow$ .**

(Continued)

<b>Option</b>	<b>Description</b>
Clock/Timers (Continued)	<p><b>2</b> Press <b>▲</b> or <b>▼</b> to highlight one of the following options, then press .</p> <p><b>Program</b> Select to set the Timer by day, time, duration, and channel.</p> <p><b>Off</b> Select to turn off the Timer. (Your previous settings are saved.)</p> <p><b>3</b> If you selected <b>Program</b> in step 2, press <b>▲</b> and <b>▼</b> to set the day(s), hour, minute, AM/PM, duration, and channel number. Press  or press <b>▶</b> to confirm each setting and move to the next setting. Press <b>◀</b> to go back to the previous setting.</p> <p><b>4</b> Press <b>MENU</b> to exit the setting screen. An LED on the front panel will light, indicating the Timer has been set.</p>
Current Time	You can set the current time.
	<p><b>1</b> Press  to select Current Time.</p> <p><b>2</b> Press <b>▲</b> and <b>▼</b> to set the current time (day, hour, minute, and AM/PM). Press  (or press <b>▶</b>) to confirm each setting and move to the next setting. Press <b>◀</b> to go back the previous setting.</p> <p><b>3</b> Press <b>MENU</b> to exit the setting screen.</p>
Diagnostics	Display diagnostics information about the TV. This can be useful in providing information to an authorized technician or repair person.
CableCARD	This list of selectable CableCARD options will vary, depending on your cable service provider.

# Other Information

## Overview

This chapter includes the following topics:

<i>Topic</i>	<i>Page</i>
Contacting Sony	<b>103</b>
Replacing the Lamp	<b>104</b>
Troubleshooting	<b>108</b>
Specifications	<b>115</b>
Optional accessories:	<b>116</b>
Index	<b>117</b>

## Contacting Sony

If, after reading these operating instructions, you have additional questions related to the use of your Sony television, please call our Customer Information Services Center.

For US residents:	1-800-222-SONY (7669) or visit <a href="http://www.sonystyle.com/tv/">http://www.sonystyle.com/tv/</a>
For Canadian residents:	1-877-899-SONY (7669) or visit <a href="http://www.sonystyle.ca/tv/">http://www.sonystyle.ca/tv/</a>

Before calling Sony customer support, please write down the model and serial numbers of your TV. You'll find this information on the front cover of this manual.



## Replacing the Lamp

The projection lamp, which illuminates the picture, has a limited life.

If the screen becomes dark, the color looks unusual, or the LAMP indicator on the front of the TV flashes, this indicates the lamp needs to be replaced with a new one (not supplied).



### **WARNING**

**Electric appliances can cause fire or high temperature, resulting in injury or death. Be sure to follow the instructions below.**

- Use a Sony XL-5100 replacement lamp (not supplied) for replacement. Use of any other lamp may damage the TV.
- Do not remove the lamp for any purpose other than replacement. Doing so may cause injury or fire.
- Do not put flammable materials and metal objects inside the lamp receptacle of the TV after removing the lamp. Doing so may cause fire or electrical shock. Do not touch the lamp receptacle once the lamp has been removed.
- When the lamp eventually burns out, you may hear a noticeable “pop” sound. This is normal and it is inherent to this type of lamp.
- In rare instances, the bulb may pop inside the lamp unit, but the lamp unit is designed to contain all of the broken glass pieces inside the lamp unit.
- The lamps contain mercury. For proper disposal of the used lamps, follow and observe the local ordinances. See page 107.

## How to Replace the Lamp

- 1** Turn off the power on the main unit. Wait several minutes, then unplug the power cord.  
(The cooling fan will continue to operate for about two minutes after turning the power off.)
- 2** Wait at least 30 minutes after unplugging the power cord to allow the lamp to cool down before replacing it. To avoid being burned, do not touch the lamp receptacle once the lamp has been removed.
- 3** Take the new lamp out of its package.  
Do not touch the glass portion of the new lamp.

 **Do not shake the lamp. Vibration can damage the lamp or shorten its life.**

 **Avoid touching the front glass of a new lamp or the glass of the lamp receptacle. This may reduce picture quality or lamp life.**

- 4** Turn the screw with a screwdriver counterclockwise and remove the outside lamp cover.

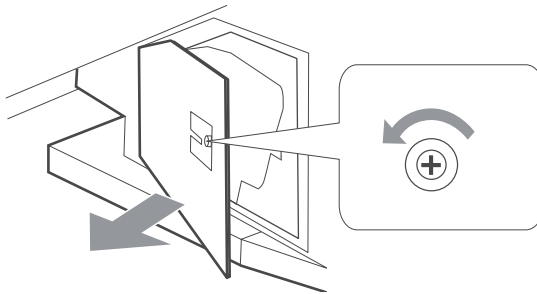

- 5** Pull out the lamp.  
Place your index finger through the hoop of the lamp handle and pull upwards, while placing your thumb on the dent on the top. Then pull the lamp out.

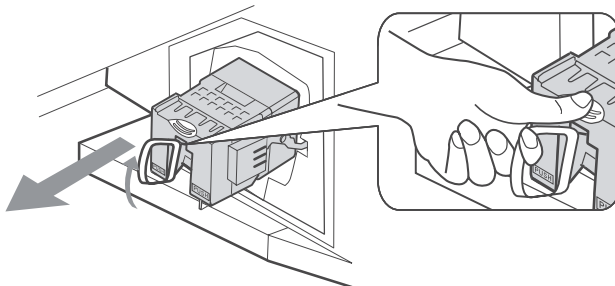

 **The lamp is very hot after use. Never touch the glass portion of the lamp or the non-designated surrounding parts (shown in gray).**

 **After the used lamp has cooled, place it into the empty box of the replacement lamp. Never put the used lamp into a plastic bag.**

(Continued)

- 6** Place the lamp halfway in. Follow the gutter in the compartment to mount the new lamp securely.

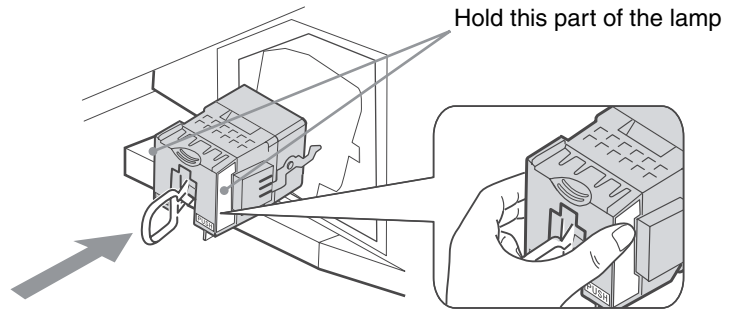

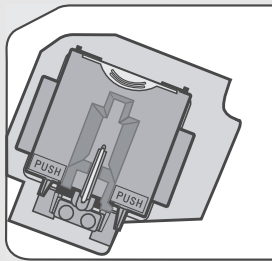

-  The lamp compartment is tilted, as shown in the following illustration.



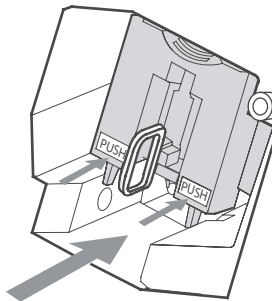

- 7** Slide it in slowly by pressing the **PUSH** part of the front corners of the lamp until it stops with a firm clicking sound to lock.

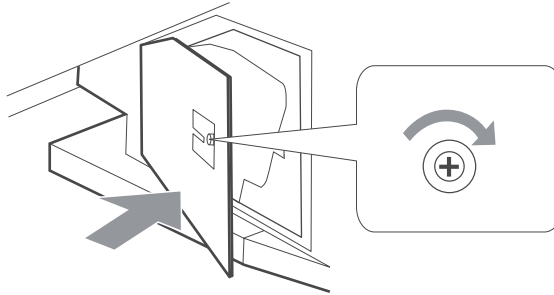

-  To ensure the lamp is securely installed, press the area marked **PUSH** before closing the lamp cover.
-  If the lamp is not securely reattached, the self-diagnostic function may be triggered and the POWER/STANDBY indicator flashes in red three times (see page 12).

- 8** Place the outside lamp cover back in its place. Turn the screw with a screwdriver clockwise and secure the cover.



-  **Consult your Sony dealer for a Sony XL-5100 replacement lamp.**
-  **Take great care when replacing the lamp or plugging in/unplugging the connecting cords. Rough handling may cause the TV to fall, damaging the TV, the TV stand and the floor.**

#### The used lamp

This product contains mercury. Disposal of this product may be regulated if sold in the United States. For disposal or recycling information, please contact your local authorities or the Electronics Industries Alliance (<http://www.eiae.org>).

- Do not leave the used lamp near flammable materials or within the reach of children.
- Do not pour water onto the used lamp or put any object inside the lamp. Doing so may cause the lamp to burst.

**For replacement lamp information visit:**  
 U. S. residents: <http://www.sonystyle.com/tv/>  
 Canadian residents: <http://www.sonystyle.ca/tv/>

## Troubleshooting

### Twin View

<b>Problem</b>	<b>Possible Remedies</b>
I cannot get Twin View to work.	<ul style="list-style-type: none"><li><input type="checkbox"/> If you are using a cable box to unscramble all channels (as shown on page 25), you cannot use the Twin View feature. This is because the cable box can unscramble only one channel at a time.</li><li><input type="checkbox"/> You can use Twin View to view a signal from a different source that is connected to the TV's A/V jacks (such as a VCR or DVD player) in the second window by pressing TV/VIDEO while in Twin View.</li><li><input type="checkbox"/> Sources connected to the VIDEO 4, VIDEO 5, VIDEO 6 and VIDEO 7 inputs, as well as digital sources display only in the left Twin View window.</li><li><input type="checkbox"/> Twin View is not available when using VIDEO 8 (PC) IN or i.LINK input.</li></ul>
There is no Twin View window, or it is just static.	<ul style="list-style-type: none"><li><input type="checkbox"/> Be sure the Twin View window is set to a video input or channel that has a signal airing.</li><li><input type="checkbox"/> You might be tuned to a video input with nothing connected to it. Try cycling through the video inputs by pressing TV/VIDEO.</li></ul>
Twin View cannot display anything but TV channels.	<ul style="list-style-type: none"><li><input type="checkbox"/> Try cycling through the video inputs by pressing TV/VIDEO. Check that the Label Video Inputs option is not set to Skip. (See the Setup setting on page 96.)</li></ul>
Twin View displays the same program in both windows.	<ul style="list-style-type: none"><li><input type="checkbox"/> Both Twin View windows might be set to the same channel. Try changing channels in either window.</li></ul>

### Remote Control

<b>Problem</b>	<b>Possible Remedies</b>
Remote control does not operate.	<ul style="list-style-type: none"><li><input type="checkbox"/> The batteries could be weak. Replace the batteries.</li><li><input type="checkbox"/> Check the orientation of the batteries.</li><li><input type="checkbox"/> Press FUNCTION repeatedly until the TV indicator lights up. You may have inadvertently pressed FUNCTION, which changes the remote control to SAT or CABLE mode.</li><li><input type="checkbox"/> Make sure this unit's power cord is connected securely to the wall outlet.</li><li><input type="checkbox"/> Locate the unit at least 3-4 feet away from fluorescent lights.</li><li><input type="checkbox"/> If the "High Temperature Warning!" message appears, turn off the TV and wait until the TV's projection lamp cools down (approximately 5 minutes). If the remote control still does not work, make sure to dust the ventilation slots on the rear of the TV and the cooling fan to provide adequate ventilation around the TV.</li></ul>
Cannot change channels with the remote control.	<ul style="list-style-type: none"><li><input type="checkbox"/> If you are using the TV to change channels, first press FUNCTION repeatedly until the TV indicator lights up.</li><li><input type="checkbox"/> If you are using another device to change channels, be sure you have not inadvertently switched your TV from the channel 3 or 4 setting. Use the Channel Fix option to "Fix" the channel based on the hookup you used (see page 90).</li><li><input type="checkbox"/> If you are using another device to change channels, be sure to press FUNCTION for that device. For example, if you are using your cable box to change channels, be sure to press FUNCTION repeatedly until the SAT/CABLE indicator lights up.</li></ul>

<b>Problem</b>	<b>Possible Remedies</b>
Remote control does not operate non-Sony video equipment.	<ul style="list-style-type: none"> <li><input type="checkbox"/> If you replaced the batteries to the remote recently, the code numbers for the video equipment may need to be reset.</li> <li><input type="checkbox"/> There may be more than one code for the equipment that you are attempting to operate.</li> <li><input type="checkbox"/> There is a possibility that some non-Sony equipment cannot be operated by your Sony TV remote. You may need to use the equipment's original remote control.</li> </ul>

## CableCARD Device





<b>Problem</b>	<b>Possible Remedies</b>
Problems using CableCARD device or CableCARD services.	<ul style="list-style-type: none"> <li><input type="checkbox"/> Check that the CableCARD is inserted properly (see page 32).</li> <li><input type="checkbox"/> The CableCARD device must be activated by your local cable TV provider before you can receive digital cable TV services. See the activation instructions on page 32.</li> <li><input type="checkbox"/> Check the <b>Diagnostics</b> and <b>CableCARD</b> setting options (see page 102). (This can be useful in providing information to an authorized technician or repair person.)</li> <li><input type="checkbox"/> Contact your cable TV provider.</li> <li><input type="checkbox"/> If you have moved, ask the CableCARD provider in your new location for a new CableCARD.</li> </ul>

## Memory Stick

<b>Problem</b>	<b>Possible Remedies</b>
Image does not display/Cannot see all files.	<ul style="list-style-type: none"> <li><input type="checkbox"/> Some variations of MPEG1 movies may not play back correctly.</li> <li><input type="checkbox"/> Make sure the image file is a JPEG (.jpg, .jpeg) file or an MPEG1 (.mpg, .mpeg) file.</li> <li><input type="checkbox"/> Make sure the Memory Stick is inserted properly (see page 63).</li> <li><input type="checkbox"/> Check the <b>Filter</b> option setting (see page 69).</li> <li><input type="checkbox"/> Check the <b>Select Folder</b> setting (see page 69) and ensure that files are either in DCF directories if <b>Digital Camera Folders</b> is selected (see page 69), or in the currently selected folder if <b>Select a Folder</b> is selected (see page 69).</li> <li><input type="checkbox"/> The maximum number of files the Memory Stick Viewer can display is 2,000 files total, including all JPEG, MPEG1, and MP3 files.</li> </ul>
JPEG image displays undesirable motion or flicker in full screen.	<ul style="list-style-type: none"> <li><input type="checkbox"/> JPEGs captured using a digital video camera may appear to display motion in full screen. This is a result of the way digital video cameras record still images, and is not a result of a malfunction with the TV.</li> </ul>
Rotation not saved after Memory Stick is ejected or Memory Stick Viewer is closed.	<ul style="list-style-type: none"> <li><input type="checkbox"/> The Memory Stick might be locked. Unlock the Memory Stick and try rotating the image again.</li> <li><input type="checkbox"/> The file might not have information (EXIF data) that is usually generated when a digital camera records a photo. In this case, it is not possible to save the rotation.</li> <li><input type="checkbox"/> There might be insufficient space on the Memory Stick to save the rotated file. Try deleting one or more files and rotating the image again.</li> </ul>
Cannot show (or hide) file information in full screen or Slide Show.	<ul style="list-style-type: none"> <li><input type="checkbox"/> Set the <b>File Information</b> option to <b>On</b> or <b>Off</b> (see page 68).</li> </ul>
Cannot see menu.	<ul style="list-style-type: none"> <li><input type="checkbox"/> Press <b>▲</b> to display the menu again.</li> </ul>

(Continued)

## Other Information

<b>Problem</b>	<b>Possible Remedies</b>	
Cannot hear audio while using Memory Stick.	<input type="checkbox"/>	Check the TV's volume or <b>Speaker</b> (see page 87) settings.
	<input type="checkbox"/>	To hear JPEG voice memo, select the <b>Digital Camera Folders</b> option and set the <b>Filter</b> option to <b>Show All Print Marks</b> .
	<input type="checkbox"/>	Check that the <b>Music</b> option is not set to <b>Off</b> (see page 68).
Not all MP3 files on Memory Stick are included when the <b>Music/Complete List</b> option is selected (page 68).	<input type="checkbox"/>	The Memory Stick Viewer can display a maximum of 2,000 files total, including all JPEG, MPEG1, and MP3 files.
	<input type="checkbox"/>	Make sure that the file is named with the file extension (.mp3).
MP3 files on the Memory Stick are not listed.	<input type="checkbox"/>	Only MP3 files that are named with the file extension (.mp3) are displayed in the list.
Music files are playing in wrong order.	<input type="checkbox"/>	MP3 files are played in alphabetical order, according to the folder in which they are stored. If you want to change the playlist order, rename your files alphabetically in the order in which you want them to play or create a MP3 playlist (.m3u file) on a PC.
Cannot see MP3 list to play music.	<input type="checkbox"/>	MP3 files on your Memory Stick only can be played as background music during a Slide Show (see page 68).
MPEG1 movie does not play back correctly.	<input type="checkbox"/>	Some variations of MPEG1 movies may not be compatible with the Memory Stick Viewer.
	<input type="checkbox"/>	MPEG movies recorded in VX Fine mode with Sony digital cameras cannot be played back with the Memory Stick Viewer.
MPEG1 quality is poor when enlarged (page 66).	<input type="checkbox"/>	The quality of the movie when enlarged depends on the resolution of the MPEG1 file. See your camera's instruction manual for details.
Error message is displayed.	<input type="checkbox"/>	No Memory Stick      There is no Memory Stick in the slot.
	<input type="checkbox"/>	Memory Stick is locked      The lock mechanism on the Memory Stick is engaged.
	<input type="checkbox"/>	Memory Stick error      The Memory Stick in the slot might be damaged; try a different Memory Stick.
	<input type="checkbox"/>	Format Error      The Memory Stick may have been formatted using a PC or other device that is not compatible with cameras.
Error icon is displayed.		The file is not a valid MPEG1 or JPEG format, or it is a progressive JPEG (which is not supported).
		The thumbnail is not DCF-compatible.
		The file is a JPEG or an MPEG1, but the thumbnail is unreadable.
		The file is unreadable.

## Video

<b>Problem</b>	<b>Possible Remedies</b>
No picture (screen not lit), no sound.	<ul style="list-style-type: none"> <li><input type="checkbox"/> If your TV does not turn on, and a red light keeps flashing, your TV may need service. Call your local Sony Service Center.</li> <li><input type="checkbox"/> Make sure the power cord is plugged in.</li> <li><input type="checkbox"/> Press <b>POWER</b> on the front of the TV.</li> <li><input type="checkbox"/> Press <b>TV/VIDEO</b> to cycle through the connected video sources.</li> <li><input type="checkbox"/> Try another channel; it could be station trouble.</li> </ul>
Dark, poor or no picture (screen lit), good sound.	<ul style="list-style-type: none"> <li><input type="checkbox"/> Adjust the <b>Picture Mode</b> option in the Video setting (see page 81).</li> <li><input type="checkbox"/> Adjust the <b>Brightness</b> option in the Video setting (see page 81).</li> <li><input type="checkbox"/> Check the antenna/cable connections.</li> </ul>
No color/dark picture/color is not correct.	<ul style="list-style-type: none"> <li><input type="checkbox"/> Adjust the <b>Color</b> option in the Video setting (see page 81).</li> </ul>
Only snow and noise appear on the screen.	<ul style="list-style-type: none"> <li><input type="checkbox"/> Check the antenna/cable connections.</li> <li><input type="checkbox"/> Try another channel; it could be station trouble.</li> <li><input type="checkbox"/> Press <b>ANT</b> to change the input mode (see page 46).</li> </ul>
Dotted lines or stripes.	<ul style="list-style-type: none"> <li><input type="checkbox"/> Adjust the antenna.</li> <li><input type="checkbox"/> Move the TV away from noise sources such as cars, neon signs, or hair dryers.</li> </ul>
Double images.	<ul style="list-style-type: none"> <li><input type="checkbox"/> Using a highly directional outdoor antenna or a cable may solve the problem.</li> </ul>
“Black box” on screen.	<ul style="list-style-type: none"> <li><input type="checkbox"/> You have selected a text option in the Setup setting and no text is available. (see page 96 to reset Setup selections.) To turn off this feature, set the <b>Caption Vision</b> option to <b>Off</b>. If you were trying to select closed captioning, select <b>CC1</b> instead of <b>Text 1-4</b>.</li> </ul>
Black bands appear at the top and bottom of the screen.	<ul style="list-style-type: none"> <li><input type="checkbox"/> Some wide-screen programs are filmed in aspect ratios that are greater than 16:9 (this is especially common with theatrical releases). Your TV will show these programs with black bands at the top and bottom of the screen. For more details, check the documentation that came with your DVD (or contact your program provider).</li> </ul>
Certain programs on DVD or other digital sources display a loss of detail, especially during fast-motion or dark scenes.	<ul style="list-style-type: none"> <li><input type="checkbox"/> The compression used by certain digital broadcasts and DVDs may cause your TV’s screen to display less detail than usual, or cause artifacts (small blocks or dots, pixelations) to appear on your screen. This is due to your TV’s large screen and ability to show very fine detail, and is normal for certain digitally recorded programs. Adjust the reality/clarity in the <b>DRC Palette</b> setting (see page 83) to optimize the picture while viewing these sources.</li> </ul>

## Audio

<b>Problem</b>	<b>Possible Remedies</b>
Good picture, no sound.	<ul style="list-style-type: none"> <li><input type="checkbox"/> Press <b>MUTING</b> so that “Muting” disappears from the screen (see page 46).</li> <li><input type="checkbox"/> Make sure the <b>Speaker</b> option is set to <b>On</b> in the Audio setting (see page 87).</li> <li><input type="checkbox"/> Make sure the <b>MTS</b> option is set to <b>Stereo</b> or <b>Mono</b> (see page 87).</li> <li><input type="checkbox"/> When the <b>HDMI IN</b> input is in use, surround sound, such as <b>AC-3</b> and <b>DTS</b>, cannot be input. Change the sound setting for the external input device to <b>Linear PCM</b>.</li> </ul>

(Continued)



## Other Information

<b>Problem</b>	<b>Possible Remedies</b>
Audio noise.	<input type="checkbox"/> Communication problems may occur if infrared communication equipment (e.g., infrared cordless headphones) is used near the TV. Please use headphones other than cordless headphones. Also, if you use infrared communication equipment other than infrared cordless headphones, move the infrared transceiver away from the TV until the noise is eliminated, or move the transmitter and receiver of the infrared communication equipment closer together.
Cannot gain enough volume when using a cable box.	<input type="checkbox"/> Increase the volume of the cable box using the cable box's remote control. Then press <b>FUNCTION</b> repeatedly until the TV indicator lights up and adjust the TV's volume.
Sound seems weak or insufficient.	<input type="checkbox"/> The TV's audio might be set to <b>Auto SAP</b> or <b>Mono</b> , when it might be better set to <b>Stereo</b> . In the Audio setting (see page 87), set the <b>MTS</b> setting to <b>Stereo</b> . If already set to <b>Stereo</b> , switch to <b>Mono</b> (which may reduce background noise during weak stereo broadcasts).
Cannot raise the volume on external speakers.	<input type="checkbox"/> If the <b>Speaker</b> option is set to <b>Off</b> and the <b>Audio Out</b> option is set to <b>Fixed</b> (in order to output the sound to your audio system), use your audio receiver to adjust the sound (see page 87). Or, to use the TV remote control, set the <b>Audio Out</b> option to <b>Variable</b> . <input type="checkbox"/> To turn on the TV speakers, set the <b>Speaker</b> option to <b>On</b> (see page 87).

## Channels

<b>Problem</b>	<b>Possible Remedies</b>
Cannot receive upper channels (UHF) when using an antenna.	<input type="checkbox"/> Press <b>ANT</b> to select the VHF/UHF input (see page 46). <input type="checkbox"/> Use <b>Auto Program</b> in the Channel setting to add receivable channels that are not presently in the TV's memory (see page 90).
TV is fixed to one channel.	<input type="checkbox"/> Use <b>Auto Program</b> in the Channel setting to add receivable channels that are not presently in the TV's memory (see page 90). <input type="checkbox"/> Check your <b>Channel Fix</b> settings (see page 90).
Cannot receive any channels when using cable TV.	<input type="checkbox"/> Use <b>Auto Program</b> in the Channel setting to add receivable channels that are not presently in the TV's memory (see page 90). <input type="checkbox"/> Press <b>ANT</b> to select the <b>CABLE</b> input (see page 46).
Cannot receive or select channels.	<input type="checkbox"/> Use <b>Auto Program</b> in the Channel setting to add receivable channels that are not presently in the TV memory (see page 90).
Some digital cable channels are not being displayed.	<input type="checkbox"/> Certain cable companies have limitations on the broadcast of digital cable channels. Check with your cable company for more information. <input type="checkbox"/> The digital cable channel may be set to <b>Hidden</b> in the Channel setting (see page 91).

## General



<b>Problem</b>	<b>Possible Remedies</b>
How to reset TV to factory settings.	<ul style="list-style-type: none"> <li><input type="checkbox"/> Turn on the TV. While holding down the <b>▲</b> button on the remote control, press the <b>POWER</b> button on the TV. (The TV will turn itself off, then back on again.) Release the <b>▲</b> button.</li> <li><b>WARNING:</b> The reset will clear all of your customized settings including <b>Parental Lock</b> setting.</li> </ul>
How to restore Video settings to factory settings.	<ul style="list-style-type: none"> <li><input type="checkbox"/> Press <b>RESET</b> on the remote control while in the Video setting (see page 81).</li> <li><input type="checkbox"/> The supplied method will not work for <b>Advanced Video</b> settings.</li> </ul>
How to restore Audio settings to factory settings.	<ul style="list-style-type: none"> <li><input type="checkbox"/> Press <b>RESET</b> on the remote control while in the Audio setting (see page 86).</li> </ul>
Cannot cycle through the other video equipment connected to the TV.	<ul style="list-style-type: none"> <li><input type="checkbox"/> Be sure the <b>Label Video Inputs</b> option is not set to <b>Skip</b> (see page 96).</li> </ul>
Cannot operate the settings.	<ul style="list-style-type: none"> <li><input type="checkbox"/> If a setting option appears in gray, this indicates that the setting option is not available.</li> </ul>
Lost password.	<ul style="list-style-type: none"> <li><input type="checkbox"/> In the password screen (see page 80), enter the following master password: <b>4357</b>. The master password clears your previous password; it cannot be used to temporarily unblock channels.</li> </ul>
TIMER LED on front panel is lit.	<ul style="list-style-type: none"> <li><input type="checkbox"/> The LED (see page 16) blinks when the TV is turned on, then shuts off when the picture is displayed. If the red LED blinks continuously, this may indicate the TV needs service. When lit, indicates that the timer is set (see page 16). When the timer is set, this LED will remain lit even when the TV is turned off.</li> </ul>
POWER/STANDBY LED blinks in red.	<ul style="list-style-type: none"> <li><input type="checkbox"/> If the LED blinks three times, the lamp cover may not be attached securely (see page 106). The LED blinks two times if there is an abnormal rise in temperature inside the TV when any ventilation openings are blocked.</li> <li><input type="checkbox"/> The signal from an i.LINK device is being shown.</li> </ul>
LAMP LED blinks in red.	<ul style="list-style-type: none"> <li><input type="checkbox"/> Replace the lamp (see page 104).</li> </ul>
The replacement lamp does not light up.	<ul style="list-style-type: none"> <li><input type="checkbox"/> The screw of the lamp cover may be slanted. Take out the screw, insert it straight into the screw hole, and then tighten it completely (see page 104).</li> </ul>
Digital cable box does not work.	<ul style="list-style-type: none"> <li><input type="checkbox"/> If you are connecting a VCR and digital cable box using a splitter, as described on page 37, you must use a special bi-directional splitter that is designed to work with your digital cable box. Contact your cable provider for details.</li> </ul>
Cannot record digital channels to VCR.	<ul style="list-style-type: none"> <li><input type="checkbox"/> Only analog channels can be recorded to your VCR.</li> </ul>
TV cabinet creaks.	<ul style="list-style-type: none"> <li><input type="checkbox"/> When the TV is in use, there is a natural rise in temperature, causing the cabinet to expand or contract and may be accompanied by a slight creaking noise. This is not a malfunction.</li> </ul>
A slight creaking noise occurs from the bottom part of the TV.	<ul style="list-style-type: none"> <li><input type="checkbox"/> <b>Advanced Iris</b> applies a mechanical iris system. When <b>Advanced Iris</b> is turned <b>On/Off</b>, a natural creaking noise occurs due to the basic structure of the optical unit. The creaking sound is an inherent nature of this system and is not a defect.</li> </ul>
The cooling fan is loud.	<ul style="list-style-type: none"> <li><input type="checkbox"/> If the TV is used at high altitudes and <b>High Altitude</b> is set to <b>On</b>, the cooling fan runs faster and its sound becomes louder. If the TV is not used at high altitudes, set <b>High Altitude</b> to <b>Off</b> (see page 97).</li> </ul>

(Continued)

## Other Information

<i>Problem</i>	<i>Possible Remedies</i>
"High Temperature Warning!" message appears.	<ul style="list-style-type: none"><li>❑ This message will appear when there is a rise in temperature inside the TV. Make sure to remove dust from the ventilation slots on the rear and both sides of the TV. In addition, make sure that there are no obstacles in front of the ventilation slots. If no blockage is found, you may need to set <b>High Altitude</b> mode to <b>On</b>, otherwise the TV will turn off. With <b>High Altitude</b> set to <b>On</b>, if the message reappears and TV turns off again, the TV may need servicing. Call your local Sony Service Center.</li></ul>
The signal from a selected i.LINK device is not being displayed.	<ul style="list-style-type: none"><li>❑ If you have several i.LINK devices connected and operating at once, the TV may not be able to display the signal from the selected device. Turn the other i.LINK devices off, and reselect the desired i.LINK device.</li><li>❑ If you are using a digital VCR, turn off any Auto LINC functionality of the VCR. For details, see the digital VCR's user manual.</li></ul>
The TV does not turn on.	<ul style="list-style-type: none"><li>❑ The TV cools down its projection lamp when the power is turned off. It takes up to two minutes for the picture to come back after the TV is turned on again. Wait for a while until the picture comes back.</li></ul>

## Specifications

Projection System	3 SXRD Panel, 1 lens projection system	
SXRD Panel	0.61 inch SXRD panel 6,220,800 pixels (2,073,600 × 3)	
Projection Lens	High Performance, large diameter hybrid lens F2.5	
Antenna	75 ohm external terminal for VHF/UHF	
Lamp	UHP lamp, 120W, XL-5100	
Television System	NTSC	American TV Standard
	ATSC (8VSB terrestrial)	ATSC compliant 8VSB
	QAM on cable	ANSI/SCTE 07 2000
Visible Screen Size (picture measured diagonally)	KDS-R50XBR1: 50 inches	
	KDS-R60XBR1: 60 inches	
Channel Coverage	Terrestrial (analog)	2-69
	Cable TV (analog)	1-125
	Terrestrial (digital)	2-69
	Cable TV (digital)	1-135
Power Requirements	120V, 60 Hz	
Inputs/Outputs		
HDMI IN	2 total	Video: 1080i, 720p, 480p, 480i Audio: Two channel linear PCM 32, 44.1 and 48 kHz, 16, 20 and 24 bit  <b>Not compatible with compressed sound, such as AC-3 and DTS.</b>
Video (IN)	3 total (1 on front panel)	1 Vp-p, 75 ohms unbalanced, sync negative
S Video (IN)	3 total (1 on front panel)	Y: 1 Vp-p, 75 ohms unbalanced, sync negative C: 0.286 Vp-p (Burst signal), 75 ohms
Audio (IN)	6 total (1 on front panel)	500 mVrms (100% modulation) Impedance: 47 kilohms
Component Video Input	2 (YPbPr)	Y: 1 Vp-p, 75 ohms unbalanced, sync negative Pb: 0.7 Vp-p, 75 ohms Pr: 0.7 Vp-p, 75 ohms
CONTROL S (IN)	1	Mini jack
CONTROL S (OUT)	1	Mini jack
AUDIO OUT (VAR/FIX)	1	500 mVrms at the maximum volume setting (Variable) 500 mVrms (Fixed) Impedance (output): 2 kilohms  <b>AUDIO OUT jacks are operable only when the TV's Speaker is set to Off. For details, see page 87.</b>

(Continued)

## Other Information

PC IN	D-sub 15-pin, analog RGB, 0.7 Vp-p, 75 ohms, positive
	 <b>See the PC Input Signal Compatibility Chart on page 100.</b>
i.LINK	3 total (1 on front panel)      4-pin S400 i.LINK terminal
RF Inputs	2
Digital Audio Optical Output (PCM/Dolby Digital)	1      Optical Rectangular (1)
CableCARD Slot	PCMCIA Type I/II
Speaker Output	15 W (L), 15 W (R)
Dimensions (W × H × D)	KDS-R50XBR1 1,453 × 863 × 478 mm (57 1/4 × 34 × 18 7/8 inches) KDS-R60XBR1 1,674 × 1,009 × 514 mm (66 × 39 3/4 × 20 1/4 inches)
Mass	KDS-R50XBR1 43kg (94 lb. 13 oz.) KDS-R60XBR1 51kg (112 lb. 7 oz.)
Power Consumption	
In Use	240 W
In Standby	0.5 W
In i.LINK/CableCARD Standby	Less than 30 W
Supplied Accessories	
Remote Control	RM-Y914
AA (R6) Batteries	2 supplied for remote control
Operating Instructions	1
Quick Setup Guide	1
Warranty	1
Product Registration Card	1

Design and specifications are subject to change without notice.

### Optional accessories:

- HDMI cable
- HDMI-to-DVI cable
- Component video cable
- S VIDEO cable
- A/V cable
- Audio cable
- Optical cable
- Control S cable : RK-G69
- TV Stand : SU-GW12
- Theatre Stand System : RHT-G2000
- Lamp : XL-5100
- i.LINK cables: VMC-IL4415 (4-pin to 4-pin, 1.5 meters); VMC-IL4435 (4-pin to 4-pin, 3.5 meters)

 **The availability of optional accessories depends on stock.**

Design and specifications are subject to change without notice.

Non-metric weights and measures are approximate.

# Index

0 – 9 buttons 47

4:3 Default 89

## A

About Using the CableCARD Device 32

Adding channels to the channel list 91

Adjusting audio, Steady Sound 86

Advanced Iris 83

Alternate Audio 52

Alternate Video 52

ANT button 46

Applications settings 80, 101

AUDIO OUT 19

Audio Out 87

AUDIO OUT jack, described 19

Audio receiver, connecting 43

Audio settings 79, 86

Auto Program 90

## B

Balance, adjusting 86

Bass, adjusting 86

Batteries, inserting in remote 45

Black Corrector 84

BN Smoother 83

Brightness, adjusting 81, 85

## C

CABLE 18

Cable

connecting with VCR 36

Cable box

connecting with VCR 37

using with remote control 50

CableCARD

device 32, 102

slot 18

Camcorder connection 42

Canadian Rating 95

Caption Vision 96

programming 98

CH +/- button 47

Change Password 93

CHANNEL +/- button 16

Channel Fix 90

Channel settings 80, 90

Channel Show/Hide 91

Channels

Auto Program 90

creating labels 91

Clear White 84

Clock/Timers 101

Closed caption modes 96

Color Corrector 84

Color Temp., adjusting 82, 85

Color, adjusting 81

Connecting

Audio receiver 43

Cable box 25–26

DVD player 39

Personal Computer 41

Satellite receiver 27

VCR 36–37

## D

Detail Enhancer 84

Diagnostics 102

DIGITAL AUDIO (OPTICAL)  
OUT 19

Digital Channels 90

Digital subchannels 52

Direct Mode 82

DISPLAY button 47

Display Mode 85

Display, turning off 47

DRC Mode 82

DRC Palette 83

DTE 84

DVD player

using with remote control 50

with A/V connectors,

connecting 40

with component video

connectors, connecting 39

## E

Effect 86

English Rating 95

EXIT button 47

## F

Favorite Channels

setting up 90

using 58

FAVORITES button 47

Features 9

File 67

File Information 68

File Order 69

Filter 69

Freeze 54

FREEZE button 47, 54

French Rating 95

FUNCTION button 46

## G

Game Mode 82

Game Picture 88

Gamma Corrector 84

GUIDE button 46, 51

Guide menu 52

## H

HD/DVD IN jack (1080i/720p/  
480p/480i), described 19

HDMI 18

High Altitude 97

High-Definition Multimedia

Interface (HDMI) 10

Hue, adjusting 81

## I

i.LINK 17, 19, 73–78

i.LINK button 47

i.LINK Standby 97

Index 67

INDEX button 46

Info Banner 96

(Continued)

Infrared Receiver (IR) 16  
Inputs, labeling 96  
Iris 81, 85

## **J, K**

JUMP 54  
JUMP button 47, 54

## **L**

Label Channels 91  
Label Video Inputs 96  
LAMP LED 16  
Lamp, replacing 104–107  
Language 97

## **M**

Memory Stick  
    button 47  
    features 61  
    Index 64  
    indicator 17  
    playing movies 66  
    precautions 70  
    removing 63  
    Slide Show options 68  
    slot 17  
    troubleshooting 109  
    viewing photos 65  
MENU button 16, 47  
Menu Color 97  
Movie Rating 94  
MTS 87  
Music 68  
MUTING button 46

## **N**

Noise Reduction 82

## **O**

Off, turning off the TV 16  
On, turning on the TV 16  
Overscan 89

## **P, Q**

Parental Lock settings 80, 92  
Password, changing 93  
PC IN jack 18  
PC Input 85, 87, 99  
Personal Computer  
    connecting 41  
    Picture 81, 85

PICTURE button 46  
Picture Mode 81  
    Pro 81  
    Standard 81  
    Vivid 81  
POWER button 16, 47  
Power Saving 97  
POWER/STANDBY LED 16  
Print 67  
Print Quantity 67  
Program Guide 52  
Program Options menu 52  
Protect 67

## **R**

Ratings  
    setting 94  
    viewing blocked programs 93  
REC button 47  
Remote control  
    inserting batteries 45  
    programming 48–49  
Removing channels from the  
    channel list 91  
Removing the CableCARD  
    Device 33  
Repeat 68  
Reset 85  
RESET button 47

## **S**

S VIDEO jack, described 17, 18  
Satellite receiver  
    connecting 27  
Satellite receiver, using with  
    remote control 50  
Screen settings 79, 88  
Select Country 93  
Select Folder 69  
Settings  
    Applications 80, 101  
    Audio 79, 86  
    Channel 80, 90  
    Parental Lock 80, 92  
    Screen 79, 88  
    Setup 80, 96  
    Video 79, 81  
Setup settings 80, 96  
Sharpness, adjusting 81  
Show/Hide Channels 91  
SLEEP button 46

Slide Advance 68  
Slide Show 67  
Sound Mode 86, 87  
Speaker 16, 87  
Specifications 115  
Steady Sound  
    adjusting 86  
Support Belt 14  
Surround sound 86

## **T, U**

Timer  
    indicator 12  
    set current 102  
TIMER LED 16  
Timer setting 101  
Transition Effect 68  
Treble, adjusting 86  
Troubleshooting 108–114  
Turning on/off the TV 16  
TV Rating 94  
TV/VIDEO button 47  
Twin View 55  
Twin View button 46  
U.S.A. Rating 94  
Unrated 94

## **V**

VCR  
    using with remote control 50  
    with cable box, connecting 97  
    with cable, connecting 36  
Vertical Center 89  
Vertical Size 89  
VHF/UHF jack, described 18  
VIDEO 8 (PC) IN 18  
Video inputs, labeling 96  
Video settings 79, 81  
VIDEO/AUDIO (L/R) jacks,  
    described 17  
View 67  
VOL +/- button 46  
VOLUME +/- button 16

## **W, X, Y**

White Balance 84  
WIDE button 46  
Wide Mode 88  
Wide Screen Mode, described 10







<http://www.sony.net/>

Printed on 100% recycled paper.

Printed in Japan

---