

Service  
Service  
Service

14AA3329/10B/16B/19B/40B

14AA3527/00B/01B/05B/16B

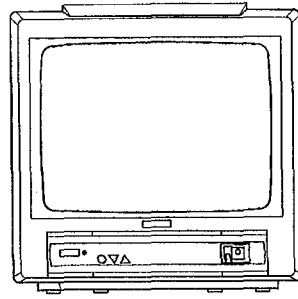

CL 26532103/011  
220692

Service manual 4822 727 19571 is herewith cancelled

# Service Manual

Safety regulations require that the set be restored to its original condition and that parts which are identical with those specified be used.

Les normes de sécurité exigent que l'appareil soit remis à l'état d'origine et que soient utilisées les pièces de rechange identiques à celles spécifiées.

## CHASSIS ANUBIS A

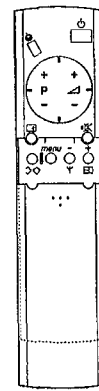
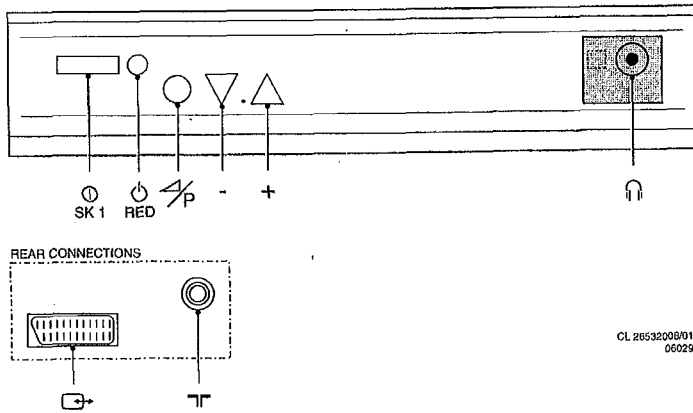

RC 9070  
CL 26532105/011  
23-06-92  
**RC9070**  
14AA3329

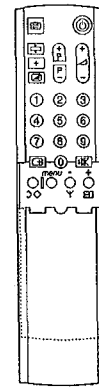

RC 9073  
CL 26532182/012  
281032  
**RC9073**  
14AA3527

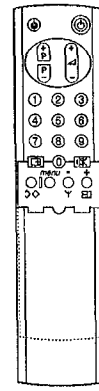

RC 9076  
CL 26532106/012  
23-05-92  
**RC9076**  
14AA3327



220-240 V (± 10%)  
48 W



A34JFQ40X04  
4822 131 20316

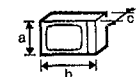

axbxc  
358x354x363 mm



1x1W



-/00/10/16 : PAL B/G

-/19 : PAL B/G/I  
SECAM B/G/L/L'

-/01/40 : PAL B/G  
SECAM B/G/L/L'/I

-/42 : PAL B/G  
SECAM B/G/D/K

-/05 : PAL I



**UV917E**  
VHFa : 46-118 MHz  
VHFb : 118-300 MHz  
UHF : 470-861 MHz

**UV915E**  
Only for -/01-/42  
VHFa : 46-118 MHz  
VHFb : 118-300 MHz  
Hyper : 300-470 MHz  
UHF : 470-861 MHz

**UV943C**  
Only for -/05  
UHF : 470-861 MHz



**PHILIPS**

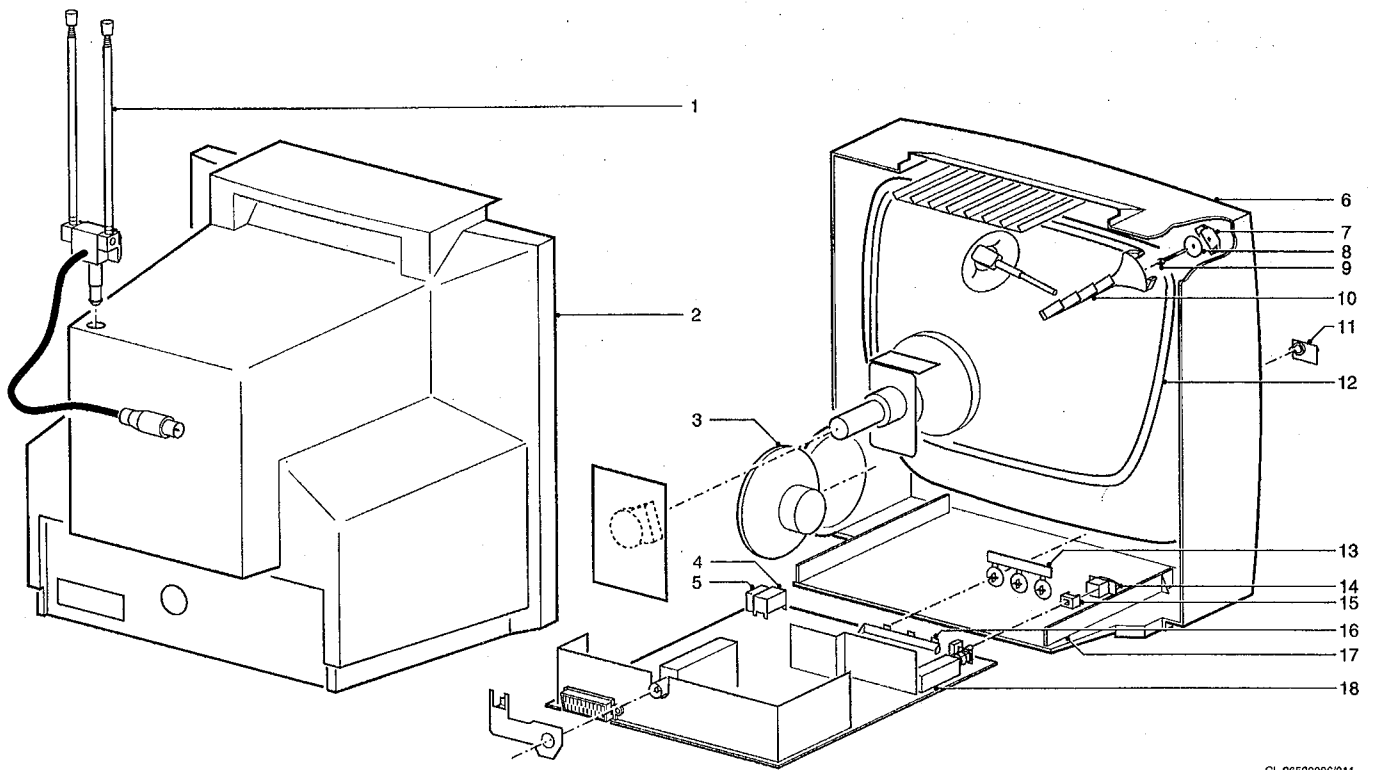

CL 26532006/011  
120292

1	4822 303 40058	Aerial for -/05
1	4822 303 30434	Aerial
2	4822 438 10386	Rear cover
3	4822 240 30583	Loudspeaker
4	4822 218 20981	RC5 receiver
5	4822 267 31292	Headphone socket
6	4822 430 10431	Cabinet for 14AA3527
6	4822 430 10399	Cabinet
7	4822 466 93169	Plate
8	4822 532 52483	Round washer
9	4822 502 21245	Screw
10	4822 404 30753	bracket fixing degaussing coil
11	4822 450 61954	RC window
12	4822 157 52316	Degaussing coil
13	4822 413 41769	Button assy for controls for 14AA3527
13	4822 410 62193	Button assy for controls
14	4822 410 62195	Button for mains
15	4822 404 31013	coupling piece
16	4822 276 13307	Switch assy for controls
17	4822 404 31248	PCB guide right
18	4822 276 12597	Mains switch
	4822 218 21139	RC9073 for 14AA3527
	4822 218 21117	RC9076 for 14AA3327
	4822 218 21115	RC9070 for 14AA3329
7600	4822 209 31691	Microprocessor TMP47C434N-3145
	4822 209 32139	Microprocessor TMP47C834N for 14AA3527