

Service
Service
Service

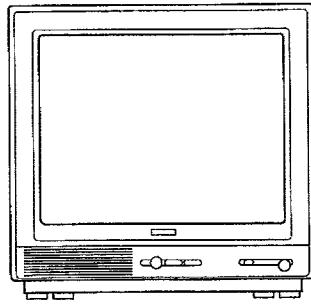

CL 26532053/035
220992

52ZY3535

/03B/05B/06B/08B/13B

/16B/22B/25G/26B/33B

215333PQ/39B

Service manual 4822 727 19548 is herewith cancelled

Service Manual

Safety regulations require that the set be restored to its original condition and that parts which are identical with those specified be used.

Les normes de sécurité exigent que l'appareil soit remis à l'état d'origine et que soient utilisées les pièces de rechange identiques à celles spécifiées.

CHASSIS ANUBIS B

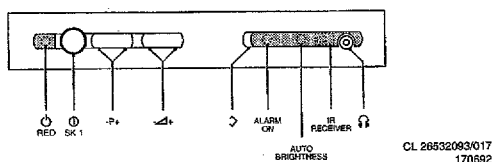

CL 26532093/017
170592

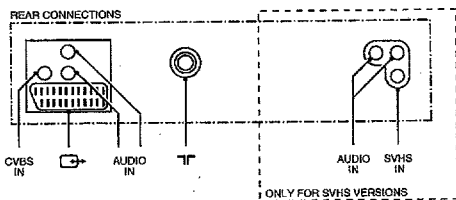

ONLY FOR SVHS VERSIONS
CL 26532093/012
120692

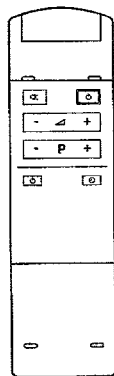

RC9051

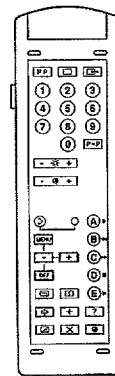

CL 26532053/013
120692

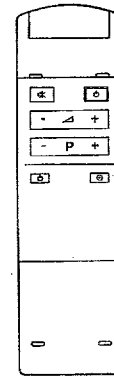

RC9055

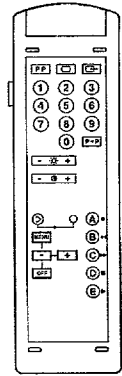

RC 9055
CL 26532154/012
140992



220-240 V (± 10%)
47 W



A51EAM31X45
4822 131 20324

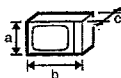

axbxc (mm)
501x472x471



1x3 W



-/03/08/13 : PAL B/G
-/16/22/33 : PAL B/G/I
-/06/26/38/39 : PAL B/G/I
SECAM B/G/L/L'
-/05/25 : PAL I



UV917E
VHFa: 46-118 MHz
VHFb: 118-300 MHz
UHF: 470-861 MHz
UV915E: -/26/33/38/39
VHFa: 46-118 MHz
VHFb: 118-300 MHz
Hyper: 300-470 MHz
UHF: 470-861 MHz
UV943E: -/05/25
UHF: 470 - 861 MHz

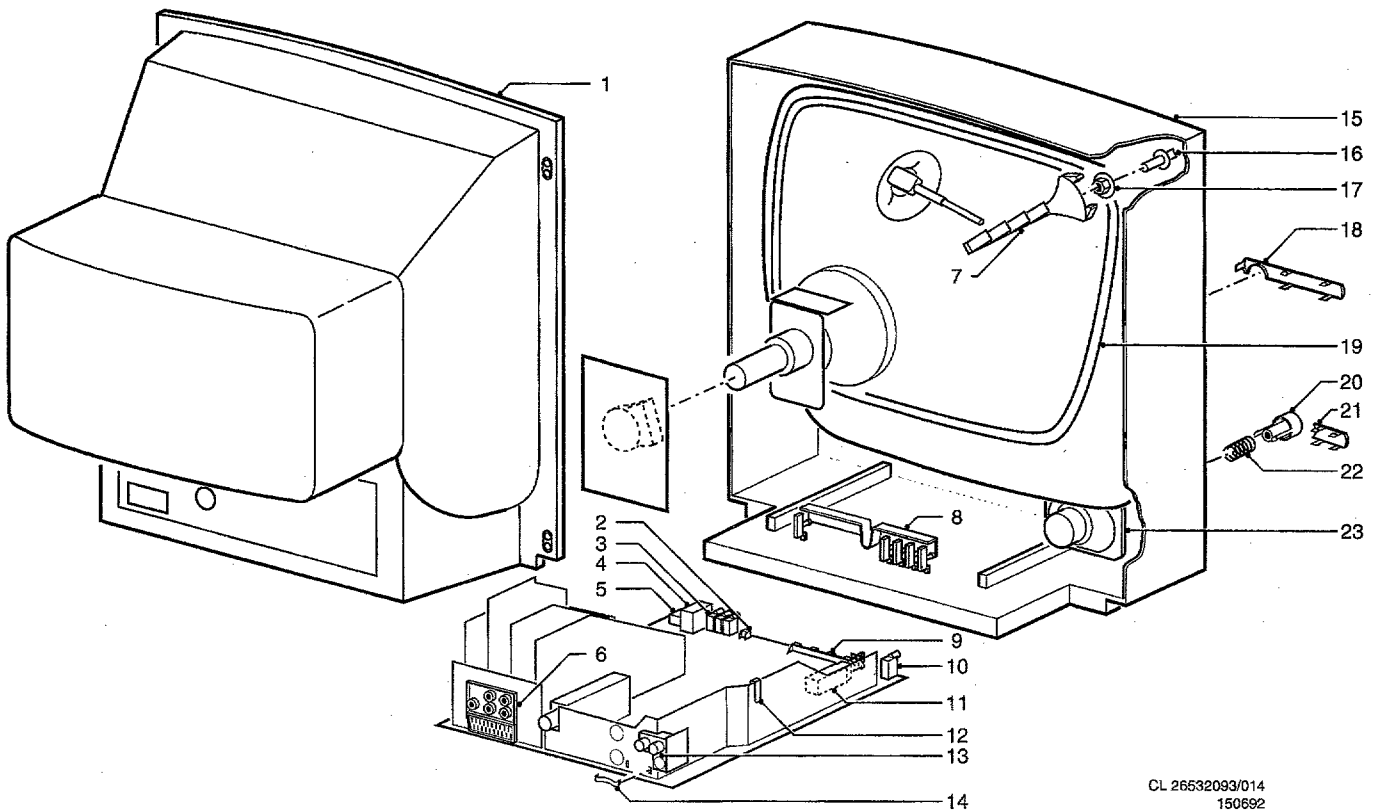

CL 26532093/014
150692

1	4822 438 40227	Rear cover
1	4822 438 40242	Rear cover for -/25G
1	4822 438 40241	Rear cover for 52ZY3523
1	4822 438 20229	Rear cover for 215333PQ
2	4822 276 13269	Switch, one-fold
3	4822 255 40955	LED holder
4	4822 218 20981	RC5 receiver
5	4822 267 31488	Headphones jack 3.5mm
6	4822 267 20428	Scart/ 3 cinch connector
7	4822 404 31238	Coil bracket
8	4822 410 61971	Push button assy
8	4822 410 62131	Push button assy for -/25G and 215333PQ
9	4822 277 21438	Switch, four-fold
10	4822 256 91918	LED holder
11	4822 276 12597	Mains switch
12	4822 249 70559	Spring for transistor
13	4822 267 20387	SVHS socket only for 52ZY3523/215333PQ
14	4822 492 70788	Spring for IC
15	4822 430 40214	Cabinet
15	4822 430 30211	Cabinet for -/25G
15	4822 430 40218	Cabinet for 215333PQ
16	4822 503 12865	Spindle
17	4822 505 10903	Nut
18	4822 381 11326	RC lens
19	4822 157 52155	Degaussing coil
20	4822 410 61969	Mains knob
21	4822 432 92899	LED cover
22	4822 492 32656	Spring
23	4822 240 30505	Loudspeaker
	4822 218 21093	Remote Control RC9051
	4822 218 21103	Remote Control RC9055 for 52ZY3523/215333PQ