

Service
Service
Service

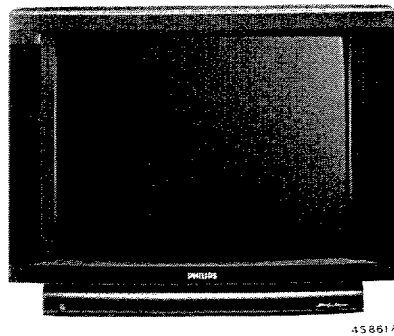

45861A

21ST2931/10B/16B
21ST2937/19B
25ST2961/10B/16B
25ST2967/19B
28ST2181/10B
28ST2281/10B
28ST2287/19B
28ST2981/10B/16B
28ST2987/19B

Service Manual

Safety regulations require that the set be restored to its original condition and that parts which are identical with those specified be used.

Les normes de sécurité exigent que l'appareil soit remis à l'état d'origine et que soient utilisées les pièces de rechange identiques à celles spécifiées.

**Chassis GR2.2
+GR2-SAT box**

Sat panel

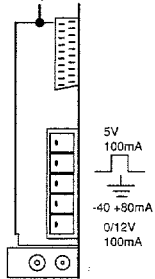

CL 26532123/012
210792

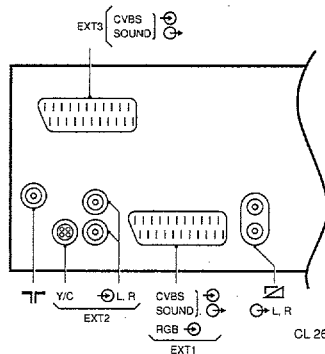

CL 26532099/013
210792

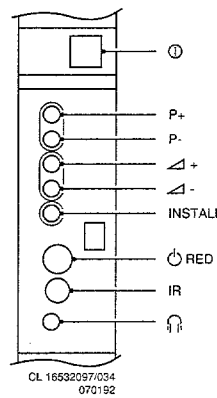

CL 16532097/034
070192

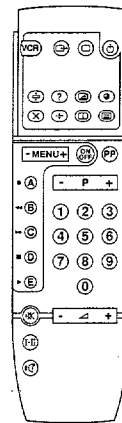

RC6512
CL 26532107/011
240682

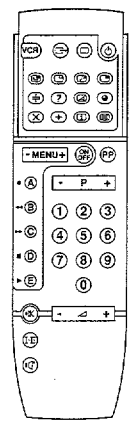

RC6513
CL 26532053/021
290692



220-240 V (± 10%)
21": 105 W max.
25": 160 W max.
28": 170 W max.

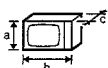

axbxc
21": 631x461x446 mm
25": 685x506x470 mm
28": 743x555x458 mm

-/10



: PAL BG

-/16

: PAL BG NICAM

-/19

: PAL BGI
SECAM BGLL'



UV916: 45-889 MHz



2x20W
2x10W for 21"
8Ω



PHILIPS

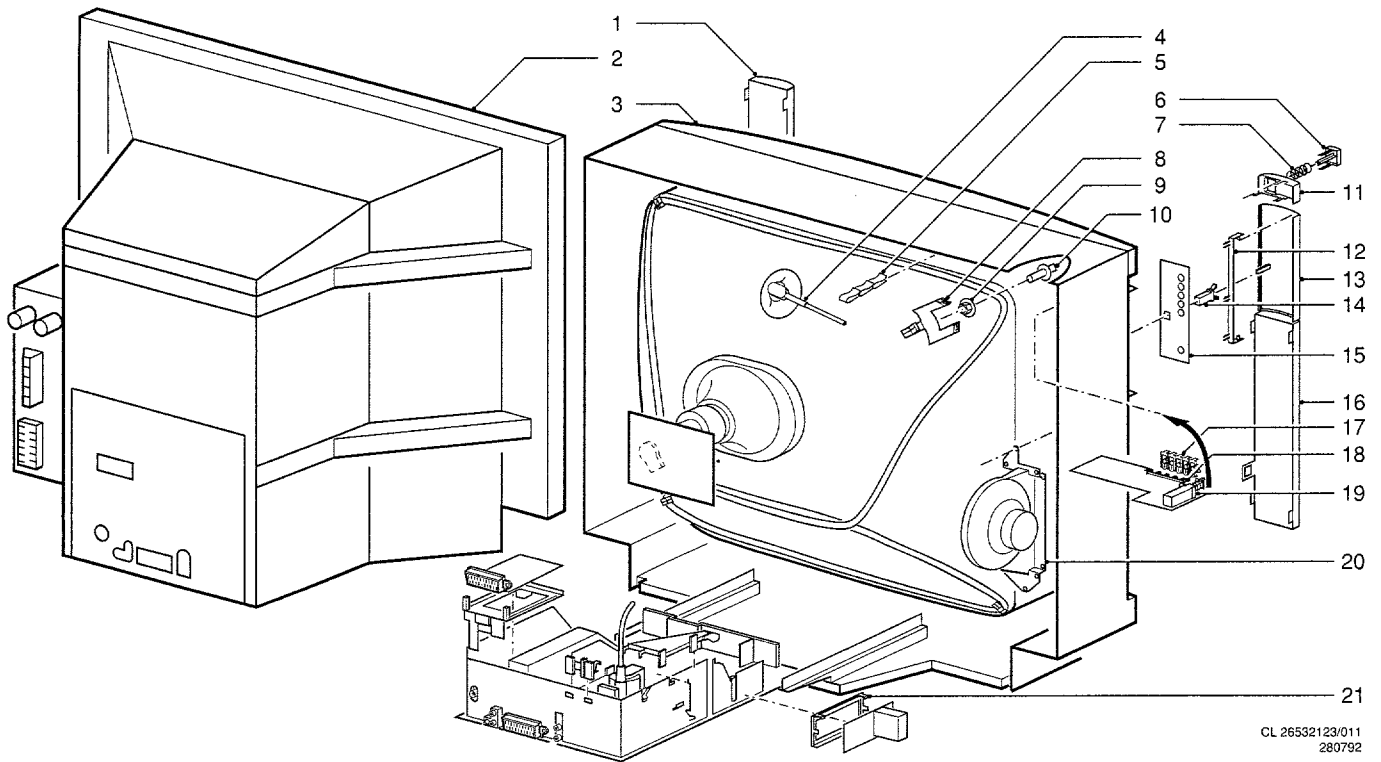

CL 26532123/011
280792

1	4822 458 50424	Grill right/left 21"	16	4822 458 50437	Grill left 25"
1	4822 458 50438	Grill right 25"	16	4822 458 50426	Grill left 28"
1	4822 458 50427	Grill right 28"	17	4822 410 61347	Control knob assy
2	4822 438 40232	Rear cover 21"	18	4822 276 50354	Switch assy for controls
2	4822 438 40246	Rear cover 21ST2131	19	4822 276 12597	Mains switch
2	4822 438 30248	Rear cover 25"	20	4822 240 40201	Loudspeaker assy right/left
2	4822 438 40247	Rear cover 28"	21	4822 404 31181	Mains module bracket
2	4822 438 40225	Rear cover 28ST29..			
3	4822 430 40215	Cabinet 21"			
3	4822 430 50871	Cabinet 25"			
3	4822 430 50867	Cabinet 28"		4822 157 62613	Degaussing coil 21"
3	4822 430 50869	Cabinet 28ST29..		4822 157 63747	Degaussing coil 25"
4	4822 320 20182	EHT cable for 21"		4822 157 63752	Degaussing coil 28"
4	4822 320 20172	EHT cable for 25"/28"		4822 131 20483	Picture tube A51EAL55X73
5	4822 404 30709	Degaussing coil clip only for 25"/28"		4822 131 20487	Picture tube A59EAK222X13
6	4822 410 62029	Mains knob 21"		4822 131 20472	picture tube A66EAK222X13
6	4822 410 62031	Mains knob 25"/28"		4822 502 13712	Screw 12x3 mm
7	4822 492 32656	Spring behind mains knob		4822 256 91886	Holder for CRT
8	4822 404 30945	Deg. coil bracket 21"		4822 218 21079	Remote control RC6512 for .. ST21..
8	4822 404 30869	Deg. coil bracket 25"/28"		4822 218 21122	Remote control RC6513
9	4822 505 10903	Picture tube nut		4822 432 92761	Battery cover RC65..
10	4822 502 12865	Picture tube spindle		4822 432 92762	Top cover RC65..
11	4822 432 92915	Cover for mains knob 25"/28"		4822 462 30542	PCB Guide for control unit
12	4822 417 11164	Hinge 25"/28"		4822 462 30543	PCB Guide right mono carrier
13	4822 432 92872	Door 21"		4822 462 30544	PCB Guide left mono carrier
13	4822 432 92916	Door 25"/28"			
14	4822 417 50252	Locking mechanism			
15	4822 460 10987	Indication strip 21"			
15	4822 460 10986	Indication strip 25"/28"			
16	4822 458 50424	Grill right/left 21"			