

Service
Service
Service

01B/05B/13B

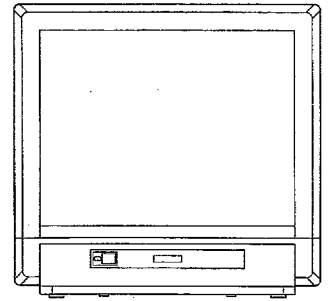

CL 26532101/011
170692

Service Manual

Safety regulations require that the set be restored to its original condition and that parts which are identical with those specified be used.

Les normes de sécurité exigent que l'appareil soit remis à l'état d'origine et que soient utilisées les pièces de rechange identiques à celles spécifiées.

CHASSIS ANUBIS B

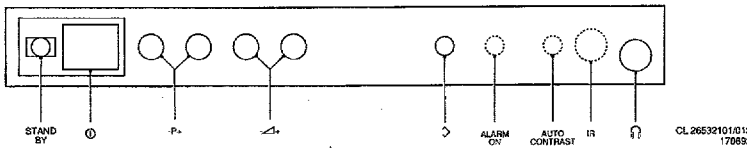

CL 26532101/012
170692

REAR CONNECTIONS

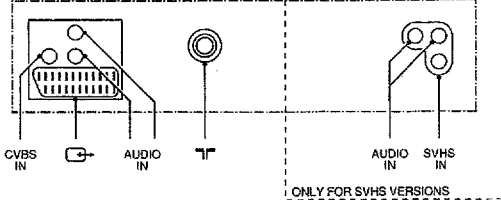

CL 26532101/013
170692

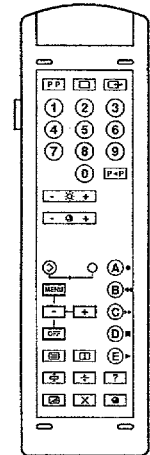
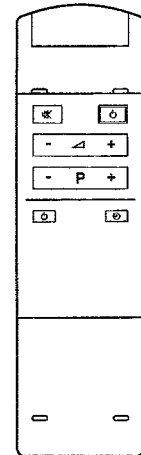

CL 26532093/013
120692

RC9051



220-240 V (± 10%)
52 W

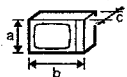

axbxc
508x475x470 mm



1x3 W



-/00/13 : PAL BG
-/01 : PAL BGI
SECAM BGLL'
-/05 : PAL-I



UV915E
Only for -/01/13
VHFa : 46-118 MHz
VHFb : 118-300 MHz
Hyper : 300-470 MHz
UHF : 470-861 MHz

UV917E
Only for -/00
VHFa : 46-118 MHz
VHFb : 118-300 MHz
UHF : 470-861 MHz

U943C
Only for -/05
UHF : 470-861 MHz



PHILIPS

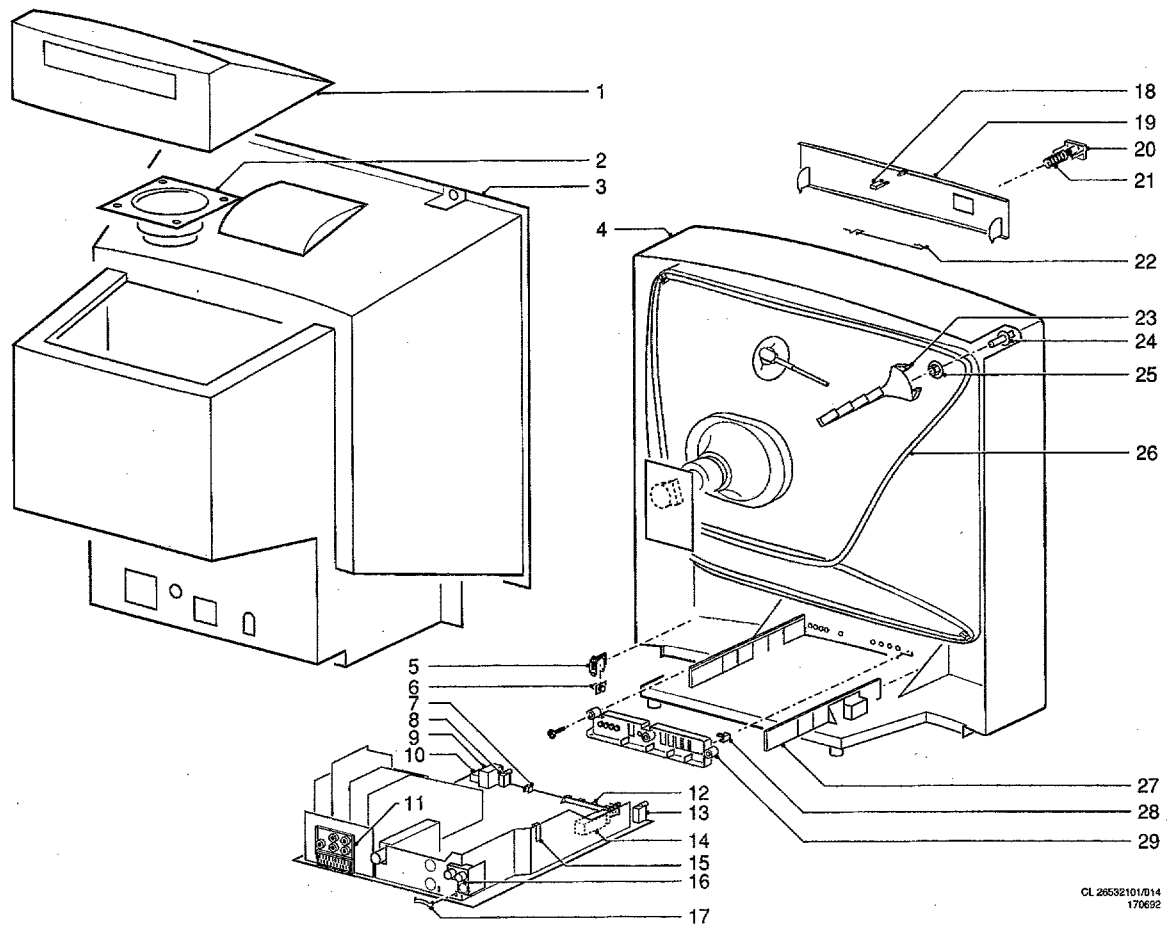

CL 26532101/014
170692

| | | |
|----|----------------|--------------------------|
| 1 | 4822 445 10325 | Loudspeaker box |
| 2 | 4822 240 30638 | Loudspeaker |
| 3 | 4822 438 40239 | Rear cover |
| 4 | 4822 430 30209 | Cabinet |
| 5 | 4822 404 31237 | Bracket for damper |
| 6 | 4822 522 31741 | Damper |
| 7 | 4822 276 13269 | Switch 1-fold |
| 8 | 4822 255 40955 | Holder for LED |
| 9 | 4822 218 20981 | Receiver for RC |
| 10 | 4822 267 31488 | Connector headphones |
| 11 | 4822 267 20387 | Scart +3 cinch |
| 12 | 4822 277 21438 | Switch 4-fold |
| 13 | 4822 256 91918 | Holder for standby LED |
| 14 | 4822 276 12597 | Mains switch |
| 15 | 4822 492 70559 | Spring for transistor |
| 16 | | Not used |
| 17 | 4822 492 70788 | Spring for IC |
| 18 | 4822 278 10088 | Locking switch |
| 19 | 4822 432 92938 | Door |
| 20 | 4822 410 62129 | Mains knob |
| 21 | 4822 492 32656 | Spring behind mains knob |
| 22 | 4822 492 71148 | Spring for door |
| 23 | 4822 404 31238 | Bracket |
| 24 | 4822 502 12865 | Spindle |
| 25 | 4822 505 10903 | Nut |
| 26 | 4822 157 52155 | Degaussing coil |
| 27 | 4822 462 30557 | Guide |
| 28 | 4822 381 11358 | Lens |
| 29 | 4822 410 62132 | Knob frame |

4822 218 21092 Remote control RC9051