

Service
Service
Service

/16B/22B

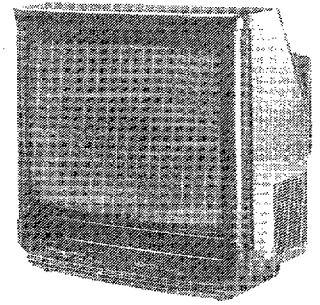

Service Manual

Safety regulations require that the set be restored to its original condition and that parts which are identical with those specified be used.

Les normes de sécurité exigent que l'appareil soit remis à l'état d'origine et que soient utilisées les pièces de rechange identiques à celles spécifiées.

CHASSIS ANUBIS B

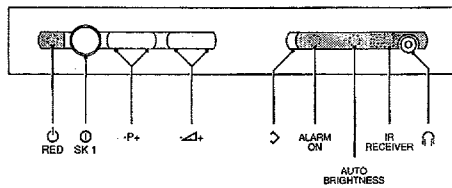

CL 26532093/017
170692

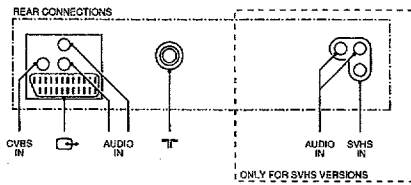

CL 26532093/012
120692

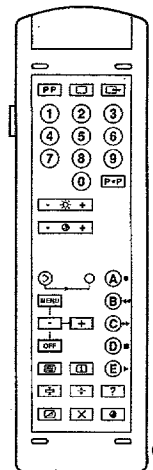
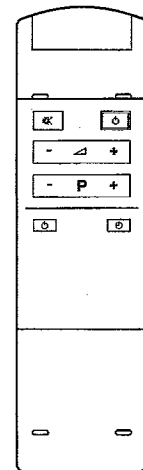

CL 26532093/013
120692

RC9051



A36EAM11x13
4822 131 20438



220-240 V (± 10%)
47 W

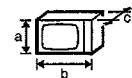

axbxc (mm)
372x369x372



1x3 W



-/03 /08
-/16 /22

: PAL B/G



UV917E

VHFa: 46-118 MHz
VHFb: 118-300 MHz
UHF: 470-861 MHz

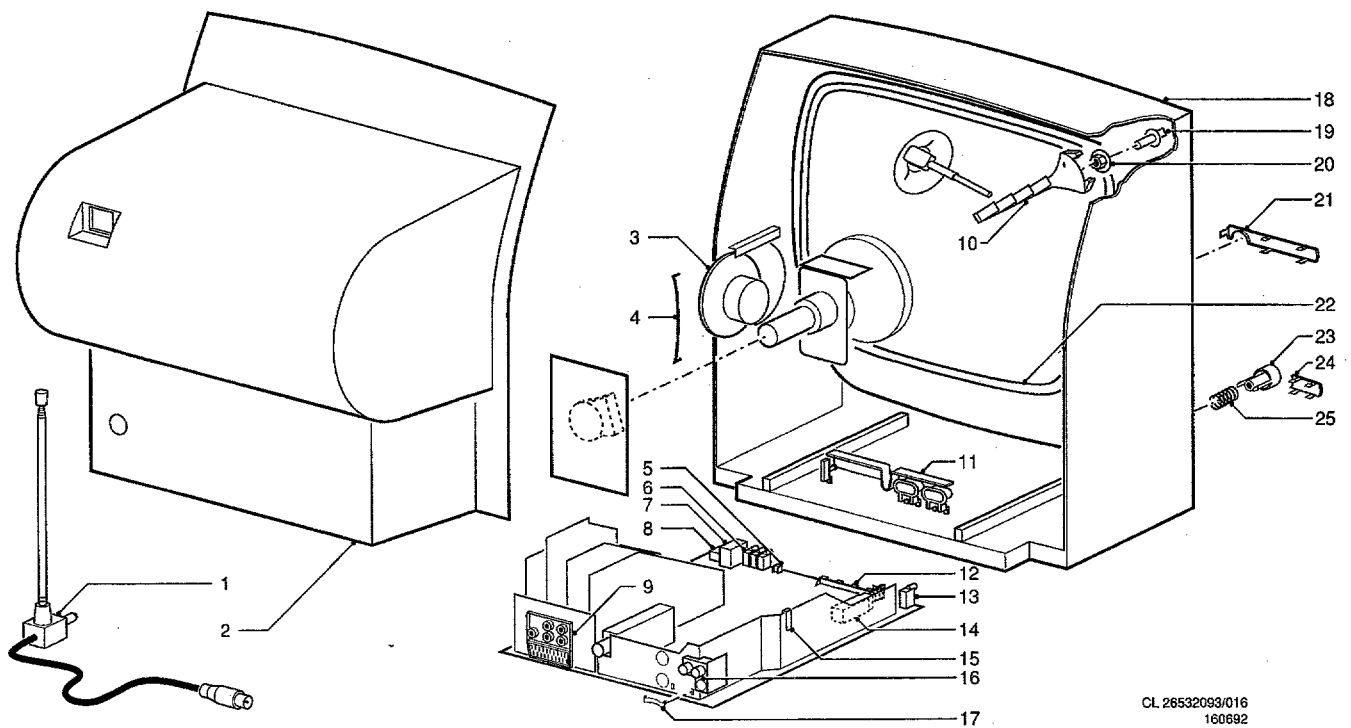

CL 26532093/016
160692

1	4822 303 50057	Ariel assy
2	4822 438 10383	Rear cover
3	4822 240 30583	Loudspeaker
4	4822 492 70215	Spring
5	4822 276 13269	Switch, one-fold
6	4822 255 40955	LED holder
7	4822 218 20981	RC5 receiver
8	4822 267 31488	Headphones jack 3.5mm
9	4822 267 20428	Scart/ 3 cinch connector
10	4822 404 30753	Bracket
11	4822 410 61971	Push button assy
12	4822 277 21438	Switch, four-fold
13	4822 256 91918	LED holder
14	4822 276 12597	Mains switch
15	4822 249 70559	Spring for transistor
16	4822 267 20387	SVHS socket only for 52ZY3523
17	4822 492 70788	Spring for IC
18	4822 430 10387	Cabinet
19	4822 503 12865	Spindle
20	4822 505 10903	Nut
21	4822 381 11328	RC lens
22	4822 157 51636	Degaussing coil
23	4822 410 62005	Mains knob
24	4822 381 11329	lens for LED
25	4822 492 32656	Spring
	4822 218 21093	Remote Control RC9051