

AUTOMOBILE ELECTRONICS

&

4-stroke engines

ENGINE COMPUTER
ECU — ECM
ENGINE DIAGNOSTICS
OBD — II
OBD-II/SAE ACRONYMS
TURBINE and INTERCOOLER
DIAGNOSTIC ADVISOR

ENGINE SENSORS
MAF-MAP-CKP-KNOCK
O2-TPS-ECT-IAT-CID-CTS
ENGINE ACTUATOR
ISC-RGB-VTEC
ABS
FUELS and LUBRICANTS



Radovan MARIN



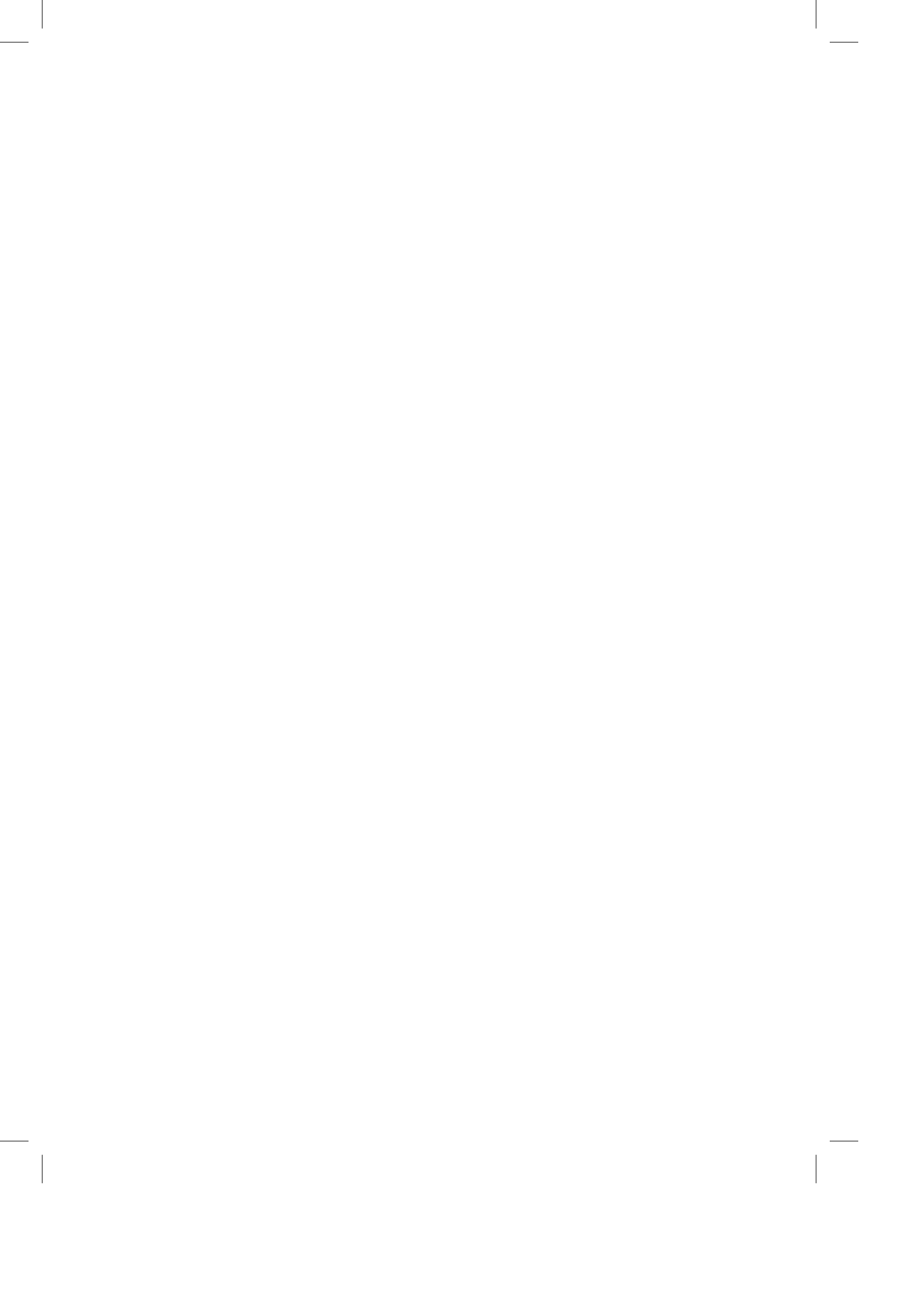



Author

Radovan Marin
General Automobile Engineer
British Institute of Engineering Technology
Aldermaston College
Reading, England

Reviewer

Dr. sc. Darko Biljaković

Editor

**and
graphic design
Radovan Marin**

Publisher



ZAGREB
Kamaufova 2
www.auto-mart.hr

Print

E-book

Zagreb, May 2011.

**CIP record is available in the computer catalog of the National University
Library in Zagreb under the number
ISBN 978-953-95888-2-1**

R E V I E W

With pleasure and interest I read the manual-tutorial book "Automobile Electronics and 4-stroke engines", written by Radovan Marin.

Until recently, the electronic part of our car was a relatively autonomous and far less developed than today. The latest models are practically saturated with electronics and it is increasingly difficult to separate mechanic from electronics. It is extremely fortunate to have a book that combines a complex technical subject matter with practical needs. Professional terminology is carefully selected, based on the common technical language. Matter is uniformly distributed, where the author deliberately avoids overly technical or scientific aspects, which could excessively increase the scope of this book and reduce its practical value, requiring extensive knowledge of the matter as well as great practical experience.

The book abounds with illustrations, which are carefully selected to neutralize the problem of many different types of vehicles and visually assisting in understanding the basic principles of electronic and related mechanical systems. The author very clearly shows how our modern car is like a living organism where there is a complex interplay of electronics and mechanics, as there is (of course much more complex) interaction between the nervous and other vital systems. And finally he gives useful and practical tips.

I believe that this book will be a great help to professionals and curious amateurs.

Dr. sc. Darko Biljaković



FOREWORD

At the present time it is almost impossible to deal with cars, either professionally or as a hobby, if we are not fully familiar with the vehicle electronic elements.

Unlike the not-so-late seventies and eighties, when the vehicle repair and maintenance required only the knowledge of mechanics, electricians and partially electronics, today it is almost unthinkable to get involved in such business without good knowledge of electronics and functions of all electronic engine components.

Due to the lack of knowledge, today we often meet with expressions: engine computer or car electronics is gone. In fact, I used to say, if we do not know how something works, there is no way to diagnose the problem.

Of course, today we commonly use diagnostic tools. But I often meet people who know how to read diagnostic trouble codes but not being able to define the function of the defective element. In any case, the diagnostic tools are a huge help in fault diagnosing. However, it often happens that diagnostic device shows no error and malfunction of the vehicle engine is evident. In such cases, knowledge comes to the fore. In addition, discovered diagnostic trouble code by diagnostic device does not give a concrete definition of failure, but only focuses on a specific part of the engine on which some tests have to be done to determine the malfunction.

Therefore, the purpose of this book is to introduce those with less knowledge in the world of vehicle diagnostics and fundamental functions of engine electronic components,

Author

Content:

Engine Control Unit and Engine Sensors	11
ECU, ECM Engine Control Unit	14
CKP Crankshaft Position sensor	20
CMP, CID Camshaft Position sensor	22
MAF Mass Airflow sensor	23
MAP Manifold Absolute Pressure sensor	27
IAT, MAT Intake Air Temperature sensor	29
KNOCK SENSOR detonation sensor	30
LAMBDA PROBE, O2, oxygen sensor	32
CTS Coolant Temperature Sensor	35
TPS Throttle Position Sensor.....	36
OBD On Board Diagnostics	38
ISC Idle Speed Control actuator	47
EGR Exhaust Gas Recirculation	50
VTEC Variable Timing Camshaft	52
CATALYTIC CONVERTER	55
FOUR STROKE OTTO and DIESEL - ENGINES	58
Engine ignition cycle	62
Ignition distributor	63
Transistor timing	67
Ignition timing	68
Spark plugs	71
Carburators	75
Vacuum carburators	80
Fuel pump	82
Fuel injection	84

Mono-Jetronic	86
K-Jetronic	86
Diesel engine	87
Turbine	91
Intercooler	94
Timing belt and timing chain	95
Engine lubrication system	99
Engine cooling system	102
Alternator	105
Electric engine starter	109
HID - Xenon lights	111
SAFETY AIR BAGS	113
ABS anti-blocking brake system	116
Traction control	119
OBD II/SAE Acronyms	120
DIAGNOSTIC ADVISOR	
Vehicle completely out of electric power	124
Ignition lights on but engine won't start	124
Engine turns but won't start	126
Increased fuel consumption	127
Erratic igling	128
Rattling valves and cold engine	130
Increased oil consumption	131
Cylinder head gasket	135
Poor brake efficiency	138
FUELS AND LUBRICANTS	
Engine fuels	141
Engine oil	143

ENGINE CONTROL UNIT (ECU, ECM) and ENGINE SENSORS

Engine control unit, or as popularly known, engine computer, carries the original title of the **ECU (Engine Control Unit)** or the **ECM (Engine Control Module)**.

The word, control unit, tells us that this is the most important element of an motor vehicle electronics. This, indeed we may say a

seconds with received data and sets the operating parameters. Simply put, the control units regulates the fuel injection timing and its amount. More sophisticated devices in modern cars regulate ignition timing, variable camshaft **VCT (Variable Cam Timing)**, the amount of intake air and amount



A typical example of a control unit, usually located in the engine area or in the cabin.

computer, collects data from all engine sensors and on the basis of these parameters determines the amount of fuel and time of injection, ignition timing, engine idling, etc. In any case, very complex electronic device which deals in milli-

of compressed air from turbo-charger as well as other engine peripherals.

The control unit determines the amount of fuel injected and the moment of ignition on the basis of received parameters from a series

of sensors, which are connected to it. Sensors will show the parameters of the incoming airflow to the



One of the types of MAF sensor

engine intake manifold **MAF** (Mass Air Flow sensor) and air

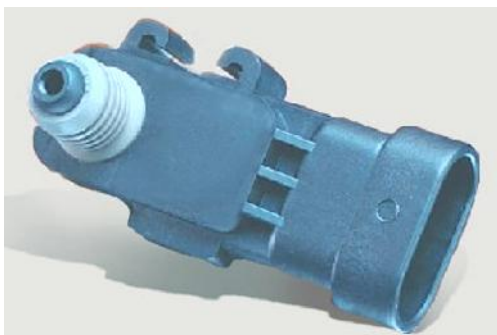

MAP sensor

pressure in the inlet manifold **MAP** (Manifold Absolute Pressure sensor), a butterfly throttle position, air temperature in intake manifolds, engine coolant temperature, crankshaft position (**CKP sensor**) and others.

Processing the received parameters in milliseconds, the control unit will determine the quantity of



Throttle position sensor - TPS sensor

injected fuel into the engine cylinders. When accelerating the engine, quantity of fuel will be proportionately increased thanks to input from sensors. Following the coolant temperature, the control unit will increase the amount of fuel injected and will also gradually reduce it as coolant temperature increases.

The control unit (hereinafter re-



CKP crankshaft sensor

ferred to as **ECU**) will adjust the ignition timing. The main information to adjust the ignition timing will come from the **CKP** sensor, which at any time shows the position of the engine crankshaft. In determining the ignition angle, the other sensor will help by registering the internal vibrations and engine knocking due to premature

ignition, which is often caused by inadequate fuel. This sensor is known as **KNOCK** sensor. In response to the vibrations signals of the sensor inside the engine and slamming, the **ECU** will adjust the angle of ignition to the fuel being used.



KNOCK sensor

Coolant temperature sensor is also connected to the **ECU** and provides information about its temperature. Disposal of data about temperature, the **ECU** will correct dosage amount of injected fuel. This type of control mixtures at different temperatures of the engine eliminates all the known principles of the, so-called, the engine "choke".



Coolant Temperature Sensor

Certainly, we must not forget the **Lambda** probe, or the original name **O₂** sensor (oxygen sensor). This chemical generator, will generate pulses of different voltage values. Voltage will vary depending on difference amounts of oxygen in the engine exhaust gases and atmospheric air. Registering different values of momentum, the **ECU** will automatically decrease or increase the amount of injected fuel.

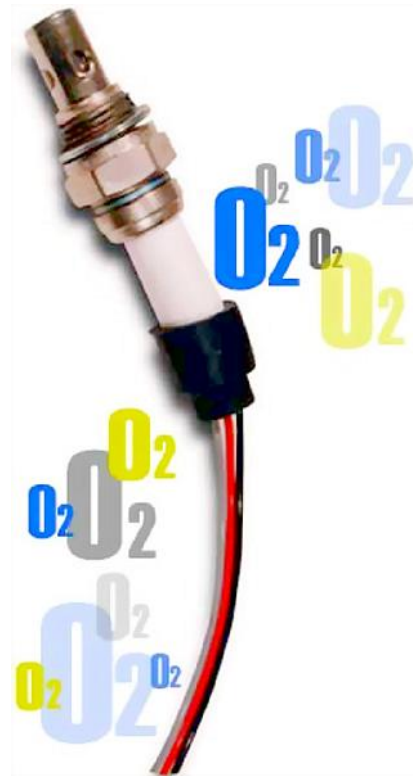

Lambda probe or (O₂) OXYGEN sensor

These are the basic components of engine electronic control operation. That is, the **ECU**, as the brain of motor management, collects information from connected sensors and controls the engine by the factory installed programs.

**ENGINE CONTROL UNIT
(ENGINE COMPUTER)
or
ECU, ECM**

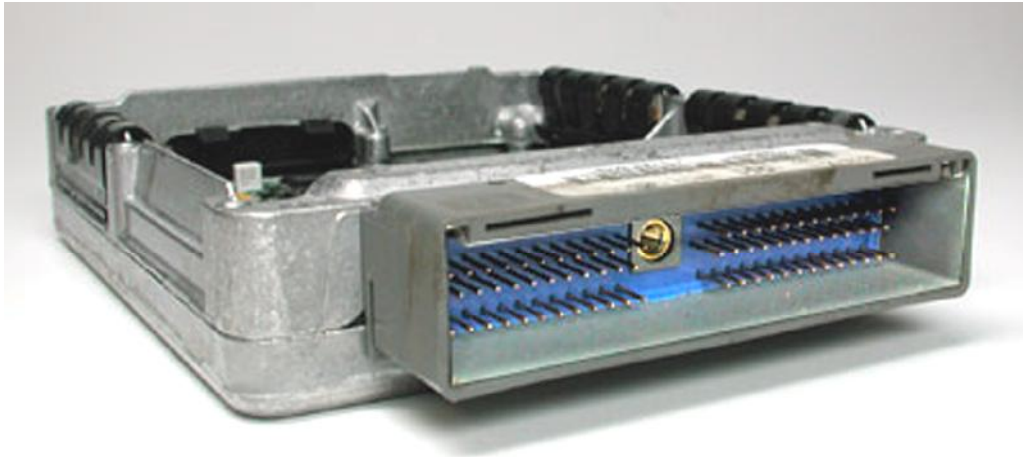

As can be seen in the above photo, multipin outlet is planned to connect the **ECU** with the engine sensors and other electrical and electronic elements of the engine. **ECU** is usually located in the cabin, but often can be found in the space of the engine compartment, as well as on the engine itself. Multipin plug is attached by screw or various kinds of coupling to the **ECU**. Such coupling will provide a good plug connector contact, as well as a seal between the plug and socket. Seal between the plug and socket is of great importance. Specifically, current and voltage flowing between the **ECU** and sensors have very small values. For that reason, contacts supposed to be perfectly clean. The presence of moisture or oxidation

will cause interruption in circuits or short circuit between the terminals. This is the reason, why accommodating **ECU** in the engine area is very inappropriate. Located in such way, **ECU**-s are exposed to moisture and are subject to breakdown due to oxidation of contacts, either at the socket, or inside the computer. Regardless of the good sealing enclosures and computer outlet, moisture will eventually find its way into their interior to create an oxide layer between the contacts and soldered surfaces. The consequences of failures in electronic systems of vehicles, caused by oxidation of compounds, usually can be solved with contact anticorrosive solvents. In case of failure of the **ECU** where the presence of oxidation is visible,

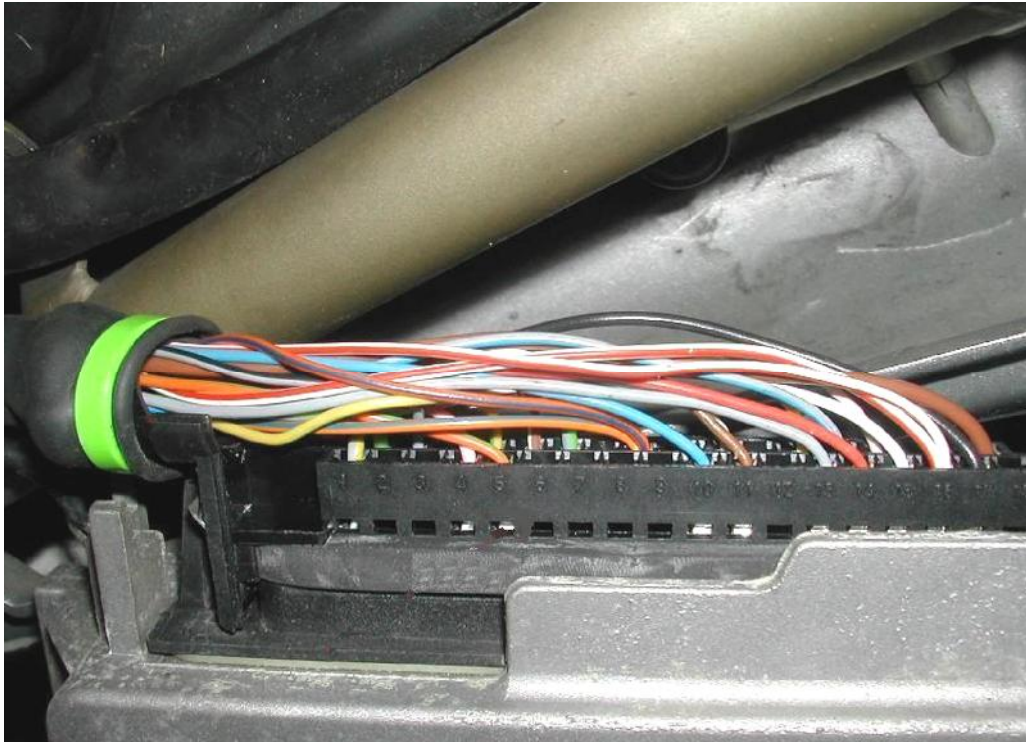

the problem can be solved by re-soldering all soldered contacts. This problem is known as a "**cold solder**" joint.

The above photo shows the multipin plug with sealing cover removed. Of course such a large number of wires acts confusing. However, it also indicates the complexity of the **ECU's** function.

With this many power lines engine computer collects information from all engine sensors, and after processing, sends a commands to electric and electronic engine actuators.

Before the world's law of emission control was defined and standardized by the amount of pollutants and toxic exhaust gases, it was possible to produce cars without the use of electronics and micro-

processors. Stricter laws forced auto industry to introduce more sophisticated methods of mixing fuel and air in order to obtain a correct mixture ratio, and hence more complete combustion. It means, only after the complete combustion of air-fuel mixture a catalyst can do its part, removing the rest of harmful gas emissions.

Controlling the engine is the biggest task of **ECU**. It is also the most powerful computer in the vehicle. **ECU** uses all the output parameters from engine and on its base provides the input information and commands. Collecting dozens of information from various sensors on the engine, the **ECU** knows everything from the engine coolant temperature to the amount of oxygen in the exhaust.

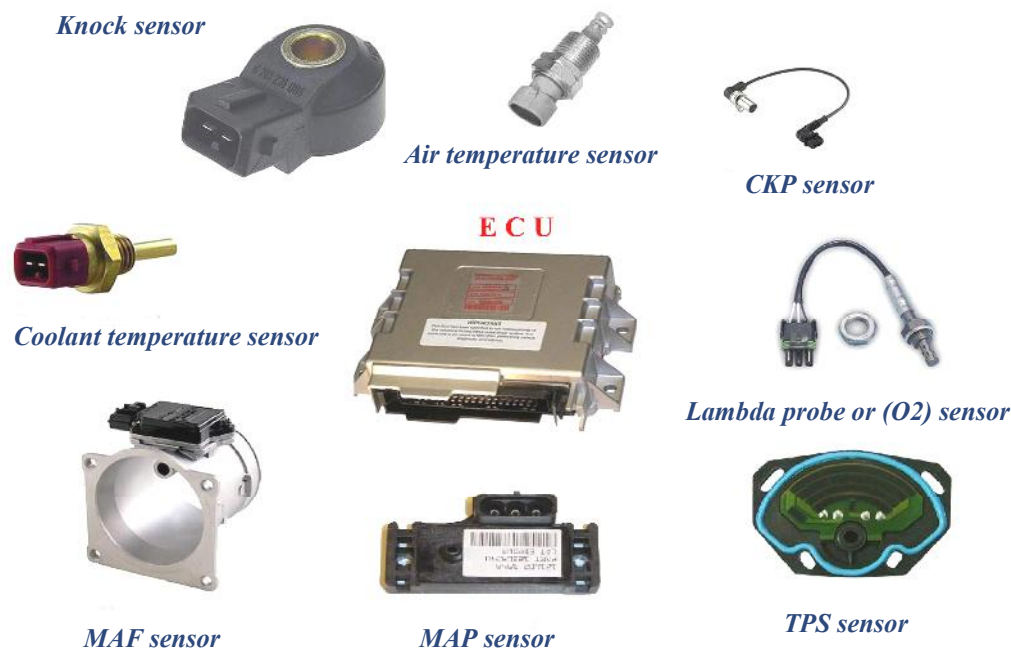

Based on data supplied by the engine sensors, computer performs millions of calculations per second, combining the mathematical equations for the optional ignition timing and duration of fuel injection into the engine. All these acts are performed by the ECU in order to reduce emission and achieve less consumption and simultaneously using the maximum engine power.

Today's motor vehicles are using 32-bit processor in ECU-s with frequency of 40 MHz. The speed of such processor may not look impressive in relation to home computers with a processor speed of up to 3 GHz and more. But keep in mind that the codes which are processed by the ECU processor take only 1 MB of memory, while programs that we use on home compu-

ters are taking up to 2 GB of memory. Thus, two thousands times less memory for processing. Comparing the weight of processing data in MB's, we get very impressive picture of ECU's processor speed. But certainly, the processor of 40 MHz is at the upper limit used in engine computers. In some modified vehicles with improved engine performances, we will find processors with frequency up to 1 GHz.

The processor is installed in the housing (module) along with hundreds of other components that make up the ECU. Some of the components which support the processor are:

Analog-digital converters

These devices read the output values of sensors, such as the lambda probe. The output value of

this sensor is analog voltage from 0 to 1.1 V. Processor recognizes only digital numbers. Therefore, the converter will convert the voltage in 10-bit digital numbers.

High level digital outputs. On most modern cars, ECU determines the moment of spark occurrence on spark plugs, opening and closing injectors, switching cooling fan on and off, activating and deactivating fuel pump etc. Digital output can only be turned on or off and there is not any middle situation or value. For example, to turn on the engine cooling fan we have to provide voltage of 12V and 0,5A current to activate fan relay, or 0V to turn it off. The question is, how to get out so much power from processor to activate fan relay. The path is as follows: very low energy from the processor will activate a transistor which also has the same function as relay. Activated transistor will provide enough energy to activate fan relay. Finally, through the fan relay will flow enough energy to run the fan. The same way, processor activates the other engine actuators.

Digital-analog converters

As previously mentioned, analog-digital converters are used to convert analog signal to digital. It is generally required when processor receives analog sensor values. However, when processor manages certain engine components, digital-analog converter is needed. Other words, voltage is received as analog signal and digital commands are sent to be converted to voltage.

This converter will convert digital signal from processor to analog as described and manage engine electric components.

Signal corrector. Due to a more accurate reading of analog signal, it must be corrected before the final readings in the processor. This is the task of this corrector which is adjusted to correct imprecise signals.

Communications chip. This chip is designed for communication with diagnostic devices. Diagnostic devices are subject to communication protocols, which determines communication chip. Since 1996, until today, five communication protocols are present on cars worldwide. Today, on new vehicles CAN (controller-area networking) protocol is dominating. We shall leave protocols aside for awhile when we shall discuss the OBD II diagnostics, which is unified for all personal vehicles since 1996. year to date in the US and good part of vehicles in other parts of the world. Since 2001. until 2003. year, in Europe all personal vehicles are subject to OBD II standards.

Microprocessor

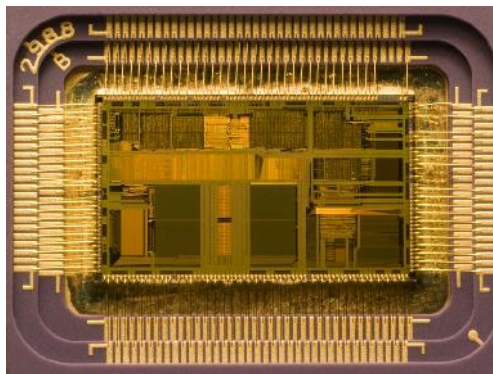



On middle-class vehicles, **ECU** is mainly factory programmed and can not be reprogrammed. However, on higher-classes vehicles, computers are built with ability to be reprogrammed and upgraded. These computers can be updated with the latest or modified software solutions for particular vehicle.

If the standard **ECU** installed in the vehicle is not reprogrammable, the market offers a wide range of **ECU's** that can be programmed and reprogrammed. One such example is shown in the above photo.

The investment of such **ECU** will engage only the vehicle owner who has made significant modifications to the engine.

Significant modifications implies the installation of modified camshafts, turbine, exhaust system, intercooler etc. In such cases, the original **ECU** probably would not be able to follow the new engine configuration and must be replaced by new ones, which can be reprogrammed or mapped.

ECU, which can be programmed, provides the ability to control the dispensing of fuel into each cylinder, what will depend of the butterfly throttle position and accelerator pedal sensors, the amount of intake air which information will provide **MAF** sensor, and air pressure in the inlet manifold which we read through **MAP** sensor. Such adjustments can be

made with appropriate programs and a laptop or desktop computer. Namely, the table of values read by sensors and driving on them is done programming or mapping the ECU. Desktop computer can be used if the vehicle is on rollers. However, in the absence of such an apparatus, the programming can be done while driving and using a laptop computer.

In the accompanying picture we

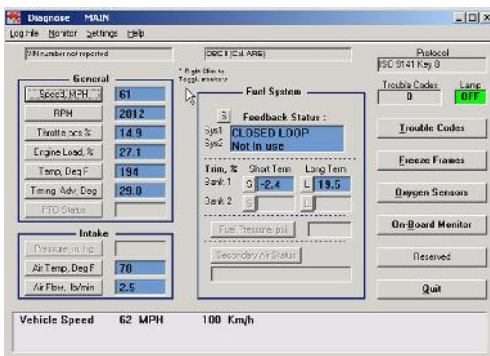

see read the parameters that are relevant for programming ECU. Based on the data and constantly monitoring the lambda probe, the computer can adjust the following: the moment of ignition, limit the maximum RPM, the turbine, cold engine operation, fuel dispensing, modifying the fuel injection at low pressure in the system and permanent monitoring of the lambda probe in order to achieve the ideal combustion mixture.

Modifying the value while setting the ECU, a lambda probe will at any time have control over the mixture and the tuner will determine the optimal amount of fuel injected in all combinations of engine RPM and throttle butterfly

positions.

In more sophisticated models of ECUs, which are used in car racing purposes, setup options are even greater. For example, we can limit the power of the engine in first gear, so as not to damage the engine and other vehicle parts. It is possible to limit the power of the turbine regulating valve routing engine exhaust gases, to precisely control twin injectors per cylinder, which are used for precise dosage of fuel and the atomization of fuel injection when the larger engine rpm. It is possible to control variable camshafts, or engine valve opening duration and monitoring of the engine when shifting sequential gearbox.

As already mentioned, the ECU has a communication chip, which allows us to check the accuracy of all data and electronic elements of the engine. However, in order to let us know about possible irregularity of engine management or its faulty before routine checking, the ECU switches warning light on dashboard which alerts drivers to an irregularity or failure of the engine. Such light is called a MIL (Malfunction Indicator Lamp), and marked with the CHECK ENGINE.

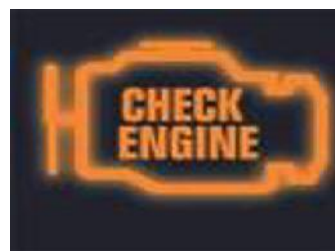

ENGINE SENSORS

CKP senzor Crankshaft Position Sensor



Crankshaft Position Sensor is a component of an electronic engine monitoring, which monitors the crankshaft **RPM** and its position relative to the piston upper dead point (**TDC**). Information of this sensor is used to determine the moment of ignition and fuel injection. Crankshaft sensor is typically used in combination with a similar camshaft sensor. This combination determines the correct relationships of engine pistons and valves. This combination is extremely important in engines with variable camshaft. However, in the middle class cars, only crankshaft sensor

is sufficient. Crankshaft and camshaft sensors consist of a core - a permanent magnet and induction coil around the core.

CKP sensor is usually located on the front of the crankshaft or the engine flywheel housing.

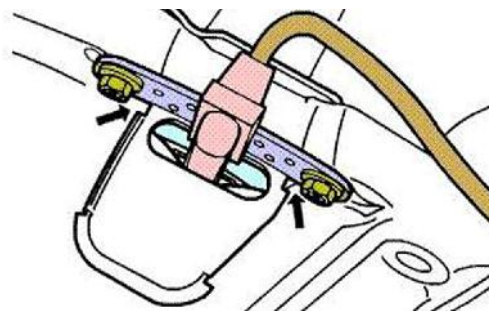

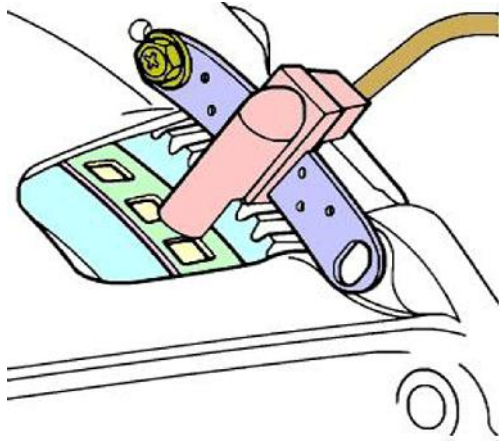

As shown in the drawing above, the sensor is located close to the perforated or serrated flywheel rim. The same situation is with accommodating sensors on the front of the crankshaft, in which case the sensor is located along the toothed timing belt pulley.

In the basic variant, the annular part of the crankshaft pulley or

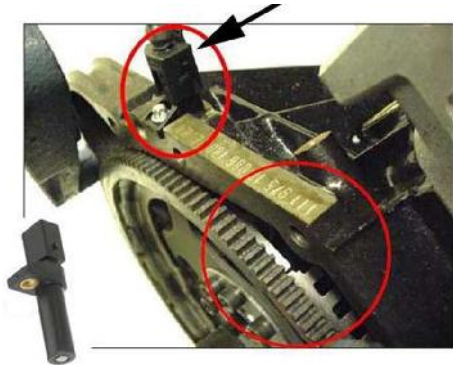

flywheel has 36 teeth, minus 1. Thirty-six teeth is the measuring field of a cycle of turning the crankshaft for 360° . One tooth missing, determines the position of the crankshaft. Of course, different models of vehicles would have a different arrangement of teeth, with the purpose of obtaining more information about crank-

shaft position.

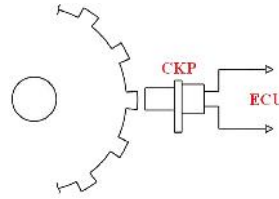

Thus, **CKP** sensor is a generator. Just by turning the engine starter, the sensor will, meeting the pulley teeth, generate voltage up to ten volts, depending of the type of vehicle. Previously, it was said that the notched part of one tooth is missing. Passing that part of pulley breaks the continuity of the voltage pulse and it will be information for the **ECU** in which position is engine crankshaft.

It is important to take into account the distance between the sensor and the top of the teeth, which is determined by the vehicle manufacturer. It should also be taken into account that between the sensor and the teeth, or in the grooves between the teeth, must not be metal particles.

Checking **CKP** sensor is very simple. It is necessary to disconnect the sensor connector and do the following: For example, on the VW Golf 1.4, 1998. Year, we will find a connector with three terminals. Terminals 1 and 3 are connected to the engine computer, while terminal 2 is connected to the ground pole of the engine. Connecting voltmeter to terminals 1 and 3, while simultaneously turning the engine starter, should get a voltage reading of 4.5 V. Terminal 2, which is connected to the

ground of the engine is wire mesh covering the terminals 1 and 3. This layer will prevent any external voltage influence on the voltage generated by sensors. That is, if the behavior occurs, it will lose its unwanted stress on the ground pole (ground is called negative or minus pole on cars). Checking the sensor can be performed by measuring the resistance between terminals 1 and 3, if we know the value of resistance.

Finally as described, **CKP** sensor usually will find in today's vehicles. These sensors send analog signals, which are in the engine computer converted to digital. However, in some types of vehicles, we find the sensors that send digital signals. Such sensors have built-in converters, which convert analog signals to digital and thus relieve the **ECU** of that task.

(**Cylinder Identification Sensor**).

Given the information that the **ECU** uses to control engine operation, a result of failure of this sensor does not necessarily mean the engine failure, as is the case with the **CKP** sensor. But in any case, there will be incorrect fuel injection and loss of engine performance. Certainly, in this case **MIL** warning light will flash.

Unlike the serration of the crankshaft pulley, cam shaft may have only one nose marking the first cylinder. However, as shown in the drawing below, there may be more teeth. This, of course, depends on the concept of electronic engine management of particular vehicle.

**CMP - CID sensor
(Camshaft Position Sensor)**



Camshaft sensor works the same way as the **CKP** sensor. Based on the **CMP** sensor pulses **ECU** will control the moment of ignition and synchronize the fuel injection. This sensor is also known as sensor **CID**



MAF sensor

Mass Airflow Sensor



This sensor is inevitable on engines with electronic fuel injection, measuring the air mass entering the engine. This information is essential to the engine computer to calculate the mixture, which will be prepared for combustion.

Air changes its density as it expands and contracts at different temperatures. Given that, vehicle engines are operating under different conditions and temperature ranges where the mass of air varies. This is an ideal sensor; based on whose data the **ECU** can calculate the proper ratio of fuel and air mixture.

The two most common types of **MAF** sensors that we meet are **VANE METER** airflow meter with a vane or blades and a **HOT WIRE** air flow meter, which works on the principle of hot wire. None of them was designed to measure air mass completely.

However, in combination with temperature and air pressure sensors, air mass can be safely calculated with great precision. Both sensors send analog voltage signals 0-5 volts in proportion to the mass flow rate.

Described sensors can be found in vehicles produced until 2000. Year. Since that time, the same sensors are considerably modified, and **VANE** sensors we almost do not see any more. In **HOT WIRE** sensors membrane foils are inserted instead of wires, and other various modifications are made. However, these sensors are still working on the same principle as previous. In newer vehicles we rarely find sensors with analog signals. In fact, today more and more sensors have built-in converter and send digital signals to the **ECU**. Such sensors have been recognized as part of an electronic structure is usually visible.

VANE MAF sensors operate on the principle of moving vanes or blades which is associated with a potentiometer or sliding resistor. By entering the air through the sensor, the sensor flap opens due to the force of air pressure. Of course, the degree of openness of the wings or blades will depend on the amount of air flow. Flap is mechanically connected with resis-

tor's slider, which will alter the voltage value depending on the position of wings, or slide.

On the coil of the potentiometer the power has been brought. The slider of the potentiometer, which will in any position close the electrical circuit between the part of coil and the source of power will reduce or increase the output voltage from the coil. As shown in the attached sketch, we put a volt meter on the coil slider, moving the wings and also the slider we get different voltage values. The potentiometer is calibrated so that from zero to full fins deflection gives the voltage in the range 0-5 V. The readout voltage of ECU

subject to failures. Failures are mostly related to improper flap deflection due to dirt deposits on the pin about which it rotates.

The next problem is the size of the flap mechanism within the sensor, which prevents the maximum air flow through the sensor. In addition, the mechanical parts such as springs, changing its calibrated value over time. For that reason, these sensors have a mechanism for adjusting the tension of fins spring. Namely, if the spring weakens over time, the deflection of the potentiometer will be higher than provided for the incoming air mass. In other words, the ECU will receive for smaller amount of air a

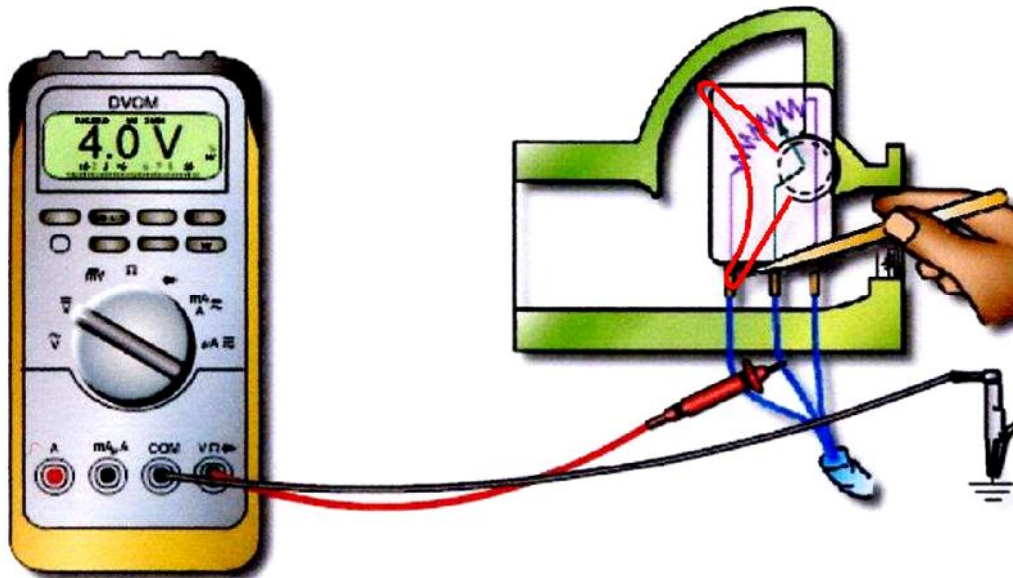

VANE MAF sensor

will turn into a mass of air g / s (grams per second).

Such sensors have proved to be impractical for several reasons. Since they were made from quite a few mechanical parts, they are

higher value in volts and so dose the greater amount of fuel. Surely, this will cause a rich mixture and higher fuel consumption, as well as loss of engine power. These were the reasons for MAF modification.

HOT WIRE MAF sensors operate on the principle of heated wire, which is cooled by air flow. The difference in the wire resistance at different temperatures will cause differences in the analog signal whose value varies between 0 and 5V.

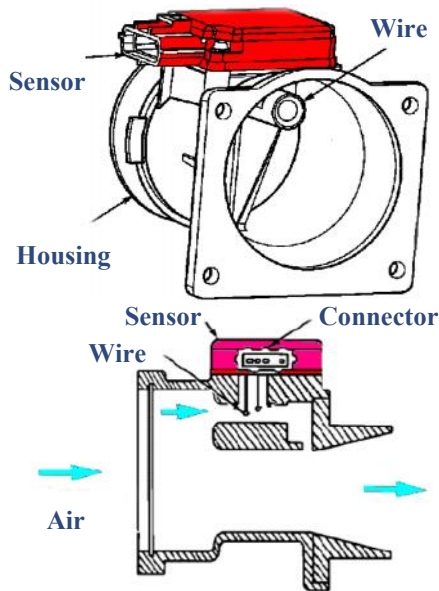

In the upper section of the sketch we see **MAF** sensor with all its specificities. Air enters the engine intake manifold through the sensor housing. As can be seen on the sketch, a small amount of air is flowing through a separate channel in the casing. In this section is a wire over which air flows. Current flows through the wire and heats it, while airflow cools it down. Increasing wire temperature, the resistance increases, and vice versa. Permanent changes in current flow through the sensor wire, module will convert it into Voltage signals 0-5 V and forward them to the **ECU**.

Unlike **VANE** sensors, this sensor will recognize the air density. Namely, denser air cools the wire more than thin air. In case of denser air, sensor will send stronger signal, just like that greater volume of air flows through the sensor.

Today's sensors are increasingly using alloy metal plates instead of wire, and built-in modules instantly converting analog signals to digital.



Above photograph shows the typical modern car sensor with visible electronic plate and module. The presented sensor works on the principle of thermal membrane. At the plastic plate, which is located in the middle of the housing, the membrane is imprinted with the metal foil on the bottom and top. Membrane warms foil plates, which react in the same way as the wire, but far more precise.

Today are also increasingly present sensors with the so-called cold wire. With these sensors, due to air flow induces a voltage, which goes to the **ECU** in the form of digital signals.

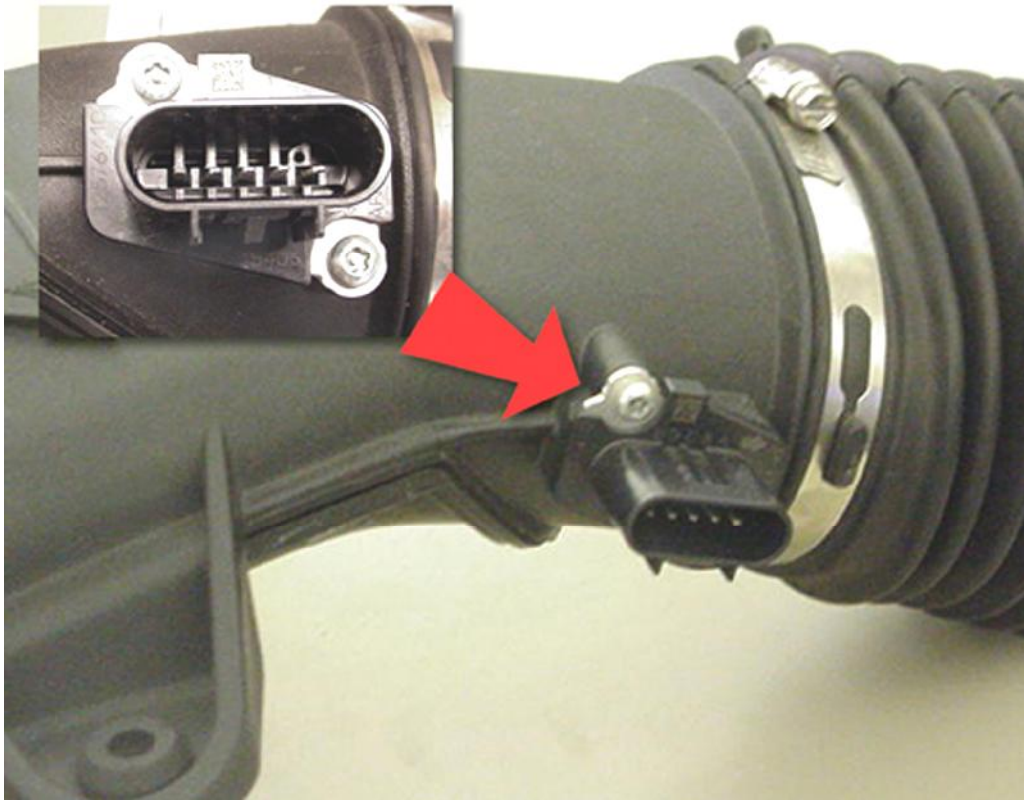

On newer generation vehicles, we will see more often air flow sensors like this one on above photo, than ones previously described.

This sensor usually works on the cold wire and sends digital signals to the ECU. Incorrect readings of sensors, which have resulted in loss of engine performance, we can usually handle only by cleaning the sensor surface. Over the time, sensor can accumulate dirt and read less airflow.

MAF Sport



MAP senzor Manifold Absolute Pressure

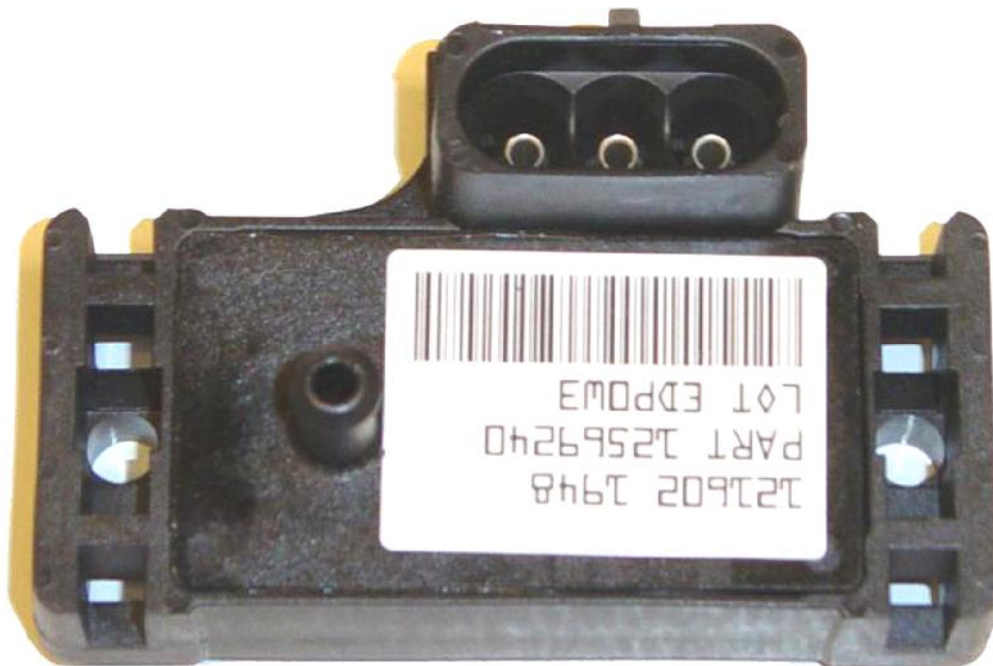

Air pressure sensor supplies the **ECU** with information about air pressure in the intake system. This information will be needed for the calculation of air density and determine the mass flow rate, which will ultimately be crucial for the calculation of the mixture.

A simple example of **MAP** sensor function: driving a car at sea level at a certain speed, the sensor will send information about air pressure, which depends on the density of air and used for the calculation of air-fuel mixture. Driving at the same speed at high altitude level, sensors data will differ from previous.

Thanks to the air sensor, the **ECU** will recognize the difference in air density in these two cases and be able to accurately determine the required amount of fuel to achieve the ideal mixture of air and fuel in relation to **14,7:1**.

As in previous cases, the sensor operates in a similar way. **ECU** powers sensor with voltage of **5V**. Silicon crystals implanted in the sensor changes resistance depending on the input air pressure. Changing resistance changes the output voltage from the sensor to the **ECU**. This signal can be analog or digital, depending on the type of sensors. As can be seen in the next

sketch, some sensors in its casing have an opening for measuring the intake manifold vacuum. The lower the vacuum, the air pressure is higher. In this situation, sensor resistance falls and output voltage signal increases, and vice versa.

The typical value of the sensor signal ranges from 0.5 to 4.5 V. On the so-called idle throttle, with a strong vacuum and low pressure, the sensor signal will oscillate between 0.5 and 1.5 V. In the middle position of throttle and the average values of vacuum and pressure, the signal voltage will be between 1.5 and 3 V and at full throttle, low vacuum and high pressure, the signal will be 4.5 V.

Outgoing signal
Voltage

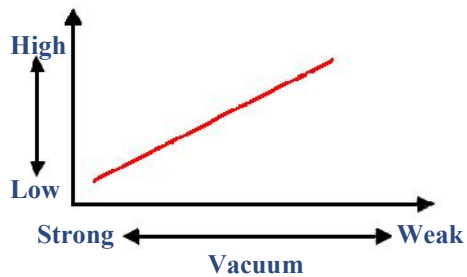

In above graph, we can see proportional growth and decrease of

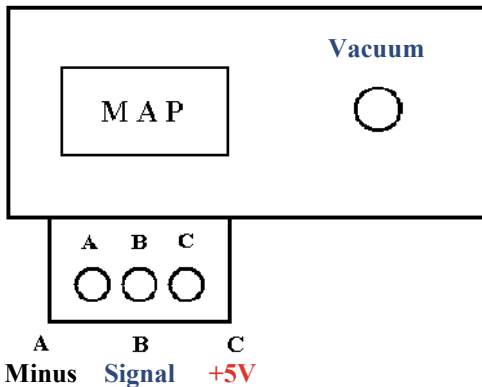

voltage in relation to vacuum fluctuations.

Different types of MAP sensors

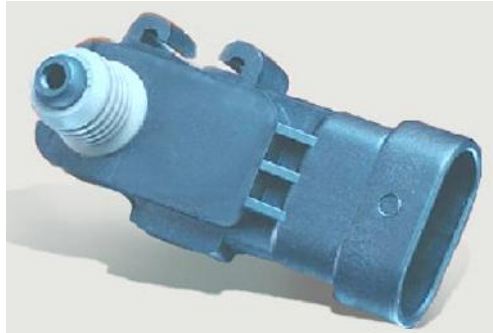

IAT, MAT sensor Intake Air Temperature



IAT sensor, or also known as **MAT** (Manifold Air Temperature) sensor measures the temperature of air in the engine inlet manifold. As already mentioned, the maximum number of data of the quantity and density of air entering the engine is required for most accurate calculation of the air-fuel mixture. Today's engines operate under the most ideal proportions of fuel and air mixture in order to meet all legal requirements of the emission of harmful gases, and minimize fuel consumption. Such original engine setting gives oppor-

tunity to enthusiasts and major supporters of the engine performance for **ECU** mappings, which will change the parameters of input and output information in the **ECU**. Of course, with such change of factory setting, the vehicle may not pass the emissions control test.

This sensor is usually placed within the **MAF** sensor or on the inlet manifold. Principle of air temperature sensor is nearly identical to previously described. Sensor receives **5V** voltage from **ECU**. The difference in temperature will change the outgoing voltage value.

KNOCK sensor DETONATION SENSOR



KNOCK (kick, knocking, tapping) sensor is an instrument sensitive to vibration within the engine.

The sensor consists of two ceramic elements, magnets and coils. Vibrating ceramic plates usurps the magnetic field and generates a voltage. Voltage that goes to the **ECU**, will depend on the intensity of vibration of the ceramic ele-

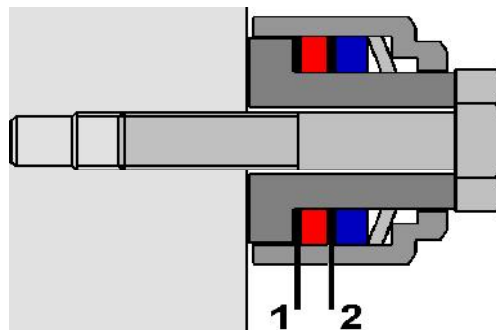

ments, or the volume of knocking sound.

In the drawings we see ceramic elements that affect the seismic mass. Engine vibrations are transmitted to the sensor via a central bolt, by which is a sensor attached to the engine. Voltage oscillation, which ranges from 0 to 5 V, is transferred to shown contacts (1&2) and displayed in **ECU**.

This sensor is mounted on the engine block to prevent damages due to the use of inadequate fuel

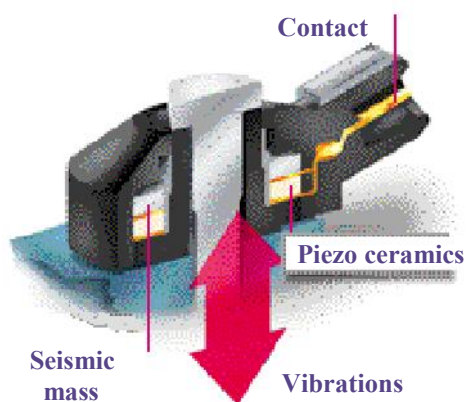

octane value, and to achieve proportional motor performance in relation to the used fuel.

Using lower octane fuel value leads to detonations in the engine cylinders. Such detonations are manifested in the form similar to metal rattling sound. **KNOCK** sensor positioned primarily to capture knocking sound, will send a signal to the **ECU**. Signal strength will depend of produced sounds by detonations in the engine. Based on information received from the **KNOCK** sensor, the **ECU** will adjust the ignition timing to the fuel octane value.

In the following photos we see couple types of sensors, as well as most common position of sensor on the engine.



LAMBDA PROBE O₂ OXYGEN SENSOR



It is hard to say that one of the engine sensors is less important than any other. However, this sensor is certainly one of the most important and integral element of electronic systems in the most basic engine designs.

Lambda sensor or **Oxygen sensor (O₂)** was first appeared on the market in mid seventies and has been developed in the Enterprise car manufacturer Volvo.

The sensor is made of zirconium (**Zr**) ceramics, coated with a thin layer of platinum. The purpose of this sensor is to measure the proportion of oxygen in gases and liquids.

32

Therefore, its use is far broader than the use in car-industry.

In automotive engines, the oxygen sensor is located on the engine exhaust manifold or just in front of the catalyst. Its function is to measure the concentration of oxygen in the engine exhaust gases. By measuring the concentration of oxygen in the exhaust gases, reaches the saturation data of fuel-air mixture. That is, finding out whether the air-fuel mixture is too rich or too poor. Information about the concentration of oxygen in the exhaust gases are sent to the engine **ECU**, which adjusts dispensing fuel.

This drawing shows the most

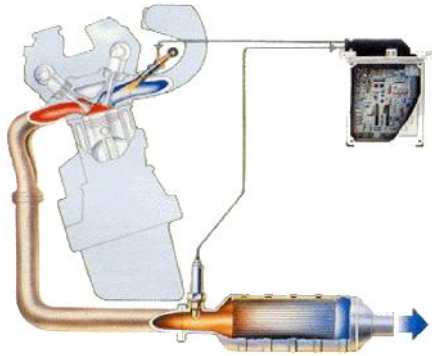

common position of oxygen sensor. It also shows the circle of information from the sensor to the ECU and farther to fuel injectors.

Oxygen sensor is a chemical gen-

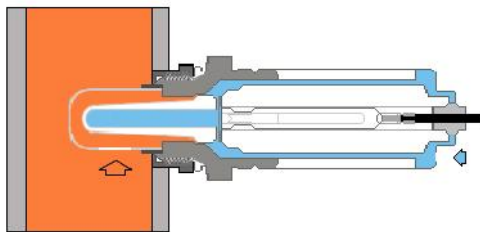

Atmospheric air
 Exhaust gases

erator. As already stated, sensor element is made of ceramic and coated with a thin porous film of platinum from the inside and outside. In the drawings it is evident that the screwed part of the sensor is in the exhaust pipe exposed to exhaust gases,

while the outer part is exposed to atmospheric air. The probe will respond to the difference of oxygen concentration in the exhaust gases and atmospheric air by generating the voltage. The greater the difference is between the concentration of oxygen in the exhaust gases and atmospheric air, the generated voltage is higher. For example, if it is a poor fuel mixture, the concentration of oxygen in the exhaust gases will be high, and generated voltage will be approximately 0.2 V. If the mixture is too rich, the oxygen concentration will be small, and the generated voltage will be approximately 0.8 V. Such voltage fluctuations vary in milliseconds. ECU will, on the basis of received information about the differences in voltage, adjust the fuel mixture correct dosage. With the exact dosage of fuel, the ECU will maintain the average voltage of 0.45 V, which should be the ideal air / fuel ratio 14,7:1.

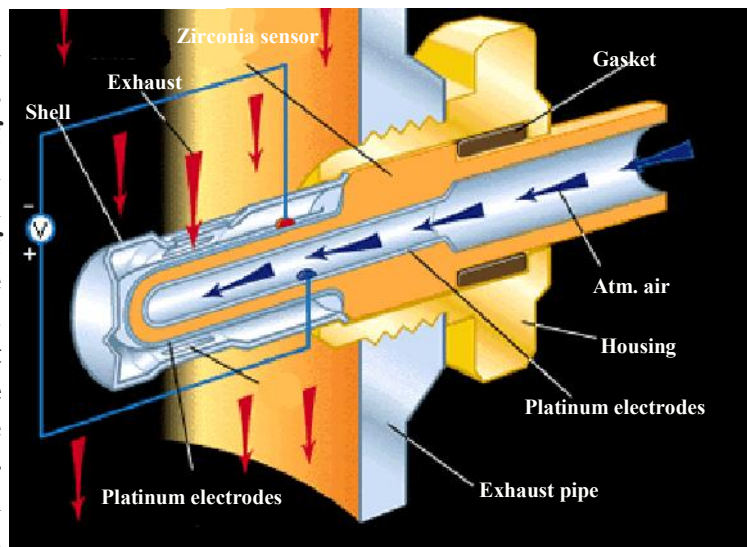

Oxygen sensor is not in operation while the engine is cold. During this time, the ECU will dose fuel by installed program and will take in consideration sensors values like: coolant temperature, air mass etc. Lambda probe will not generate voltage until heated to about 200 ° C, and the proper functioning of the sensor will be possible only at 350 ° C. For that reason, the probe is often placed at the top of the exhaust manifold. Positioned in such way, a probe heats up very quickly and has only one output wire from the sensor. Since the exhaust manifold is firmly tied to the engine, the same is used for ground (-) of lambda probe. In other words, the single output wire from the sensor is signal wire (generated voltage), and body of sensor is a ground, or negative pole.

Due to the different accommodation of O2 sensor in the exhaust system, we will meet up with sensors which have from 1 to 4 wires. Namely, if the sensor is placed on the exhaust pipes away from the engine, the device is equipped with heater. Heater will accelerate warming and thus accelerate its activation. So, the sensor with one wire (usually black) has a closed electrical circuit through the body. Some vehicle manufacturers want to ensure proper electrical circuit of the sensor with installation of two wires, black for signal and grey for ground. Sensors with installed heaters are used, when accommodated away from engine.

Vehicle manufacturers who provided the ground on the exhaust pipe shall incorporate the probe with three wires. Black wire will be the standard for signal and two white are connected to the plus and minus and activate the heater to the required temperature. Last option is four-wire probe. These probes will be incorporated in manufacturer's vehicles who want

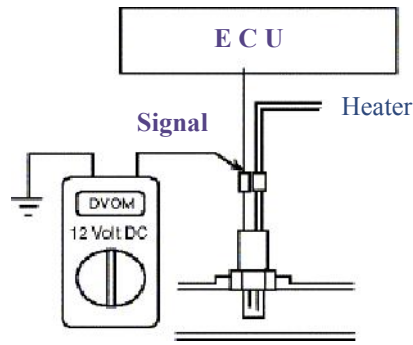

Sensor with three wires



Four-wire sensor

to fully ensure the electrical circuit. In this case, the black will be signal, grey ground and two white sensor heater.

CTS Coolant Temperature Sensor

CTS or ECT (Engine Coolant Temperature) is the sensor measuring the engine coolant temperature.

Coolant temperature sensor is usually placed before the thermostat. This sensor informs the ECU of engine temperature. The engine temperature will dictate the amount of fuel that injectors will inject into the engine. Since the ECU is programmed with engine operating temperature data, the computer will automatically calculate the ratio of fuel and air into the engine on different temperatures for the purpose of obtaining

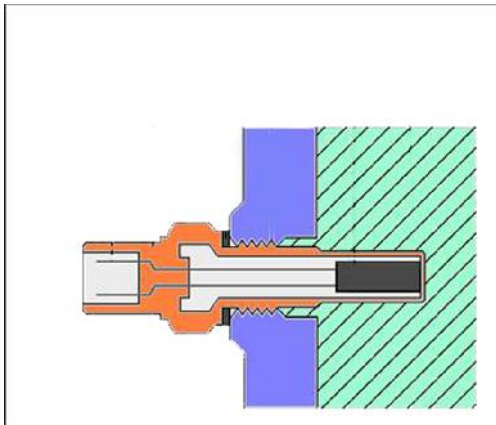

the proper engine operation.

Sensor, screwed in the cylinder head with its lower part immersed in engine coolant, will very accurately monitor its temperature.

Similar to other sensors, through this sensor is flowing 5V voltage. Sensor element immersed in fluid



acts as a resistor. At low temperatures, the resistance in the sensor element will be high, and therefore, the voltage signal to the ECU will be low. Increased temperature reduces the resistance and voltage to the ECU increases. With accurate calibrated sensor, the engine computer will know the precise temperature at any time.

Example:

<i>Temperature</i>	<i>Resistance</i>
0° C	5000 - 6500 Ω
10° C	3350 - 4400 Ω
50° C	700 - 950 Ω
70° C	400 - 500 Ω
90° C	200 - 290 Ω

TPS sensor Throttle Position Sensor



Throttle Position Sensor is located at the end of the butterfly shaft (shown in right photo). The central moving part of the sensor sits on a square or notched end of the shaft. The sensor is designed as a sliding potentiometer and with variable resistance in various positions decreases or increases the voltage to the ECU. As in previous cases, ECU powers this sensor with 5V voltage. In the closed position, the sensor resistance will be



the highest, and the voltage to the **ECU** the lowest. When butterfly openness completely, or how we usually say, full throttle, the resistance will be minimized and the value of the output voltage will be

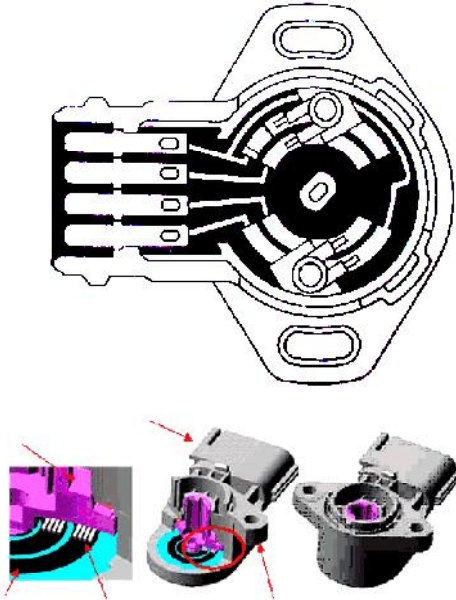

the highest 5V.

In practice, we may see different types of sensors, with two-or more connections. However, in principle, all work the same way. The central part of the rotating sensor is connected to the butterfly shaft. By opening the butterfly pivot turns, and with it the sensor central part. Brush attached to the mobile part of sensor is sliding over the contact surfaces of the static part of sensor and increases or decreases resistance.

TPS sensor is also one of the indicators to the **ECU**, for adjusting fuel dosage and ignition timing.

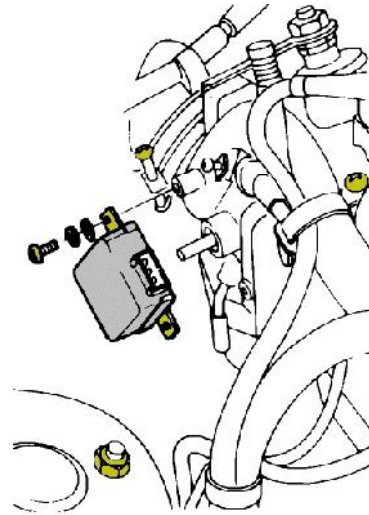

Position of throttle butterfly is one more information, which will, in comparison with data of engine **RPM**, airflow and others, determine the precise ratio of fuel and air mixture and ignition timing.

This sensor is extremely important for the rapid acceleration of the vehicle. The sudden pressure on the accelerator **ECU** will record as discrepancy of engine **RPM**, quantity-pressure of air intake and throttle position, and add the required amount of fuel in order to avoid sudden loss of power and allow immediate acceleration.



OBD

On Board Diagnostics

VEHICLE DIAGNOSTICS



On Board Diagnostics, or OBD, in the context of the automotive means possibility of self diagnosing faults on vehicles, as well as access to stored encoded errors. This option allows the vehicle owner and the service quick insight into the condition of the engine management and other systems on the vehicle, and failure diagnosis without the use of very expensive diagnostic equipment made for only certain types of vehicles.

The quantity and quality of information available from the On Board computer in the vehicle (control units in vehicles), signifi-

cantly increases from year to year since the early '80s when OBD began to be implemented in cars.

Early OBD systems have provided very little information about the error occurred on the engine. In case of failure, most would just light lit "Check Engine", with no possibility of reading errors or focus on a particular component of the vehicle. In such cases, the owner of the vehicle was forced to take a vehicle into a specialized service, which possessed adequate diagnostics for fault finding. Modern OBD systems use a standardized digital ports allowing quick

access to a wide range of information from control units (computers in cars). Information about the failures is expressed in standardized codes, which accurately indicate the faulty component of the vehicle and suggest next steps to solve the problem.

To be able to establish communication between computers in a vehicle and an external computer which reads the data, we use interface. That's the way we establish communication with the vehicle, and it consists of an electronic assembly, cables and connectors.

To provide for everyone, all over the world, access to **OBD** informa-



tion, the **INTERFACE** standards are set. In the early days of **OBD**, it was quite a lot of problems with standards because there were several types of connectors depending of vehicle type and year of manufacture.

ALCL (Assembly Line Communications Link) standard, later renamed to **ALDL** (Assembly Line Diagnostic Link) have been highly impractical, because of differences

in communication between the specifications of different vehicle models. For this reason, diagnostic devices were mostly owned by specialized workshops for certain vehicles.



In previous images are shown just some examples of **OBD** connectors. However, it is enough to see the impracticality of different standards when trying to diagnose fault. Of course, these differences in connectors are not accidental. This way, manufacturers are forcing vehicle owners to service their vehicles by authorized services.

The connectors we see have a dif-

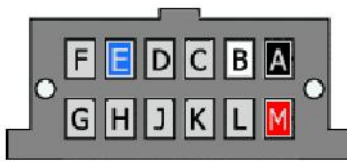

ferent number of pins (contacts). The number of pins depends of the amount of data that can be obtained from the complete vehicle. Beside the engine management diagnosis, through these connectors we can control and other systems: **AC**, **ABS**, etc. But for basic diagnostics, only three pins are needed. One for the ground, the other one for plus terminal and the third one for signal. Therefore, the connectors with three pins are often found on older middle-class vehicles.

In order to improve the situation of gases emissions from motor vehicles, in the late 80's began to apply the **OBD-I** diagnostics system. As the auto industry had to adapt to larger and more stringent environmental requirements and laws, the **OBD-1,5** diagnostic system

were applied on vehicles. It was the forerunner of **OBD-II** system, and hybrid of **OBD I** and **OBD-II** diagnostics. On this system **OBD-II** 16-pin connector was used, but the **OBD-I** code reader. This system was used for very short period (94-96), until **OBD-II** diagnostics system took its place. Repairers who are not familiar with this penultimate variant of diagnosis, will often feel confused finding **OBD-II** connector on the vehicle and not recognizing the car computer with **OBD-II** diagnostic program.



OBD-II 16-pin connector

OBD II diagnostic system is legally required on vehicles in the U.S. since 1996. year. In Europe, vehicles with petrol engines are equipped with **OBD II** since 2001, and vehicles with diesel engines since 2003. year. Unlike previous systems, **OBD II** is maximally standardized. In all vehicles are built standardized 16-pin sockets. In previous diagnostic systems, various outlets are located both ways: inside the vehicle and at various positions under the hood. **OBD II** socket is exclusively located inside the vehicle with maximum distance of 90 cm from the driver.



In the above photos, a few positions of **OBD II** socket inside the vehicle are shown. As we see, the sockets are set up for quick and easy access. Locations of connectors for the individual vehicles are shown schematically in all Auto data, which are used when servicing vehicles. But if we do not dis-

pose of such literature or software, sockets can be easily found. Namely, **OBD II** connectors are typically located on the lower side of dashboard and can be visible or covered with plastic lids. Less frequently these sockets are located in the center console, next to the handbrake or in the ashtray space.

OBD II diagnostics system has five communication protocols, which allow us to communicate with the vehicle computers. Protocol is a standardized method of communication. The protocols have changed over the years, and varied from different vehicle manufacturers. Thus we come across different protocols from the U.S. and Europe to Asia. Because of differences in protocols, technician must know which protocol has to be used to access data from certain vehicle models, and so choose the appropriate scanner (interface). Today only specialized services are using scanners with one or two protocols, while the universal service personnel trying to obtain a multiprotocol scanner. Of course it is advisable for such repairers to obtain multiprotocol scanner, which will enable smooth communication with all types of vehicles.

The protocols differ in the use of pins (contacts) on the connectors. As noted previously, the primary diagnosis needs only three pins. However, each of the five protocols does not use the same pins, and for this reason we can not communicate with computers without a compatible car scanner.

OBD II protocols:

1. **J 1850 PWM**
2. **J 1850 VPW**
3. **ISO 9141-2**
4. **ISO 14230-4 (KWP2000)**
5. **ISO 15765-4 (CAN)**

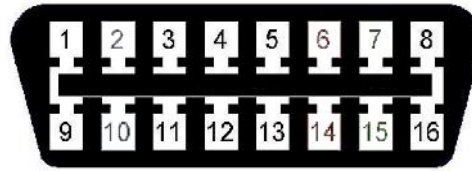

OBD II 16-pin connector is designated by the numbers (in sketch only). The next few examples are showing how certain protocols are connected to the socket contacts.

PWM protocol uses the contact 2 and 10 for signal, while the contact 5 is ground and 16 power.

VPW protocol uses the contact 2 for signal, 5 for ground and 16 for power.

ISO and KWP protocols, using the contact 7 and sometimes 15 for a signal, 5 for the ground and 16 for power.

CAN protocol, uses the contact 6 and 14 for signal 5 for ground and 16 for power.

With **OBD II** diagnostics is possible to do a complete test of engine and power train electronic components, and with some programs even more. Even just the basic programs can read the value of each sensor when engine is running. Beside monitoring the engine **RPM**, the program reads **MAF** and **MAP** sensors data, air and coolant temperature and monitoring engine voltage oscillations on lambda probe and control probe or **O2** sensors.

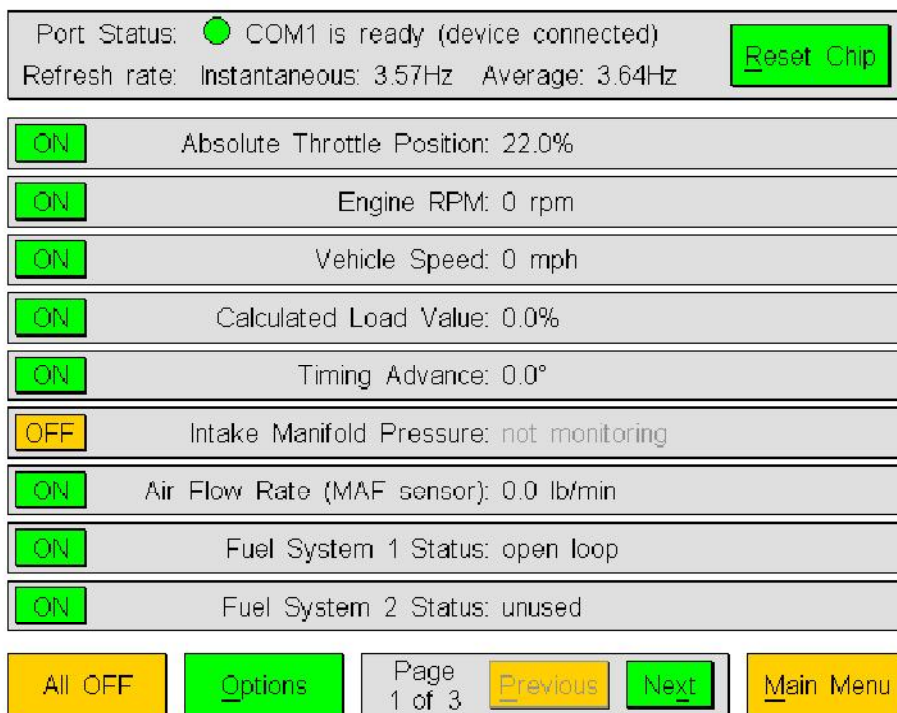

This are two examples of a basic programs, which give us a chance to read the value of each sensor at different engine RPM. Identical test can be done, and while driving, if we use a laptop computer.

mation about the vehicle which we are testing, these programs will be ideal for comparison of defined values for the individual sensors and read values.



Every basic program, besides reading sensor values, has the possibility of reading a **DTC (Diagnostic Trouble Code)**, or code labeled errors, which are stored in the **ECU**. If there is error in any element of engine management, the engine computer will register a malfunction in the form of codes. **DTC** is made up of letters and numbers. Error codes are divided into generic or general codes and codes of vehicle manufacturers. Explanations of generic codes are usually an integral part of the program we use, while the manufacturer codes can be found in the li-

If we have the technical infor-

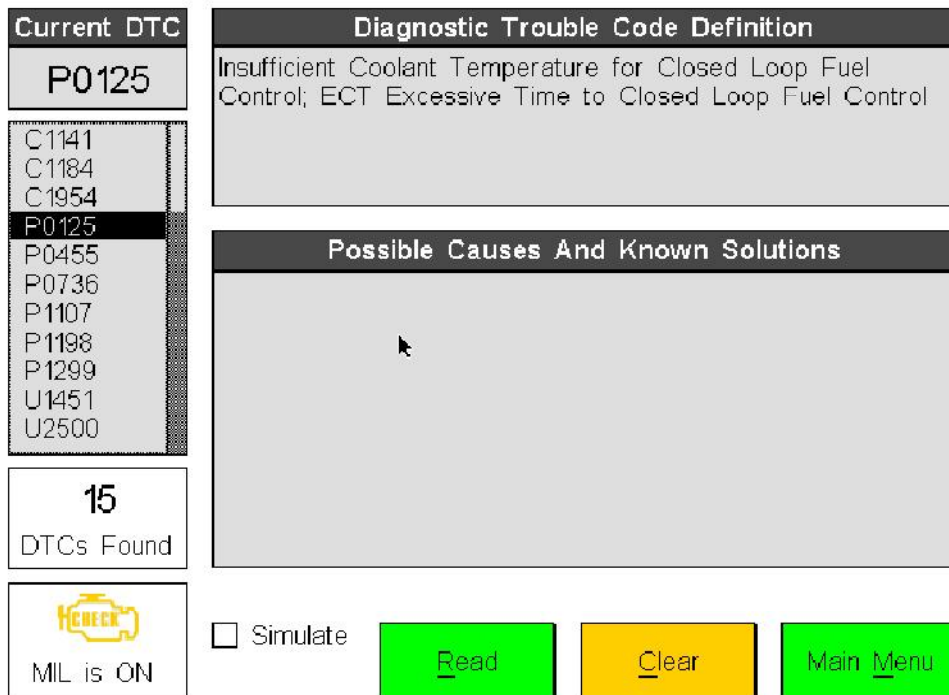

terature of the vehicle manufacturers or find the help on the Internet. Substantial number of vehicle manufacturer's **DTC** can be found in commercial programs, such as Auto data etc.

The figure above shows the option of reading a **DTC**. By clicking on Read, on the left side of this option will appear **DTC** (if any), and on the right side its explanation. In this case it is a generic code, and its explanation is stored in the program. If it was a vehicle manufacturer's **DTC**, just code number will appear, without explanation. Generic codes can be easily identified, because they always begin with a zero after the initial letter.

As explanations of generic codes are offered in diagnostic programs itself, there is no need to know the

meaning of code letters and numbers. But when it comes to vehicle manufacturer's codes and we have no explanation, we certainly need to know the meaning of letters and numbers, to keep us focused in the direction of failure. Therefore, this table which explains the meaning of letters and numbers will come handy at a time. The explanation is for the written letter or number, and (x) mark stands for filling other code particulars.

- Pxxxx** Engine and transmission
- Bxxxx** Body
- Cxxxx** Chassis
- Uxxxx** Other systems
- P0xxx** Generic Codes
- P1xxx** Manufacturers Codes
- Px1xx** Fuel mixture

Px2xx Fuel mixture
Px3xx Ignition
Px4xx Emissions
Px5xx Idling control
Px6xx Computer
Px7xx Transmission
Px8xx Transmission
Px8xx Modules

Explanations for generic codes, which have booked zero after the initial letters, have to be legally available. Namely, these codes are closely related to emissions. In other words, easy and quick access to the meaning of the code memorized in the ECU will allow quick car repair to any workshop and regulate the proper emissions.

Certainly, this method of diagnosis is great help for mechanics and engineers. However, just reading DTC will not always lead us precisely to the existing problem. DTC focuses on the electronic element of the vehicle, but its explanation does not specify a particular action, such as changing the element. For example, DTC P0017 will focus us on the CKP sensor, but does not suggest that we change it. In code explanation, they will say that the problem may be related to the installation of CKP, or mechanical damage. This means that the service must have a good deal of knowledge about car electronics, in order to examine the installation, check the mechanical damage and examine the sensor in one of the ways previously described. Only after such checking conclusion can be drawn whether problem lies in faulty sen-

sor and should it be replaced with a new one.

It often happens when testing the engine that we read the parameters with perfect values, but having stored DTC in ECU. In such cases, it is possible to erase the DTC from ECU memory. However, after deleting the code, it is necessary to drive the car for a while and see if the DTC reappears. Namely, it is possible that DTC occurs due to trivial errors, which have emerged and are then disappeared. Computer has registered the problem, but it will not delete it, even though it does not longer exist.

The following basic option of this program shows how to delete codes from the ECU. This option also allows turning off the MIL (Malfunction Indicator Lamp), or signal light, which warns about malfunction of some engine electronic element. The same light is also known as "Check Engine". Clicking on the Clear option, the display will show a warning, which verifies the mechanic readiness to clear the stored codes and turning the MIL off. In fact, it sometimes happens that DTC is deleted from the ECU memory without having previously solved the problem. Of course, if there is a malfunction, the vehicle is often necessary to drive for several miles in different driving conditions, so that the error appears again. So, deleting the DTC from the computer memory should be left to the very end of the service procedure.

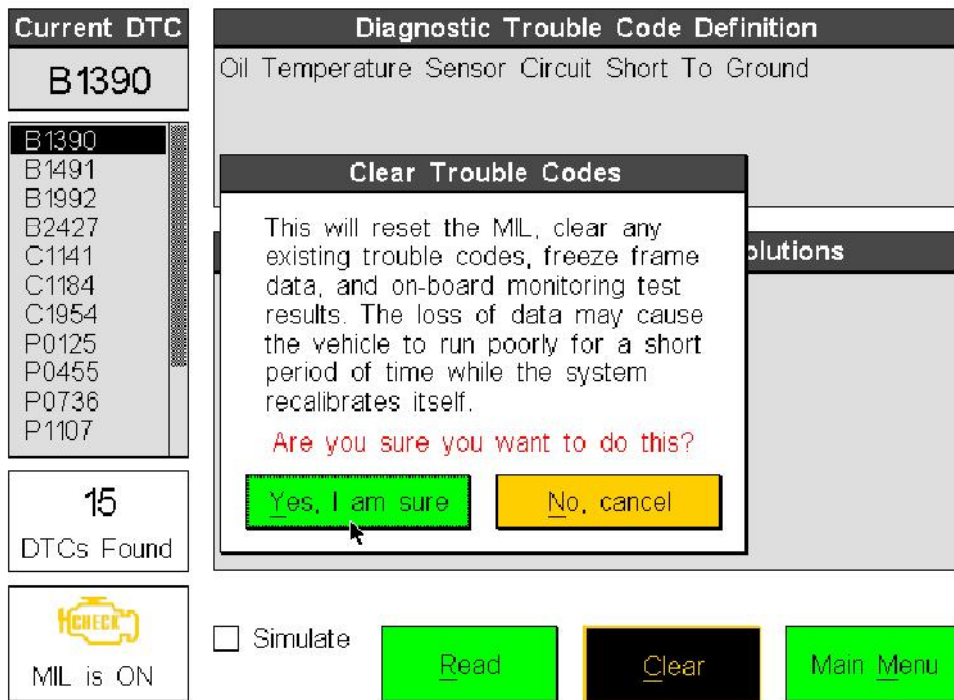

In the above figure we see displayed DTC's, their explanations and deleting possibilities. In this example, fifteen DTC's are present (slightly exaggerated). Usually we find one to two cached codes. On the right side we see an explanation of the code (if it exists in the program). So in this situation we find that the engine oil temperature sensor is shorted to ground. Since it is a sensor resistor, it can be checked before replacement. Based on the obtained diagnose by the above code, the resistance between two terminals on the sensor should be zero. In the lower left corner shows the MIL or Check Engine light, which is in this case turned on as the DTC's are detected.

Beside these basic diagnostic programs, which generally meet all needs of diagnosing engine failures, there are many more commercial programs on market which offer far more features. So in the picture below we see the values monitoring with the oscilloscope. It is also possible to measure the vehicle acceleration, power and engine torque.

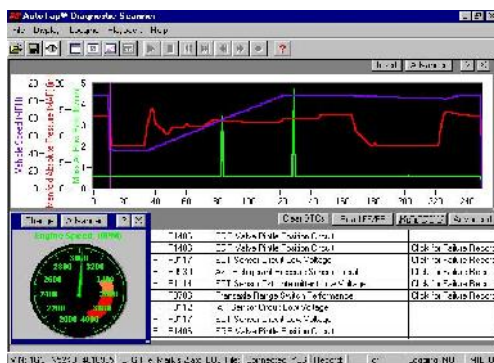

ISC

Idle Speed Control

ACTUATOR

Actuators are the next important elements of engine management.

Unlike the engine sensors, which send information to the ECU, actuators receive commands from the ECU and do some work. One of them is the ISC actuator.

ISCV (Idle Speed Control Valve), regulates the air pass aside the throttle butterfly on the engine inlet manifold. This control valve is essential for proper regulation of the engine RPM at idle. ECU regulates the valve opening and closing on the basis of data obtained from the engine sensors. In this case, the

CKP sensor will transmit data of engine RPM to the ECU, which will control the valve to maintain a constant programmed engine RPM. Surely, the engine could operate without this regulator, but only at programmed RPM in the idle throttle. However, this RPM would vary the same way as it does on the engine with carburetor, depends of engine load. Namely, using lights and other electrical consumers on the vehicle, alternator will load the engine, in which case the idle RPM will be reduced. However, ECU registers the drop

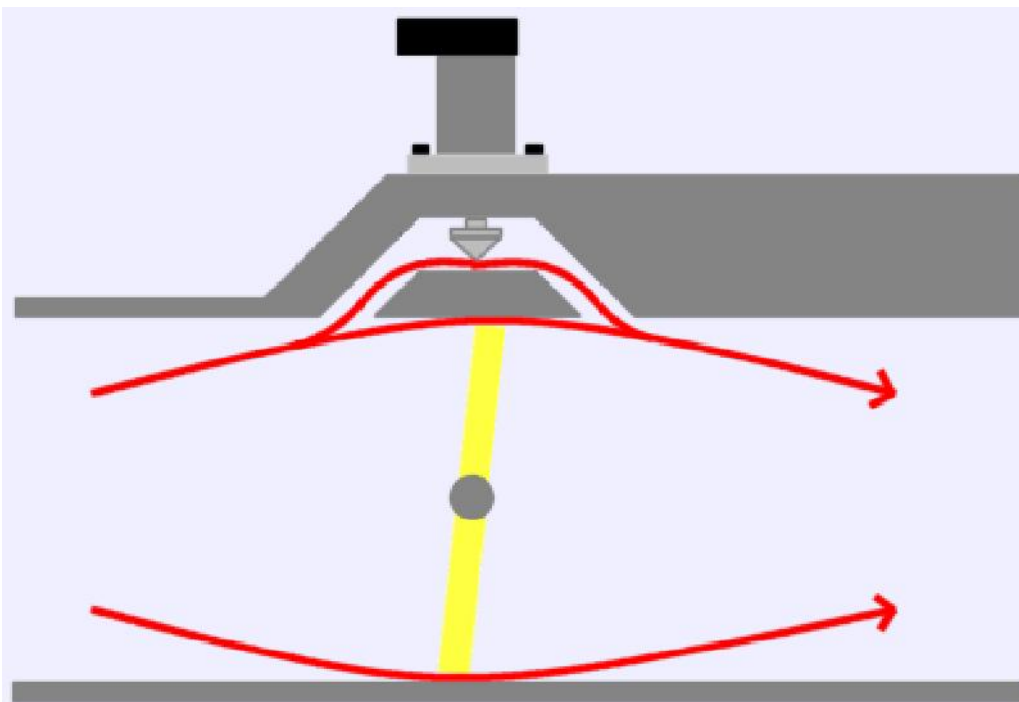

of **RPM** and automatically regulates the valve to increase **RPM** as defined. The same situation will occur when switching on air conditioning, engine radiator cooling fan etc. This control valve is immensely useful on vehicles with automatic transmission, where will avoid unpleasant twitches when shifting into gear, what was the case on cars with carburetors. Of course the **ECU** uses this valve to increase the **RPM** during cold engine operation.

On today's cars we will find several types of control valves. However, they all function the same way, regulating air flow through throttle by-pass. The lower photo shows one of the most common valves in today's vehicles. It is also known as the step motor. This

valve operates on the principle of two-way electro-motor, which when needed turns to the left, or right. Valve shaft has a thread cut on it and twisted in the rotor. By turning the rotor to the left or right side, the valve shaft will be raised or lowered, and thus regulate the amount of air flow.

Another type of valve, shown in the following drawing and photo, works on the principle of the solenoid. The power of electromagnetic fields will withdraw the valve shaft more or less, and close or open channels for air flow to regulate its volume. In first and the second case, the **ECU** is the one who gives orders of the air flow amount.

In the first case, the poles will change and rotate the motor to the



left or right, to maintain the required amount of air intake. In the second case, the ECU will reduce or increase the voltage at the solenoids and thus increase or decrease the strength of electromagnetic fields. The power of the electromagnetic field will determine the openness of the valve and thereby ensure the proper flow of air in order to maintain continuous programmed engine RPM.

The most common problem which causes erratic idling is carbon deposit inside the valve and throttle caused by the engine breather. This deposit will not always allow proper closing of the butterfly throttle, and there will be fluctuations in engine RPM. Therefore, before making a conclusion about defective valve, it is advisable to check if there is any carbon deposit inside the valve or around and on the throttle butter-

fly. After cleaning the valve and throttle housing, the smoothness and completeness of valve and throttle butterfly openings and closing, have to be checked.

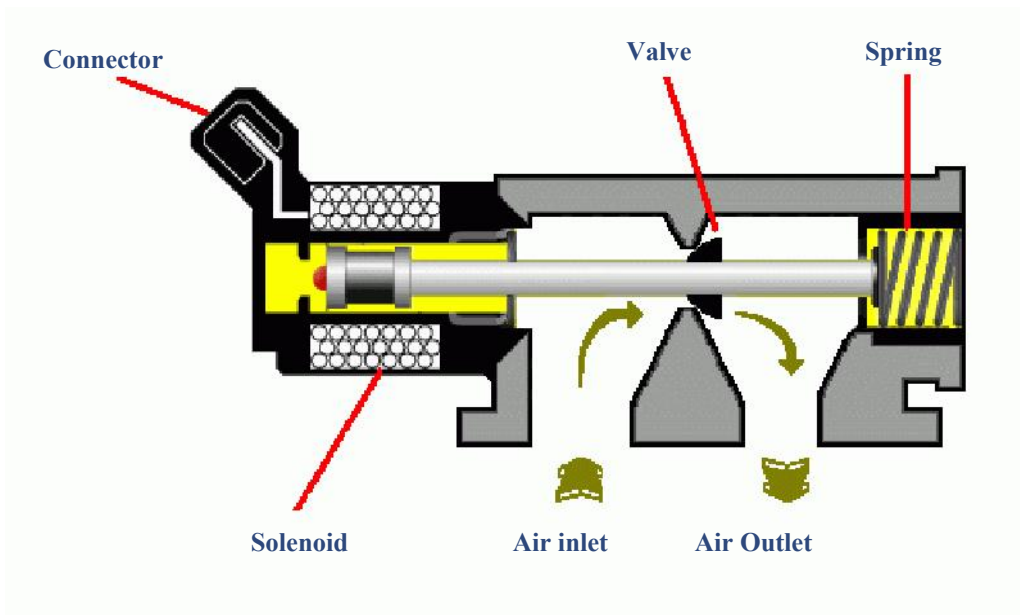

EGR

Exhaust Gas Recirculation

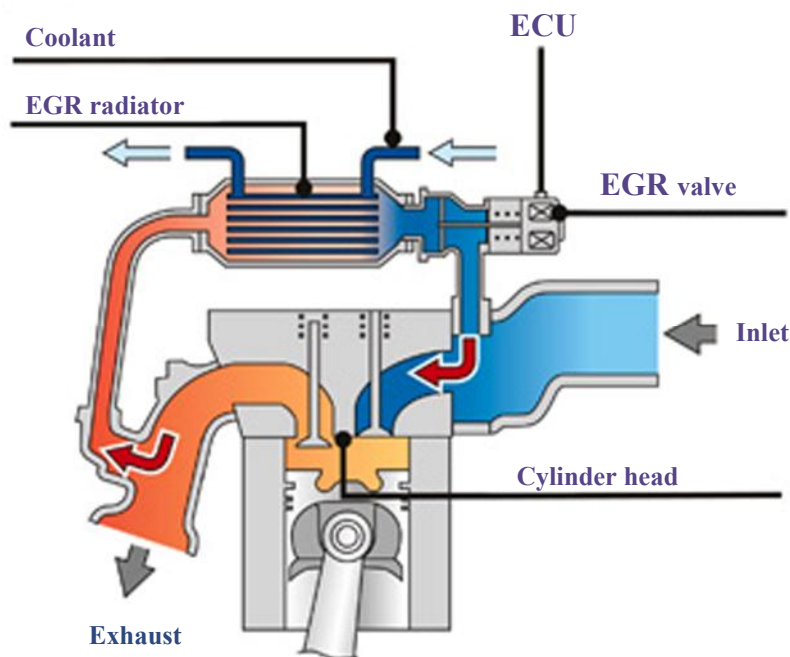

Exhaust gas recirculation (EGR) is the reduction techniques of **NO_x** (nitrogen oxide and dioxide) gases in most vehicles with gasoline and diesel engines.

EGR system operates on the principle of recirculation of exhaust gases. Returning an amount of exhaust gases into the engine intake manifold, intake gas mixture is diluted with inert gases from the exhaust and thus reduces the mixture burning temperature, on which the **NO_x** is formed in the largest quantities.

In older vehicle models, the **EGR** valve in gasoline engines is controlled by vacuum. Such regulation of valve opening and closing

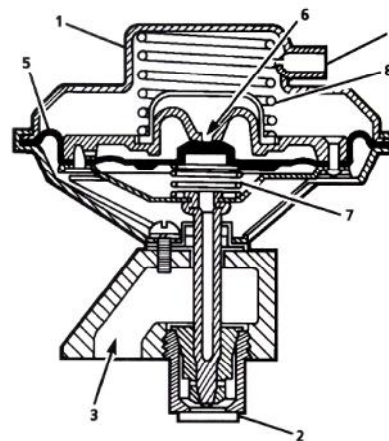

- 1. EGR valve
- 2. Exhaust
- 3. Inlet
- 4. Vacuum

- 5. Diaphragm
- 6. Breather
- 7. Spring
- 8. Spring

was quite inaccurate and this was reflected on the engine performances. Today we can also find vacu-



um EGR valves, but the vacuum regulation is done via solenoid, which is managed by the ECU.

In today's vehicles, electromagnetic valves or step motors are commonly used. These valves are very precise and directly controlled by engine computer. The right drawing shows the schematic representation of an electromagnetic valve, which opens and closes the channel with electromagnetic field strength. In the first sketch we can see how the exhaust gases are cooled in some cases, before entering the engine intake manifold.

The amount of exhaust gasses that mix with the intake mixture in petrol engines ranges from 5 to 15 percent, while in diesel engines it is up to 50 percent. The entry of exhaust gases into the intake manifold is allowed only when car is continuously driven and the engine

is medium-loaded. The valve is closed at engine idling, the acceleration and load, due to the need for greater engine power. In addition to using this system in order to suppress the emission of harmful gases, it contributes to a considerable saving of fuel at a moderate speed.

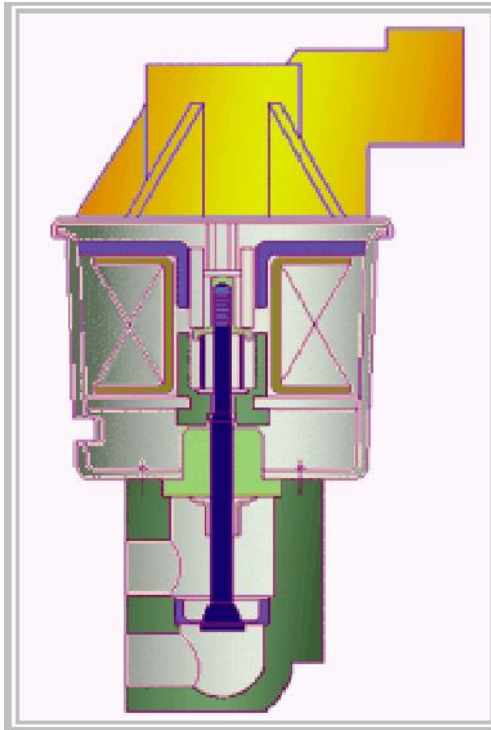

VTEC Variable valve Timing and lift Electronic Control

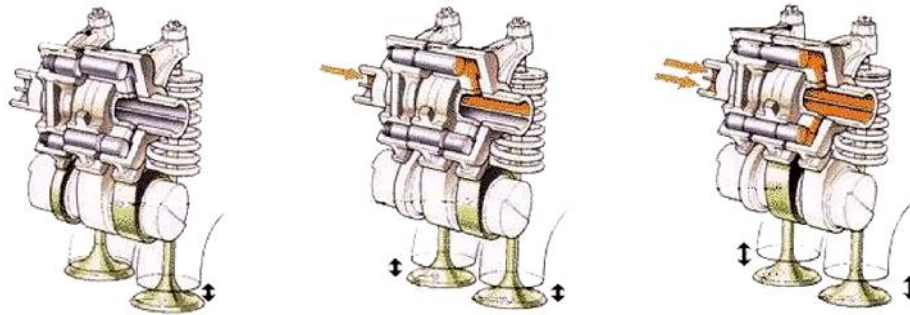

Variable camshaft uses two hills of various heights and curvature, which allows the suction of greater or lesser amounts of air-fuel mixture. Moment of involvement of one or the other cams determines the **ECU** based on data from sensors about the engine **RPM** and other parameters. Blocking valve rocker on one of the cams is carried out by electro-hydraulic system.

Engine oil pressure, which moves the rocker blocking shaft, is controlled by solenoid valve, controlled by the **ECU**. Allowing the oil under the pressure enter into the rocker blocking system, the oil will push the pin into the desired blocking position.

VTEC is solution to construct high-performance engine, which will simultaneously be able to meet the demands of city driving and moderate fuel consumption. Namely, high-performance engines have very high hills on the camshafts, due to a larger volume of air-fuel mixture intake. For same purpose, the curvature of the hills

are much larger than on standard camshafts. Greater curvature of the hills provides a long time valve opening, and thus greater intake volume of air-fuel mixture. But such a solution will be unfavourable working condition under a lower speed. Firstly, the engine uses not needed power, Secondly, fuel consumption is increased and engine idle is very rough and uneven.

By using variable camshaft with different cam profiles, high performances will be achieved at high revs, but at low speeds and idle the engine will run very sparingly with a sufficient volume of mixture for such driving conditions.

During development of this technology, manufacturers have developed several systems. In fact, the easiest part of this system is the last stage, where the highest cam is used for the greatest benefits of maximum performance achievement. However, at lower revs, manufacturers are trying to achieve the lowest fuel consumption. For example, in some models of engi-

nes, at low revs only one intake valve will open, at medium revs two and at high revs valve timing will shift to the highest degree.

In the first sketch we see a VTEC model, where the first stage opens only one intake valve, while other is only partially opened. In the second instance, the rocker shaft blocked both valves, which are raised with medium height cam. And in the third degree, rockers are blocked in such way that they are both lifted with highest cam.

On the lower sketch we see simplified view of a mechanical rocker lock. In the first phase, two extreme rockers are opening both valves at the lower hills. In the second phase, the valves are closed, and axle blocks all three rockers. In the end, blocked rockers are lifted with the highest cam.

On the following sketches, the same principle of rocker blocking is performed by pressurised engine oil. Engine oil is marked with A

letter. Under the pressure oil will push the two axes through the channel and thus block the rockers, making them one assembly.

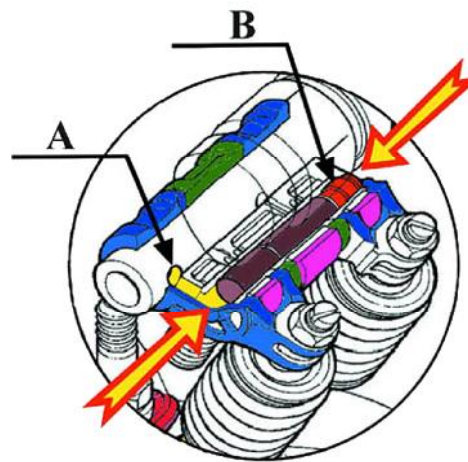

When the solenoid valve closes the supply of pressurised oil, spring marked with the letter B will return the shaft to the rocker, and they will become independent. Going back to the first sketch, we see that blocking shafts are mounted on the upper and lower side of the rocker. In combination, placing

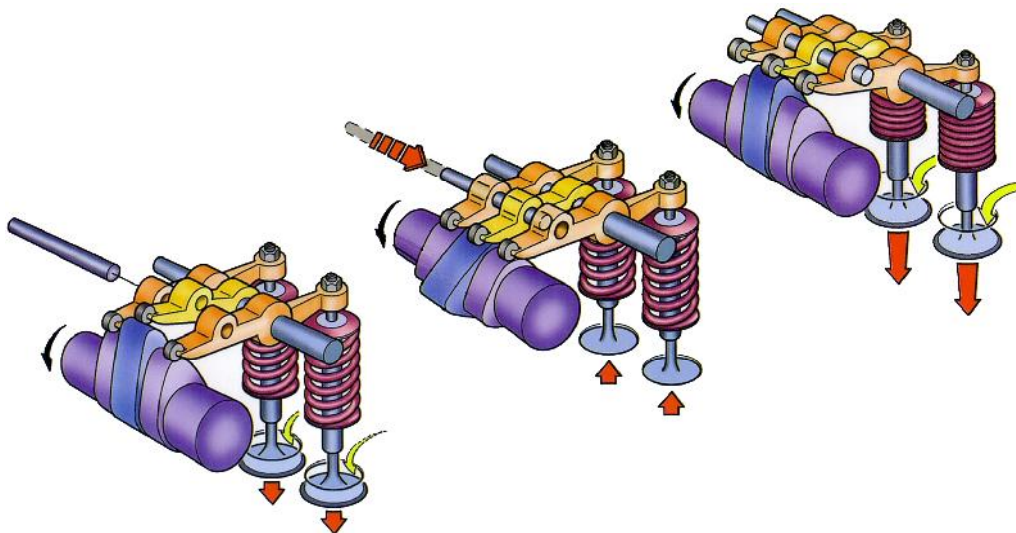

shafts and springs of different resistance will allow blocking rockers on request at a given engine oil pressure.

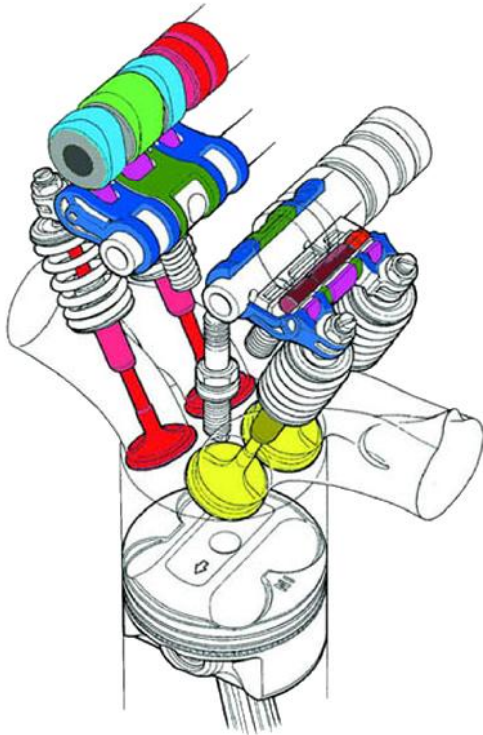

More advanced variant of the variable camshaft is known as the (intelligent) **i-VTEC**. This system was further advanced than the previous concerning fuel economy and reduced emissions. At low **RPM**, a valve opens only partially, as already stated. However, this valve will close a little later than it was predicted in the intake stroke. So, it will be the moment when the mixture returns back into the intake manifold. This camshaft is also called the economical camshaft.

In addition to economical camshafts, intelligent **VTEC** has the ability to adjust the opening angle

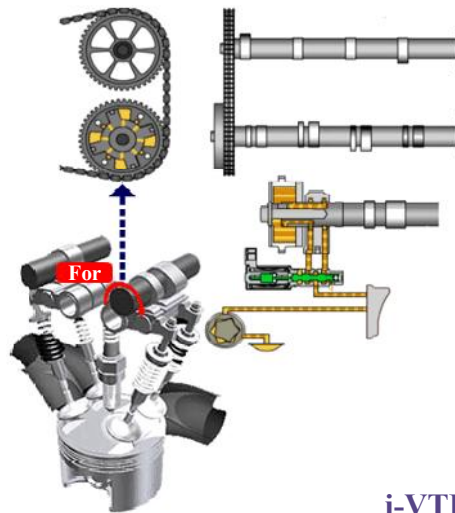

i-VTEC

of intake valves. By adjusting the valve opening angle (later opening) maximum fuel economy and very quiet engine running at idle is achieved. By adjusting the angle for early intake valve opening, maximum engine performance at higher revs is achieved. Adjustment of the valve angle is achieved by rotating the inlet camshaft forward or backward. Camshaft rotation again sets the **ECU**, taking in consideration the parameters obtained from the engine sensors. In this case too, camshaft is rotated by oil pressure and electromagnetic valve managed by **ECU**.



Catalytic Converter

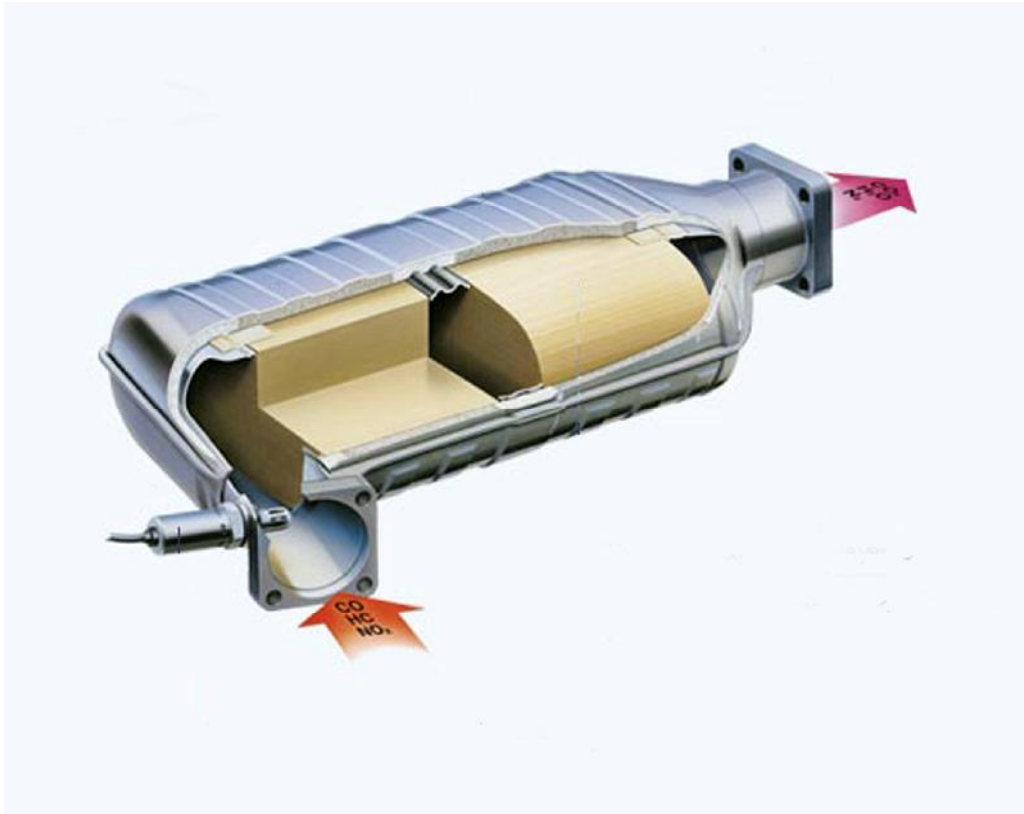

The catalyst is not exactly an electronic vehicle element, but it is a chemical converter and an integral part of today's cars. Since it is closely related to the engine and its electronics, it is inevitable to explain its function in this book.

The role of catalyst is the reduction of hazardous emissions from petrol and diesel engines. As a product of air-fuel mixture combustion, a dangerous and harmful gases are created: **CO** carbon monoxide, **HC** hydrocarbons and **NO** and **NO₂** nitrogen monoxide and dioxide, together termed **NO_x**.

These are the three most dangerous and most harmful gasses, which are subject to legal regulations of vehicles emissions, a catalyst is incorporated for their reduction.

A newer generation of cars is mainly equipped with the so-called "**Three-Way**" (triple) catalysts. This term refers to the reduction of these gases molecules: **CO**, **HC** and **NO_x**.

As can be seen on the upper drawing, the catalyst is divided into two parts, and consists of two ceramic elements. First is called reduction and second oxidizing

element. Both elements have a ceramic or metal structure coated with precious metals which have the catalysts properties: **platinum**, **rhodium** and **palladium**.

The biggest problem in catalyst designing was constructing the

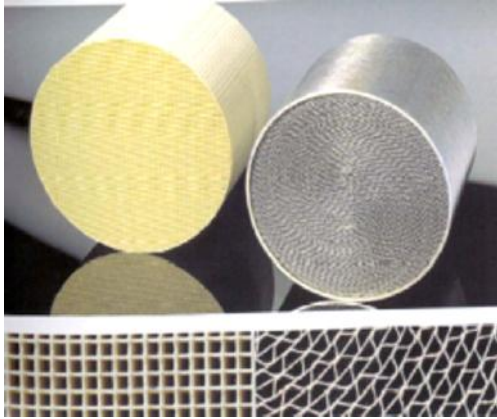

Ceramic and metal structures

maximum surface structure, which will come into contact with the exhaust gases. Of course, it was necessary to take into account the minimum quantity of catalyst material, as it is costly.

As mentioned, the first part of catalyst is called the reduction element and is covered with a thin layer of platinum and rhodium to reduce emissions of **NO_x**. When the **NO_x** gases come in contact with the first part of the catalyst, it separates the nitrogen atom from **NO** and **NO₂** molecules and retains it. At the same time releases the oxygen atoms, which pass through the catalyst in its second part. The second element or oxidation catalyst reduces unburned hydrocarbon **HC** and **CO** carbon monoxide. These gases reduce in

combustion and oxidation process when they come in contact with the catalyst, which is in this case a thin layer of **platinum** and **palladium**. This catalyst helps the chemical reaction of carbon monoxide **CO** and hydrocarbons **HC** with oxygen in the exhaust gases and oxygen released from the **NO_x** in the first part of the catalyst. By binding of carbon monoxide with oxygen, results in carbon dioxide **CO₂**. Binding hydrocarbons **HC** with oxygen, results in carbon dioxide **CO₂** and water **H₂O**. Diesel engines are mostly built with the catalyst oxidation section only.

The catalyst is usually found located at the front of the exhaust system under the vehicle.

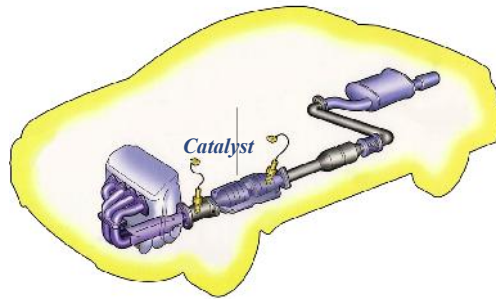

A typical sample of the catalyst

However, lately, the catalysts on all vehicles are moved more towards the engine. Namely, the catalyst does not function until it warms up to approximately 200 ° C. It is the only reason why we come today to specific forms of catalysts in inaccessible places at the engine exhaust manifold (picture below), just with the aim of achieving faster catalyst temperature.



Catalysts are designed to last as long as the vehicle. However, it is rarely the case. Therefore, manufacturers provide a catalyst lifetime of up to about fifty thousand miles, but it is not the rule. Catalysts with a ceramic structure, suffer the most due to shocks caused by running over the bumps on the roads, etc. Another cause is the improper operation of the engine, causing overheating and cracking of ceramic catalysts structure. In such cases, the catalyst will continue to operate at least partially, but will cause irritating sound of rattling stones in an empty pot; decomposition into smaller chunks can cause obstruction of exhaust

gases flow from the engine. Since the catalyst does not function before it reaches proper temperature, the problem of frequent clogging with unburned fuel may occur. The engine, which does not burn properly for whatever reason, will emit unburned mixture from the cylinders, which will be deposited in the channels of the catalyst and cause clogging. Such phenomena mostly happen in diesel engines. This problem can sometimes be solved by driving the longer distance with no load, in which case the sludge will be incinerated, and gas flow enabled again.

In gasoline engines must be used only unleaded petrol. The reason for this is the deposition of lead deposits in the catalyst.

Namely, lead is deposited on the walls of the catalyst and will cause clogging of channels. Purification of channels with accumulated lead is not possible, due to high melting point of lead. Such blocked catalysts, simply have to be replaced.



Partially and completely blocked

FOUR STROKE OTTO AND DIESEL - ENGINES

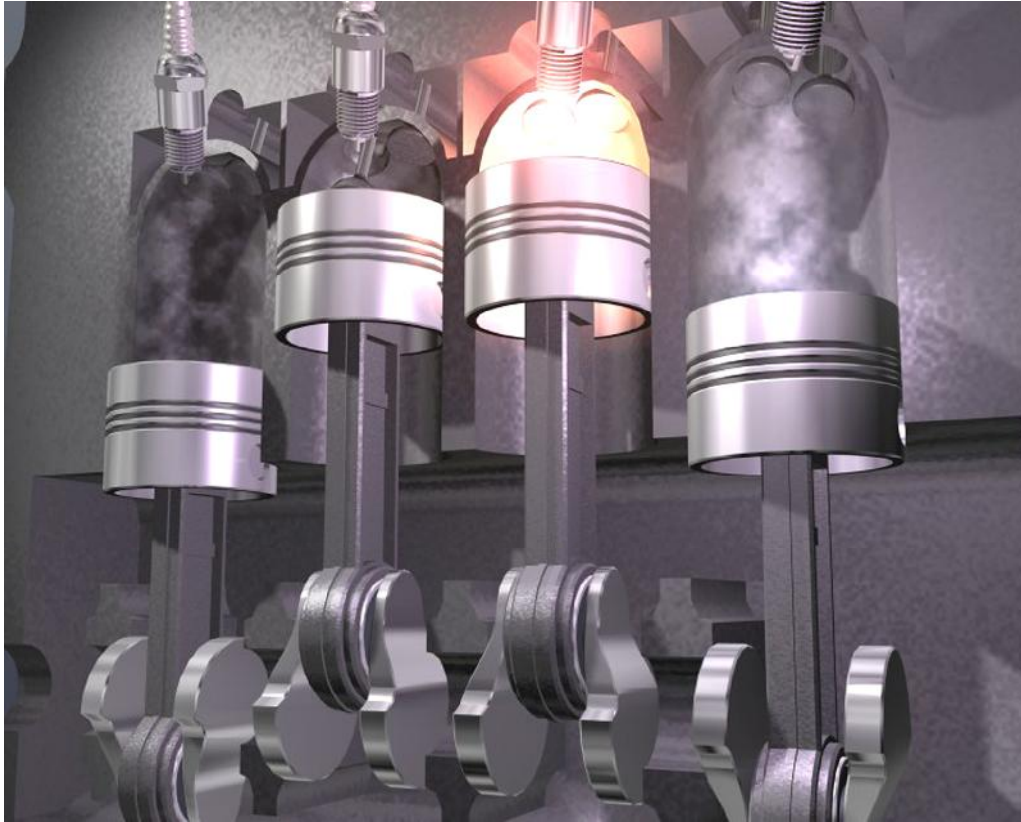

Having in mind that this book is also intended for those who are engaged in automotive as a hobby, the next few pages will be discussed on the basis of **four-stroke** engine. The concept of the previous text is generally comprehensible to those who have good knowledge and experience in the maintenance of motor vehicles. However, those whose knowledge of automotive is poor, will find difficulties to follow this book. This category of readers is targeted in this part of the book, to help them understand the fundamentals of **four-stroke engines**

technology.



In the previous section we can see a sketch of a modern four-stroke **Otto-engine** (petrol engine with two overhead camshafts). Such engines are usually marked as "**DOHC**" what stands for "**Double Overhead Camshaft**" or two camshafts on the cylinder head. This section shows only one engine cylinder, but it applies to all

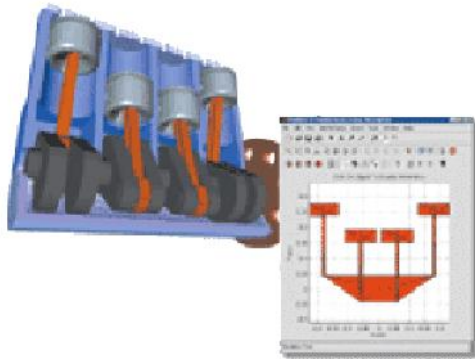

cylinders in the engine. The upper sketch shows the cross section of the entire four-cylinder engine. It can be seen that the crank lobes over which piston rods revolve are positioned opposite (180°) from one another in relation to the axis of the crankshaft. So, on four-cylinder engine, when the first and fourth pistons are at the **TDC (top dead center)**, the second and third pistons are at **BDC (bottom dead center)**. In this concept, the engine will have firing order **1-3-4-2**. This means that the air-fuel mixture in the cylinders will be ignited by this order moving with a mixture inflammation at the end of compression stroke from the first cylinder to the third, then the second and finally to the fourth. This order is constant during the engine opera-

tion. This ignition order dictates camshaft with exact lobe positions for each cylinder, and ignition distributor which distributes the spark plugs at a specific time (in newer vehicles **ECU "Engine Control Unit"**, or commonly known, the engine computer). But, let's get back to the first sketch of a single cylinder. On the cylinder head we see two camshafts and its lobes, which are associated with the engine crankshaft by toothed belt or chain. The eccentric parts of the camshaft (lobes) are placed against the valve lifters (in this case, hydraulic). Under each of them are the springs to return valve in the closed position. By turning the camshafts during engine operation, the eccentric parts (lobes) are opening, and closing valves with the help of springs. On the right side of the drawing we see the intake valve, through which port enters the air-fuel mixture into the engine cylinder. On the left side are the exhaust valve and its port to ensure the evacuation of exhaust gases into exhaust system. Four-stroke engines have four strokes for each cylinder during one engine cycle, and therefore they are named "**four-stroke engines**". On the next sketch, we can monitor all four piston strokes in one engine cylinder during one cycle. Duration of one engine cycle takes two full rotations of the crankshaft, or 720° . In the first or **suction stroke**, the piston is in the downward path from its top dead center (**TDC**), and the intake valve is open. The

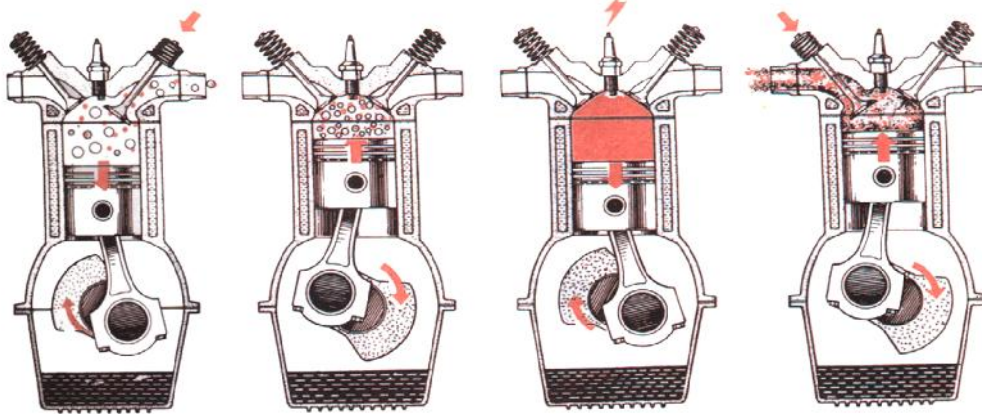

1. Suction

2. Compressing

3. Expansion

4. Exhaust

valve remains open until piston reaches bottom dead center (BDC), during which time, due to the under pressure, fuel-air mixture is sucked into the cylinder.

In second or **compression stroke**, the piston is in its upward trajectory from the bottom dead center and compresses sucked fuel-air mixture. During this time, both valves are closed.

In the third or **expansion stroke**, the piston is located at the top dead center, where compressed mixture is ignited and presses the piston down. In this stroke both valves remain closed too until piston reaches bottom dead center.

In the fourth or **exhaust stroke**, the exhaust valve opens and the piston in its upward trajectory displaces burnt gases from the cylinder through the exhaust port in the exhaust system (see illustration at the beginning of this text).

In the next photo we see the camshaft with precisely defined positions of cams for each valve and a

drawing which shows connection between camshaft and crankshaft by toothed belt.

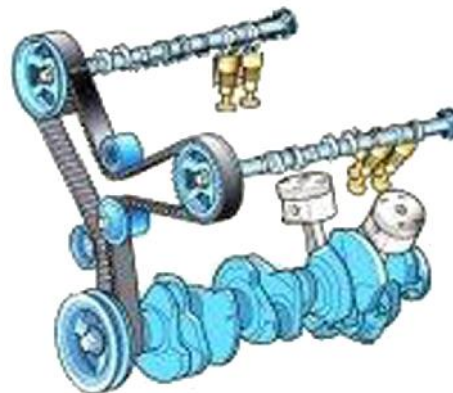

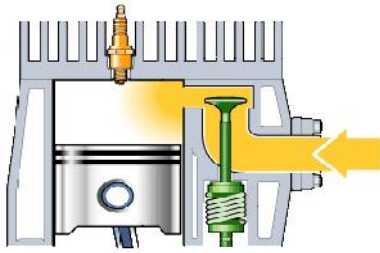

1. "Flat Head" engine

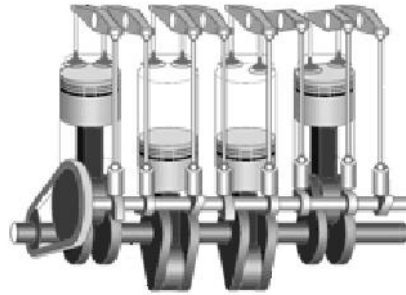

2. "OHV" engine

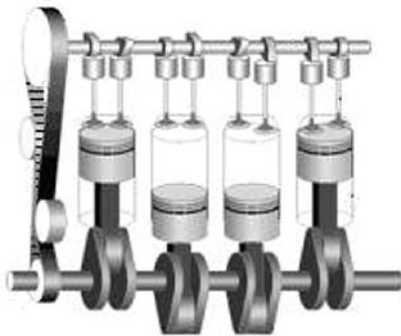

3. "OHC" engine

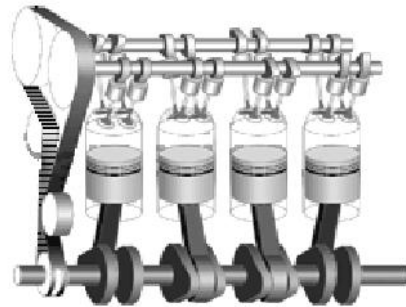

4. "DOHC" engine

The upper sketches are showing all four variants of **four-stroke** engine. By mid-fifties were produced so-called "Flat Head" engines. Such engines have valves located in the engine block and were raised directly by camshaft. Given that, all the working parts, as well as the intake and exhaust manifolds, were placed in and on the engine block. Therefore, cylinder head was very simple, basically just an engine hood with spark plugs. From there comes the name flat head or **Flat Head Engine**.

Another sketch shows **OHV** engine (**Over Head Valve**). These engines have a camshaft located in the engine block and valves in the

cylinder head. As shown, the valves are lifted by push rods, which lower part relies on the cam lobes and the upper on so-called rockers which open valves. In this type of engine, the gap between the valve and rocker arm is usually adjusted manually by bolt and nut. Crankshaft and camshaft are connected by chain or gears.

The third sketch shows the **OHC** motor (**Over Head Camshaft**). These engines have a camshaft located in or on the cylinder head. Such concept eliminated push rods, and the camshaft is leaning directly on engine valves. Between the camshaft and valves, we can see a cups or so-called hydraulic

tappets. Clearance adjustment between the valve and the camshaft is solved in two common ways. First, installing tappets with inserted shims which can be changed according to the required thickness, or hydraulic tappets into which is injected engine oil under the pressure with not possibility of returning. And on the third sketch, the **DOHC engine (Double Over Head Camshaft)** is shown. This engine concept has two camshafts in the head and one or two intake / exhaust valves per cylinder. In this case, it would be a variant with two valves, intake and exhaust, or the concept known as **DOHC 16V** engine. In these last two concepts of the engine, crankshaft and camshaft are usually associated by toothed belt, and rarely by chains.

Ignition cycle:

On the next sketch, we see simplified schematic presentation of the air-fuel mixture ignition cycle. This is a classic **OHV engine** with camshaft in the engine block connected with crankshaft by timing gear in the ratio 1:2, and push rods to open the valves. Push rod lies on camshaft and lifts the rocker arm which pushes the valve down with its other end. The sketch shows only one (exhaust), rocker and push rod, and therefore should be imagined the same principle on the other side of the sketch, which opens the intake valve.

If we understood previous sketches, it will be easy to explain the complete timing cycle on next one.

When the piston is in its descending direction, the lobe of the camshaft opens the intake valve. Due to the under pressure created in the engine cylinder, air-fuel mixture enters the engine cylinder. At the turn of the piston in the upward path, camshaft lobe will pass the valve, and valve spring will lift the valve and close the inlet port. So, on the piston upward trajectory, both valves are closed. Moving upwards, the piston compresses sucked air-fuel mixture. Just before reaching the top dead center, the ignition of air-fuel mixture will occur (ignition timing). Ignition timing which occurs before top dead center is specified by the manufacturer, and it depends of compression ratio and fuel octane value.

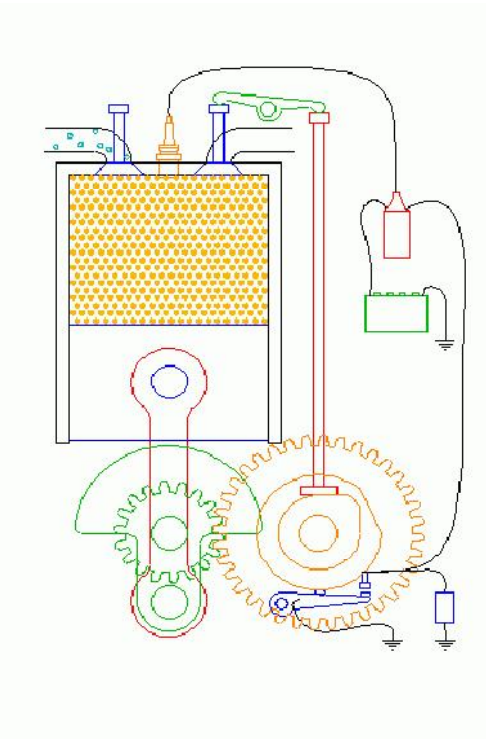

In a specified time (Ignition timing) compressed mixture will be ignited by spark plug, but how? High voltage on the spark plug, causing a spark, comes from the induction coil (Ignition coil). Induction coil is connected by central high voltage cable to the spark plug. Two end connectors on coils create a circuit in it, which allows the induction of high voltage (approximately 15 000 V). In the sketch we see one side of the coil connected to the positive battery terminal and the other to the ground terminal via mechanical switch also known as **contact breaker** or **Engine points**. In the sketch is also visible part of the eccentric shaft at which contact breaker hammer slips breaking electrical circuit, while the anvil is fixed. Since this is a single-cylinder engine, we see only one lobe. There are so many lobes on distributor shaft, as many cylinders are in the engine. On automobile engines, this contact breaking complex is situated in the engine **Ignition distributor**. But the principle is identical to the presented.

Spark on the spark plug appears in the following way: During the first three-strokes, contact breaker points are connected and the electrical circuit is closed. During this time, the **Ignition coil** will induce a high voltage. In the precise scheduled time, the shaft lobe will lift the hammer, disconnect the points and break the electrical circuit. At this moment comes to the **Ignition coil** discharge through the central

high tension cable to the distributor cap. From **distributor cap** central terminal voltage flows through the **distributor arm (distributor rotor)** to the cylinder terminal on the **distributor cap** to which rotor is pointed. That is, the distributor is configured so that the rotor is always directed to the firing cylinder (**expansion stroke**).

Ignition distributor:

Previously, it was explained how spark occurs and air-fuel mixture is ignited in one cylinder four stroke petrol engine. The same way, the ignition functions in multi cylinder engines. To distribute sparks on multi cylinder engines, the **Ignition distributor** is used. Spark will be distributed to each cylinder at a specific time through the distributor arm and distributor cap. Distributor will also, with built in mechanism, adjust the ignition timing according to the engine revs.

The following photos show the typical position of ignition distributor on petrol engines. In the left photo, the ignition distributor is located on the engine block and driven directly by camshaft (on **OHV** engine with camshaft in the engine block), or by separate shaft driven by toothed belt (**OHC** engines with camshaft on the cylinder head). On the right photo, the ignition distributor is set directly on the one of the camshafts of the overhead cam engine. Other words, ignition distributor can be driven directly by camshaft or any other element connected to it.

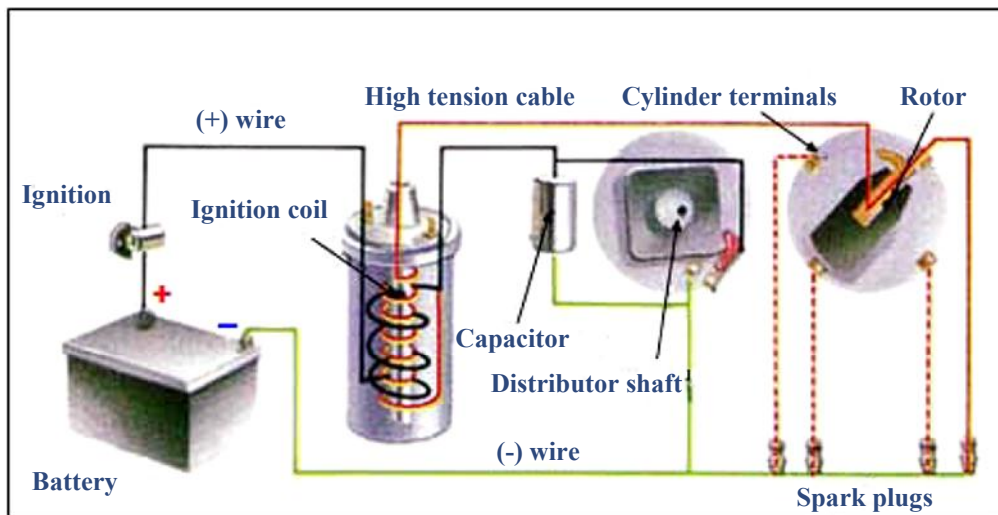
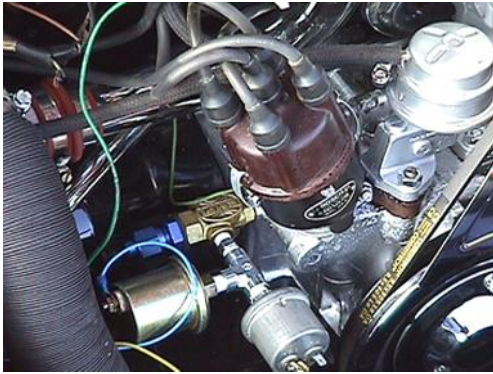

This schematic drawing explains the spark occurrence and its distribution per cylinder. In this case, it is a four-cylinder engine.

From the positive battery terminal current flows through the ignition switch to the positive terminal (+) of the ignition coil. From the negative terminal of ignition coil the current flows through the contact breaker to the battery negative terminal (-). Negative battery terminal is directly connected to the vehicle bodywork and the engine. This means that any metal component attached to the body or the engine has (-) on its housing.

Thus in practice, as opposed to this scheme, the (-) wire does not exist, the minus terminal is distributor itself. Thus, the capacitor instead of being wired to minus, as shown in this sketch, will be connected to the negative as it is mechanically attached to the distributor casing. The same applies for contact breaker and spark plugs. Such connection to the negative terminal is popularly termed as "**Ground connection**".

In the sketch we see the distributor shaft with four lobes. Every lobe, at exactly the right moment, will raise the hammer contact po-

int and separate it from the anvil, for which we said that is firmly fixed to the distributor (-). This position is shown on the sketch. During the openness of the contact breaker, the electrical circuit breaks and a high voltage is induced in ignition coil. This induced voltage tends to discharge. Discharge will occur between the positive and negative spark plugs electrodes. In its pursuit of discharge, high voltage could be partially discharged by spark across the open contacts on contact breaker. To eliminate this anomaly, capacitor is connected in parallel to the contact breaker positive terminal (hammer). Capacitor will absorb voltage when attempting to discharge across the contacts. So, the only possible way for discharge is across spark plugs electrodes. How the spark comes to spark plugs? Now when we know how the high voltage is induced in the ignition coil, it is necessary to clarify the distribution of sparks to each cylinder spark plug. Induced high voltage is flowing through high tension cable from the ignition coil to the central terminal of distributor cap. From the inner side of that terminal, voltage passes through the graphite conductor to the rotor (distributor arm). Graphite conductor, pushed by a spring on the rotor, will enable a constant connection between the cap and rotor during engine operation, in which case the rotor turns and distributor cap rests. This way we ensure the flow of high voltage from coil to caps

cylinder terminals over the rotor. On the first photo we see the outer side of distributor cap and its central terminal for high voltage from coil. In the next photo we can see the inner side of distributor cap. Here is visible central terminal with graphite conductor, under which is spring installed. The spring will push the central conductor to the top of the rotor contact (third picture). The rotor is placed on the distributor shaft and rotates with it. The rotor is installed on the shaft in a certain position, which provides the rotor tooth and the notch on the distributor





shaft. This position is determined in the way that rotor nose is parallel with one of the shaft lobes. This lobe is usually used to open contacts (spark) on the engine first cylinder. Now when we know that the rotor turns and the cap stands still, and that we brought a high voltage to the central part of the rotor, we can move on to the next phase, bringing the spark to the spark plugs.

Cap, which is installed on the ignition distributor, also has a certain position, which is secured with the tooth on the cap and groove on the distributor casing. As we already have example of bringing the spark to the first cylinder, we can continue in this order. So at the moment of ignition, or the spark appearance on the spark plugs, shaft lobe will open breaker contacts and the high voltage will discharge from ignition coil. We brought high voltage from coil over the distributor cap to the rotor. In this moment, the rotor will be facing the fixed contact (electrode terminal) of the first cylinder in the cap. On the first photo of the distributor cap,

cylinder terminals are marked from 1 to 4. These numbers indicate the engine cylinders which are linked by high tension lids with cap terminals.

The rotor inside the cap is directed towards the first cylinder terminal, and has not physical contact with it. There is a small gap between the rotor and terminal to prevent damages during the rotation of the rotor. However, the high voltage will jump across that gap with a tendency to discharge between the spark plug electrodes. With this last phase of bringing the high voltage to spark plug, we enable the occurrence of spark between the positive and negative electrodes on spark plug and ignited compressed air-fuel mixture in the engine cylinder.

Distribution of sparks on the other cylinders will flow in the following order. Let's see once again the previous photos. Imagine a rotor inside the cap on the first photo. The rotor will rotate in the direction of marked arrow. The next terminal on the cap is marked with numeral 3, means the third cylinder. When rotating, rotor aligns with the contact terminal 3, the lobe which is parallel to the rotor nose will open contact breaker. So, high voltage discharge again, and continuing so cycle after cycle.

The next sketch shows the ignition distributor plate on which contact breaker and capacitor are placed. We can see that the insulation of movable part of the breaker

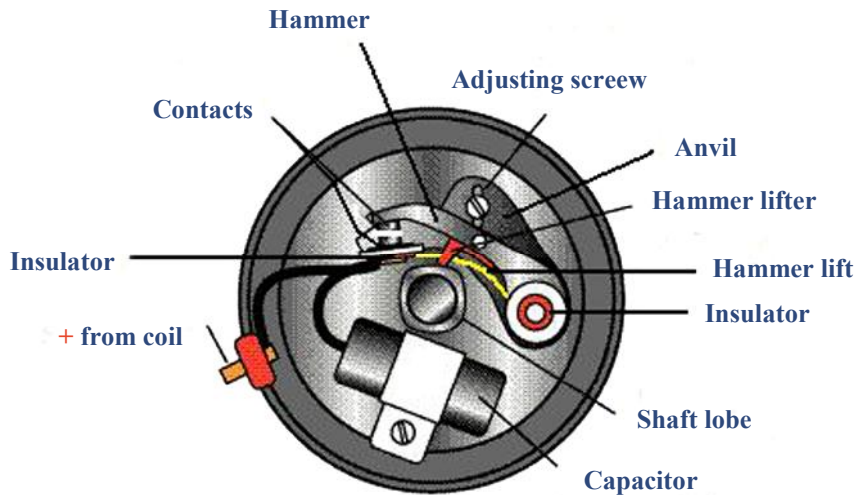

(hammer) is taken into account. Positive wire, which comes from coil negative terminal, is connected to condenser and a hammer which is attached to the insulated anvil. Anvil is directly attached with a screw to the plate, which is minus pole or ground itself. Thus, when breaker contacts are closed, current flows through the contacts to the ground (-) and the circuit is closed. When the contacts are separated, the circuit is interrupted. To prevent hammer to come in contact with ground when points are open, insulator is installed between hammer and anvil. The hammer lifter which slides on distributor lobe is made of plastic (insulator) too. It is noticeable that the anvil has a screw and groove for adjustment. This screw adjusts the spacing between the contacts in open position. The distance is measured by the moment when the hammer is on the top of the lobe. This space is usually about 0.40 mm. It is vital that this gap is set

by the specifications, for the time required for closing the circuit (induction) and time to discharge induced voltage. On the lower photo we see one of the most common types of contact breaker.



Transistor ignition:

In the period since the seventies to the nineties, when electronic ignition systems mostly replaced electric-mechanical ignition systems, the two electronic ignitions variant were installed in the vehicles: semi-transistor and transistor ignitions which replaced contact breakers and capacitors.

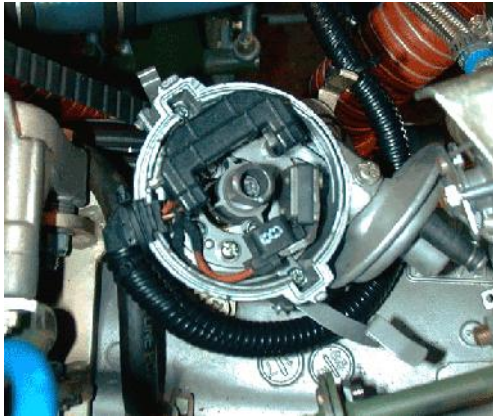

Transistor ignition is nothing else but throwing out the contact breaker from ignition distributor, or replacing the contact breaker with contactless. This modification eliminated the frequent servicing and replacement of contact breaker, as well as allowing greater precision of high voltage induction in the coil and its discharge (spark). On the upper photographs we can see how the transistor module is inserted instead of contact breaker and capacitor. It is also obvious that instead of the lobes to raise the breaker hammer, the shaft now has four teeth. When tooth passes close to the module, the voltage is generated in the coil. The generated voltage activates a transistor, which breaks the elec-

trical circuit (previously described). So, this transistor module performs the same function as contact breaker, only with much greater precision and maintenance-free.

On semi-transistor ignition, similar module is installed into the system on outer side of the ignition distributor. In this case, contact breaker remains, but capacitor is thrown out. Since the transistor requires very little power to perform the function of switch, there is no need any more for capacitor as very low electrical power flows through contact breaker and sparking (discharge) between contacts is eliminated. In other words, the wire from negative coil terminal is connected to contact breaker via transistor. Contact breaker is interrupting very low electrical power in circuit. These interruption impulses activate and deactivate transistor, which breaks or closes a circuit from coil negative terminal. With this modification, we ensured the eventual possibility of voltage drop and discharge across the contacts, as well as contact breaker long life. Namely, because very low current and voltage is passing through the breaker points, they will be saved of burned deposit and wear.

Ignition timing:

As already mentioned, ignition timing is the moment of air-fuel ignition in the engine cylinder. From the moment when air-fuel mixture is ignited, to complete combustion of mixture, some time

is needed. This time depends of the degree and speed of air-fuel mixture compression. Therefore, every vehicle manufacturer defined ignition timing, considering the engine characteristics and provided fuel. To enable carrying out checking and adjustment of ignition timing, the manufacturer has set ignition timing marks on the front crankshaft pulley or on the engine flywheel. In the lower photo we see the marks on the front crankshaft pulley. On all engines, there is mark **0 (zero)**. This mark indicates when the first piston is on the top dead center (**TDC**). Furthermore, on the plate behind the pulley the marks in degrees are set for reading and adjusting ignition timing before **TDC** as specified by manufacturer. Aligning the notched part of the pulley with the mark **0**, we get the first piston on the **TDC**. If the manufacturer has

defined the ignition point **4° BTDC (Before Top Dead Center)**, we shall align the pulley notch with mark labelled **4°** on the plate, as shown in the sketch. Once we have set the engine crankshaft, or the first piston in a position at **4° before top dead center**, we are going to adjust the ignition distributor. Loosening distributor clamp, we shall set the distributor in a way that rotor is aligned with first cylinder terminal on the distributor cap, or in most cases, we can find the first cylinder mark on distributor housing. This would be the first static pre-ignition setting. The real ignition timing adjustment we will make with stroboscopic timing light, and engine running. In setting specifications for particular engine, we will find the information (in this case) **4° BTDC, at 850 RPM (Revolution Per Minute) + vacuum or - vacuum**, means: connected or disconnected engine vacuum from distributor. If we use simple stroboscope (without degree adjustment) on an engine, we will slowly turn the ignition distributor, until the flashing light coincides with pulley notch and the plate mark **4°**. If we use a stroboscope with adjustable timing angle, we will do next: Set the degrees numerator on gun at **4°** and align the light with a notch on the pulley and a zero on the plate. Finishing setting, we defined the beginning of air-fuel mixture ignition, or the occurrence of spark at **4° before the piston arrives to TDC**. These four degrees will give enough time to complete

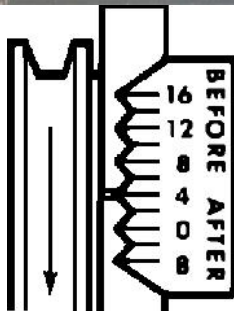

combustion of the mixture until piston arrives to **TDC**, from where it will be pushed down with full force created just when piston passes **TDC**. On the following photos a conventional ignition distributor with vacuum pump and the stroboscope with adjustable timing degrees are shown. Such timing light will enable us to adjust the ignition timing on engines that do not have a plate with marked degrees, but only notch on the pulley or flywheel and a point or peak on the engine block, which indicate (0) the **TDC**. In such cases, we will determine degrees on the timing gun and match the markings. Connecting the stroboscope is very simple. Positive and negative clips are connected to the vehicle battery, and, so-called, **Pick-up** module to the spark plug high-tension lead of the engine first cylinder.



Ignition timing set as described will be accurate only at **850 RPM**. As the engine revs increases, so the ignition timing must change. Namely, as the engine turns faster, the time of air-fuel combustion is getting shorter. Therefore, proportionally with the increased engine revs, it is necessary to read-just ignition timing to ignite the mixture before than we determined for **850 RPM**, and also read-just back when revs are reduced. For this purpose, in ignition distributor two mechanisms are installed to do this job.



In the next drawing we see disassembled ignition distributor. Beside already described parts, pay attention to a vacuum pump and centrifugal weights. The vacuum pump is connected with a hose to the carburator and responds to under pressure in the carburator. It is mechanically connected to the contact breaker carrier plate, and turns it in the housing. So, depending of the under pressure in the carburator, a vacuum pump will turn the whole plate with contact breaker, and open contacts a little earlier than we determined for **850 RPM**, and automatically allow the spark appearance on spark plug earlier.

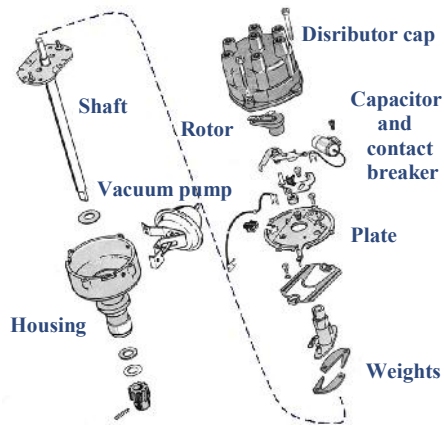

Two centrifugal weights will stretch due to centrifugal force and do the same thing with the plate as a vacuum pump does. The difference between these two mechanisms is the following: Weights are reacting very slowly and therefore a vacuum pump, which responds promptly, is built in. However, once the weights catch the speed, they keep the plate in the required position while the vacuum pump is relieved of load. Of course, these shifts are accurately defined for each engine type when distributor is constructed. In today's car with electronic fuel injection, there are still such ignition distributors, while on others this job is done electronically by ECU.

The next photo shows the distributor plate with a transistor ignition module. We see how the module is installed on the same plate as contact breaker is, and vacuum pump lever which turns the plate. In the sketch below, the centrifugal weights are shown in normal position and stretched due to centrifugal force.

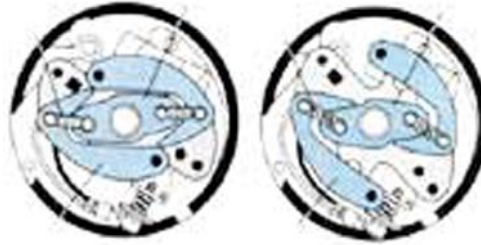
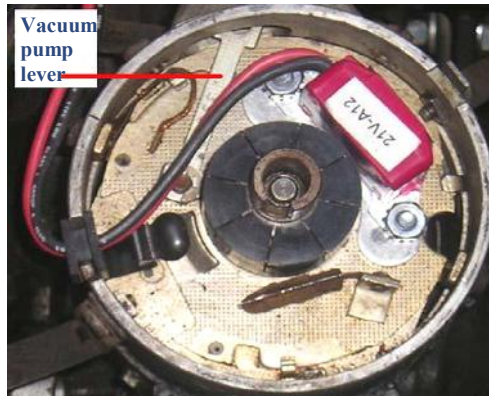

Spark Plugs:

Having learned previously how the high voltage comes to spark plugs, it is necessary to say how the spark occurs and something about spark plugs characteristics. The next drawing shows a typical spark of today's petrol engine with one negative electrode. When we say with one negative electrode, it means that there are spark plugs with more negative electrodes. In fact, today we can meet plugs with two, three or four negative-electrodes. All these modifications are made to improve the spark. But in any case, it is not advisable to install a modified spark plug, if it is not predicted by the vehicle manufacturer. The modified spark plug will not produce the expected effect, because the rest of the electronics associated with high voltage is not adapted for such spark

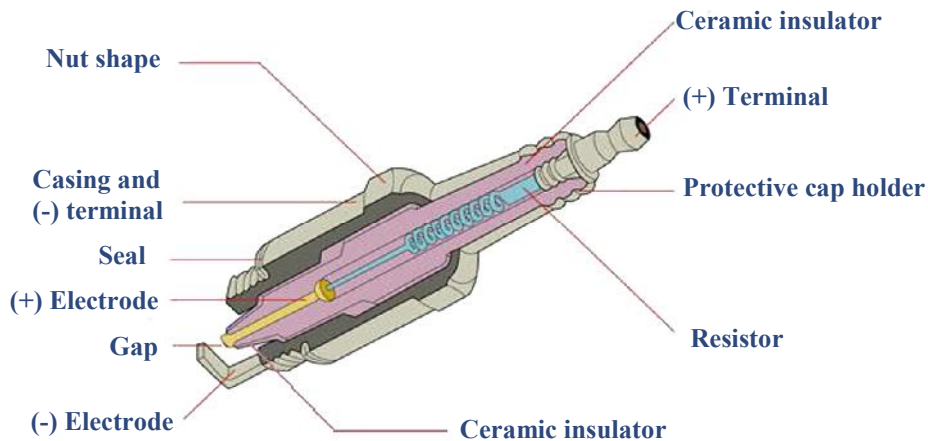

plugs.

Spark plug is composed of a metal casing, with wrench shaped top of the body and thread cut bottom.



Inserted seal is double layer designed to be squashed when spark plug is screwed in and tightened. In fact, insufficiently tighten spark plugs can be often found on engines. The reason is the fear of over tightening the spark plugs when replacing. When tightening the spark plug, resistance can be felt in the moment when we come to the seal. Most people will at that moment stop further tightening the spark plug, thinking that the thread came to an end and the

spark plug is tightened. However, just at that moment, further tightening is required to squash the seal.

Through the central part of the spark plug passes positive electrode, cast in ceramic insulator. On the positive electrode high tension lead will be plugged. Negative electrode is welded to the body of spark plug, where, over the head and engine block, which are connected to the negative battery terminal, closing the circuit. The gap can noticed between positive and negative electrodes. This distance is determined by the spark plug manufacturer (from 0.7 to 1.1 mm).

High voltage (approximately 15 000 V), brought by high tension lead to the positive electrode, tends to discharge. The discharge will occur between positive and negative electrodes, which result is spark.

Spark plugs calorific value is often mentioned without proper

explanation of that term. Certainly, that spark plug heats up when engine is running. This warming can be controlled to prevent air-fuel mixture being self ignited by spark plug heat. Namely, overheated spark plug could ignite the mixture before the time, determined by the ignition timing. Therefore, for every particular engine proper spark plug calorific value is determined. The range of calorific value is determined by the length of ceramic insulators from the top of positive electrode to its lower part, which connects with the spark plug metal casing. So, as ceramic insulator is longer, spark plug is hotter and its calorific value is higher, and vice versa. With shorter insulator, spark plug cools faster through the metal casing and cylinder head. Therefore, its calorific value will be lower.

In above drawings we can see displayed hot and cold spark plug.

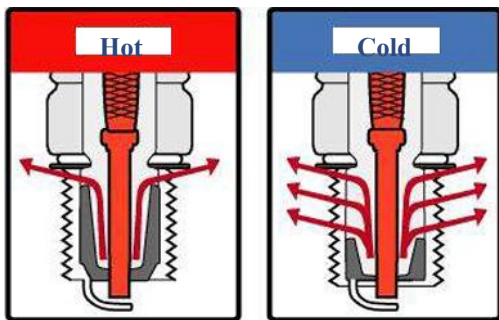

It is clear that the hot spark plug insulator is considerably longer than on a cold spark plug. It is obvious, that longer insulator will heat up much faster than shorter. When selecting the spark plug calorific value, we have to consider

HEAT TRANSFER

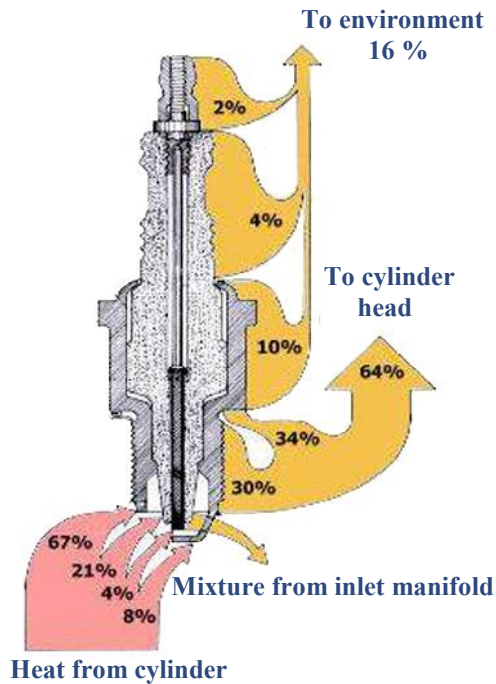

that spark plug is hot enough to burn the smut deposits and on the other hand cold enough not to cause the self ignition of air-fuel mixture. Considering that all petrol engines do not develop the same temperature during combustion, it is necessary to determine appropriate spark plug calorific value for each type of engine.

The above drawing shows the heat transfer from the spark plug in percentages. As noted before, the greatest amount of heat is released through the spark plug casing screwed in the engine head. The remaining part of the heat is lost by radiation into the environment, and a small portion of heat is released being cooled by air-fuel mixture entering the cylinder in the intake stroke.

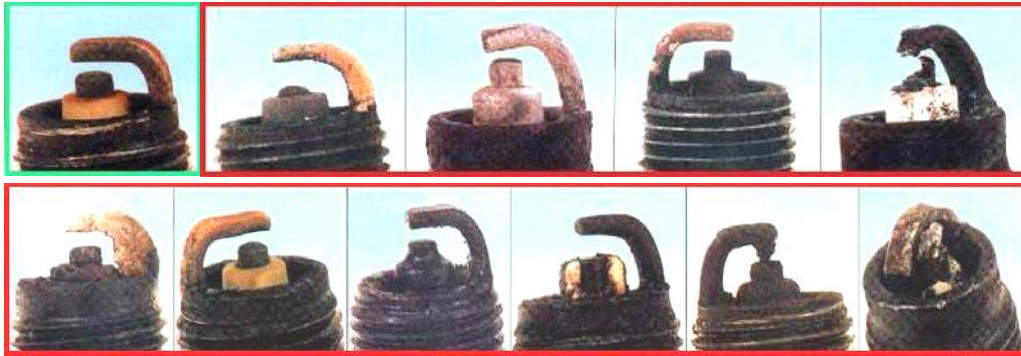

The upper photographs show the spark plugs which operated under different conditions. The first photo shows the spark plug which has worked in a properly tuned engine, and which is also in good condition. Furthermore, from left to right, one can see the spark plugs pointing to worn out engine, or other irregularities:

- Worn spark plug electrodes will cause a difficult engine start and increased fuel consumption.
- Overheated spark plug due to incorrect timing.
- Smut deposits on the spark plug indicate a rich mixture.
- Melted electrodes indicate inadequate spark plug calorific value, incorrect ignition timing or lean mixture.
- Such a large smut deposit usually occurs due to excessive oil consumption.
- Yellowish smut colour on the insulator indicates the spark plug overheating, due to aggressive driving.
- This oiled spark plug indicates piston rings or valves seals wear, and causes interruption of the spark plug, on one or more engine cylinders.

-Crack of the ceramic insulator will cause inadequate calorific value or unadjusted gap between electrodes.

-Such filled gap between the electrodes with smut will cause engine oil in combination with unburned fuel.

-Bent negative electrode is most likely a result of inadequate spark plug installation (long thread).

These examples certainly show how spark plugs replacement is not just a routine job. Careful examination of sparks plugs gets a picture of the engine condition and its setting. Each of the above examples will cause poor engine performance, hard engine starting and a number of other phenomena like: misfiring, backfire from exhaust pipes etc. Smut deposits will isolate the spark and cause a cylinder malfunctioning, partially or completely. Of course, the consequences will be greater than the loss of performance. Namely, the fuel injected into malfunctioning cylinder will obviously not burn, but will pass the piston rings and leak into the engine sump. In such case, oil will be diluted, and the effectiveness of engine lubrication

tion will drastically drop.

Physical damage of the spark plug is also very dangerous. Fallen particles from spark plug can damage the cylinder and piston. Fallen negative electrode from spark plug can easily make the hole in the piston. Namely, due to lack of negative electrode, the high voltage will seek for nearest negative pole to discharge. In most cases, the closest negative terminal is the piston on TDC. Due to the sparking between the positive electrode and piston, the hole in it is inevitable.

In order to maximally avoid these problems, the market offers a wide range of different spark plugs. Of course, that some types of spark plugs have an advanced quality of material on the electrodes, housing and the insulator. But, it is completely wrong thinking that the expensive and high-quality spark plugs can solve existing problems of the engine. This is largely a waste of money. Better spark plugs can be installed for aggressive driving regimes, but on the standard car will be primarily to remove the engine failures, and then expect improvements in performance and fuel or oil consumption. In other words, standard spark plugs from known manufacturer will fully meet engine requirements, if the engine is in good condition and well tuned. Finally, it is more reasonable and cost-effectively installing a standard sparks plugs and replace them every 10-15000 miles, than installing very expensive spark

plugs, which will not give the expected effect, and because of its



This is the one of spark plugs with platinum electrodes. Manufacturer provides a limited warranty to 160,000 km. Why is guarantee limited and how long such spark really lasts?

price, we will be forced to clean smut deposits very often, instead of just replacing them.

Carburetor:

Now, when we know how the air-fuel mixture is ignited in the four-stroke gasoline engine, it is necessary to say how mixture is created and enters the engine. For this purpose, very complex device is constructed and named the carburetor.

This text will cover only the basic principle of carburetor. These simple carburetors are commonly found on motor vehicles until mid nineties. Over the years, carburetors have been modified so that only about them the book could be written if all models are covered

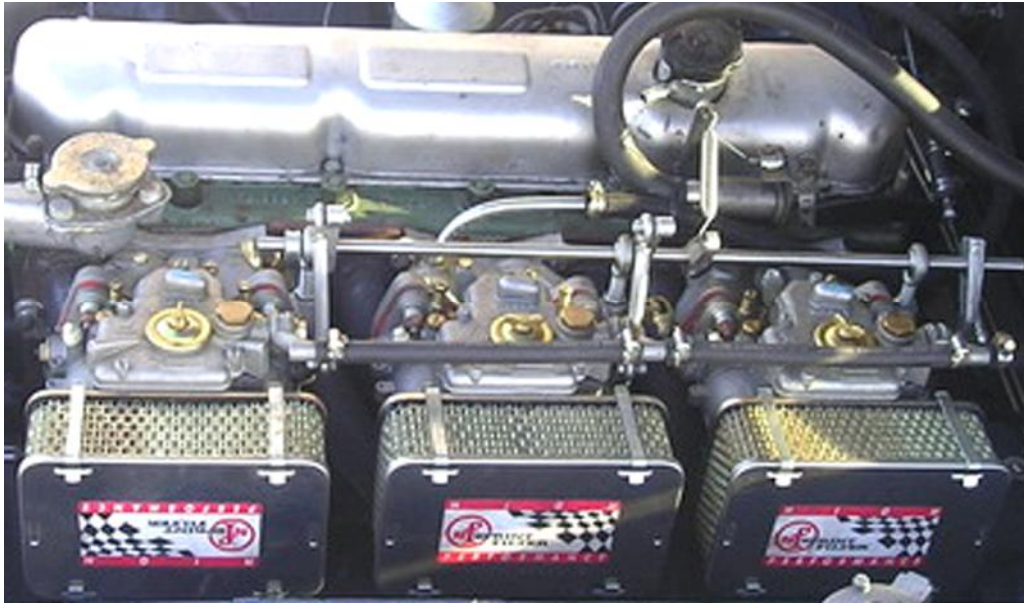

and modifications made to them. Each manufacturer of carburetors attempted to dominate on the market, and therefore carburetors were more sophisticated every year. In eighty percent of vehicles, we will find following carburetor manufacturers: "Weber", "Solex", "Dellorto", "Zenith", "Stromberg", "SU", "Pirburg" and "Carter", which is most often found in American vehicles.

Two basic types of carburetors are present on cars: mechanical and vacuum. Vacuum carburetors are divided into diaphragm and piston types.

In the next picture we see a typical simple carburetor with manual choke. From left to right, the basic mechanical controls and adjusters are marked: 1, Connection for throttle cable which opens and closes the carburetor throttle butterfly, 2. Idle adjusting screw which regulates the throttle open-

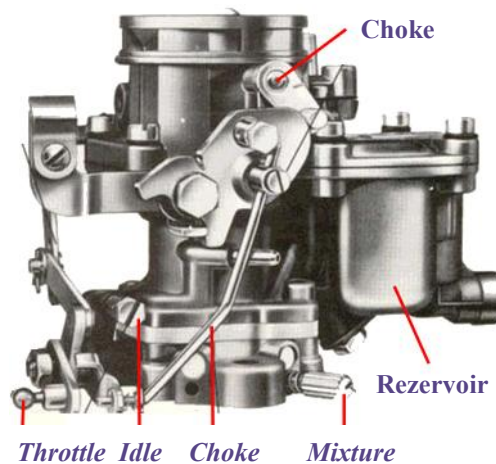

ing for optimum engine idle. 3. Choke mechanism shows the lever which increases RPM at idle, in proportion to the choke closeness. 4. Mixture adjusting screw at idle. Further on, the carburetor fuel reservoir and choke butterfly shaft are indicated.

Following the next drawing, we will elaborate the principle of the carburetor. Fuel brought by the fuel pump from vehicle fuel tank, enters into the carburetor reservo-

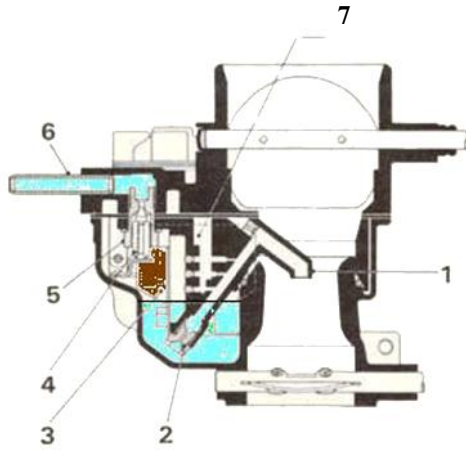

air through the hose marked with number 6. In the carburetor reservoir float is immersed (3), and associated with a valve needle (4), which slides freely in its seat (5), and closes and opens the fuel supply. The float and needle will control the same constant level of fuel in the carburetor reservoir. The amount of fuel, which will pass through the tube (1), is determined by the size of nozzle hole (2). Blender or diffuser, which allows a certain amount of air to be mixed with fuel during suction, is indicated by the number (7).

The main task of the carburetor is to provide the proper amount of air-fuel mixture during the suction stroke.

Hence, the carburetor is a very complex device, in which manufacturer calculated very accurately the fuel level in the reservoir and the holes sizes through which fuel and air are passing. Starting with fuel level, it should be noted how it is of great importance. In the sketch we can see that the fuel level is slightly lower than the tube (1) from which fuel is sucked out. If the fuel level was slightly higher, the fuel would leak into the carburetor. In opposite case, if level was lower, the under pressure created in the carburetor would not be sufficient for fuel suction. In other words, the fuel level must be accurately determined, to avoid overflow or lack of fuel.

Through the central part of the carburetor air is sucked due to under pressure caused by suction strokes. As seen on the all drawings, the central part of the carburetor has been narrowed, and is called a venturi. This shape was made in order to maximally speed up the air flow, just in the position of venturi where the fuel pipe (1) is located. This acceleration of the intake air will enable the fuel suction even on the low engine

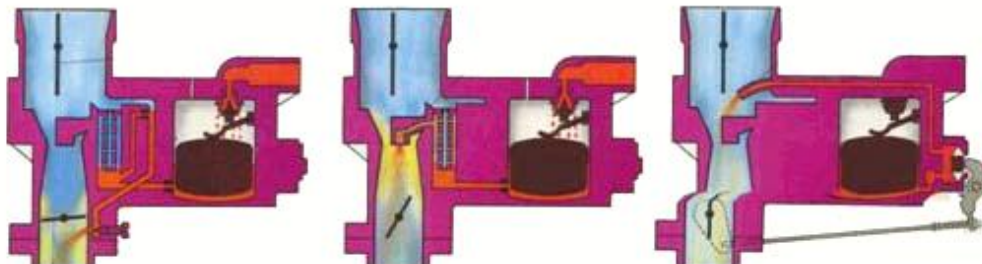

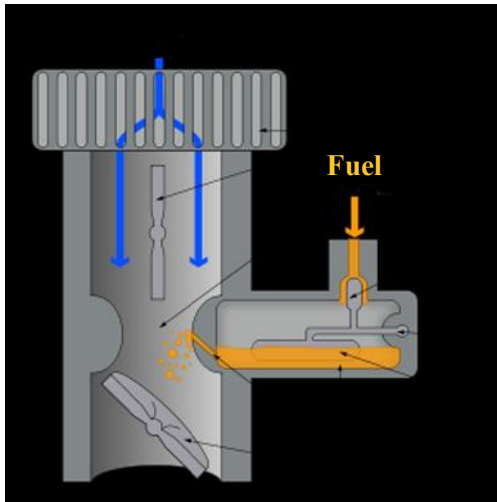

RPM, what would otherwise be impossible. So, the air flows through the venturi creating under pressure, under which fuel is sucked from carburetor reservoir. When the air flow is faster, the sucked amount of fuel is greater, and vice versa. To control the amount of air and automatically amount of fuel entering into the engine, at the bottom of the venturi butterfly is installed. With butterfly, whose shaft is connected to the accelerator pedal via cable, we are controlling opening or closing air flow through the venturi. If we get back to the sketch, we will see that the pipe (1) is not directly immersed in the fuel reservoir. Namely, in such case there will be an uncontrolled suction of liquid fuel from the reservoir, causing overflow. That is why a blender nozzle is made and connected with pipe (1). Built-in blender nozzle has an opening to atmospheric air and series of precisely calculated bores, through which air mixes with fuel in pipe (1). Thus, the fuel sucked through

the fuel supply pipe (1), will mix with air and atomize into a fine spray of fuel and air, and get into the venturi.

On explained way, the carburetor works when driving the car. However, carburetor is far more complicated than it initially appears. When we stop the vehicle and release accelerator pedal, we shall almost completely close the carburetor butterfly. In this case, there will be not enough under pressure in the venturi to suck the fuel from feed pipe (1). For this purpose, in the venturi casing special passage is bored to provide air fuel mixture to the engine at idle. This passage is drilled exactly on closing position of the butterfly, and with reason. Through the small gap between butterfly and casing, when butterfly is partially open, air is sucked. Again, the under pressure which is created in this section sucks mixture of fuel and air through these passage. Unlike in previous case, where we had not possibility to adjust the mixture as it was pre-defined by carburetor design, the mixture for engine idling is adjustable.

The third basic function of a simple carburetor is preventing engine dead spot when accelerating rapidly. During rapid acceleration, butterfly in venturi will open suddenly too. At that moment, under pressure in venturi drops and fuel can not be sucked from the feed pipe. Certainly, as only air is sucked into the engine at that specific moment, the engine will stop

working for a second. Such an occurrence will cause hesitation or twitching of the vehicle, until the under pressure increases enough to suck the fuel again. This problem is solved by installing the injection pump, which is mechanically connected to the butterfly shaft. Pressing the accelerator, injection pump is activated, and when butterfly suddenly opens an extra amount of fuel will be injected in venturi and solve the problem of engine dead spot. All three described operations are shown in the previous drawing. First, operation at idle. Second, driving mode. Third, injecting fuel.

On drawings, we can also see choke marks. The simplest option is choke butterfly, almost identical to already described, which is located above the venturi. Choke can be controlled manually or automatically.

Manual adjustment is solved by cable which is associated with a choke puller inside the vehicle. Automatic choke is usually associated with bimetallic regulator. Bimetal is made in the form of spring which stretches or shrinks due to difference in temperature to which is exposed. This assembly is usually heated by water or electricity. In the cold, the bimetal is holding a choke butterfly closed, and it slowly opens up, as bimetal warms up.

Choke partially closes the air inlet in the venturi and thus

allows the entry of a richer mixture, which is essential for a cold engine. It is also mechanically connected to the throttle shaft, so that in a closed position in proportion increases **RPM** at idle.

On the photo below clearly are visible choke butterflies in closed position, as well as bimetallic assembly on the right side of carburetor.

Apart from a single carburetor, vehicles can be equipped with double throttle or multi-carburators. Double throttle carburetor will have two venturis. Such carburetor is working as a single, while the second venturi is just starting to open after about 3000 **RPM**. Multi-carburators are carburators which feed separately each engine cylinder with air-fuel mixture. Such carburators do not always have to be separate devices, but in pairs of two or even four in one for engine in **V** formation. Carburetor "two in one" is shown below. These are two carburators in one case, and butterflies are mechanically linked.



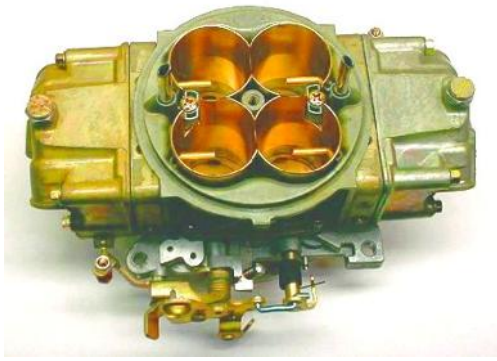

This carburetor "four in one" apparently looks very complicated. However, it is about four single carburetors, located in same housing. This concept is made for very practical reason: instead of setting four individual carburetors and a good deal of the mechanics associated with them. The constructor has merged four venturis, which use the same fuel reservoir.

If we fully understand the basic principle of the carburetor, we can easily deal with a lot more complicated carburetor. All modifications in various types of carburetors are relatively easy recognized since they are made to improve the engine performances in various conditions, as well as fuel consumption.

Vacuum Carburetors:

Vacuum carburetors are divided into two types, diaphragm and piston. Working principle of these carburetors is very similar to the previously described mechanical carburetor. However, the prevailing belief is that these carburetors are more efficient than mechanical.

When mentioning membrane carburetor, we shall most often



meet above presented **Stromberg** carburetor with a diaphragm diameter of 175 mm.

On the schematic representation

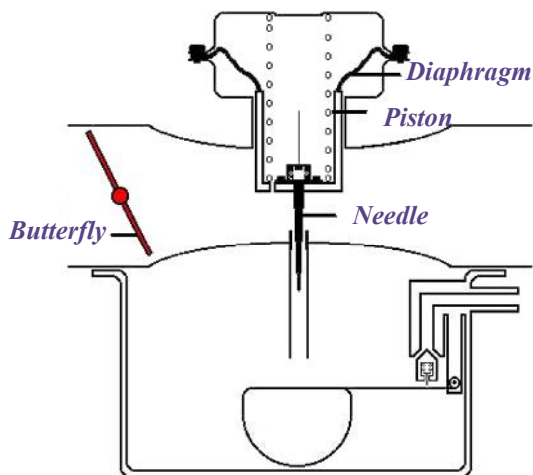

can be seen venturi which is identical to the previous one. However, in this case, the suction is performed in a different way. In the tube, immersed in the fuel reservoir, conical needle descends and rises. The needle will with its conical shape determine amount of fuel

sucked trough venturi. The needle is attached to the piston, which rises and falls, as venturi butterfly opens and closes. How the piston rises and falls? As pressing accelerator, venturi butterfly opens. Passage in piston will enable creation of under pressure in the chamber above the piston. Since the carburetor housing and the top of the piston are associated with diaphragm, the piston will rise in proportion with created under pressure. When under pressure drops by closing the butterfly, spring will push the piston down. To avoid piston fluctuations due to under pressure rapid oscillations, the oil shock absorber is inserted into the piston.

Summary: As throttle butterfly opens, vacuum or under pressure lifts piston. Piston raises conical needle which allows the suction from carburetor reservoir. Conical needle and piston rising are exactly defined by carburetor design, in order to obtain the correct amount of fuel in all positions of butterfly openings.

These carburetors generally have no injector pump as mechanical, because there is no possibility of sudden

air entry, and therefore engine dead spot does not occur. Why is that so? First, due to the vacuum piston lifts and allows air to enter. Raising piston automatically lifts the needle, and due to a vacuum created in the venturi, follows immediate fuel suction.

Piston carburetor works exactly like a membrane. The only difference is in the upper part. Instead of the diaphragm, the carburetor has a cylindrical cap, in which is located extended wider part of piston. This wider piston replaces the diaphragm.

Manual choke on this carburetor is often solved by mechanically lowering the needle seat, allowing richer mixture for cold starting (lower sketch).

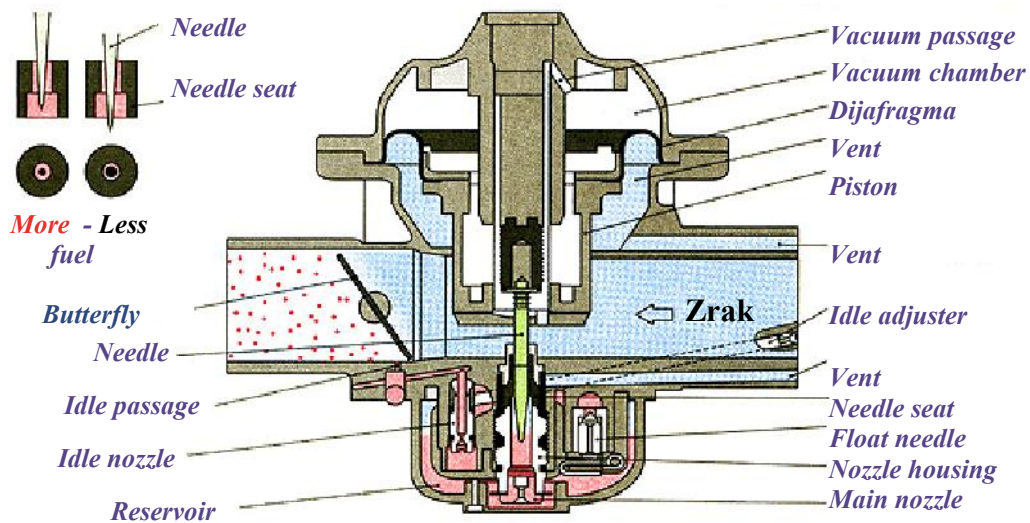
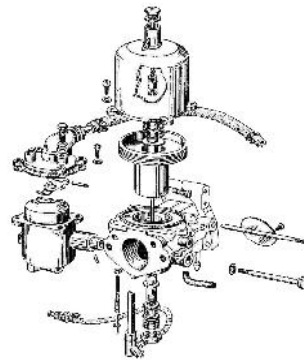



Fuel Pump:

In order that everything described in previous chapter is functioning properly, it is necessary to provide fuel feed to the carburetor. Engines with carburetors mostly use mechanical fuel pumps, and rarely electric.

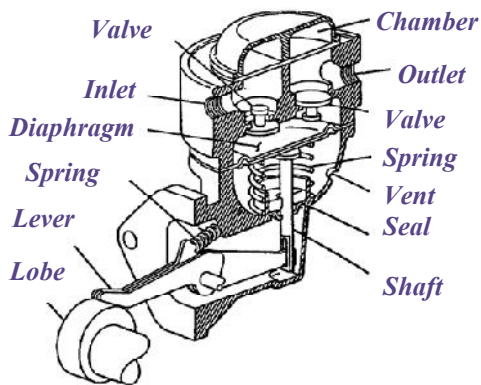

Mechanical fuel pump is usually driven by engine camshaft. The lobe on camshaft raises and lowers the pump lever, which is associated with the pump diaphragm. Fuel pump sucks the fuel from the fuel tank and pressurize it to the carburetor. Beside the diaphragm



in the pump are installed two one-way or irreversible valves. In its downward trajectory, the diaphragm draws fuel into the pulsating chamber, where the inlet valve open and the output is closed. In its upward trajectory diaphragm pressurises fuel in the chamber. Due to the fuel pressure, the inlet valve closes and the outlet opens.

If we come across with electric pump on carburetor engine, it will be most often a centrifugal pump similar in appearance to a pump that is used in vehicles with fuel injection. The next fuel pump model is pulsating electric pump. This pump works on the same principle as the mechanical, but instead of being driven by camshaft, diaphragm is operated by solenoid or (electromagnet). Described fuel pumps are also called low pressure pumps. The output pressure of these pumps is about 0.20 bars. The most common problem associated with diaphragm pump is full or partial failure of one of the valves. In such a case, the pump

works, but without any or just a partial effect, with little or no outlet fuel pressure.

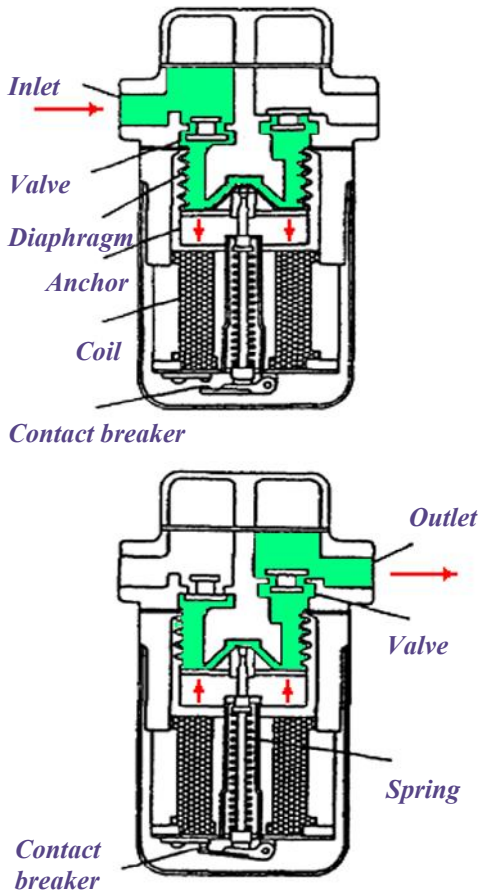

Pulsating electric fuel pump

Centrifugal electric fuel pump

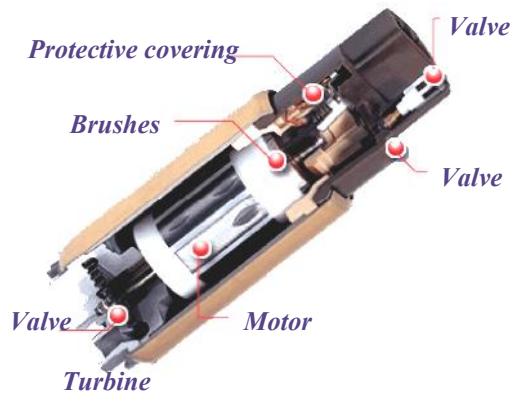

Centrifugal electric pumps are divided into low and high pressure pumps. Low pressure pumps are used to supply the carburetor with fuel, while high pressure pumps are used in cars with direct fuel injection. High pressure pump means that fuel supply pressure is approximately 3 bars.

The centrifugal pump consists of electric motor, irreversible and by-pass valve. On the pump underside where turbine is located pump sucks the fuel. Fuel comes out on top of the pump, through the irreversible valve. This valve provides a constant fuel pressure in the system. By-pass valve is used for the leakage of excess fuel in circulation.

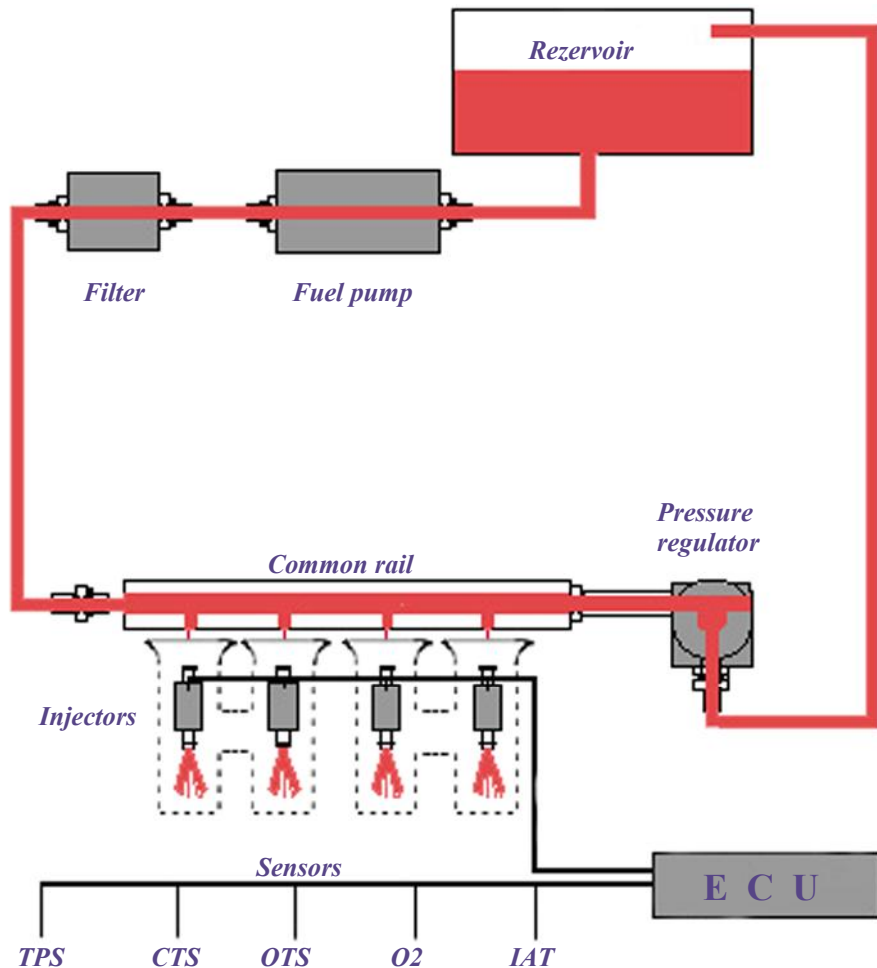

Fuel injection:

Or engine with direct fuel injection.

The upper drawing shows **Multi-Port Fuel Injection** system, which is the most common in today's cars. **Multi-port** means, that for each cylinder one injector is provided. On competition cars, we can find even two injectors per cylinder.

The principle of direct fuel injection system is very simple. However, engine management, which determines how, what and when, is complex. Complexity of engine management is visible through the chapters of the **ECU** and engine sensors.

Simply put, fuel pump sucks fuel from tank and distributing it through the common rail to each cylinder injector. Injectors, which operate on the principle of the solenoid (electromagnet), opens for a limited time, when electrical circu-

it closes. Electromagnet opens injector, and fuel is injected into the cylinder. As we know, time and duration of injection will be determined by the ECU based on data collected from the engine sensors. At the end of the common rail, a fuel pressure control valve is installed. In the event of excessive pressure, the valve will let the excess fuel back into the fuel tank.

On the lower sketch we see a typical arrangement of the fuel injection components. In this case, the fuel pump is located in the fuel tank. But this is not the rule. The fuel pump can be external, in which case is located along the reservoir, under the vehicle. Common rail and injectors are usually

assembled as compact unit located on the engine inlet manifold.

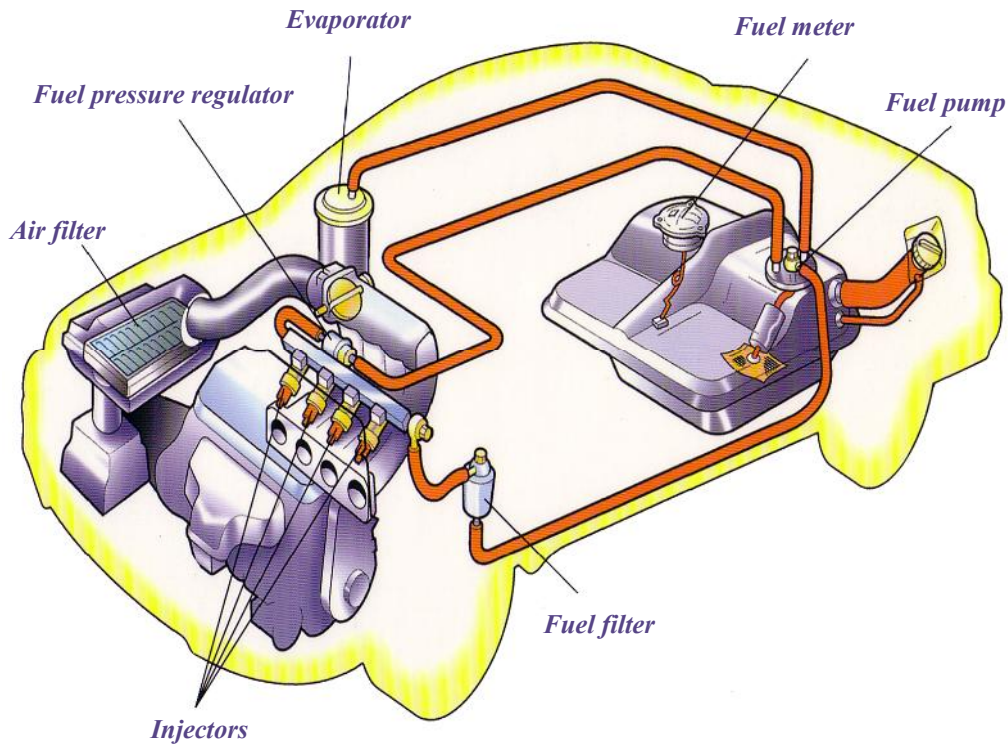
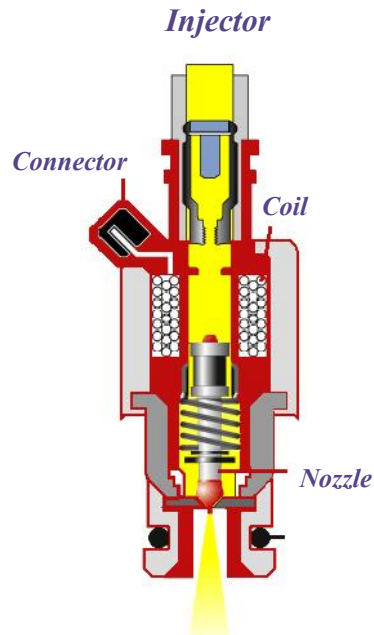



Solenoid injector

Mono-Jetronic:

Vehicles with smaller engine capacity are equipped with **Mono-Jetronic** fuel injection system instead of **Multi-port** fuel injection systems (lower sketch). Fuel injection engine with only one central

injector works exactly the same way as the multi-port system. The only difference is in the number of injectors. Of course, with this simplified injection system a high performances are lost. However, such vehicles are primarily designed for city driving, where drivers are not so demanding.

K-Jetronic:

Mechanical fuel injection system is very rarely seen these days. This system operates mechanically and it is not controlled by **ECU**. High pressure pump supplies injectors with fuel through distributor. Mechanical injectors open fuel flow due to pressure which compress the spring inside injector. The principle of operation is similar to **Diesel** injectors.

Mono injector

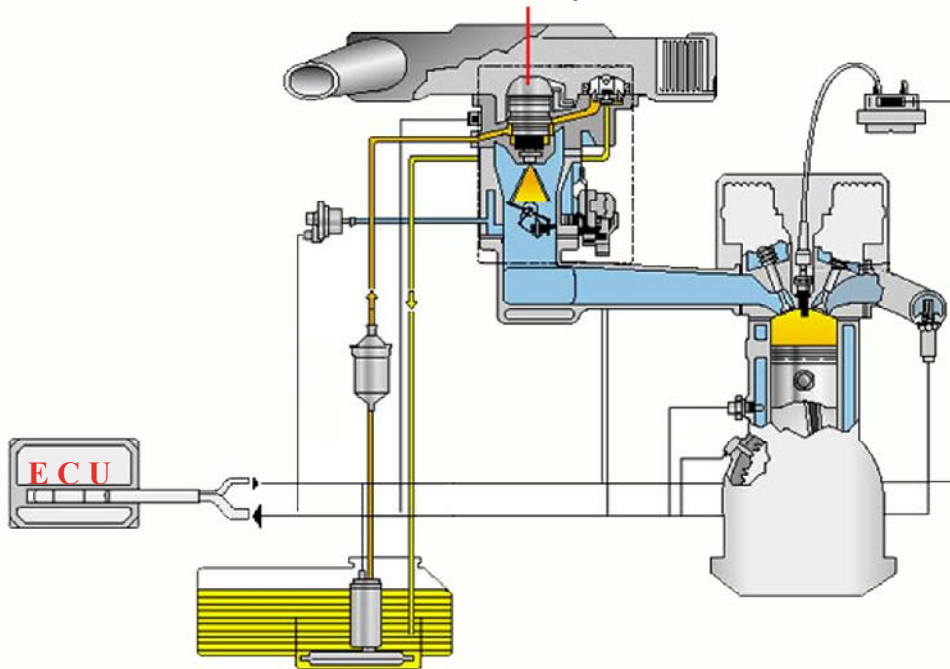

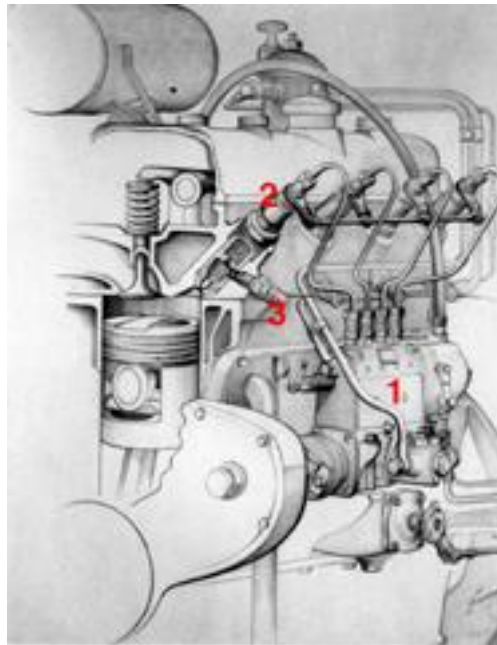
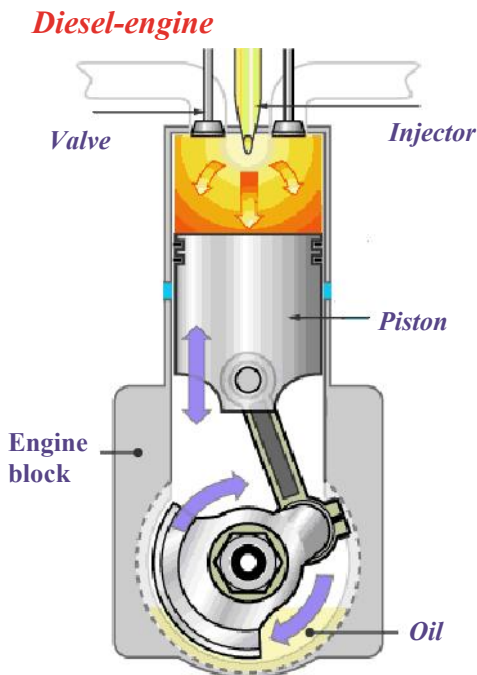

1. Pump 2. Injector 3. Glow plug

The concept of diesel-engine is almost the same as gasoline. The differences in these concepts relate to the different principles of operation. Unlike gasoline engines, where air-fuel mixture is ignited by spark, the air-fuel mixture in diesel engine is self ignited.

In the second stroke, where the air-fuel mixture is compressed, the diesel engine only compresses intake air with compression ratio around 25:1. In such a compressed air temperature rises to 700-900 ° C. Just before the TDC (moment of ignition) injector injects fuel directly into the engine cylinder. In contact with hot air, occurs an air-fuel mixture inflammation and expansion, which pushes the piston down.

There are two types of injectors in diesel engines, mechanical and electromagnetic or solenoid. Mec-

hanical injector opens under the fuel pressure from mechanical high pressure pump, also known as Bosch-pump.



Mechanical injector

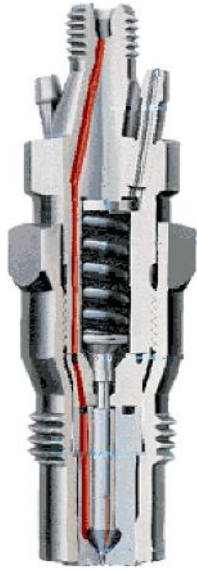

In the upper drawing of a mechanical injector, the fuel entrance is marked with red colour. Under pressure of approximately 120 bars, the fuel will push the spring what will lead to the injection. The spring is accurately calibrated for each type of engine in order to leave out the fuel under defined pressure. Excess fuel will return to the fuel tank via a drain at the top of the injector.



High pressure piston fuel pump

Fuel pressure is coming from the high pressure pump. We distinguish two types of such pumps, piston and rotary. Piston pump has bu-

ild-in cam shaft, which, at a specific time, raises the piston inside the pump and oppressive fuel in each injector.

In addition to fuel high pressure, this pump has the task to distribute fuel in firing order to injectors, as well as controlling the duration of injection, depending of the engine acceleration. Similarly to ignition distributor in petrol engines, the pump has centrifugal weights, which will alter ignition timing, according to engine revs.

Rotary fuel pumps are more commonly found in passenger

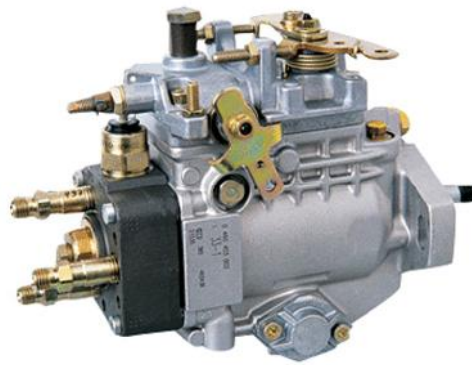

High pressure rotary pump

cars. This pump described in the simplest terms, oppressive fuel by rotation of the rotor inside it and distributes it to the injectors at a specific time. To enable adjustment for accurate fuel injection, pump is linked by timing chain or toothed belt with the engine crankshaft, as in the case of the ignition distributor on petrol engines.

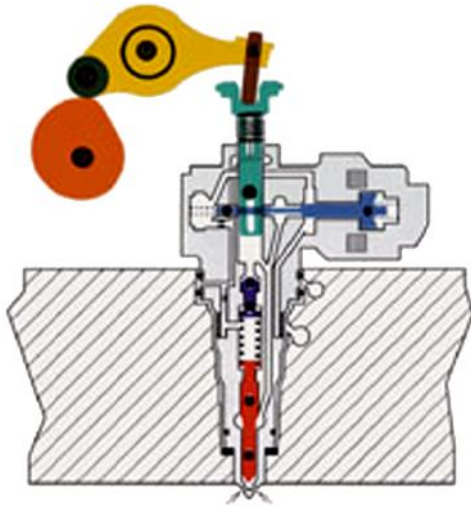

In a constant effort to simplify engines with the aim of reducing production costs, manufacturers invented injectors with build-in high pressure pump (upper sketch). However, unlike previously described, this system is rarely used.

In order to eliminate very expensive and complicated high-pressure pump from system and replace it with simpler high pressure pump, manufacturers have transferred the task of fuel oppression to the fuel injector. As can be seen in the sketch, camshaft lifts the rocker at a specific time. The rocker depresses piston which oppressive fuel, and comes to the injection. Certainly, it was very complicated to adjust injector for proper dosage of fuel at different engine RPM, so the further modification of this system is made by incorporating electronics in system. It was the forerunner of today's diesel fuel injection system, known as "Common Rail" or freely translated, fuel supply by

common pipe. Engines with this fuel injection system, which is the most frequent in today's vehicles, we will find under the names **HDI**, **CDI**, etc.

However, before we move to the description of "Common Rail" injection system, let's discuss a little bit more about diesel engine.

Described systems are divided into indirect and direct injection.

In indirect systems, fuel is injected

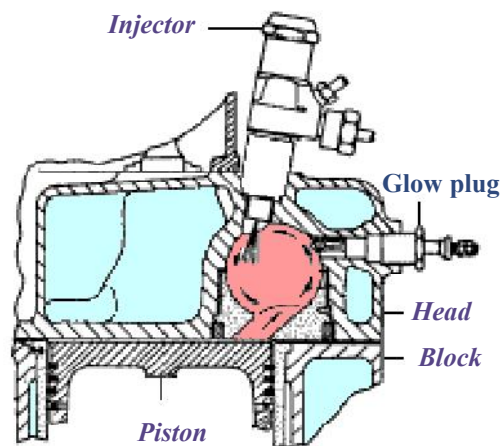

ted into the pre-combustion chamber. Compressed air in the chamber creates a swirl. During injection, the fuel will be evenly mixed with compressed air. Engines in which the expansion takes place in pre-ignition chambers, work a lot quieter and smoother than engines with direct fuel injection.

Engines with direct fuel injection, achieving greater efficiency, and therefore better fuel economy. In direct injection system, the fuel is injected directly into the engine cylinder, or the expansion chamber which can be positioned in the cylinder head or in the piston as

shown on this drawing.

On the below drawing we see

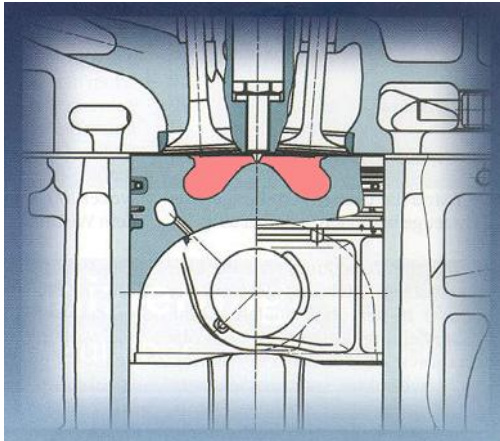

expansion chamber formed in the engine piston. When designing compression chamber, the vortex of compressed air which will evenly mix with injected fuel is taken in account. These types of engines are mainly installed in commercial vehicles, and rarely personal. The reason is aforementioned noisy and hard working engine which makes unpleasant vibrations.

On the previous sketch we can see marked mixture heater (**glow plug**). The heater is only used for cold engine start. Namely, the temperature, which is achieved by compressing the air, is lost through the cold piston walls, cylinders



and cylinder head. To reach the required temperature to ignite the mixture, heaters are used. Unlike the former diesel engines where mixture heating was assisted on several ways, today's cars have built-in heater timers which control the heating duration. They are associated with the engine temperature sensor and so can accurately determine the need for mixture heating. Engines with direct fuel injection, usually can be started without the use of heaters, since the concept of expansion chamber, lowers the temperature loss. Increased compression ratio, higher fuel pressure on injectors and atomization of injected fuel will also improve cold engine start without glow plugs.

As already mentioned, today's diesel engines use **common rail** fuel injection system. Timing and duration of injection determines the **ECU**. Just like in the gasoline engine, the **ECU** will determine very precise injection timing, as well as the required amount of fuel, calculated on the basis of collected engine sensors data. Advantage of common rail system is elimination of very complicated and expensive high pressure pump. Now, much simpler very high and constant pressure pump is used (1200-2000 bars). Metal pipes from the pump to the each injector are also eliminated from system. Instead, a common rail, or common high-pressure single pipe is used. Common rail connects all engine injectors in series.

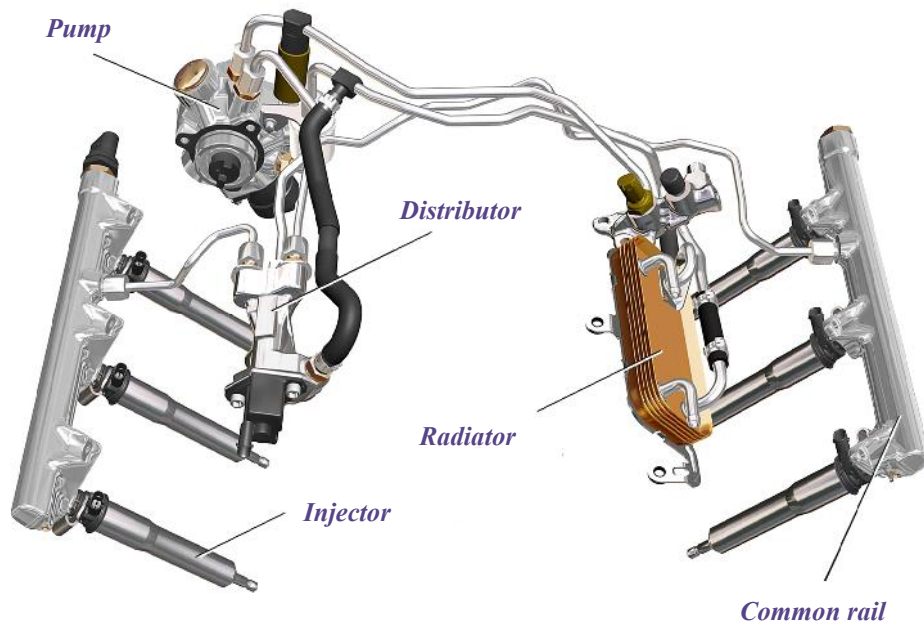

On the above drawing we see two common high-pressure pipes. In this case it is six cylinder V form engine, where such situation is unavoidable. However, when it comes to in-line engine, it is easy to imagine that only one tube connects injectors on four, five or six-cylinder engine (lower sketch).



Injected fuel atomization under extremely high pressure and precise determined amount of fuel, as well as the ECU injection timing control, provides maximum engine power exploitation, with minimum fuel con-

sumption.

Turbine:

From previous chapters it is easy to conclude that it is possible to regulate the amount of fuel mechanically or electronically. But with air, the situation is different. Its mass, density and temperature can only be measured. As engine power depends of the amount of fuel and air mixture, vehicle manufacturers are trying to bring with various systems as much air into the engine as possible. Increasing the amount of air, proportionally we can add fuel and get a larger amount of



mixture, which when burns produces more engine power.

One of the first innovations for delivering additional quantities of air into the engine was a **Supercharger**. This charger was driven by belt and it compressed the air by impellers, or rather large gears inside the case (lower drawing).



Disadvantages of these chargers are their size, weight and cost of production. But even so, the supercharger is kept up to date as an option for engine modification.



The first photo shows the supercharger, which is mounted on a V engine and positioned in the middle, between engine heads. The upper photo shows a mechanical charger of smaller capacity, which is suitable for installation as an additional engine component next to the alternator, hydraulic pump and air conditioning

92

compressor.

In today's cars, **turbo chargers** are mostly used. These chargers are very efficient and have small dimensions.

Turbo charger consists of two turbines. One turbine is driven by engine exhaust gases, while the other sucks air and compresses it into the engine. Both are connected to the turbine shaft. At one end, the turbine driven by exhaust gasses turns the shaft, while at the other end the same shaft drives a

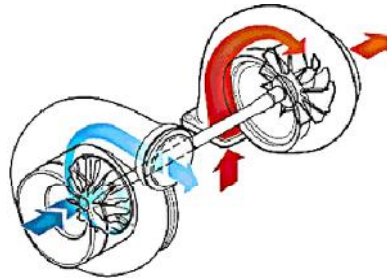

second turbine to compress the air.

To get an idea of air pressure that can be produced by such turbine, should be known that turbines are turning up to 150,000 revolutions per minute. Certainly, for such rotation a perfect lubrication is necessary. Therefore, the turbi-



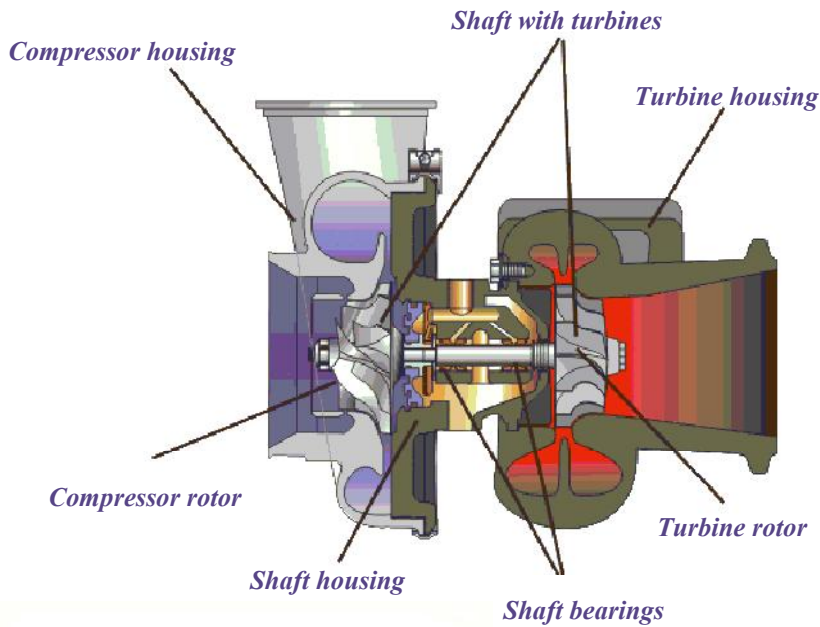

ne is connected to the engine lubrication system and it is lubricated in the same manner as the engine crankshaft bearings.

On the previous photo and next drawing, vacuum valve can be no-

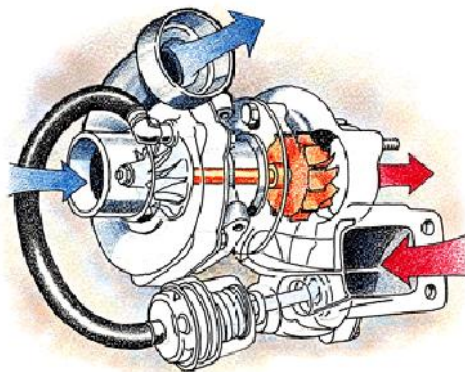

ticed. It is connected with the Bypass flap on the entrance of exhaust gases into the turbine. This valve is fitted to prevent intake of excessive amount of air into the engine. As can be seen in the sketch, the valve can be connected directly to the intake turbine. In such a case, the valve will respond to the under pressure and pull the flap which will redirect the exhaust gases by a separate channel in the exhaust system. Since the valve is adjustable, it is possible to determine when to divert gasses and control turbine spin. In today's cars, this valve is connected to another valve, which opening regulates the ECU. This second valve is usually operated by solenoid actuator also controlled by ECU. Computer will control

the vacuum leak through the valve which operates the flap.

In practice, we often come across the name **turbo-compressor**. Namely, the simplified name "**turbine**" refers only to a turbine driven by engine exhaust gases. The other turbine, which suck in and compress the air is called compressor.

Intercooler:

Translated, intercooler means air cooler.

It can be assumed how much heat is transferred from the turbine to the compressor and thus in the air that enters into the engine. Knowing that heated air expands, proportionally to temperature, losing the air mass is unavoidable. To obtain as great air mass as possible, it has to be cooled. For this purpose, intercooler is installed



between compressor and engine intake manifold. Intercooler is very similar to engine coolant radiator. It is usually located under the engine coolant radiator, or often on the lower front left or right side of the engine. Unlike the coolant radiator, the intercooler has much wider cells, in order to provide rapid air flow.

Described turbo system and Intercooler are used on petrol and diesel engines. On "V" engine formations, we shall find two turbochargers (one on each side of engine). This system is known as the **B-Turbo**.

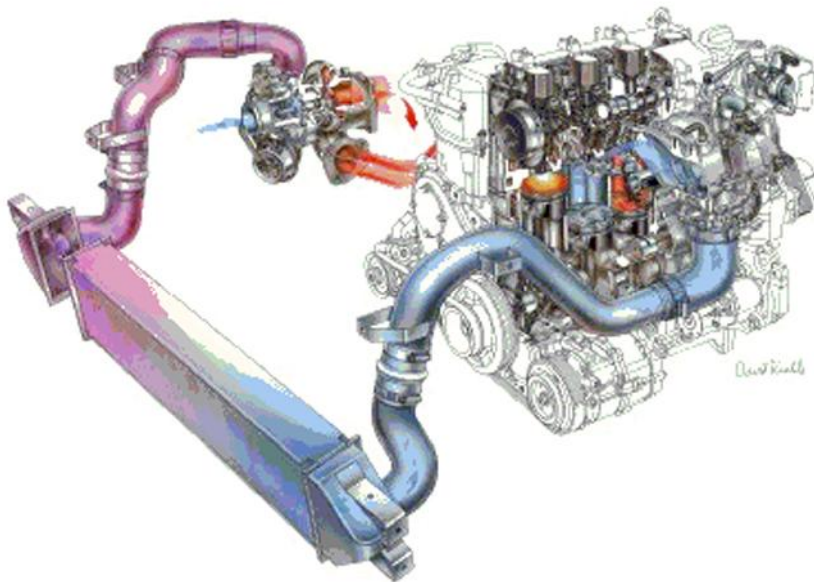

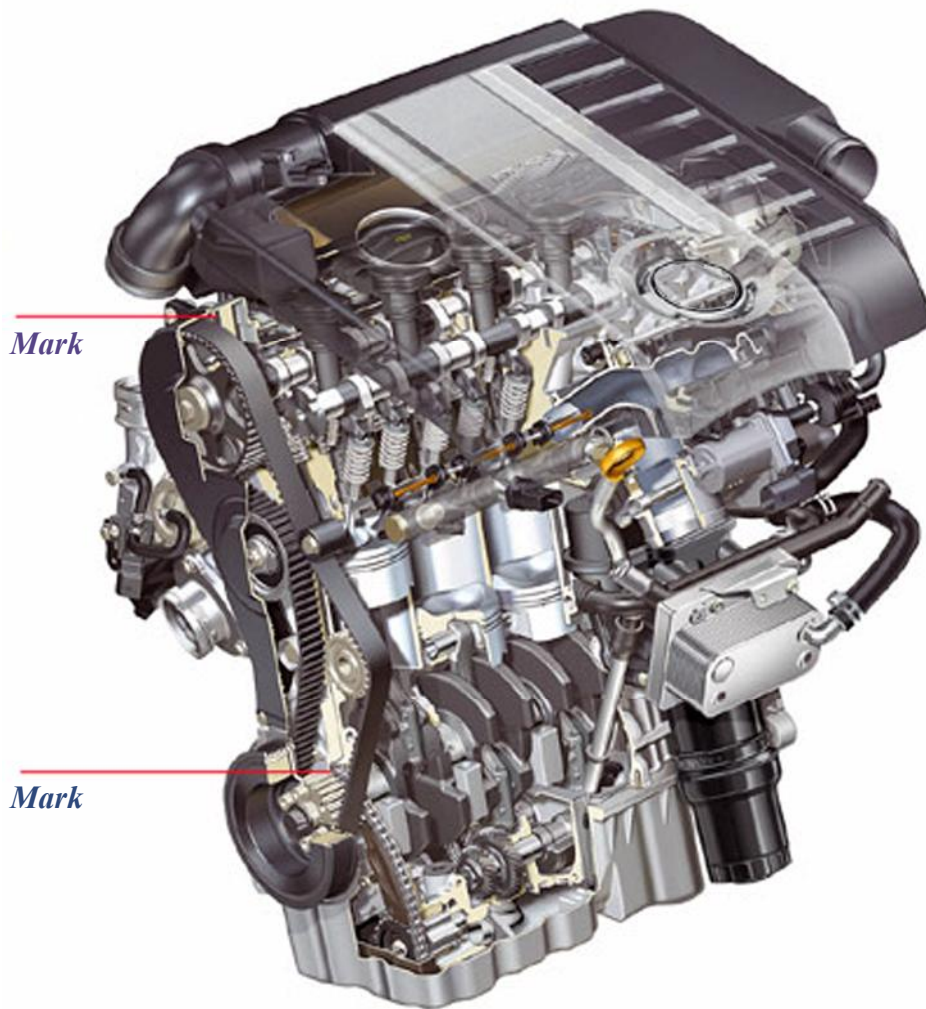

Timing belt and chain:

Through the previous chapters we constantly used the word "timing" or terms: valve timing, ignition distributor or high pressure pump rotation.

In order to align rotation of camshaft, ignition distributor or diesel high pressure pump, factory has exactly determined the position of connecting points with the engine crankshaft. Positions are marked

with point or line on the pulley or sprocket, and on the cylinder block and engine head.

We said, that complete cycle of four-stroke engine takes 720° , or two full crankshaft circles. As each camshaft lobe has to do only one action during one cycle, it is necessary to reduce the camshaft rotation by 50% compared to the crankshaft rotation. The same applies to the ignition distributor or high pressure pump, which only

ones have to ignite the air-fuel mixture or inject the fuel during the two engine revolutions of 360°.

Marks for the proper setting of camshaft, crankshaft, distributor or diesel pump are usually positioned to match with the ignition point of the engine first cylinder, or more accurately, the 0° of the first cylinder at expansion stroke. So, when these three elements are linked, the first cylinder piston is situated exactly on the top dead center (TDC). The first cylinder camshaft lobes are directed upwards, opposite the engine valves. In such camshaft position, valves are closed and the engine cylinder is in the expansion stroke, or commonly spoken, at firing point. Ignition distributor rotor will be directed towards the first cylinder terminal on distributor cap, while on diesel engine, the pump will be in the process of injecting fuel into the first cylinder. This setting is known in conventional term as the timing belt or chain setting.

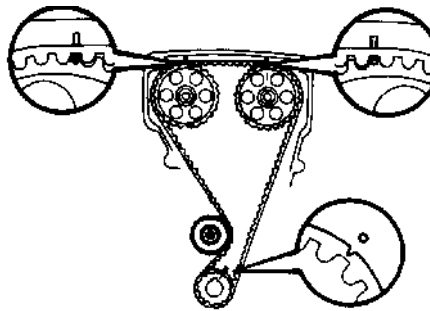
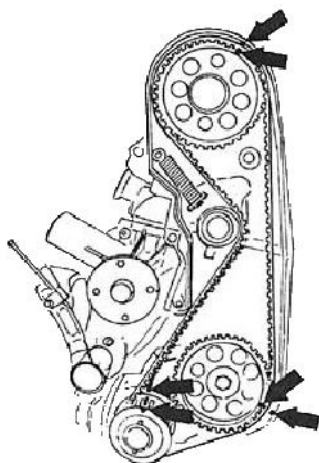

In the drawings, we see how marks match when all elements are set properly.

Such timing marking, in principle, is not the rule. We will often find the crankshaft marks on the flywheel, and sometimes they will not be found at all. To protect manufacturers authorized service centers, on certain vehicle models instead of marks, there are different ways of placing the piston in TDC. Thus we will find the hidden holes in the engine block, flywheel and pulleys through which pins has to be inserted to block the crankshaft, camshaft or high pressure pump in right position.

Setting the camshaft in the correct position can also be solved in several ways. On some types of cars we will have to line up the slot on the back of the camshaft with cylinder head horizontal line. On others we will find the marks on the camshafts themselves and their bearing cups, etc. In any case, the position of the camshaft, crankshaft, distributor or pump, is always the same. Of course, setting timing belt or chain has nothing to do with previously explained ignition timing setting which has to be done afterwards. The marks are

made for easy belt or chain replacement.

Let's imagine, what to do in a situation where the belt or chain should be installed, and there are no marks on the engine and shafts. Firstly, we have to set the first piston in **TDC**. The simplest way to do that is by blocking the piston on its way up in some position through the spark plug hole. Turning the crankshaft in one direction, the piston encounters a blockage and stops somewhere before the **TDC**. On the crankshaft pulley we'll record the position aligned with a point on the engine block which we have previously specified. Turning the crankshaft in opposite direction, the same situation will occur. Again we will record the position on pulley aligned with the mark on engine we specified before. After marking the pulley, we will remove the blockage from spark plug hole, find a middle position between two marks on the pulley and align it with a dot on the block, on which we focused. If the measurements and markings are made accurately, the piston is located exactly at the **TDC**.

With the camshaft we have similar procedure, measurement. If we are governed by the first cylinder during the setup, and we've already set the first piston in **TDC**, we will take in account valve arrangement. In other words, we set the camshaft lobes upwards, opposite the valves. In this position, the valves are closed, and first cylinder is on firing stroke. In order to

accurately align the camshaft with crankshaft, it is necessary to measure the height of each lobe in relation to a cylinder head. Precise measurement of the lobes will set the exact vertical position, with an equally remote exhaust and intake valves from the top of the lobes. Finally, we are only left with setting up the ignition distributor in a position where the rotor nose will be directed to the terminal of the first cylinder on the distributor cap or adjust the high pressure pump for diesel engine to inject the fuel in the first cylinder. Certainly we should take in account the specified ignition timing, if it does not solve the **ECU**.

In practice, timing belt or chain distention is often ignored, and more attention is paid to its possible breakage and development of severe engine damage. However, belt or chain distention, can cause a range of problems.

Consider the following situation. We are looking for the cause of power loss and the reason for troubled engine operation. Resort to all sorts of tests, including compression ratio measurement. We conclude that compression ratio is slightly weaker than specified and diagnosing worn out engine. How the compression ratio measurement is not relevant information about the piston and piston rings condition, we should put up a question: why we have so equal fall of compression on all cylinders.

The situation is as follows:

stretched belt or chain will cause a delay of the camshaft, and thereby late valves openings. Accordingly, in the suction stroke valves will open later than scheduled and automatically disable the full entry of fuel and air mixture in the cylinder. A smaller amount of mixture will lower the thrust on pistons (power loss). Late intake valve closing will cause returning of some amount of mixture back in the intake manifold during compression stroke, and lower compression ratio. Furthermore, in the exhaust stroke, the delay of exhaust valve opening will not allow the timely displacement of burned gases, and there will be a partial compression of burned gases in the cylinder, which will decelerate piston in the fourth stroke. This is just a simple explanation of the problem with the camshafts delay, which is in fact much more complicated, when it is drawn in chart. Certainly, belt or chain distention will result in late ignition timing, in case of vehicles with adjustable distributors or diesel with conventional fuel injection. While on gasoline engine simple ignition timing adjustment will be possible and partially remedy the situation, on diesel engines it will be more complicated.

Chains are more susceptible to stretching than timing belts. Therefore, the manufacturers of more expensive vehicle models predicted a fine mechanical camshaft adjustment due to stretched chain.

In the very near future, camshaft

and its transmission will be eliminated from engines. Valve opening will perform the solenoids which will be managed by the ECU. If we fully understood the working principle of four-stroke engine, the advantage of such valve operation is not necessary to emphasize.

Finally, a small remark. Turning the crankshaft, unconnected or connected with camshaft in the improper respect, can cause damage to engine valves.

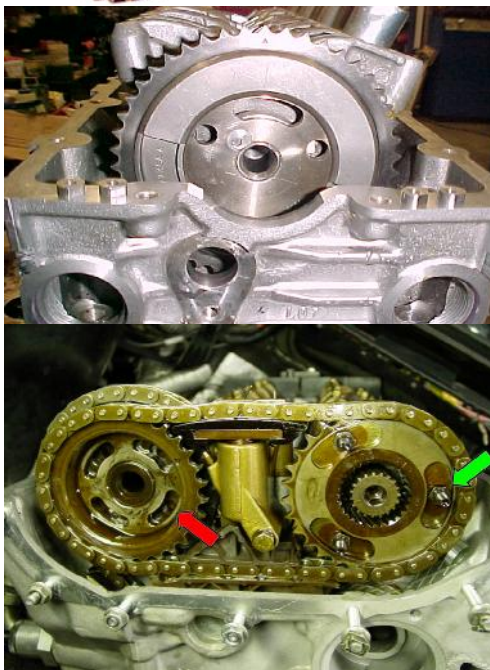
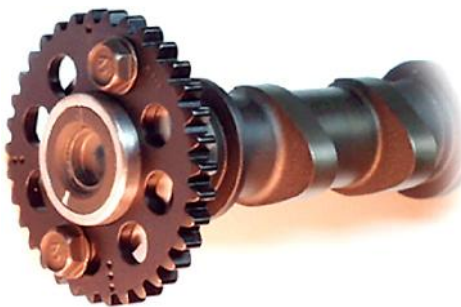

In upper photos are shown only two types of a range of ways to adjust the camshaft sprockets.

Engine V6 18V

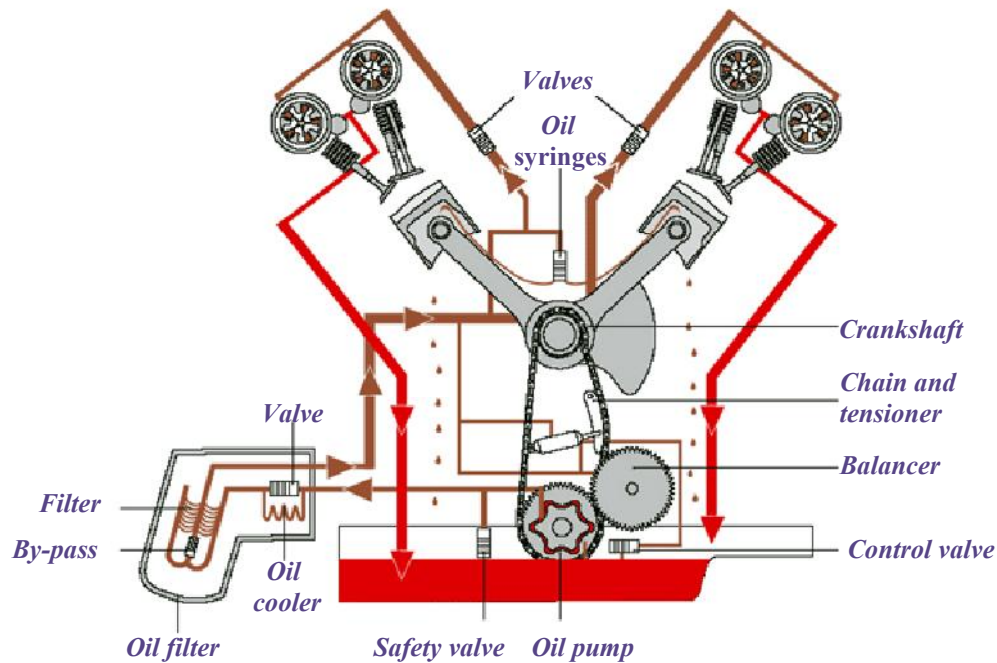

Engine lubrication:

For quality operation and long engine life, efficient lubrication system is extremely important. Just the cognition of the engine revs, which often go up to 6000 RPM, indicating the necessity of a very complex and efficient engine lubrication system.

Pouring the oil through the upper part of the engine, flows in its lower part or the container, commonly known as sump. The quantity of oil scheduled to fill in each engine is accurately calculated on the basis of the capacity of all channels for lubrication and oil filter. Oil consumption is also taken in account.

Taking all these parameters into account, as well as the possibility of negligence to control the oil level at least once or twice between the regular services, determines the required amount of oil. Additional quantity of oil is always determined due to faster oil cooling.

Engines that have incorporated the oil cooler in the system (below), will require smaller quantity of oil in the sump as better oil cooling is achieved with cooler assistance.



However, even where the engine oil cooler is not installed, there are various modifications which improve the oil cooling. For example, we shall often see the sumps made of aluminium with a ribbed surface. This solution will keep the oil temperature far lower than sump made of steel sheet.

The oil level in the engine will be always slightly lower than the engine crankshaft in order to prevent so-called breaking up oil during its rotation.

Oil pump, immersed in the sump with engine oil will distribute oil through lubrication system channels and the oil filter which will prevent the entry of any particles in the system. The oil under the pressure will be distributed through



the crankcase and crankshaft channels (upper photos). A thin layer of oil, which will be formed due to the oil pressure between the crankshaft and big end bearings

on the piston rod, will allow virtually non-contact piston rod rotation around the crankshaft.

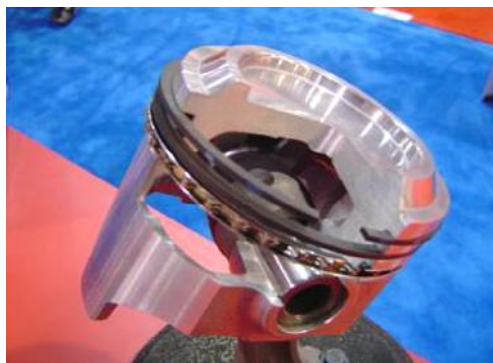
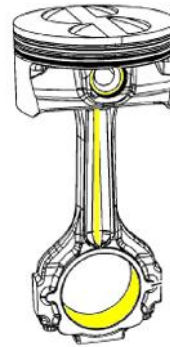

In better engines, pistons will be lubricated by syringes (see the first drawing), through which oil will be injected on the piston lower part. On some engine types, connecting rod has a hole through its entire length, so the pressurized oil from the crankshaft will lubricate the piston (upper sketch). In the above piston cutaway, we see the third piston ring which is meshed shaped. Oil will pass from inner piston side trough oil ring holes and thus lubricate the surface of the piston stroke.

Passing through the channel, oil will come in the engine head and lubricate the camshaft on the same principle as the crankshaft. Finally, the oil from the head flows

through large openings in the engine head and block back to the sump.

In the first sketch we see a few valves. These valves prevent the return of oil to the sump. This is extremely important after engine is turned off. If the oil during the time when engine is turned off drains completely from the system, it would cause the damages of bearings and other parts when engine is restarted. In fact, engine will run unlubricated until oil pump fills again the whole system with oil and reaches predicted pressure. We can also see control valve on the oil pump which will let out the excess oil due to excessive pressure.

In very expensive and maximally

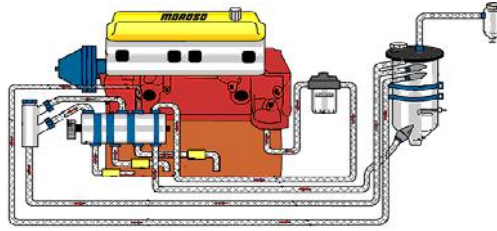

modified cars, sump as oil container is removed. Instead, a very shallow sump with a drain oil pump is installed. The pump takes oil from the engine in a separate container and returns it under the pressure into the engine. On the above drawing we see a schematic representation of such lubrication system with the pump driven by a toothed belt and a separate oil reservoir. This system is known as "dry sump".

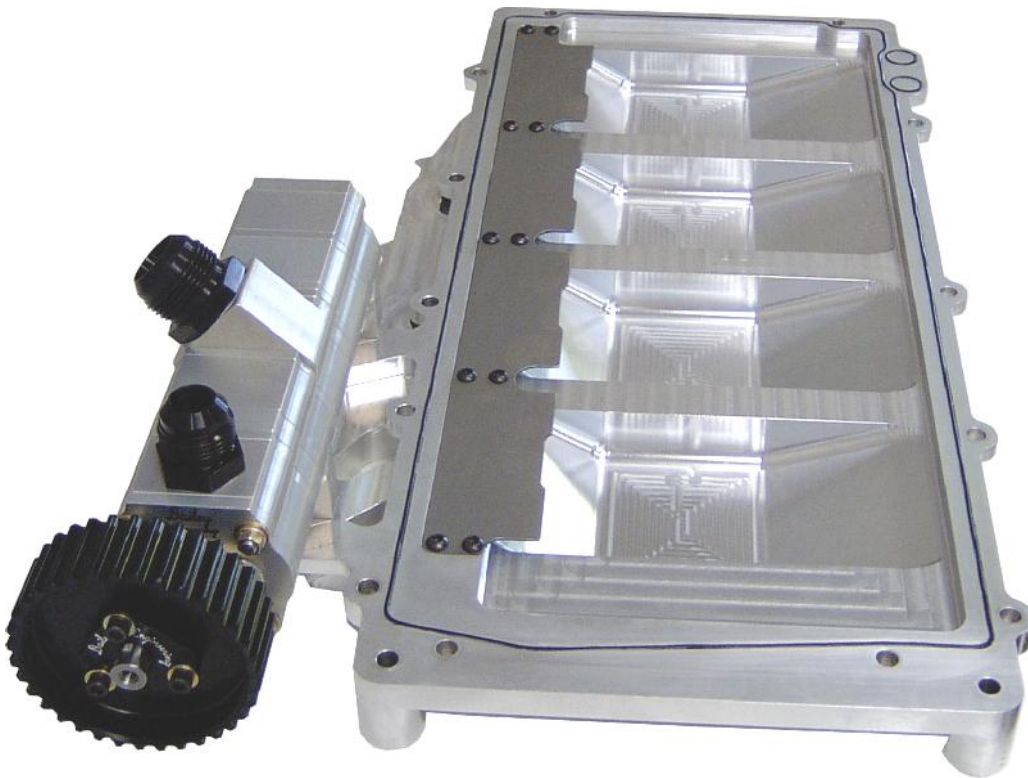

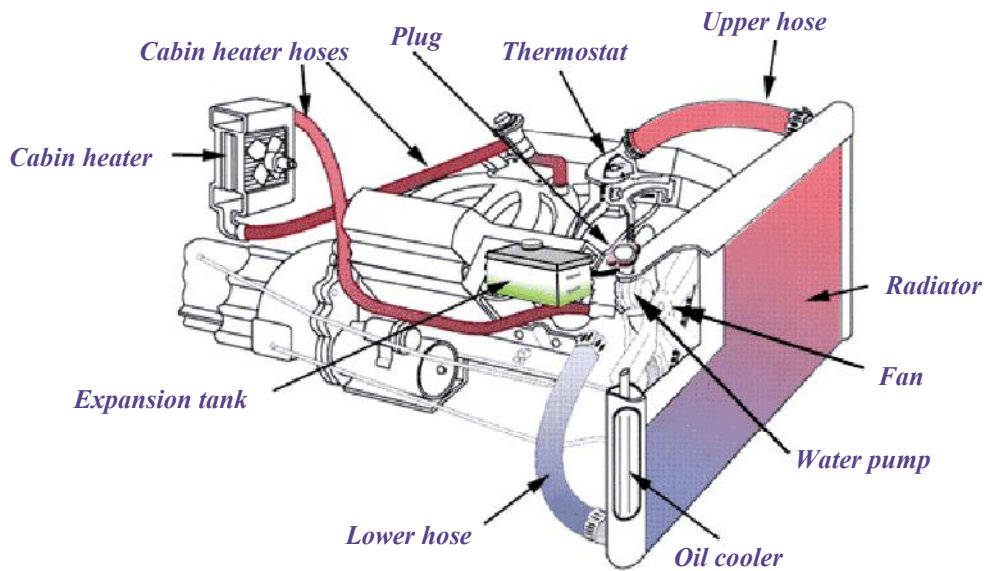

Engine cooling:

Water-cooled engine is developed by closed system of cooling fluid circulation through the engine block and head channels. The circulation of fluid from the engine through the cooler is regulated by a thermostat. During the engine warm-up, the thermostat is closed and the water circulates inside the engine. Heating the liquid to the upper limit of the engine operating temperature, the thermostat will open and leak the fluid into the circulation through engine radiator. Suppose that the engine operating temperature is 90°C , the thermostat will open at 92°C and close to 87°C . Continuously controlling the liquid flow through the cooler, the thermostat will maintain a constant coolant temperature.

The drawings show how after the thermostat opening, heated fluid flows through the upper hose to the

engine radiator. Circulating through the radiator cells and cooled by air, chilled liquid is returned through the lower hose back into the engine. Circulation of fluid allows water pump, located on the front of the engine and usually driven by V-belt. The pump draws fluid from the engine radiator and pushes it into the lower part of the engine. On its way to the upper radiator hose, the liquid is heated, cooling the warmest part of the engine.

At the top of the cooling system expansion tank is located. On this

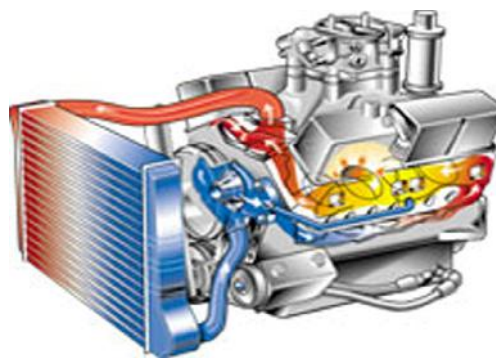

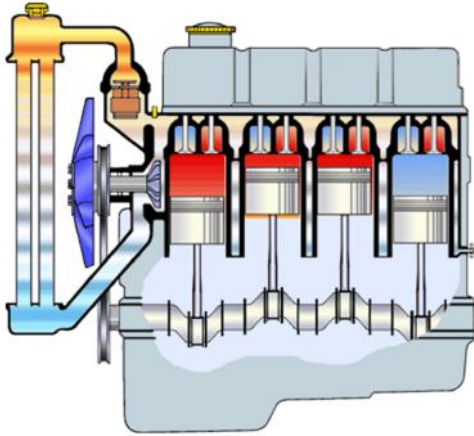

vessel we shall always find marking for maximum coolant level somewhere in the middle of it. Namely, the remaining space is used to absorb the expansion of liquid when heated. Therefore, we will find a warning: the system is pressurized, do not open. When heated, liquid expands and compress the air in the upper part of the vessel. By cooling, the liquid reduces its volume and pressure normalizes. Pressurized liquid in cooling system has a specific purpose. As we know, the boiling point of water is 100°C . However, if water is pressurized, its boiling point rises. If we use antifreeze, which has higher boiling point than water, we get a much higher boiling point than water has at atmospheric pressure. By increasing the boiling point we get the possibility of reducing the amount of coolant in the engine, and installation a smaller radiator. Small radiator allows modern low front design and other benefits.

During the driving, only the natural air flow through the radiator

cells is sufficient to cool the circulated fluid in the system. However, during the rest of the vehicle or in the city rush hour, the natural air flow is almost nonexistent. In such situations, the radiator would not be able to cool the liquid, and this would result with engine overheating. To assist the air flow a fan is installed in front of the radiator. This fan can be mounted on a water pump driven by a belt. However, this principle we will meet in older vehicles models. Disadvantage of this principle is slowing down the engine warming to its operating temperature, since the fan is constantly turning by the speed of water pump. The second and more common system is alike the first one, but with the use of bimetal clutch called **Visco fan**. In this case, the heart of the fan spins by speed of the water pump, while the fan fins are almost stationary and rotate just by inertia. During the heating bimetal expands and the fan heart will merge with fins and block them if necessary. This system is far more convenient, because it allows a faster engine warm-up and achieving sooner operating temperature. The cutaway of **Visco fan** is seen below.



The lower part of the fan is attached to the water pump, and its upper part to the plastic or aluminum fan fins. This system is also known under the name bimetal clutch.

But today the most commonly used cooling fan is powered by an electric motor (bottom photo). To



Thermostat

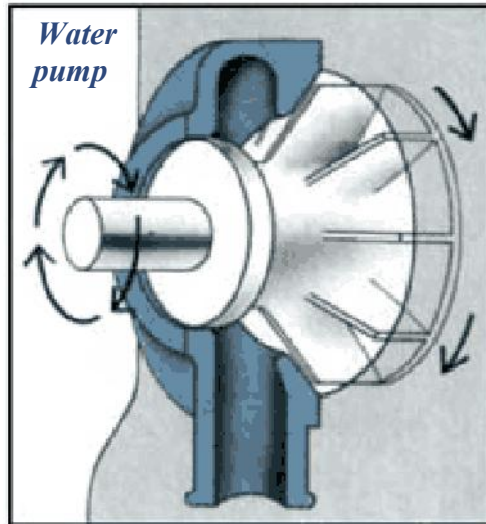

activate this fan, we need a thermal switch, which is installed on the engine radiator or cylinder head. By heating a thermal element with coolant to the specific temperature, contacts inside the element will get connected and the electrical circuit will close. Also, cooled thermal elements, will lead to separation of contact and open circuit. This simple principle of cooling fan works only as long as necessary to maintain engine working temperature and as such, very simple and practical, kept in use to this day.

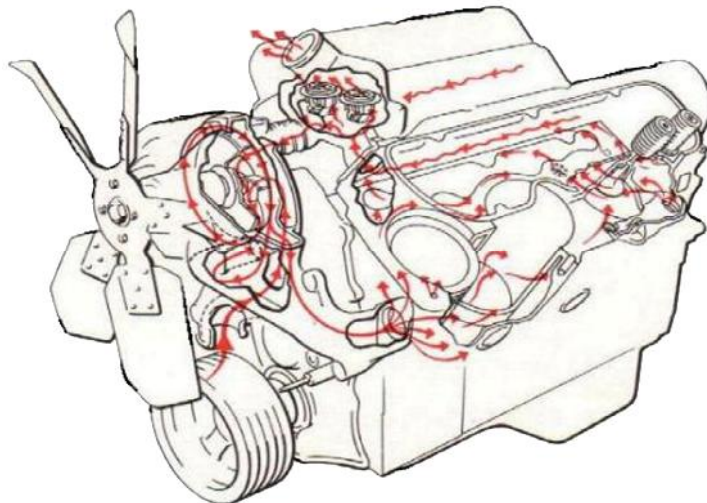

Engine coolant circulation

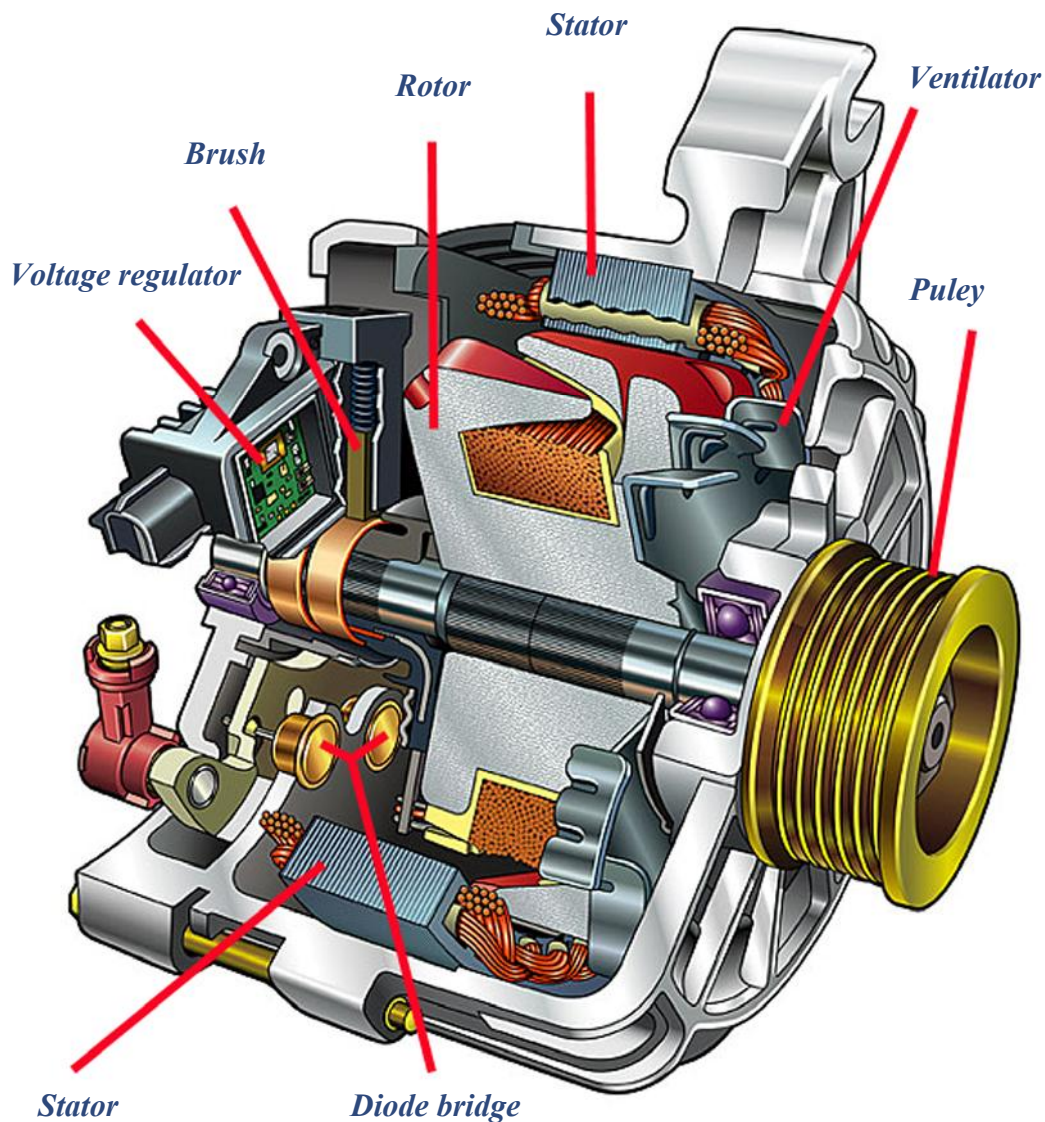

Alternator

Speaking in this book about the consumption of electrical energy to power electronic systems and other vehicle electrical consumers, let's say couple wards about electricity source. Everybody knows that electrical consumers are powered from the vehicle

battery. However, it is also known that battery has a capacity of energy and exhaustion time which depends of the number of involved electrical consumer. To prevent battery discharge a generator powered by car engine is installed to charge the battery. This generator is known as Alternator.

By the late sixties, automobiles were equipped with simple

dynamo generators, which generated direct current (**DC - Direct Current**). Unreliability and impracticality of such generator is mainly related to its dependence of engine revs.

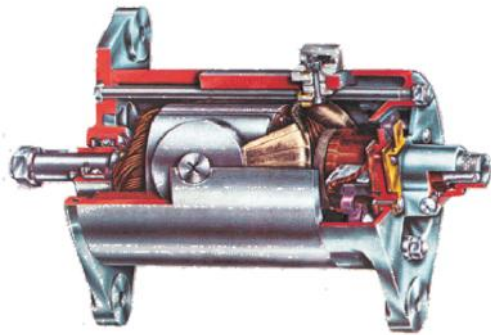

As shown in the above drawing, dynamo is the simplest form of generator. It consists of the stator, rotor and brushes. Voltage control was done by simple mechanical and often perishable regulator.

However, in the late seventies, dynamo was replaced by a very efficient and reliable alternator, whose work is controlled by electronic voltage regulator.

Unlike the dynamo, alternator generates alternating current (**AC - alternating current**), which is converted to **DC** by set of diodes. Alternator stator consists of three separate coils in the same housing and each coil occupies the 120 degrees of its surface. These three coils simultaneously create three separate generators of alternating current (three phases). Why three phases? Direct current (**DC**) mechanically converted from dynamo, was almost ideally balanced, while by diode rectified **AC**

current is very uneven, and pulsing. On the lower sketch we see a chart with an ideal **DC** voltage. Below that, the chart is drawn with **DC** impulses from one alternator coils. In order to obtain balanced and even voltage, three coils are used. In the third case we see how the three phases complement each other and form very balanced and even voltage.

Each coil uses two diodes to

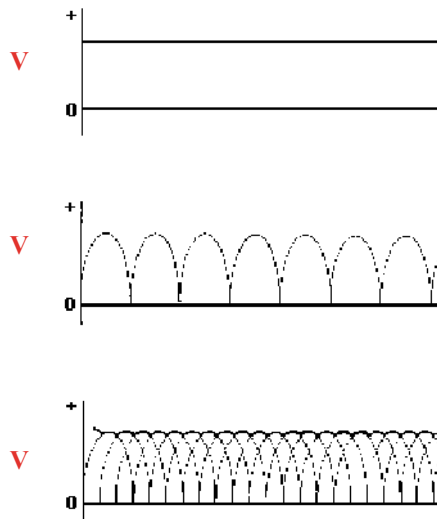

rectify the **AC** - alternating current to **DC** - direct current. Knowing that diodes function as valves which fail in one direction, it becomes clear how rectification from **AC** to **DC** is done.

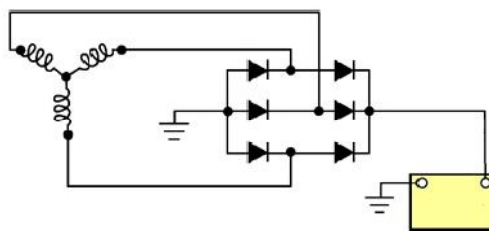

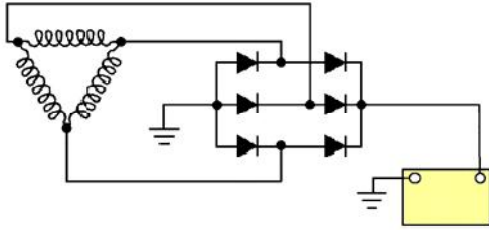

Diodes are usually located in the casing, known as: circuit diode, diode bridge or bridge rectifier (bottom photo).

On these schematic drawings are shown serial and parallel coils connections. In both cases, it is obvious that each coil is connected to a pair of diodes, from which we finally get the **DC** or direct current.

As we have said, each coil is using a pair of diodes, one positive and other negative. In fact, there are no positive or negative diodes, the point is how we turn them. Since diodes are working as one-way valves, one diode will only let pass the induction of negative impulses, and the other positive. On the following sketches we see how the diodes leak only positive impulses to the car battery.



Diode bridge



Rotor

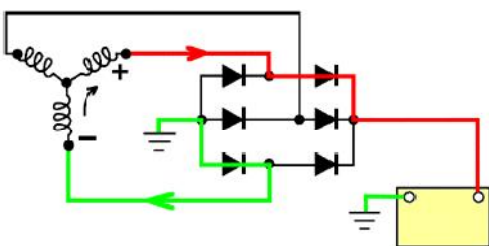
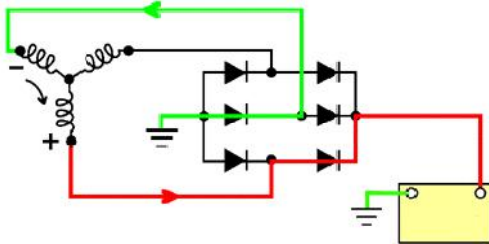

How the **AC** current is induced in coils? Rotor which also consists of metal core and coil rotates inside the stator. Coil is connected to sliding copper surfaces on which brushes are skating. Bringing electricity via brushes to rotor coil

a magnetic field is created. Alternating magnetic fields from the rotating rotor will induce an AC voltage in the stator coils. Induced voltage will depend of the strength of magnetic field, which is controlled by electricity brought on the rotor.



Stator

Last alternator component is an internal or external electronic voltage regulator. This controller monitors power consumption and



thus controls the battery charging. By increasing or reducing current supply to the rotor brush, the alternator output current is controlled.

In the bottom left photo the most common voltage regulator is shown. Such regulator is very practical as it has integrated brushes and is easy replaceable because it is fastened with only couple screws at the rear of the alternator (bottom photo).

Alternator cooling fan is fitted on the outside or inside.

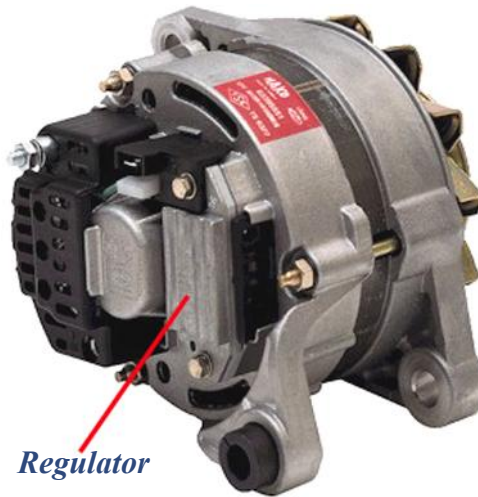

Regulator



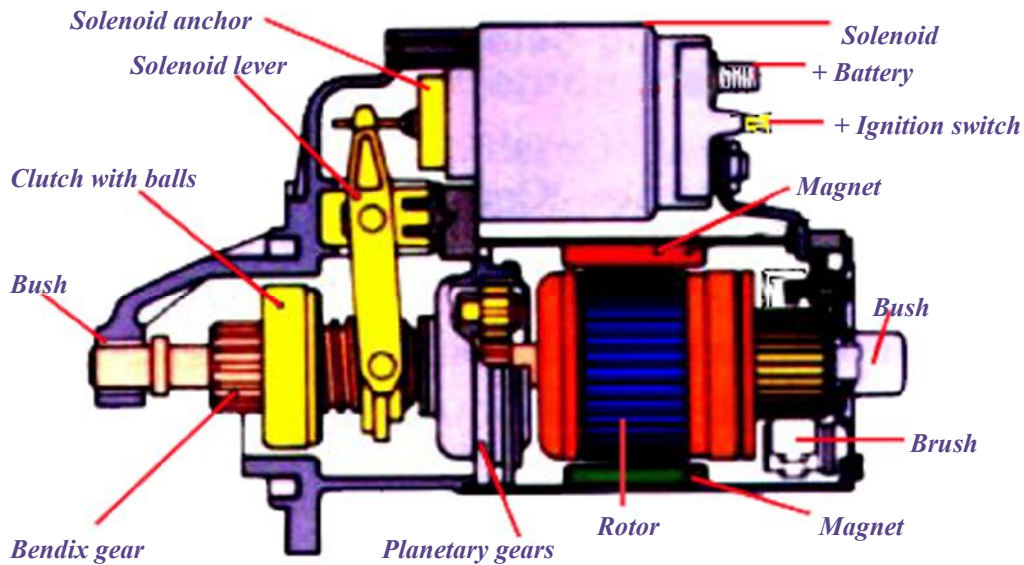

Starter motor

Electric starter motor is an electric motor powered by battery, which helps us to start the engine.

The upper drawing shows such a starter motor typical for today's vehicles, or a typical electric motor with permanent magnets. However, in practice it turned out that many people are not exactly sure how it works.

As we know, to start the electric motor, it is necessary to connect it to power supply. However, the sketch we see shows that electricity from battery does not come directly to the motor, but the solenoid above it. Therefore, let's see how the solenoid works.

Solenoid, or electromagnet, has two functions, coupling Bendix gear with the engine flywheel and connecting battery positive terminal with starter motor positive brush. As can be seen on both drawings, positive battery termi-

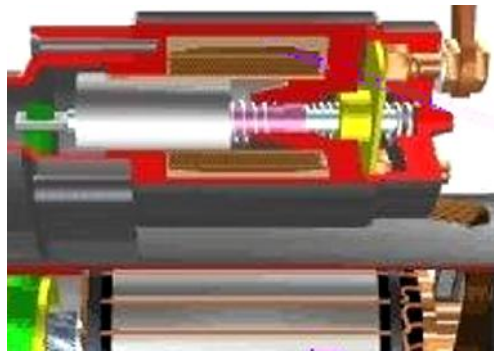

nal is connected directly to one of two very strong contacts on the solenoid. The other contact is associated with a positive brush in the electric motor. In standby mode, these two contacts are not connected. On third smaller solenoid terminal, current comes via relay which is activated by turning the ignition key in start position. This smaller positive terminal activates an electromagnet, which will pull the piston-shaped anchor in a cylindrical coil. Anchor will with its lower part pull the lever and couple the Bendix and flywheel gears and with its upper part connect heavy duty contacts on sole-

noid. Picturesquely described, anchor will push, in sketch highlighted in yellow, copper plate, which will connect the two contacts, and electric motor will spin until the moment when it is turned off by releasing the ignition key. By releasing the key from start position, we will disable starter relay and disconnect the electrical circuit, or deactivate solenoid. Deactivating the solenoid, the anchor is by spring returned to its original position, and with it the contact plate.

In next photo we see the **Bendix** gear in the position when starter



rests. It is logical and easy to conclude that it is not possible to turn on an electric starter before coupling these two gears. Accordingly, the anchor lever will first couple the starter and flywheel gear, and then connect the contacts and start the motor. But, this does not end up the story about starter **Bendix**. The moment when engine starts, engine speed will increase rapidly up to 1500 RPM, and sometimes higher. If starter stays coupled with a flywheel at that time, it would spin about ten times faster and will be completely destroyed. To prevent such situation, roller clutch is employed. This clutch works by blocking the rollers

between the shaft and gear housings. At the moment we start the electric starter, rollers will simply lock up in a conical space between the shaft and housing making **Bendix** gear and electric motor rotor a compact unit. In the moment when engine is started and begins to rotate with higher speed than starter, rollers will unblock as **Bendix** gear will start to spin in opposite direction, rotated by flywheel. Released from blockage, **Bendix** gear will return to its original position with help of spring and thread on which it slides back. In other words, even if we do not release the ignition key in time when engine starts, the starter will spin free, unconnected from flywheel, causing no damages.

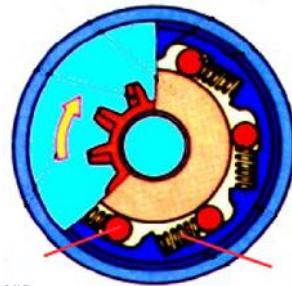

Rollers

Spring



XENON LIGHTS HID High Intensity Discharge



It is evident; as development of technology improves day after day we are finding new modifications on vehicles. A large portion of these modifications is focused on the passenger's safety in vehicles, and those outside them. So in addition to **ABS**, **ESC** and other safety systems, a great attention is given to good lighting on the road ahead.

Today more and more frequently vehicles are fitted with lighting system, popularly known as **Xenon** lights or **HID - High Intensity Discharge**. This system is completely different from the lighting systems installed in cars previously.

Whether it is a regular or halogen bulb, we are always talking about glowing wire which emits light. However, in the xenon bulb glowing wire does not exist, and light is emitted by compressed gas ignited by electric arc.



Xenon bulb consists of two electrodes and two casings which are made of quartz glass. The first layer is filled with a mixture of noble gases at high pressure, in which xenon is included. The second layer has protective nature.

Compressed gas ignites due to the high-voltage arc occurrence between two electrodes. Arc volta-

ge at the initial stage igniting cold bulb is about 21,000 V Xenon gas will be first heated to a temperature of light radiation, and thus provide immediate illumination, which is usually in the beginning, a bluish colour. When gas is fully heated, radiant light will take the other gases with small additions of mercury and metal salts. After a full warm-up, the bulb will glow white light, and the voltage on the arc between the electrodes will significantly drop and become constant. From this description of the xenon bulb may be concluded that it is not possible to test it by connecting it to the battery, as it is the case with regular or halogen bulbs. Therefore, before making any bulb defect conclusion, it is necessary to pay attention to other elements of the HID system. If only one bulb on the car does not work, the simplest is to switch the bulbs from one headlight to another, just for a test. If switched bulb does not work on the headlight which worked before, we can conclude defective bulbs. If switched bulb does work, we can conclude a malfunction of the so-called ballast or starter. Starter can be incorporated into the ballast housing, or may be a separate element.

So we have come to the other two components of the xenon lights. Starter will ensure high arc on first gas ignition, while the ballast, inverter at the same time, will convert DC to AC power and regulate the frequency, which ranges from 250-400 Hz.

112

Inverter



In the above photo we see one such ballast-inverter, which has built-in starter.

Due to the configuration of HID elements, a light bulbs have different tags. D1S will mean a clean or naked light bulb with an integrated starter. D2S label will bare plain bulb. D1R will have the same characteristics as the D2R, but will have an integrated starter. And finally, D2R is naked light bulb with black shading for directing the light beam.

HID lighting is characterized by up to three times greater light intensity and lower power consumption in comparison with halogen lights.

When replacing the halogen lighting with xenon lights, it is advisable to change entire headlight for correct light direction.



XENON headlight with nverter

Safety Air Bags

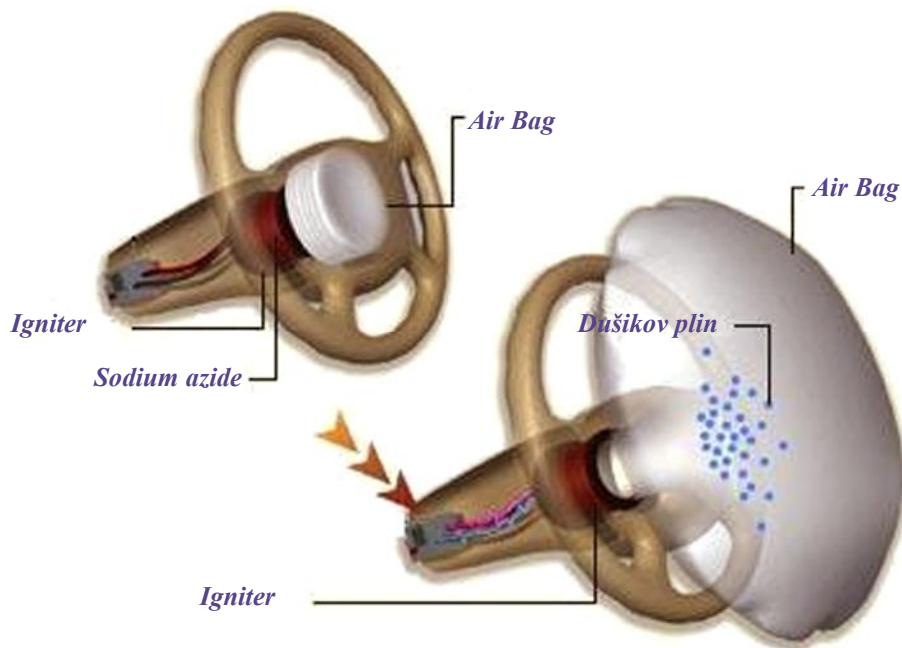

The airbag is made of very thin nylon cloth and packed in the central part of the steering wheel, and in newer and more expensive vehicles we will find them in doors, seats, etc.

As before, the sensor is the one who will give a signal to the module or control unit (computer) which manages the system and activates the airbags. Sensors which activate air bag will trigger the activation of the airbag during vehicle collision in the solid object with a speed of 15-25 km per hour.

In older types of vehicles, mechanical switch located on the front

of the vehicle or on the side, will close the circuit and thus give a signal to module for activation of certain air bag. The module will trigger the airbag on the way that it closes the circuit on the air bag igniter, causing a spark occurrence. Spark will cause a chemical reaction of sodium azide (NaN_3) and potassium nitrate (KNO_3), which will transform in nitrogen gas, and will in one quarter of a second or with a speed of approximately 320 kilometres per hour, fill the airbag with gas. Immediately after air bag activation, the filtered gas will exit from it trough porous cloth



of which it is made, to free the passengers and allow them to move out of the vehicle. Airbag activation is usually accompanied by white powder. It is a powder which is used in air bag packaging, and serves as a lubricant during bag unwinding.

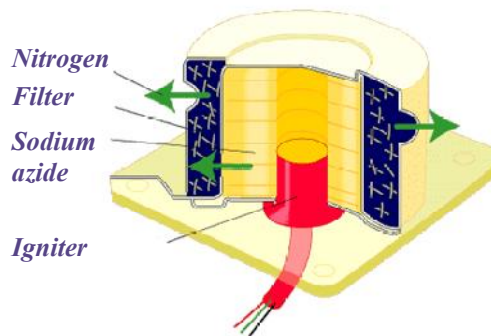
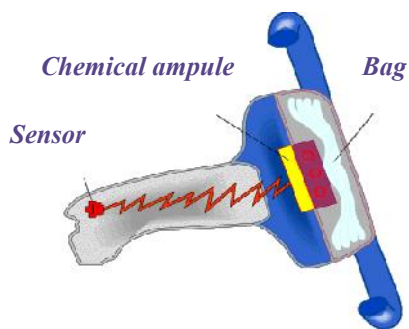
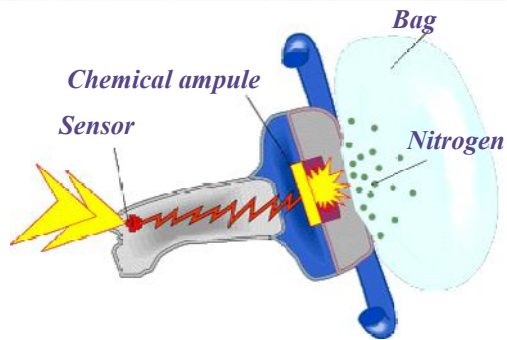

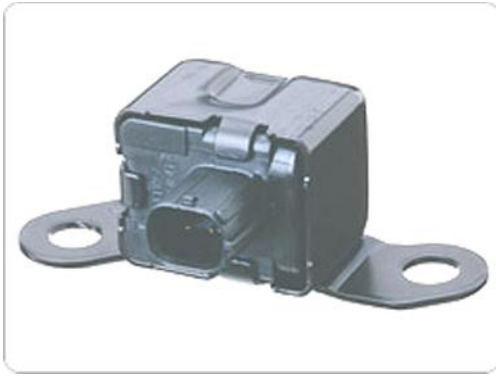

In the above photo we see an electromechanical sensor, which is placed at the front of the car. The sensor operates on the principle of rotor which connects the contacts when punched, and closes the circuit. These sensors are adjustable, with adjustable sensitivity.



This photograph shows a fully electronic sensor known as Micro-accelerometer. These sensors measure acceleration, deceleration and sudden deceleration, which is registered as a shock. Of course, such a sensor has the ability to recognize a slowdown, and the type of shock which can be caused by sudden braking, hitting the pavement etc. Electronic circuit which was

previously programmed to perform the various functions, will recognize the impact and its strength and send a signal to the



module.

Airbag module we shall often meet by name ECU. However, unlike engine computer which is known under the same name, this is the abbreviation of **Electronic Control Unit**.

Air Bag ECU or the air bag control unit has a function to recognize signals from sensors distributed on the car and activate the appropriate air bag. It also checks the sensor signals and determines whether a signal is caused by sudden braking, hitting the pavement etc. Only after checking the signal, **ECU** will activate the air bag. The module also prevents the possibility of getting false signals from other sources, such as the influence of some external stress and similar. This computer will also regulate automatic belt tensioning during vehicle collisions, and will alert a possible malfunction of a particular sensor.

ABS

Anti-lock Braking System

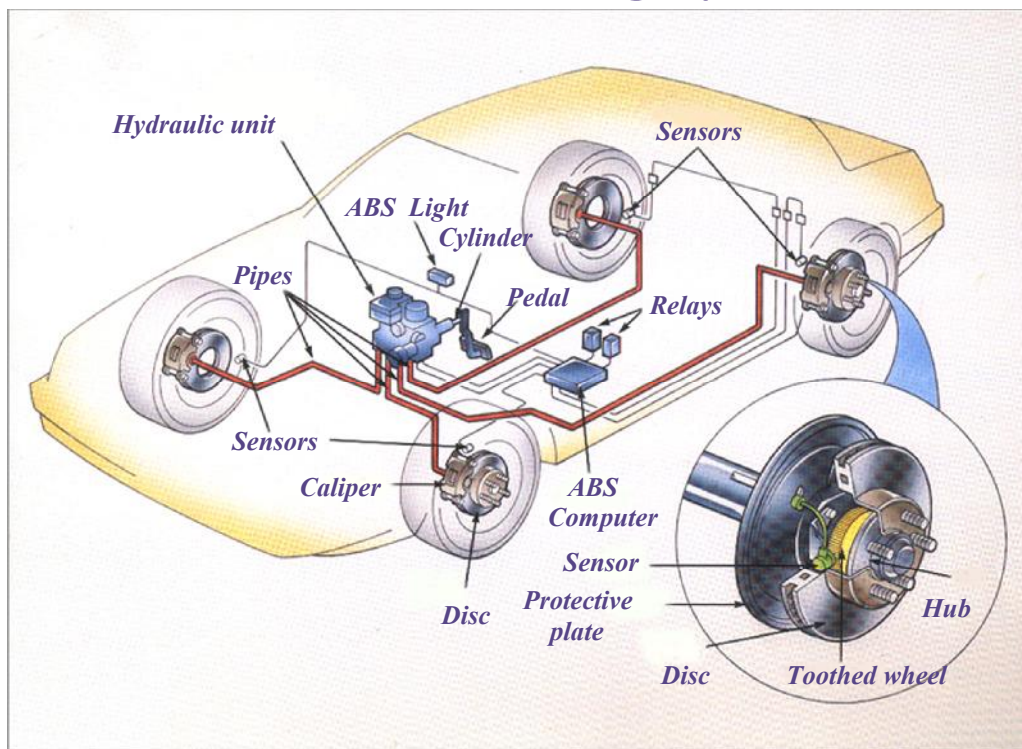

Function of the **Anti-lock Braking System** is to prevent wheels from blocking during sudden braking. Disabling brakes locking, car drivers will be able to steer and when braking strongly, without drift. Just the possibility of sudden braking without fear of wheel blocking, will shorten the stopping distance in relation to repeated braking, which was usually practiced in such situations. In addition, **ABS** also provides electronic control of vehicle stability.

Disadvantage of **ABS** is longer braking distance in certain situations, as well as driver's overconfidence in this system when u-

sing brakes in various situations.

ABS system consists of a central unit (computer), four sensors (one on each wheel) and two or more valves in the hydraulic circuit.

During driving, computer continuously records the rotation of each wheel and calculates wheel speed on the base on the sensor pulses. If during the braking, deceleration occurs on the one of the wheels to such extent that there is a possibility of blocking, computer will through the valve reduce the oil pressure to that wheel and prevent blocking. When the same wheel achieves greater speed in comparison with other wheels due



to a low oil pressure, computer will again let the oil to this wheel at higher pressure. This operation computer is able to repeat up to twenty times per second. Oil pressure oscillation on wheels can be manifested as slight brake pedal pulsation.

When programming computer, far more data will be taken in consideration than just a wheel speed, and will be used in calculations of oil pressure on individual wheel. Specifically, on a slippery surface wheel speed is reduced much faster than on the dry surface. On a dry surface, much greater oil pressure will be required to stop the vehicle or lock the brakes. However, on a slippery surface, very little pressure will cause wheels blocking and skidding. Simplified, the tire will in firm

contact with the dry surface, try to stop the vehicle. However, on the slippery surface, in an effort to stop the vehicle, the wheel will simply block, having not resistance which tire has in contact with dry surface. Computers will also recognize the nuances of the slower inner wheels turning when vehicle describes the circle entering a curve.



ABS sensor

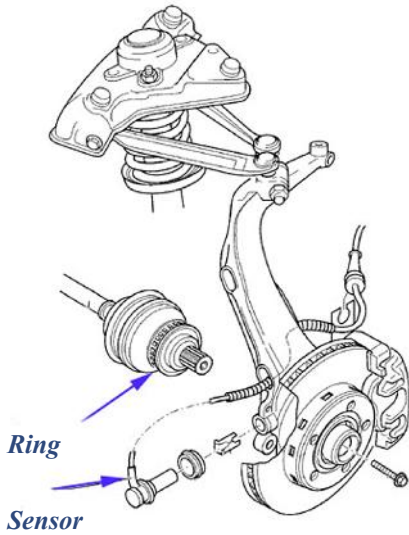

ABS sensors are working as electromagnetic generators, or on the same way as previously described **CKP** crankshaft sensor. Toothed rings are attached on the drive shaft or on the wheel discs, while the sensor is attached to the wheel hub (upper sketch).

Sensors and toothed rings are constantly exposed to dirt from the roadway, as well as to the metal chips from brake discs. Deposits of dirt, mixed with fine metal particles, will certainly affect the sensor signals, and thus the computer calculations. It is needless to mention

what are the consequences of incorrect computer calculations. Described problem, we can see in the bottom photo.



By monitoring the sensor signals, computer knows in every moment how the brakes work on each wheel. After calculation, computer sends commands to electromagnetic valves in the **ABS** hydraulic controller unit.

In hydraulic assembly, usually are built four valves, one for each

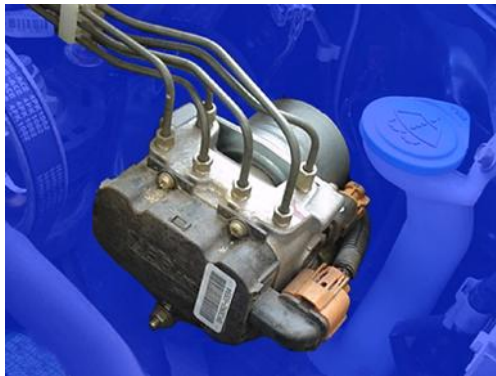

wheel. The valve has three operational stages. In the first stage, the valve is open and enables the oil flow under the pressure from the brake master cylinder to the wheel. In the second stage, the valve blocks the oil passage, regulating the oil pressure due to the further pressure on the brake pedal. In the third stage, the valve releases the pressurized oil from the wheel.

Since the system is able to relieve the oil pressure from each wheel, there must be a way to get it back when needed. For this purpose electric pump is installed in hydraulic control unit. Pump will return pressurized oil in the wheel brake cylinder by computer's order.

Traction control:

ATC (Automatic Traction Control) and **DTC (Dynamic Traction Control)** is one of the names for the vehicle traction control, and is mainly linked to the **ABS**. Traction control is extremely important in high-performance vehicles, to prevent vehicle skidding by sudden acceleration and wheel slip on the road when rapidly starting the vehicle. More expensive vehicles have possibilities of electronically locking clutch on one or the other side of differential, automatically reducing engine **RPM**, ignition retarding, opening the turbine bypass valve, etc. However, one of the cheaper solutions to control tracking is slowing down one or

two wheels before slipping or drift occurs. Slowing down one or two wheels brings us into close relationship with **ABS**. **ATC** computer is associated with the engine **ECU** and with **ABS**. In combination with previously mentioned acts of the engine computer, **ATC** will give the command to **ABS** computer to increase the oil pressure at individual wheel, what will result in slowing down particular wheel, or synchronizing its speed of rotation with the other drive wheel, or wheels on **4WD**.

Today, electronically controlled steering is developing faster than ever. Thus, on the newer and more expensive vehicles we often meet the **ESC (Electronic Stability Control)**. However, it always comes down to a restrictions of engine performances at the right moment, and the slowing effect of individual wheel by **ABS**. Surely, the new systems are using more sensors, to monitor various situations and vehicle behaviour on the road. Thus, even gyroscopes are used today to measure the wheel tilt and strain. Computerisation of all vehicle systems mainly depends of sensor data quantities.

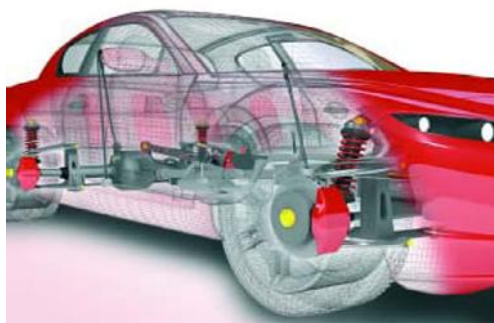

OBD II/SAE ACRONYMS

ABS	Antilock brake system
A/C	Air conditioning
AC	Air cleaner
AIR	Secondary air injection
A/T	Automatic transmission or transaxle
SAP	Accelerator pedal
B+	Battery positive voltage
BARO	Barometric pressure
CAC	Charge air cooler
CFI	Continuous fuel injection
CL	Closed loop
CKP	Crankshaft position sensor
CKP REF	Crankshaft reference
CMP	Camshaft position sensor
CMP REF	Camshaft reference
CO	Carbon monoxide
CO2	Carbon dioxide
CPP	Clutch pedal position
CTOX	Continuous trap oxidizer
CTP	Closed throttle position
DEPS	Digital engine position sensor
DFCO	Decel fuel cut-off mode
DFI	Direct fuel injection
DLC	Data link connector
DTC	Diagnostic trouble code
DTM	Diagnostic test mode
EBCM	Electronic brake control module
EBTCM	Electronic brake traction control module
EC	Engine control
ECM	Engine control module
ECL	Engine coolant level
ECT	Engine coolant temperature
EEPROM	Electrically erasable programmable read only memory
EFE	Early fuel evaporation
EGR	Exhaust gas recirculation

EGRT	EGR temperature
EI	Electronic ignition
EM	Engine modification
EPROM	Erasable programmable read only memory
EVAP	Evaporative emission system
FC	Fan control
EEPROM	Flash electrically erasable programmable read only memory
FF	Flexible fuel
FP	Fuel pump
FPROM	Flash erasable programmable read only memory
FT	Fuel trim
FTP	Federal test procedure
GCM	Governor control module
GEN	Generator
GND	Ground
H2O	Water
HO2S	Heated oxygen sensor
HO2S1	Upstream heated oxygen sensor
HO2S2	Up or downstream heated oxygen sensor
HO2S3	Downstream heated oxygen sensor
HC	Hydrocarbon
HVS	High voltage switch
HVAC	Heating ventilation and air conditioning system
IA	Intake air
IAC	Idle air control
IAT	Intake air temperature
IC	Ignition control circuit
ICM	Ignition control module
IFI	Indirect fuel injection
IFS	Inertia fuel shutoff
I/M	Inspection/maintenance
IPC	Instrument panel cluster
ISC	Idle speed control
KOEC	Key on, engine cranking

KOEO	Key on, engine off
KOER	Key on, engine running
KS	Knock sensor
KSM	Knock sensor module
LTFT	Long term fuel trim
MAF	Mass airflow sensor
MAP	Manifold absolute pressure sensor
MC	Mixture control
MDP	Manifold differential pressure
MFI	Multiport fuel injection
MIL	Malfunction indicator lamp
MPH	Miles per hour
MST	Manifold surface temperature
MVZ	Manifold vacuum zone
NVRAM	Nonvolatile random access memory
NOX	Oxides of nitrogen
O2S	Oxygen sensor
OBD	Onboard diagnostics
OBD I	Onboard diagnostics generation one
OBD II	Onboard diagnostics, second generation
OC	Oxidation catalyst
ODM	Output device monitor
OL	Open loop
OSC	Oxygen sensor storage
PAIR	Pulsed secondary air injection
PCM	Powertrain control module
PCV	Positive crankcase ventilation
PNP	Park/neutral switch
PROM	Program read only memory
PSA	Pressure switch assembly
PSP	Power steering pressure
PTOX	Periodic trap oxidizer
RAM	Random access memory
RM	Relay module
ROM	Read only memory

RPM	Revolutions per minute
SC	Supercharger
SCB	Supercharger bypass
SDM	Sensing diagnostic mode
SFI	Sequential fuel injection
SRI	Service reminder indicator
SRT	System readiness test
STFT	Short term fuel trim
TB	Throttle body
TBI	Throttle body injection
TC	Turbocharger
TCC	Torque converter clutch
TCM	Transmission or transaxle control module
TFP	Throttle fluid pressure
TP	Throttle position
TPS	Throttle position sensor
TVV	Thermal vacuum valve
TWC	Three way catalyst
TWC+OC	Three way + oxidation catalytic converter
VAF	Volume airflow
VCM	Vehicle control module
VR	Voltage regulator
VS	Vehicle sensor
VSS	Vehicle speed sensor
WU-TWC	Warm up three way catalytic converter
WOT	Wide open throttle

DIAGNOSTIC ADVISOR



This advisor is for beginners, hobbyists and enthusiasts, and I believe will be of benefit to professionals, as a reminder. Description of the potential problems related to vehicle malfunctions is based on the most common questions related to failures.

First and most common question is related to problems with engine starting. Considering that number of causes can be related to this problem, a diagnostic sequence is necessary to be set up in order. So, let's start with some examples, referring to the most banal possibilities of engine breakdown.

In the following chapter, engines with carburetors will have a label (c), for carburator. Engines with direct fuel injection (i) for injection and diesel engines (d).

Lack of electric power

Empty battery due to the lights left on, or other electric customer which is not automatically switched off by extracting ignition key from steering wheel lock.

Another possibility is broken electrical circuit due to the accumulated oxidation, between battery

terminals and cables connectors on them. A common situation is that problem is not solved by cleaning oxidation on these elements as oxidation is hidden inside the terminal connectors where they are joined with power cables. In such case, it is advisable to use jump start cables and connect the negative battery terminal with clean metal engine part, and the positive terminal with a clean part of positive battery cable. If the electric circuit is achieved, battery terminals connectors have to be replaced.

Ignition lights on, but engine will not start

There are two situations in this case. In first situation we have all control lights on when the ignition is turned on, but the lights go off when we try to start the engine. Here we may have a problem with partially empty battery, or oxidation as previously described, but in lesser extent. In fact, now we have a partial flow of current through the oxidized terminals, but not enough to run the starter

motor. Let's do the same procedure of oxidation removal as in the previous case, and the problem should be solved. If this procedure does not give a positive result, we should look for problem in starter motor.

Another situation is; the control lights are lit, starter does not respond to turning the key, but lights at that moment do not lose intensity. In this case, there is a possibility of defective ignition switch or starter motor. To find out what it is, we will make the next check. With a piece of insulated wire we will bring electricity from positive battery terminal directly to a small contact on the starter solenoid. If the starter motor begins to rotate, the problem lies in the ignition switch, which has the same task that we have just done by jumping it. If the starter does not respond to the test described, it should be serviced.

In the third situation, the lights are lit, starter motor turns but the engine will not start. In these cases some of us will try to start the engine by pushing the car. If such a process helps to start the engine, we can conclude that ignition switch is defective. How to check the switch? Put the transmission in neutral position. Switch on ignition, and with a piece of wire repeat the previous procedure connecting the battery with starter. If the engine starts, we have defective ignition switch. Of course, this last situation applies to gasoline engines because on diesel vehicles a similar

situation may be caused by defective glow plugs.

With described test we can check the correctness of the circuit on starter and ignition switch in other suspicious situations when starting the engine. Such situations can be manifested by starter clicking in attempt to start the engine or when starter turns engine with difficulties. In any case, before deciding to change the ignition switch or repair the starter, it is advisable to perform described tests.



Accumulated oxidation is simply melted with hot water. After such a quick and simple procedure, the contacts need to be cleaned with sandpaper and greased.

The engine turns but will not start.

Of course, in such a case we shall perform previously described test. However, if test does not help, it is necessary to take further steps.

Surely, the easiest way is to connect the diagnostic device, allowing the computer to search for error. But usually not all of us have such opportunities. Moreover, even this magic machine is not always helpful. Yet this is just a machine with limited capabilities. So, sometimes we come across a situation that scanner shows no diagnostic error and engine will not start or running uneven. In such situations, we need a person with quite a lot of knowledge and experience.

But let's go back to our next step where we are going to make quick test by eliminating possible problem causes. Firstly we shall check whether we have the spark on the spark plugs. Such test is done by pulling out the high tension lead from spark plug and bringing its end close to engine metal part (ground). In attempt to start the engine, spark should appear between the lead and ground. If spark does not appear, we should look for possible cause. In the case of ignition system with contact breaker, the principle is explained in this book. When transistor ignition is installed, malfunctioning is mostly related to the Pick-up (coil) in the distributor or module. Some of us will be able to test these components with instrument, others will use scanner to locate the error. In any case, we should not neglect checking ignition coil, distributor cap, rotor and spark plug cables, which are very often the cause of the loss of voltage on the spark plugs.

If we have concluded by testing electrical components that problem does

not lie in lack of spark on the spark plugs, we shall focus on fuel supply system. In this book we have also discussed about the fuel supply, therefore let's jump straight to the test. In (c) engine with mechanical fuel pump we can test the fuel pressure during the engine starting attempt. If we do not have the pressure gauge, just checking the fuel pressure by finger on disconnected fuel pipe will give us a rough idea how good is the fuel supply to the carburator.

On (i) engine we shall find electric fuel pump. When ignition is switched on, we should hear a slight buzzing for about 2-3 seconds. If we do not hear buzzing, electrical circuit on the pump has to be checked. If the circuit is broken problem may lie in the pump relay or fuse. Pump can be checked by connecting it directly to battery with external wires. With these tests we'll see if we are talking about the problem of fuel supply, or whether we have a problem with electricity circuit on spark plugs and what is the cause of it. These are the most common problems associated with the engine starting troubles.

In the (i) engines we may have the case that there is no spark at the spark plugs nor injectors are working. Although we previously check the fuel pump, spark plugs are still dry. This case indicates a problem with the CKP sensor. Namely, if the sensor is faulty, the ECU has no information of crankshaft position, and so can not determine the moment of ignition and fuel injection. In such a case, it is necessary to check the resistance of the sensor (about 300Ω).

What are the vehicles of newer production, it is increasingly difficult to find the fault without a diagnostic device. However, these few tips related

to engine starting problems are easily applicable and usually solve this problem in 80% of cases.

On diesel vehicles, the engine starting problem is usually related to defective glow plugs. In older types of cars we do not have glow plugs MIL, so we do not know whether they work or not. In parallel connected heaters may happen that only two or three heaters are in order. In such case the engine will start working with only two or three cylinders, which will result in severe engine vibration and black smoke from exhaust. On engines where heating elements are connected in a series, will operate all or none. Certainly in this case we can not expect to start the engine even as described in the first case.

One of banal causes related to engine starting problem, loss of power, poor acceleration, etc. is clogged fuel filter. On some vehicle models, beside large fuel filters, small net filters are installed too and are mostly hidden in carburetor or pump housings. Therefore, if we do not have certain malfunctioning data of particular mechanical or electronic engine element, it is advisable to replace the fuel filters and check all electrical connections as well as make the other small routine check-ups which are often ignored.

Increased fuel consumption

Increased fuel consumption and trembling engine does not necessarily indicate a worn out engine or other elements. On the contrary, most often relatively simple actions solve the problem.

In (c) engine, a common cause is reduced contact breaker gap, which will cause a voltage drop across the spark plugs and incorrect ignition timing. Incorrect fuel level will cause fuel spill over in the carburetor venturi. Clogged diffuser will prevent air-fuel mixing, causing too rich mixture. Thus, proper and skilful servicing will bring the engine in harmony and proper functioning during its lifetime.

In (i) engine, it is necessary to take into account the irregularity of the lambda probe, and worn out timing belt or chain. In addition, the greatest cause of increased consumption is a poor condition of the air filter. Specifically, the opinion about air filter condition is often made on the basis of mileage, which is not reliable. Namely, urban driving condition behind other vehicles, whose exhaust



pipes are pointed directly at the vehicle behind will clog the porous filter structure far earlier than it is scheduled by maintenance intervals. Furthermore, when checking the air filter condition, it is not uncommon to inspect filter from the wrong side. Namely, taking the air filter cover off, clean filter structure is usually found as we see the side from which filtered air is sucked by engine.

In the lower photo we see the filter from its clean side and clogging on the opposite side, where all dirt remains. In addition, first image shows oily stain from engine breather which is connected to air filter. This stain occupies about 20% of filter surface and reduces air flow.



Erratic idling

Erratic idling may be the result of series failures in the engine electronic elements. However, such problems are usually solved by diagnostic device, but there are situations where diagnostic scanner won't help much. As already said, the diagnostic machine is very limited, and its diagnosis has been narrowed to the electronic part of the car. Although such a machine can perform in a few seconds more mathematical operations than the human in his whole life, they are still not able to think.

In other words, diagnostic machine did not registered error in engine electronic system, but we are not satisfied with engine idling. So, let's get started, as we say in the jargon, by foot.

Erratic operation at idle is usually a result of uneven compression ratio in one engine cylinders. The lower compression ratio will result with a weaker down force in the expansion stroke, and thus disrupt the engine balance. We will get the same effect if one cylinder receives a weaker mixture than others. But let's start from the first case, the lack of compression. The first part of test we will do by disconnecting cylinders one by one, in order to determine which of them needs attention. When engine is at idle, we shall remove high-voltage lead and see if there is any difference in engine rhythm. The same procedure we will repeat on other engine

cylinders. If we notice a slight or no change in engine idling with disconnected **HT** lead from spark plug on one cylinder, we found the cause of the problem. The next step will be to measure the compression on all engine cylinders. The measurement should show the same compression value in all cylinders except one which did not respond to disconnected **HT** lead. On this cylinder compression ratio will be lower for 25-50% than on the others. There are two possible causes of poor compression in one of the cylinders. First, too small or no gap between the valve and lifter. Second, burnt exhaust valve. The first variant is more frequently the case, and can refer to more than one cylinder. The problem is solved by adjusting the valve clearance (not hydraulic). If after adjustment we receive a satisfactory compression ratio measurement value, the problem is solved. Otherwise, problem is most probably related with burned valve, which needs to be replaced. When we have the case of the burned valve, fussy engine is manifested only at idle. With increased engine **RPM**, valve omission is almost negligible, and engine picks up the even operating rhythm.

The same effect we get due to the failure of air intake to the engine manifolds. This usually happens due to the worn out hose of vacuum brake servo unit. Of course, in this case, the value of compression ratio will be satisfactory, while diluted mixture will cause loss of

power at engine idling.



Compression tester, one of the cheaper and simpler but functional gauges.

Valve knocking - cold engine

Rattling or clanging valves sound is quite well known. On older vehicles models that was handled by adjusting the valve clearance, either by bolts and nuts or by replacing the shims on the valve tappets. However, the engine with hydraulic valve tappets, rattling sound occurs only when engine is cold or if we leave it for a while, say an hour or two. For those who just have not fully mastered the principle of the hydraulic valve lifter, the interpretation of this phenomenon is controversial. What exactly is this?

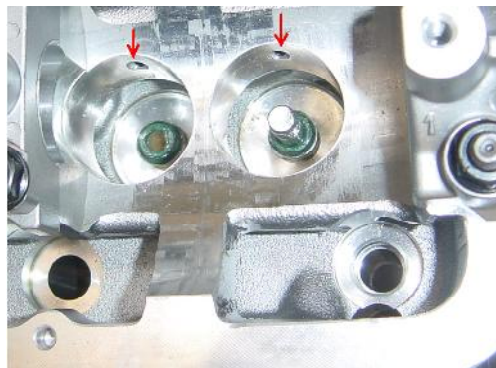
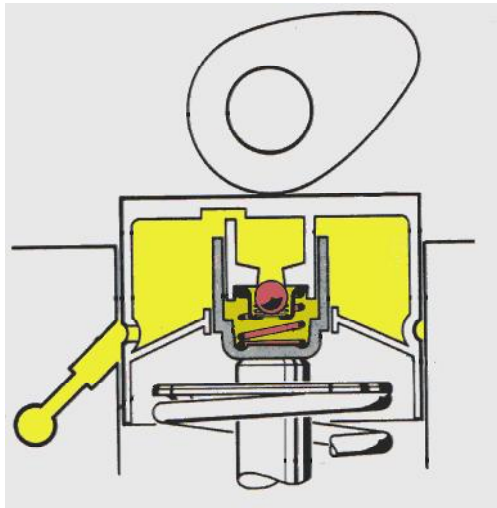

Hydraulic valve lifters replaced old valve lifting systems, which often had to be adjusted, either by unscrewing and screwing adjusters or exchanging the shims. In addition to simplification of maintenance, this modification eliminated the least sound of valves that have occurred due to improper clearance between the valves and camshaft.

Hydraulic lifter is very simple but very precise device. It consists of cup, piston, valve in the form of ball and spring. As shown in the sketch and photographs, a cup is closed on the bottom and has cylindrical hole in the middle. The small piston is inserted in the hole, which stroke is about three millimetres. Through a small hole on the side of the cup enters the engine oil under the pressure. Oil will, due to the pressure, compress the ball valve and enter to the central area of the piston and push it down. When pressure is equalized in both chambers, the ball will close the passage under the spring pressure. The eccentric part of camshaft will push lifter down together with valve which is supported by tappet piston. Ball which has the role of the valve due to oil pressure from the piston chamber, will completely prevent the return of oil in the cup chamber, so the cup and piston will become one compact unit.

Returning to its upper position, the cup again encountering the oil port on cylinder head, and the charging piston chamber with oil continues. In other words, whenever a cup comes in its upper position, free from the thrust of the camshaft, the chamber will be supplemented with oil, until cup merges with camshaft and tappet piston with valve. With this system, we eliminated even the smallest clearance between the valves and camshaft.

But why tappets rattle?

When engine is turned off, several camshaft lobes will be in position compressing the engine valves. Of course, in such a position compressed oil from the piston chamber tries to escape in the tappet. When hydraulic tappet is in good condition that will not be possible because the ball closes the passage. However, if the ball or its seat is damaged, the oil will escape over time from the piston chamber. Until next engine start the clearance will be formed between the camshaft and tappet. This gap will depend of the amount of escaped oil. So, after starting the engine, we'll hear clanging one or more tappets, until the chamber is filled with oil again. In addition to damaged ball valve, cause of oil leakage may be carbon deposit on ball or its seat as a consequence of poor oil quality. On sophisticated engines, where changing tappets is complicated and expensive procedure, it is worth trying to flash the engine with new oil about three times during specified oil change interval in order to wash out concentrated carbon inside the tappets. However, if special and cheaper flashing oils are used we have to be aware of its inadequate lubrication capabilities and therefore special care have to be taken when running engine.

Increased oil consumption

When oil consumption is increased, the most common diagnose is: worn out engine. Such a diagnosis

can be justified and not. In any case, before making a final conclusion, it is necessary to make a few tests on the engine.

The engine may have increased oil consumption, due to two problems. The first is valve seals wear, and a second worn out piston rings. In worse cases pistons and pistons skirts can be worn out too what makes repair very expensive. Therefore, it is necessary to set the correct diagnose. In most cases, technicians will come to the conclusion on the base of compression ratio. Measuring the engine compression is not relevant data about piston and piston rings condition. Namely, oiled piston rings will seal well enough to show higher compression ratio than predicted for that engine. This fact is understandable. Suppose that engine valves are closing satisfactorily. By turning the electric starter motor (starter), the pistons will act as a compressor. With well oiled piston rings, compression ratio will be more than satisfactory. However, the situation changes when it comes to the expansion of fuel-air mixture. At this point, the pressure of burning mixture, which pushes the pistons, is far larger than compressed air in the compression measurements. At such high pressure in expansion stroke, gasses will leak between worn piston rings and piston skirts to cylinder block. The amount of leaked gasses will depend of the piston rings conditions and their elasticity.

Certainly, worn piston rings and

lack of its elasticity will cause the oil leakage from pistons to the compression chamber where it will burn causing exhaust smoke. In the same time, burn gasses will leak to the engine block and burn the oil inside the block and engine sump.

There are two ways to obtain a more accurate diagnose of piston rings condition. The first is simple and does not require any apparatus. With the engine running at its operating temperature, engine breather hose has to be disconnected from air filter and amount of outgoing fumes have to be observed. Experienced mechanics will conclude how bad or good piston rings are on the base of fumes quantity. In fact, excessive evaporation shall indicate worn piston rings.

Another method is blowing compressed air into the cylinder on expansion stroke. Measuring the pressure drop will show the leakage trough piston rings. These are



Simple diagnostic gauge with compressor connection.

the two most reliable systems for diagnosing the condition of piston rings.

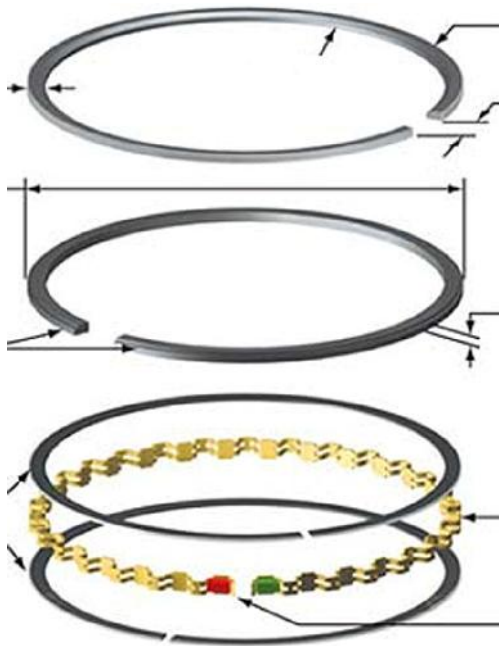
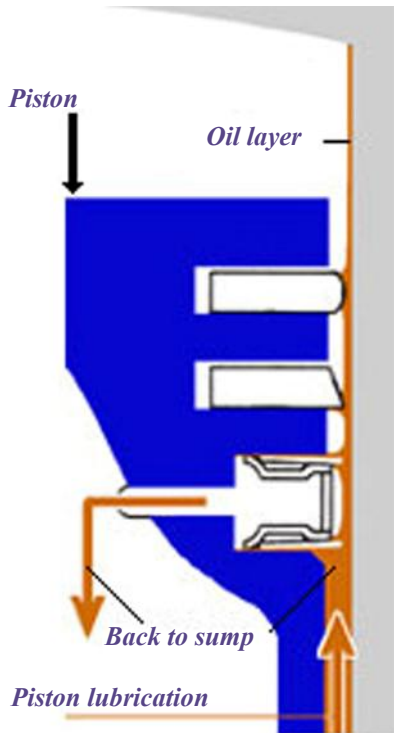

In the first sketch we see a partial view of piston and piston rings. The rings are named by their functions. That first is called compression ring. The main task of the first ring is to prevent pressure leakage during the compression and expansion strokes. We can see that surfaces of the second ring is slightly conical and it is called sweeping ring. Its function is to sweep the oil from the engine cylinder walls. The third ring is known as the oil ring. The function of this ring is to lubricate the engine cylinder. Through the porous central ring, engine oil lubricates the cylinder walls. Sharp edges will keep oil in its central part. Thus, sharp edges of oil ring are also used to sweep excessive oil deposit from cylinder wall. The second ring will sweep the rest and very thin film of oil will remain for lubricating the piston and the first piston ring.

In order to stick firmly to the engine cylinder, piston rings must be very flexible. As we can see on the left sketch, the rings have larger diameter than piston and cylinder bore. During installation, the rings are squeezed to the cylinder diameter and hold its tension in an effort to return to its original diameter. Due to the wear, the rings will lose its tension and will not stick well to the engine cylinder. Certainly in such a situation comes to compression leakage in the lower part of the engine, as well as oil leakage to the compression chamber where it will burn

with air-fuel mixture.

Worn piston rings are not the



only reason for gasses and oil leakage between pistons and cylinders. Worn piston rings grooves will also significantly affect leakage. Even if we change the rings on the worn piston (top photo) desired effect will be not achieved. No matter what new rings have good elasticity, compression and oil will find its way around the rings, or between the grooves and rings.

The greatest grooves wear occurs

on the first ring. In fact, this ring is directly exposed to a sudden pressure in the expansion stroke. Such power thrust on the first ring will result with groove widening. At the bottom left photo we see reinforced slot of the first ring. Reinforcement is performed by inserting a steel ring in the piston. Such a piston modification is most commonly encountered in turbo-diesel engines.

As we can conclude from the previous text, worn rings will cause the oil leakage in the upper part of the cylinder, where it will burn. The consequence: increased oil consumption, bluish smoke from the exhaust and smell of burned oil. However, the same problem does not have to be caused by worn piston rings.

As explained in engine lubrication chapter, oil lubricates the camshaft, valve lifters and the valves, which also cools. In order to prevent the oil leakage down the valves to expansion chamber, on the valves guides seals are installed. Seals have a function to sweep the oil from valves during operation, and to prevent the oil trickle down when engine is turned off. Over the years, exposed to high temperatures, seals get solid. It is not uncommon for seals in such state to get cracked. In this state, valve seals lose their elasticity and described function. The consequence: oil leak in the upper part of engine cylinder, where it will burn with air-fuel mixture. In other words, the same symptoms as with the

worn piston rings. Hence, it is advisable to make test with engine breather. In fact, if we notice excessive evaporation from engine breather we can conclude that piston rings are worn out. Thus, the increased oil consumption and smoke from the exhaust are present. However, if the vent has no significant evaporation, increased oil consumption and smoke can be attributed to worn-out valve seals.

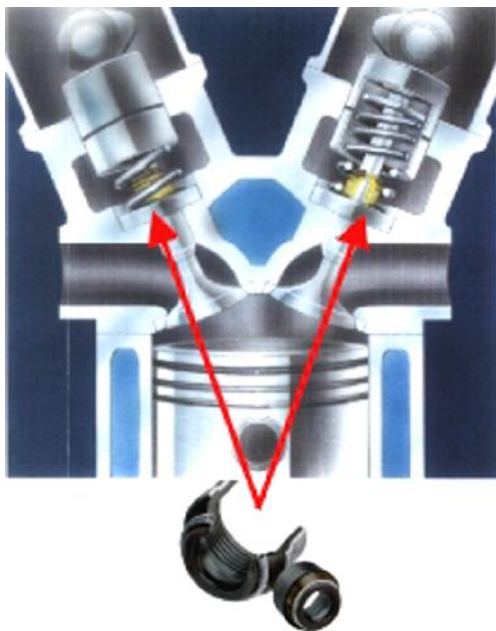

Valve seals positions



Valve seals

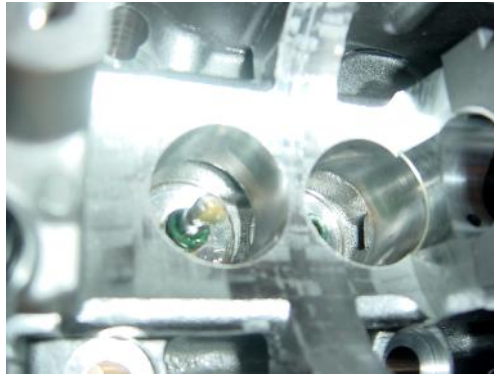

New valve seals installed

Making a proper diagnose regarding excessive oil consumption, will greatly help in making decision of engine repairing viability.

Cylinder head gasket

Often we find ourselves in a situation that we are not sure when diagnosing burned cylinder head gasket. In fact, it is easy to diagnose such a fault, when gasket is fully burned between the cylinder and the water passage. In such a case, the engine compression enters in cooling system with so much power that squeezes water out of it, even in attempt to start the engine.

However, the situation in case of slightly burned gasket is different. Usually we notice the loss of coolant which is not caused by failure of the hoses, radiator or water pump. Moreover, fluid loss may be noticeable only during long rides on the open road, while in city driving it is not noticeable.

In situation of slightly burned gasket, great and constant pressure will be required to break into the cooling system.

While driving in the city a vehicle is moving with a relatively low engine revs, on the open road revs will be much higher and constant. In these driving conditions, the pressure (compression) from the cylinder will easily pass to the cooling system channels through the porous part of the burned seals.

On the lower photo we see such a cylinder head gasket, which is only partially burned. Part of gasket inside the red ellipse is relatively well-sealed, but still a small percentage of compression will pass

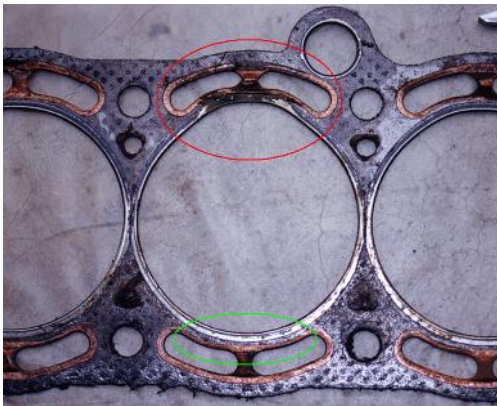

to the coolant channel. Of course, the damage on the burned section may be even lesser, in which case the compression will leak only at higher and constant speed. Inside the green ellipses, clean gasket surface indicates perfect sealing without flaws.

On a larger photo seal is completely burned on several places. The complete failure of compression between the cylinders will cause a loss of power in both cylinders and fussy engine at idle. Burned gasket between the cylinder and the coolant channels will cause displacement of fluid from the system, even when we try to start the engine. However, within both red ellipses we see a larger gasket surface, which obviously a long time does not perform its sealing function. This leads us to conclusion that service was not able to detect gasket failure in the beginning, but diagnose was made when gasket was

properly burned, when it was more than obvious what happened.

In order to diagnose the burned gasket on time based on leading indications, it is necessary to make some tests. Of course there are devices for such testing, but they are rarely seen at work shops, particularly small

ones.

If we suspect the failure of engine head gasket, means that cold cooling system must create pressure, lower or higher. Certainly it will be difficult to diagnose if it is a very small gasket leakage. Experienced technicians will recognize the increased pressure in the system, by testing the cooling system hoses flatulence (hardness), before than engine warms up. However, one has to be experienced enough to distinguish the hardness from anticipated pressure in the system due to the liquid expansion when heated, and the hardness of hoses due to excessive pressure in the system, caused by burned gasket.

If we do not feel experienced enough to perform the test described, or the gasket leak is so small to create so much pressure in the system when the engine is idling or when driving through the city, we will take the next test. In this case, we will perform test while the engine is completely cold. Namely, in case of engine head gaskets failure, pressure will be created in the cooling system after about twenty seconds. First step is removing the cap from radiator or expansion vessel. Close the hole with open hand and with finger vent pipe (if any). After about twenty seconds (engine running), we move finger or hand from the system. If there is pressure in the system due to the gasket leakage, we shall feel it liberated from system.

Even this test is not completely

reliable if there is a very small gasket leak. So, even if we did not succeeded to diagnose the gasket leakage with this test because we felt no pressure in the system, but still suspecting the gasket leak, we'll move on to the next test.

Suppose that vent pipe is on radiator or on the expansion vessel. We shall extend this vent with hose and immerse the hose in the pot with water. Removing the cap again we shall repeat previous action. Now we have ensured the pressure free flow in the vent. Closing the hose submerged in a pot with finger, we shall repeat the previous process running cold engine for twenty seconds. Releasing the blocked hose by finger, should not be any bubbles coming out from hose except the air which was in hose itself. If a greater amount of bubbles is noticed, it is a cylinder head gasket leakage.

In case that we have not went on disposal we will have to make rubber or corky plug for the radiator or expansion vessel, insert the plastic hose through it and make described test.

By this simple test we achieved proper diagnose. Cold coolant does not expand in the system, and does not create pressure. If pressure exists, it has to come from somewhere in the system. The only possibility of creating pressure in the cooling system with cold fluid is the cylinder head gasket leakage.

It often happens, when we already made correct and certain

diagnose that we find ourselves surprised when we do not see the traces of damages on cylinder head gasket. In such a case it is necessary to examine the head and look for cracks in compression space. This phenomenon is more common in diesel engines, in injector area and between the valves. Such cracks are hardly visible and often not wider than a hair. However, such a fracture is usually deep and extends to the channel with engine coolant. Compression leakage through the fracture will cause the problems previously described.

Examining the head gasket and finding not suspicious area, we can conclude that engine head is cracked. If we have opportunity, the engine head can be tested under the pressure for possible cracks. If not, we can find the cracks ourselves by very simple and old way. After the head is cleaned, surface has to be covered with chalk or powder. Cracked area will absorb the chalk or powder and cracks will be clearly seen. Cracks can be repaired by welding and machining afterwards.



The lower photo shows one part of the cylinder head covered with powder, where cracks are clearly visible.

In the next photo we see machined and aligned cylinder head after welding process. For such repair, complete cylinder head has to be taken apart. Most often, this



situation is used for valves and seals replacement in which case valve seats have to be machined too.

Poor braking effect and inefficiency of ABS and Electronic Stability Control

Sometimes we find a seemingly inexplicable situation regarding the insufficient braking effect. Checking the brake system, we mostly find everything in order, brake system working properly and brake pads replaced. This phenomenon will manifest in long braking distance, regardless of the force we put on the brake pedal.

Where is the problem? When servicing the vehicle, the common practice is replacing braking pads and not paying attention or ignoring deviations on brake discs or drums surfaces. In fact, even if

discs are checked, people are mostly concerned about discs thickness than uneven surfaces where the differences between grooves and hills can vary up to three millimetres.

In the photo below we see a callipers flat surface laid on the brake disc surface. In addition to considerable disc wear, it is easy to observe gibbosity of its surface. In



comparison with the same procedure on the new disk (next photo), it is not difficult to note the drastic difference in the surfaces of the brake discs.

In the same way how the callipers surface lies on the brake disc surface, the brake pads will lie too. It is easy to conclude how the brake pads will lie only on the hills of



the worn disc. By simple calculation we will come to the conclusion that only thirty percent of the brake pad performs the braking function. If we have a similar situation on all four wheels, only 30% of braking effect can be expected instead of 100%.

It is wrong interpretation how the brake pad surface will adjust to disc surface after some time. Namely, disc surface is very smooth and will not grind of the brake pad material in a way to adjust it to disc surface. On the contrary, the brake pads will slide on disc surface and the friction will heat up disc and brake pads. The result: no surfaces adjustment, but burned and carbonised brake pads. In other words, instead of

disc and pads surfaces adaptation, brake pads will burn due to friction on heat and will get carbonized.

The lower photo shows an ideal flat disc surface, on which brake pads are lying with full surfaces. Naturally, with such an ideal braking areas we can expect the absolute braking efficiency.

Knowing how the **ABS** works, it

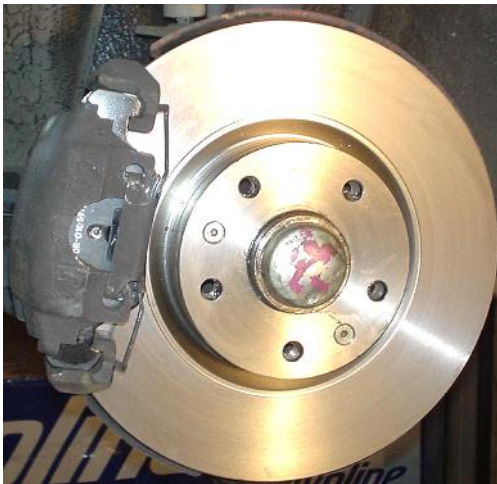

is not difficult to link described case with inefficient **ABS** effect. With worn discs, **ABS**, in principle, can not perform its function. As we know, when pressing the brake pedal wheels tend to lock and this is the moment when the **ABS** starts to function. Since in this case we have a braking effect of only thirty percent, the vehicle has barely ability to stop. In other words, the **ABS** will start functioning when vehicle stops. Long stopping distances, without any tendency of brakes locking, due to poor braking efficiency, **ABS** evaluates as completely harmless situation, and therefore will not respond. Beside disabling **ABS**, brakes in such

condition will considerably lengthen the braking distance. We also know that electronic stability control uses **ABS** system to control vehicle stability. Resume: bad braking effect - poor **ABS** performance. Poor **ABS** efficiency - aggravated electronic stability control.

If we now go back to my remarks about the shortcomings of diagnostic devices, this is a typical example of failure which device will not register. Thus, in attempt to find the cause of inefficient braking system with diagnostic device, there will be not any trouble codes readings. A vehicle with such a problem will even pass the **MOT** (technical inspection). In fact, when checking brakes on rollers, braking distance is not monitored. Instruments connected on rollers will only inspect braking equalization of front and rear wheels. When brakes finally block the wheel, vehicle will be simply ejected from the testing rollers.



FUELS AND LUBRICANTS

Motor vehicle fuel

When we are mentioning fuel and lubricants which power and allow the engine running, then we are talking about very complex subject about which, at least, one or two thick books have to be studied.

Considering how much prior knowledge someone should have to be trained to maintain and repair today's vehicles, it is not surprising that no one wants to read and learn from the fundamental-matter of electronics or chemistry. Fully mastering the originate of fuels for gasoline or diesel engines, as well as any chemical formula associated with them, one would certainly be led in another direction of professional occupations. The same applies to the electronics, as well as other science related to motoring. Therefore, highly trained professionals to maintain a motor vehicles shall be deemed a person which has a fundamental knowledge of all fields related to the motor vehicles science. That does not mean partial knowledge of a particular matter, but enough knowledge in all fields of science related to automobiles such as: fundamentals of material and processing, vehicle electricity, electronics, chemistry, physics, mathematics ..., covered in automotive industry.

Thus, this chapter will refer to fuel octane only as it is, among ot-

hers, the most important factor for proper engine running and its performances.

Octane fuel has nothing to do with the fuel power, but has been associated with resistance to fuel self-ignition during compression. This phenomenon is known as a detonation in the engine cylinder.

Based on fuel octane value, engine compression ratio is determined. In other words, knowing fuel octane value, we know how much it can be compressed before self-ignition occurs.

From fifties until today, the engine compression ratio changed with fuel octane value increment. The older generation will remember the regular gasoline 91, which was poured into the vehicles with the compression ratio 8-8,5:1. Since then, on the market is present gasoline **Super 95** and **Super 98**. With an increase in fuel octane rating, the engine increased compression ratio from 8:1 to 9,5:1, and even almost up to 12:1 at the present time. Taking into account the relationship between engine compression ratio and fuel octane value, it is understandable that vehicle manufacturer's instructions should be obeyed concerning recommended octane value. It is wrong interpretation that fuel with higher octane value will improve engine performances. On the contrary, instead of increased power, we will get loss of power. Very logical; under-compressed

mixture with higher fuel octane value will not produce expected effect as it would if lower, adequate, fuel octane value is used. If we are using a lower octane fuel than is predicted, it will lead to detonation or mixture self-ignition, and if knock sensor is not installed on the engine, result of explosions will be heard as clicking sound when accelerating, and the power loss will be noticeable. Namely, inflammation of the mixture occurs before than it is scheduled for this engine. Therefore, instead of having the down thrust on the piston at the moment when it passes the upper dead point, the piston will be suppressed down before it reaches top dead center. In other words, instead of using the full force of expansion (in the piston downward path), part of the power will be spent to stop the piston before top dead center, and only the remaining part of power in expansion stroke will be used for pushing the piston in desired direction.

Sometimes we hear that someone achieved better engine performances by using fuel with higher octane value. It can be sometimes true. The reason is usually poor fuel quality which is sometimes encountered, and does not match declared fuel octane value. Using fuel with higher octane value, we simply compensate deficiencies for the fuel that we should use.

In enthusiast circles, we can often hear stories about increasing engine compression ratio in order

to increase engine power. Knowing the relation between compression ratio and fuel octane value, it may be simply concluded that such an arrangement can only cause unwanted effects.

Actually, this story pulls back from late sixties and early seventies, when such a modifications were performed. If we go few sentences back, we see how compression ratio changes in comparison with fuel octane value. Therefore, if we had a Fiat engine with a compression ratio **8,1:1** and used regular petrol, we could modify the engine by reducing the expansion space. This is usually done by inserting modified pistons. Such pistons with upgraded top surface will reduce the compression space, and higher compression ratio is obtained, let's say **9,5:1**. After such modifications, we can use fuel with higher octane value and certainly achieve more power. On modern cars such modification is not possible, or it could be done, but there is no adequate fuel on petrol stations for such modified engines.

If we have in mind attempt to modify engine by increasing compression ratio, we should know following: Primarily we have to know which fuel we are going to use and its octane value. Based on the octane rating we will find out the maximum compression which fuel can withstand before self-ignition. After that we can proceed with increasing compression ratio. Compression is not calculated approximately or by measuring. It

is calculated by formula which is very simple and is set as follows: cylinder volume is added to the volume of compression chamber, a sum of these two volumes is divided by the volume of compression chamber.

Let's talk about a four-cylinder engine of 2000cc, or in the jargon, 2.0 litre engine. Volume of a cylinder with a piston at the bottom dead centre is 500cc. Suppose that the volume of compression chamber in the cylinder head is 50cc, making a total of 550cc (Centimetres-cubic). Dividing the volume of 550cc with a volume of 50cc, we get a compression ratio of 11:1. The volume measurement can be done in several ways; the simplest is to use the calibrated glass. Finally if we know how to calculate compression ratio and fuel characteristics, we can entertain ourselves by modifying engine compression ratio.

$$\frac{500 + 50}{50} = 11$$

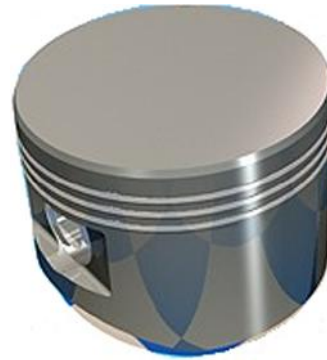
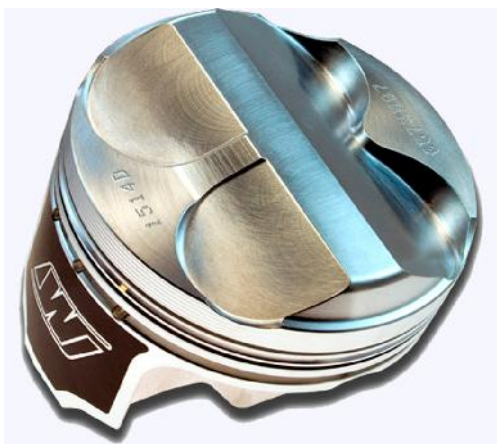

Standard piston



Modified piston

Diesel engines will not bother us with self-ignition nor fuel octane value. But we will encounter cetane value or cetane number of diesel fuel. What is the cetane number higher, duration of air-fuel ignition is shorter, allowing more time in the process of combustion.

Engine Oil

Engine oils are primarily designed for lubrication of moving engine parts. However, in addition to lubrication, oils have other properties. Additives are added to oils to

prevent corrosion, clean the engine of smut and heat release.

Under lubrication we understand creation a thin layer of oil between the sliding and rotating surfaces. The layer of oil will not allow direct contact between two surfaces and thereby prevent material overheating and rapid wear.

The concept of oil supply is solved on the way that maximum oil pressure is delivered between the

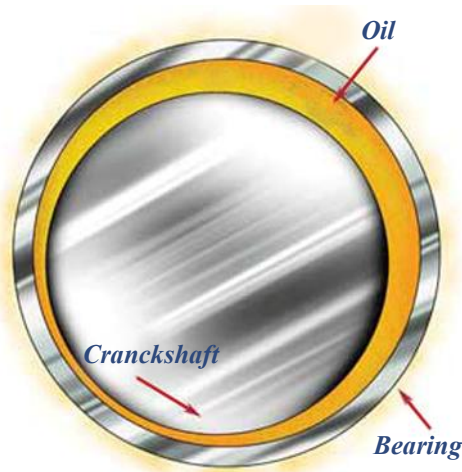

surfaces where the maximum load is present.

Engine oils are divided into mineral and synthetic oils. Mineral oils are obtained as a by-product in the distillation of crude oil.

Synthetic oils are obtained through artificial process, or synthesis of chemical elements.

The third variant of motor oil is known as semi-synthetic oil. This oil is a mixture of synthetic and small amounts of mineral oil.

Unlike mineral oil, whose properties are improved by considerable amount of additives, in

synthetic oil desired properties can be obtained during the creation of oil molecular structure. This will be mostly related to oil viscosity, which is achieved in mineral oil by additives, while in synthetic oils viscosity is created from the very beginning and subsequently increased by small amount of additives.

Viscosity is oil ability to keep the same density at the engine temperature oscillation. Namely, at the low temperature oil has a tendency of thickening, and diluting at high temperatures. In order to prevent poor or no lubrication at very low or high temperatures, engine oil must withstand such conditions.

Until late sixties, engine oils were sold with winter or summer gradations. These days oil change was required twice a year, regardless of mileage. But at the same time multigrade oils hit the market. These oils were resistant to low and high temperatures, where they got that name multigrade.

On the engine oil packaging gradation is indicated. Gradation is the international oil mark determined by **SAE-American Society of Automotive Engineers**. How to read or interpret the gradations? Suppose that we use the middle grades oil marked with **W 20-40**. The letter **W** stands for **Winter**, figure **20** for viscosity in cold conditions and figure **40** for working conditions at higher temperatures. The smaller is the first number oil is more resistant to low temperatures and vice versa. The higher the second number is the oil is more

resistant to higher temperatures. Certainly we'll be buying the oil to keep with vehicle manufacturer's recommendation. However, if we want to specify the oil grade ourselves, we will certainly take into account whether the vehicle is used somewhere in the coastal area or in the mountain area. If it is a coastal area, we will not search for oil with the first number smaller but higher second number. If it is a mountain area we will look for oil with lower first number. Someone will say it is easier to buy oil with the lowest first and highest second number. Yes, it is true, only those oils often have a price five times greater than the oil we really need. Such expensive oils will meet the needs of extremely aggressive driving. Therefore, it is necessary to know which oil meets engine requirements regarding conditions of vehicle exploitation.

As in the case of winter and summer oil grades, by the end of seventies we could still find on the market oil to flush the engine before pouring new oil. This oil was enriched with detergents in order to dissolve the smut and other substances deposited inside the engine. However, this procedure is not in practice any more. The current oils are added with detergents to dissolve substances which would otherwise be deposited inside the engine. Just because of mentioned deposits, it is not advisable to rely on manufacturer's instructions about oil changing intervals. The interval between oil changes is re-

duced in proportion to the vehicle mileage. Engines with a good deal of mileage have weakened piston rings, and thus the leakage of burned gasses into the engine block. Oil will use detergents to dissolve substances and thus saturate the oil. Due to the saturation, the oil loses substantially all its properties. In these properties enter corrosion protection, annulment of acids value etc.

We can find in the market oils, which are intended for use in worn engines and prolong their life. If common sense is used and knowing how engine works, it shall be easy to conclude that there is no such magic oil which can save or repair worn piston rings, bearings etc. What is it all about? In such oils additives are based on zinc which should replace missing material on worn surfaces. This partly may result in positive outcomes, but in engines which are mostly still in good condition. The same result is achieved by higher quality oil. Great disadvantage of such oil is catalyst clogging possibility due to deposition of zinc in its honeycomb.

Finally, as often interpreted, dark colour of engine oil does not indicate poor oil quality, but vice versa. Quality oil will dissolve layers of dirt in the engine and therefore become darker.





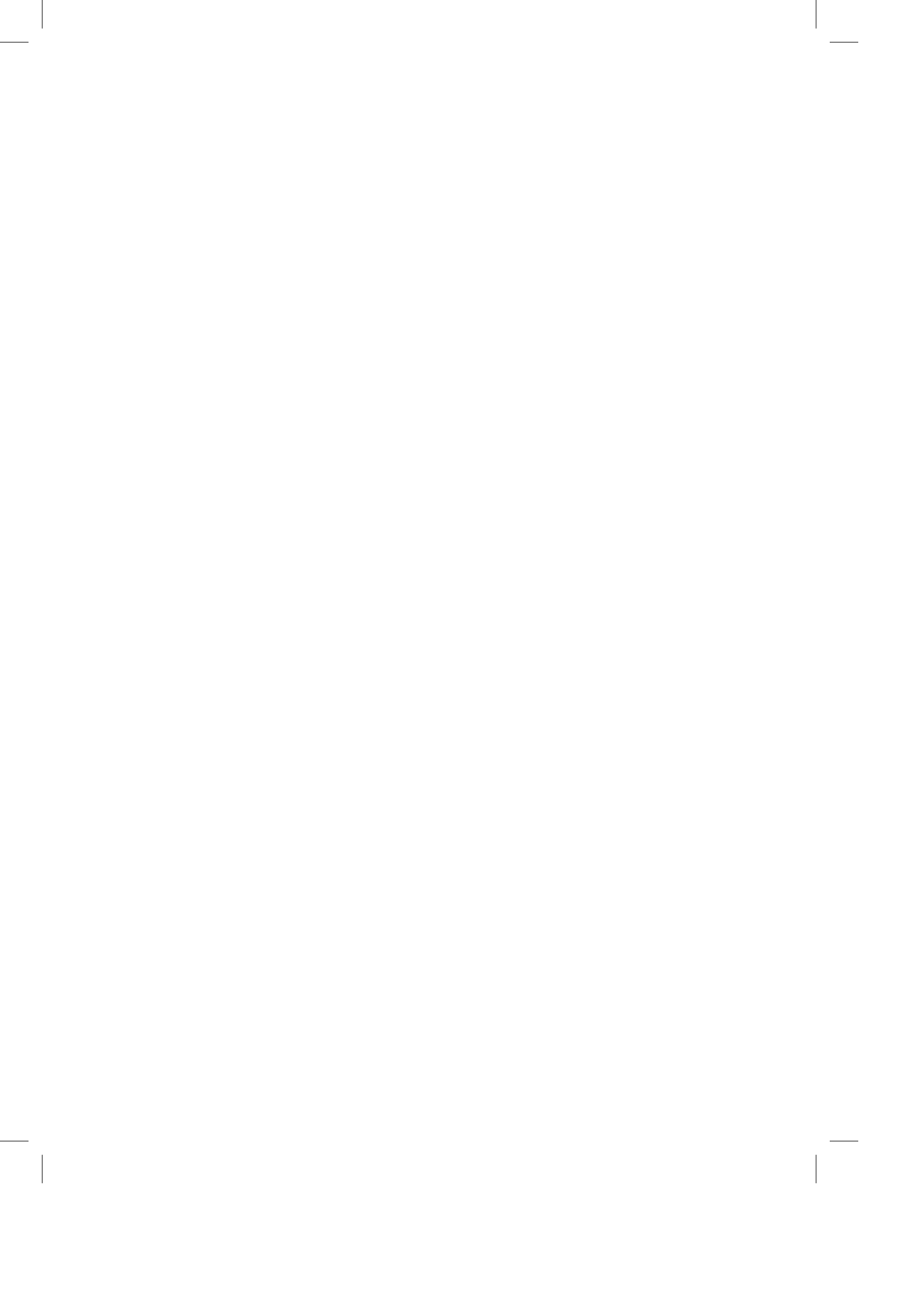

ISBN 978-953-95888-2-1



9 789539 588821 >