

# 9 easy to build projects under \$9

'By golly, Mildred. I like those little quick-n-easy projects in Modern Electronics. Think I'll just breadboard these up tonight. See how they work.' He loves them, and you will too. They're inexpensive, use readily available parts and are explained so you can understand them. Try your hand at one or all of our nine projects for a midsummer night's fun.

by Jeffrey A. Sandler  
Contributing Editor

## 1 Lantern extender

Here's a circuit that will give you almost three times the normal life of a lantern battery, and still provide all the light you'll need. The amount of light a bulb emits is dependent on the power it consumes. More voltage applied to the bulb causes more current to flow, increasing the power, and increasing the light emitted. This circuit doubles the voltage while limiting the current. The effective power remains the same, but battery life is extended due to the decreased current drain.

This reduction in current is achieved by using a technique called chopping, which is nothing more than turning the light on and off very rapidly. The period the lamp is on compared to the period between turn-ons is called the duty factor. A

50% duty factor means the lamp is on half the time, and off half the time. If twice the current flows for half the time, the average current flow is equal to the current that would normally flow.

Connecting a six-volt bulb to a 12-volt battery would normally result in the bulb immediately burning out. This is because doubling the voltage would double the current, which means the power would increase four times. But, if the duty factor were set to 50%, you'd have double the voltage and double the current, but only half the time. The average voltage and current would what you'd have with a six volt battery. So, connecting a six-volt bulb across the chopped 12-volt supply will give you the same light

as connecting it across a six-volt battery, but with half the current drain.

The circuit is built around a 4011 CMOS quad NAND gate. Two of the gates form the chopping oscillator, and a third is used to interface the chopper with any NPN power transistor with relatively high gain. If the bulb you're using requires relatively high current, you may need to add a fourth gate, as shown in dashed line. If you don't use the gate, be sure to tie its input leads to pin 14 of the IC. This will prevent self-oscillation in the unused gate.

Because CMOS uses little current, it can be powered directly from the 12-volt lantern battery. Parts layout is not critical.

The duty factor, and therefore the effective voltage and current applied to the bulb, depends on the setting of the control. Make sure the control is set at mid-range when first applying power. If the bulb is too bright, adjust the control to get normal brilliance. If the duty factor is set too high, the bulb will burn out in minutes, or even seconds.

You can, if you need a lot of light for a short period, set the control to give you a more intense than normal light. The bulb life will be shortened, but they're inexpensive enough to be considered a throwaway item.

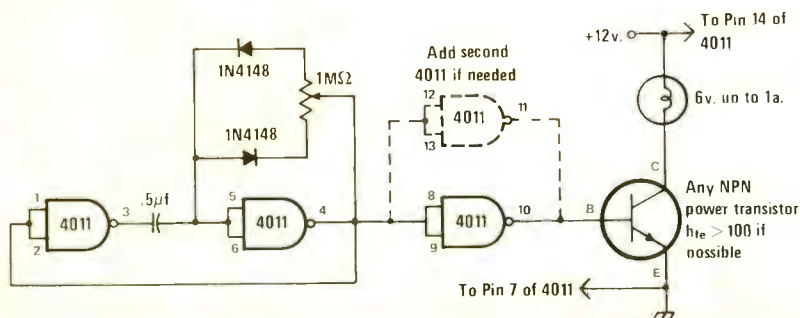

## 2 Free-running counter

This do-nothing circuit is sure to be the topic of conversation at your next party. It just sits there and counts at some predetermined rate with the count displayed on seven-segment LEDs.

This do-nothing uses half a 4011 CMOS quad NAND gate to generate an endless series of pulses. The rate at which the pulses occur is controlled by the setting of a variable resistor, and the value of the associated capacitor.

The pulses generated by the 4011 are used to trigger a 4026 counter. You can add as many 4026s as you wish, connecting pin 1 of the next IC to pin 5 of the preceding 4026. The seven outputs of each 4026 are used to drive the seven-segment LED display. You'll need one display for every 4026 you use. When all of the displays show the number 9, the next count will reset them to zero and the count will begin again.

You can further enhance the conversational value of your do-nothing by adding a reset/run function. It uses the other half of the 4011 as a flip-flop controlled by touchplate switches. The output of the flip-flop is connected to pin 15 of each of the 4026 ICs. If you don't add the reset, tie all four unused 4011 input leads to pin 14. This will prevent self-oscillation.

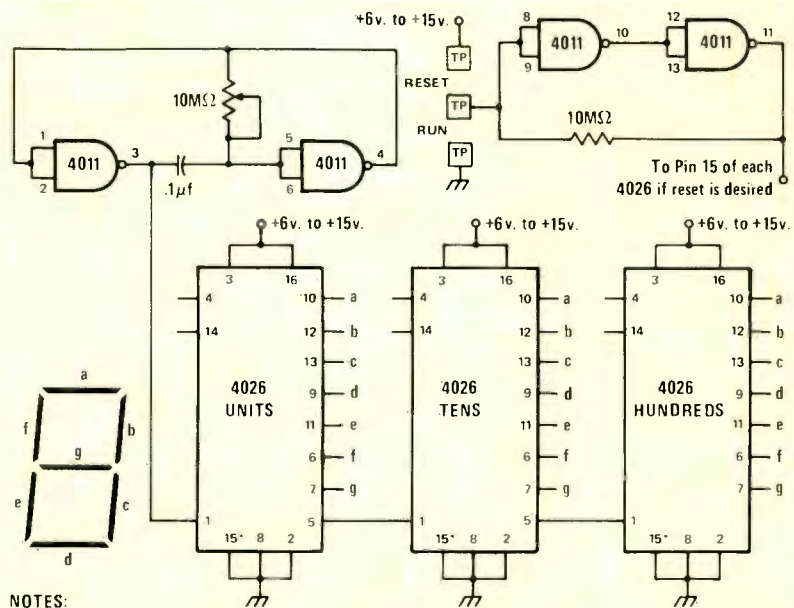

### NOTES:

+6v. to +15v. to Pin 14 of 4011 return to Pin 7 of 4011

No dropping resistors needed for most .3 to .8 inch LED displays.

The touchplate is made of three strips of metal, the center being about a half-inch wide, separated from each other by about 1/16th inch. When you bridge the gap between the center and the grounded strip, you set the flip-flop to its *run* state, and the counter counts. But, bridging the other gap will set the

flip-flop to its *reset and hold* state, which resets and holds the count at zero.

Although the circuit uses several ICs, the layout isn't critical. If you're using perf board, be careful not to short any of the IC pins together. You can power the unit from any six to 15-volt source.

## 3 Air meter

Here's an interesting do-nothing project that's sure to be a good conversation piece at your outdoor get-togethers. Built around an FET-input op-amp, the circuit measures the conductivity of air. You can use it to record changes in conductivity throughout the day as humidity and barometric pressure changes, or you use it for demonstrations by changing the position of the electrodes.

FET-input op-amps have extremely high input impedances—some approaching  $10^{12}$  ohms. This very high input impedance makes it possible to measure air resistance, which is in the millions of ohms per inch. By connecting two metal plates to the input of the op-amp, a minute, but measurable, current

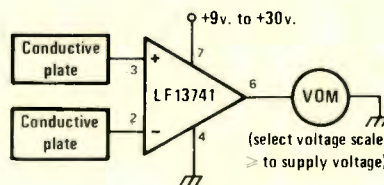

will flow between them. This current will be reflected in the output voltage of the op-amp. All you have to do is hang a voltmeter across the output and you've got your air meter.

Because the impedances of air and the op-amp are so high, the metal plates can't be mounted on

any material. Instead, they're hung in the air by the wires that connect them to the op-amp, which is itself hanging in air. The meter and battery leads can be used to suspend the op-amp and plates from a tree branch, clothes line, or other convenient support.

The LF13741 op-amp works best. But you can substitute a CA3140, or if you limit the supply voltage to no more than 15 volts, a CA3130 if you're unable to get a 13741.

One note of caution—Because the impedances are so high, make sure not to handle the op-amp with your bare fingers. The salts in your perspiration can form electrolytes on the package that will form leakage paths that can interfere with, or short circuit the air meter.

## 4 Intruder alarm

Here's a totally passive intruder detector you can use wherever there's constant illumination. The secret to its operation is reflected light.

The detector consists of just three parts—a photocell, a long tube painted black on its inside, and a large sheet of black, non-reflective material such as construction paper. The photocell is mounted at one end of the tube looking down its length.

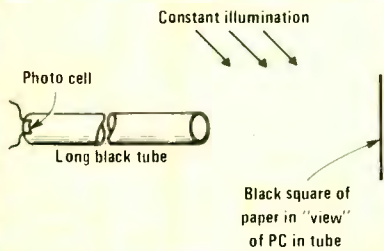

The photocell and black material are located so the photocell sees only black as it looks out the far end of the tube. The light source, which should be relatively strong, is positioned over or behind the tube. Then, when any object passes between the tube and the black material, some of the light will be reflected off it into the tube where the photocell will pick it up.

The presence of the reflected light will cause the internal resistance of the photocell to drop, and actuate an alarm. You can use the simple SCR alarm circuit shown here, or your own. The variable resistor is provided to let you adjust the sensitivity of the alarm. Set it so the alarm is almost, but not quite, tripped with the light source in its usual position and nothing between the tube and black material.

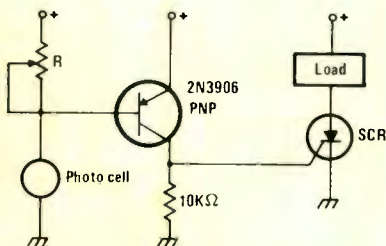

The photocell and transistor can be powered with a nine-volt transistor battery. The SCR/load circuit can be powered from any source providing the voltage and current required by your load, which can be a siren, bell, buzzer or other signal. Use an SCR that can handle the voltage and current involved.

## 5 Liquid level detector

This nifty alarm lets you know when a liquid rises above the level of two probes you fixed in place. You can build the circuit in two versions. One is actuated only when the liquid is at or above the level of the probes. The other is triggered by the liquid, but remains actuated even if the level drops below the probes. This latching action lets you know that the pre-set level has been reached or exceeded sometime in the past.

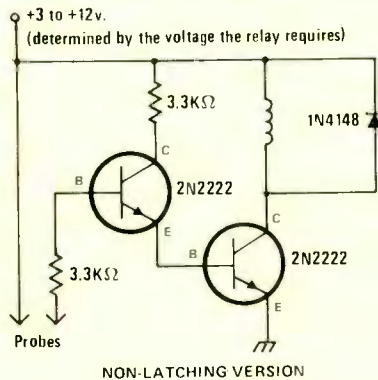

Both versions close relay contacts when actuated by the rising liquid. The contacts aren't shown in the diagrams because their connections

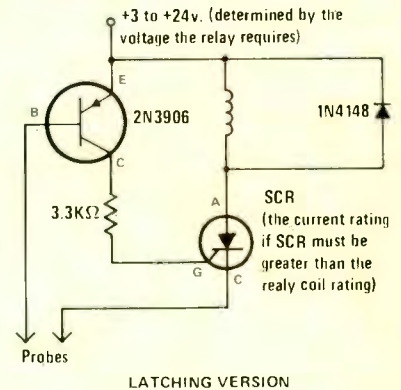

will depend on how you want to use the alarm. You can, for example, connect a buzzer or bell to give you an alarm signal that can be heard throughout your home or office. Or, you can use it to trigger a flashing lamp circuit. The possibilities are endless.

Parts layout is not critical. You can use a printed circuit board if you'd like, or hand wire on perf board. The circuit will operate from any voltage between three and 12 volts in its non-latching version, and three to 24 volts in the latching version. The choice of voltage will depend on the relay you use.

## 6 Tone relay

This tone-actuated relay circuit can be used to turn on, or off, a wide variety of devices. It's ideal for use with an intercom system where you occasionally want to leave a message or indicate you called. You can also use it for remotely unquenching a radio receiver.

The circuit is built around the LM567 tone decoder IC. The 567 requires about 100 millivolts of audio at its set frequency to function. The frequency the 567 responds to is set by a 10K variable resistor, and can be any frequency between 700 and 1500 Hz.

When a tone at the set frequency is present, the 567's output goes low. This change in output state is used to energize a relay through a 2N3906 PNP transistor. The relay contacts are not shown because their connection will depend on what you want the circuit to do.

Parts layout isn't critical. The alarm can be powered by a six or nine volt battery.

You can use a standard telephone

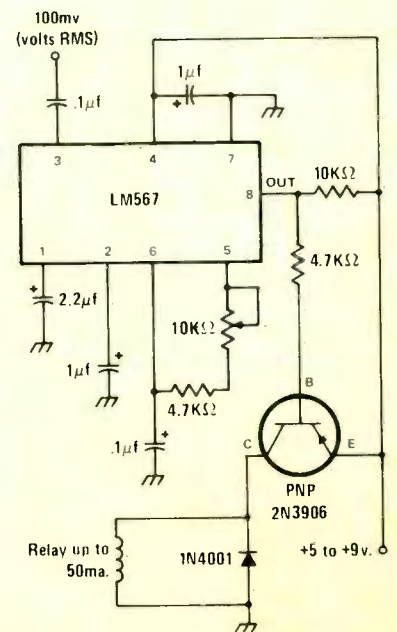

touchtone pad to generate the tone or you can build your own audio oscillator.

## 7 Telephone relay

Have you ever noticed the bells and horns used in garages, warehouses and other large or noisy operations to signal a phone call? Well, if you'd like a telephone alarm to let you know the phone is ringing, here's a circuit you'll like. Connected across the bell circuit of your phone, it closes a relay when the phone is ringing. You can use the relay contacts to actuate any bell, siren, buzzer or lamp you have handy.

The input circuit converts the pulsating signal used to ring the bell in the telephone into a dc voltage that charges a capacitor across the input of a 4011 NAND gate. When the voltage across the capacitor gets high enough, the gate changes state and trips a flip-flop. During the period the flip-flop is tripped, the relay contacts will be closed.

You can vary the period the contacts remain closed by changing the value of the resistor or capacitor connected to pin four of the 4011 IC. You can also adjust the sensitivity of the circuit with the variable resistor, R1. Lowering the resistance decreases the sensitivity of the circuit, but also makes it less susceptible to noise and dialing signals.

The circuit is straightforward, and parts layout isn't critical. You should exercise care in connecting the circuit to your phone, though. An accidental short won't endear you to the local phone company. They don't approve of your using circuits like this on their equipment.

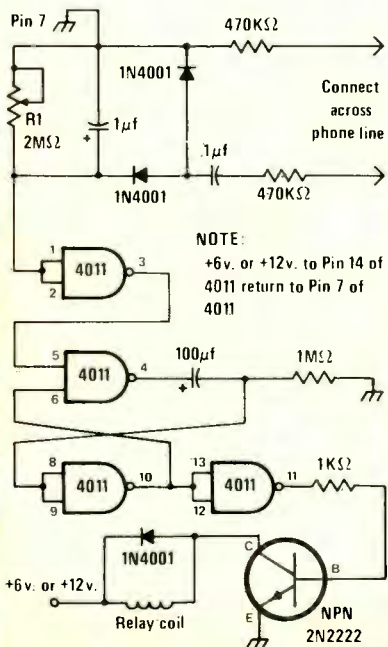

## 8 Four-channel mixer

If you're into audio or CB, you've probably wished you had a mixer circuit that would combine the sound from several sources into a single audio signal. Here's an inexpensive, easy-to-build mixer that should fill the bill. It uses a readily available LM381 op-amp and a handful of small parts, much of which you probably have in your junk box.

Because of the very high gain of the op-amp, it's important that the mixer circuit be well shielded from the 60 Hz fields present in your home. You can do this enclosing the circuit inside an aluminum box or cabinet, and using shielded cable for all the input leads. RCA phone connectors are the standard audio connector, and should be used for your input and output connections.

The circuit can be powered from any source of well-filtered nine to 24-volt dc. A nine volt transistor battery is ideal. If you need more

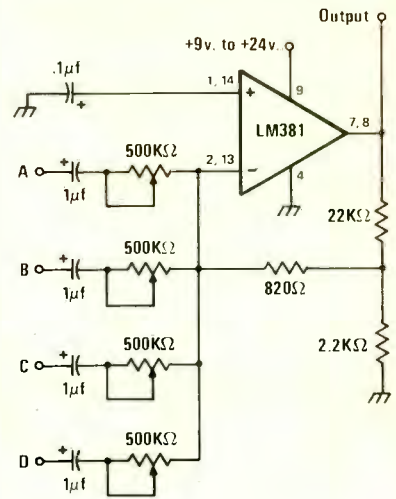

signal output, connect two nine-volt batteries in series. The batteries can be mounted inside the cabinet to reduce the possibility of hum pickup.

## 9 Auto burglar alarm

By David M. Mundy

Here's an interesting approach to auto burglar alarms that sounds the horn in your car when an intruder forces entry. It even has a special detector that'll sound the horn if someone runs into it, or tries to tow it away.

Although the alarm is triggered by the auto's ignition system, it has its own nine-volt battery to power the triac switch. When a door is opened, the dome light turns on. The voltage applied across the dome lamp actuates a reed switch which in turn triggers the triac. When the triac conducts, the auto's horn sounds.

A shaker switch is connected across the reed switch contacts. If the auto is shaken or tilted, as it would be if hit by another car or lifted for towing, the shaker switch will trigger the triac, and the horn will sound.

The alarm is turned on and off by means of a double pole, single throw key switch mounted on the auto body. However, there's a hidden reset switch you can use to kill the alarm if you loose your key.





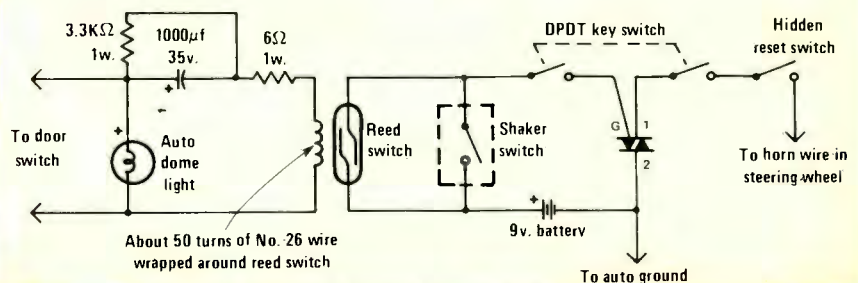





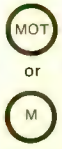



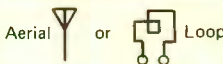













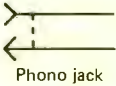

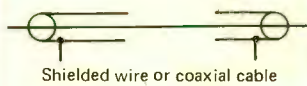



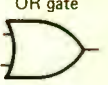

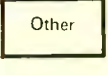





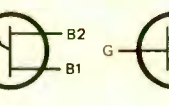
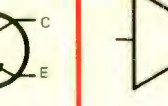
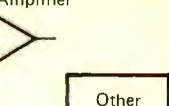
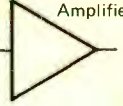

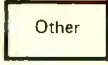







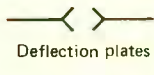
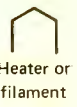
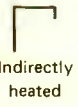
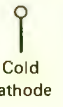
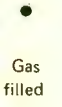
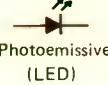



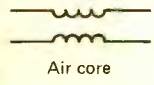
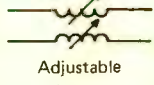
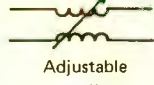
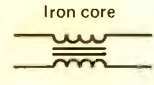
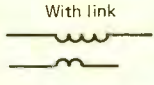





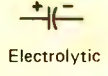

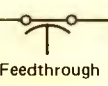

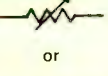
The parts layout is not critical. You can, if you want, split the circuit so that the reed switch wiring, shaker switch, and triac are widely separated. Being physically small, splitting the circuit will make it much more difficult for an intruder to locate—he'll be looking for a black box stuck under the dash or on the firewall.

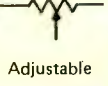
Using the horn is simple, but easy to defeat. The intruder need only cut a single wire and the horn will stop sounding. But, you can add a second horn or electric siren in a hard to get at location, using hidden wiring.



# Electronic symbols

## as used in Modern Electronics magazine

 <p>A = Ammeter V = Voltmeter mA = Milliammeter</p> <p>*Insert appropriate designations</p> <p><b>METERS</b></p>	 <p><b>MOTOR</b></p>	 <p>Single cell</p>  <p>Multicell</p> <p><b>BATTERIES</b></p>	 <p>Chassis</p>  <p>Earth</p> <p><b>GROUND</b></p>	 <p>Aerial or Loop</p> <p><b>ANTENNA</b></p>  <p><b>FUSE</b></p>  <p><b>MICROPHONE</b></p>	 <p><b>HEADSET</b></p>  <p><b>SPEAKER</b></p>	 <p><b>CRYSTAL</b></p>  <p><b>HAND KEY</b></p>	
 <p>Coaxial receptacle</p>  <p>Coax plug</p>  <p>Female</p>  <p>Male</p>  <p>230v.</p> <p><b>CONTACTS</b></p>  <p>Phone plug</p>  <p>Phone jack</p>  <p>Phono jack</p>  <p>Mic jack</p> <p><b>CONNECTORS</b></p>		 <p>Shielded wire or coaxial cable</p>  <p>General</p>  <p>Enclosure</p>  <p>Enclosure</p> <p><b>SHIELDING</b></p>		 <p>AND gate</p>  <p>OR gate</p>  <p>Inverter</p>  <p>Other</p> <p><b>LOGIC</b></p>			
 <p>Neon</p>  <p>Pilot</p> <p><b>LAMPS</b></p>		 <p>N-channel DUAL-GATE MOSFET</p>  <p>N-channel MOSFET</p>  <p>N-channel JUNCTION FET</p>  <p>N-channel UJT</p>  <p>PNP BIPOLAR</p>  <p>NPN BIPOLAR</p> <p><b>TRANSISTORS</b></p>				 <p>Amplifier</p>  <p>Operational amplifier</p>  <p>Other</p> <p><b>LINEAR INTEGRATED CIRCUITS</b></p>	
 <p>Ferrite bead ring</p>  <p>Air core</p>  <p>Tapped</p>  <p>Adjustable</p>  <p>Plug in</p>  <p>Iron core</p> <p><b>INDUCTORS</b></p>		 <p>Grid</p>  <p>Plate</p>  <p>Deflection plates</p>  <p>Heater or filament</p>  <p>Indirectly heated cathode</p>  <p>Cold cathode</p>  <p>Gas filled</p> <p><b>ELECTRON TUBE ELEMENTS</b></p>			 <p>Photoemissive (LED)</p>  <p>Zener</p>  <p>Diac (SCR)</p>  <p>Triac</p> <p><b>DIODES</b></p>		
 <p>Air core</p>  <p>Adjustable inductance</p>  <p>Adjustable coupling</p>  <p>Iron core</p>  <p>With link</p> <p><b>TRANSFORMERS</b></p>			 <p>Triode</p>  <p>Pentode</p>  <p>Voltage regulator</p> <p><b>COMPLETE TUBES</b></p>		 <p>SPST</p>  <p>DPST</p>  <p>SPDT</p> <p><b>RELAYS</b></p>		
 <p>Electrolytic</p>  <p>Fixed</p>  <p>Variable</p>  <p>Feedthrough</p>  <p>Ganged</p> <p><b>CAPACITORS</b></p>		 <p>Fixed</p>  <p>Adjustable</p>  <p>Tapped</p>  <p>Adjustable</p> <p><b>RESISTORS</b></p>		 <p>SPST</p>  <p>Rotary</p>  <p>SPDT</p>  <p>Push-Pull</p> <p><b>SWITCHES</b></p>		 <p>No connection</p>  <p>Terminal</p>  <p>Connection</p>  <p>Connection</p> <p><b>WIRING</b></p>	