

Construction project:

HIGH ISOLATION CURRENT ADAPTER

Making use of a new Hall effect sensor available from Fastron Technologies, this simple project enables you to take mains current measurements of up to 10 amps in complete safety, with readings accurate to 1%. Due to the high bandwidth of the sensor used in this project, you can also use your scope to examine and measure any waveform components from DC up to 25kHz — again in complete safety.

by **GRAHAM CATTLEY**

Examining mains current waveforms is usually quite a dangerous business. The usual way to do this is to insert a small value, high wattage resistor in series with the mains input, and then monitor the voltage drop across it with an oscilloscope. This requires the scope to be run off an isolating transformer, as the scope's ground will be effectively at mains potential. Needless to say, this situation is potentially lethal, as all exposed metalwork on the scope will be sitting at 240V...

You may be tempted to use a voltmeter instead of a scope, but if the current drawn by the device isn't sinusoidal (as in a switchmode power supply, for

example), the meter will often give you a false reading.

A common way around these problems is to use a current clamp ammeter. But although these are much safer to use, they tend to have a limited frequency range — which again results in false readings for non-sinusoidal currents. This, added to the fact that clamp meters usually only measure currents above 1A, makes measuring mains currents difficult, inaccurate and expensive.

A better way

Hall effect current sensors, on the other hand, eliminate most of these problems with their intrinsically high

galvanic isolation, high bandwidth, and low insertion loss. This project, based on the HY10-P Hall sensor offers a safe, accurate and cheap way out of all of the above problems, while incorporating the following features:

- Negligible insertion loss;
- No heat buildup in the sensing device;
- DC to 25kHz frequency response;
- A high slew rate (better than 30A/us);
- Negligible inductance, resulting in virtually no phase shift throughout the operating frequency range;
- An output of 400mV/A at an accuracy of +/-1%; and
- A minimum current measurement of around 10mA.

As you can see, these features add together to give a very useful piece of test equipment, and at quite a reasonable cost too.

About Hall effect

Before we get into describing the operation of this project, a brief explanation of the Hall effect might be in order.

Back in 1879, Edwin H. Hall, a little known American physicist at Johns Hopkins University discovered a phenomenon which later became known as the Hall Effect.

He began by considering a problem first posed by James Clerk-Maxwell, concerning the force on a conductor carrying a current in a magnetic field. Does the force act on the conductor, or the current carriers? Hall argued that if the current carriers were affected then there should be "a state of stress... the electricity passing towards one side of the wire".

In his original experiments, Hall found that if a strip of gold leaf, carrying an electric current longitudinally, was placed in a magnetic field, the points directly opposite each other on the edges



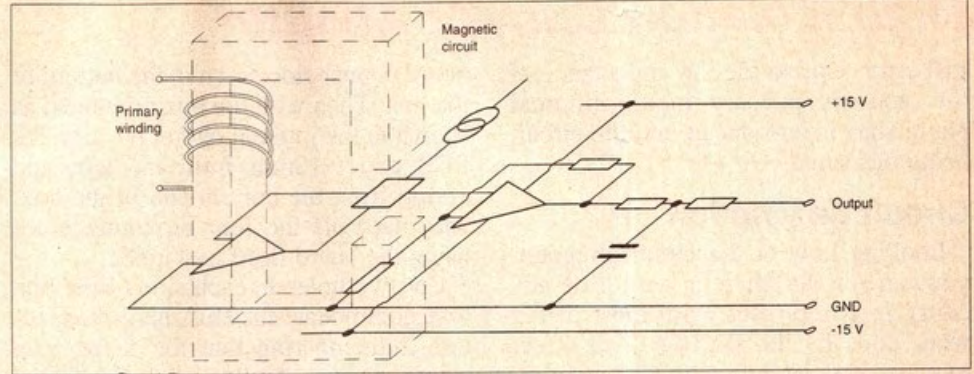
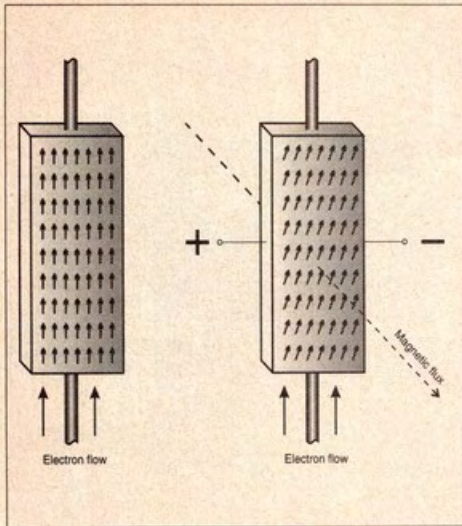

Fig.1 (left) shows how a magnetic field distorts the flow of electrons through a piece of silicon, causing a potential difference to be developed between each side of the wafer. Fig.2 (above) is a diagram showing the basic construction of the Hall current sensor, with the Hall element sitting in the magnetic field caused by current flowing through the primary winding.

of the strip acquired different electrical potentials which he was able to measure with a sensitive galvanometer. He later found that different metals caused different potentials and in some cases, even reversed polarities.

The ratio of this transverse electrical potential to the strength of the magnetic field became known as the 'Hall Coefficient' for the metal in question.

It was later found that *semiconductors* have higher Hall coefficients, and therefore produce higher voltages for given magnetic fields.

It is for this reason that most modern Hall effect devices consist of a small silicon wafer through which a reference current flows. If you look at Fig.1, you can see that on the left is a representation of a silicon wafer with a constant current flowing through it. On the right, however, is the same wafer when subjected to a magnetic field at right angles to the electron flow. Here, some of the electrons are pushed off-course by the field, and accumulate on the right hand

side of the wafer.

This results in a difference in potential between the two sides, which is the Hall voltage. This voltage is directly proportional to the strength of the magnetic field, and is defined as:

$$V = (R_h \cdot I \cdot B) / t$$

where V is the Hall voltage produced, R_h is the Hall coefficient for the material used, t is the thickness of the material, I is the reference current flowing, and B is the magnetic flux density.

In the Lem HY series of sensors (the type used in this project), the current to be measured is used to create a magnetic field within the device, causing the Hall element to generate a voltage of 1.25mV/mT. (A constant control current (I) is generated within the module, and is factory set to 5mA.) This Hall voltage is amplified within the module to give an output voltage of 400mV/A.

The sensor

The HY10-P Hall effect transducer (Fig.2) consists of a high current primary

winding (of only one or two turns), and a ceramic substrate on which the Hall sensor, amplifier IC, film resistors, and other SMD components are mounted. This is all encapsulated in a self extinguishing epoxy block, and gives an electrical isolation of 2.5kV.

While we have used the 10A version in this project, the HY series of sensors includes modules rated at up to 25A. Each module is laser trimmed to give 4V +/-40mV at its rated RMS current, and gives a measuring range of up to three times this value. (It is also rated to withstand surges of up to 50 times its rated current.) The HY range of sensors use an open-loop system, resulting in an accuracy of +/-1% whilst maintaining a low power consumption.

The main advantage of using Hall effect devices in current sensing is that they are able to measure current over a wide frequency range. The bandwidth of these devices is typically DC to 25kHz, enabling currents to be measured right through the audio spectrum with mini-

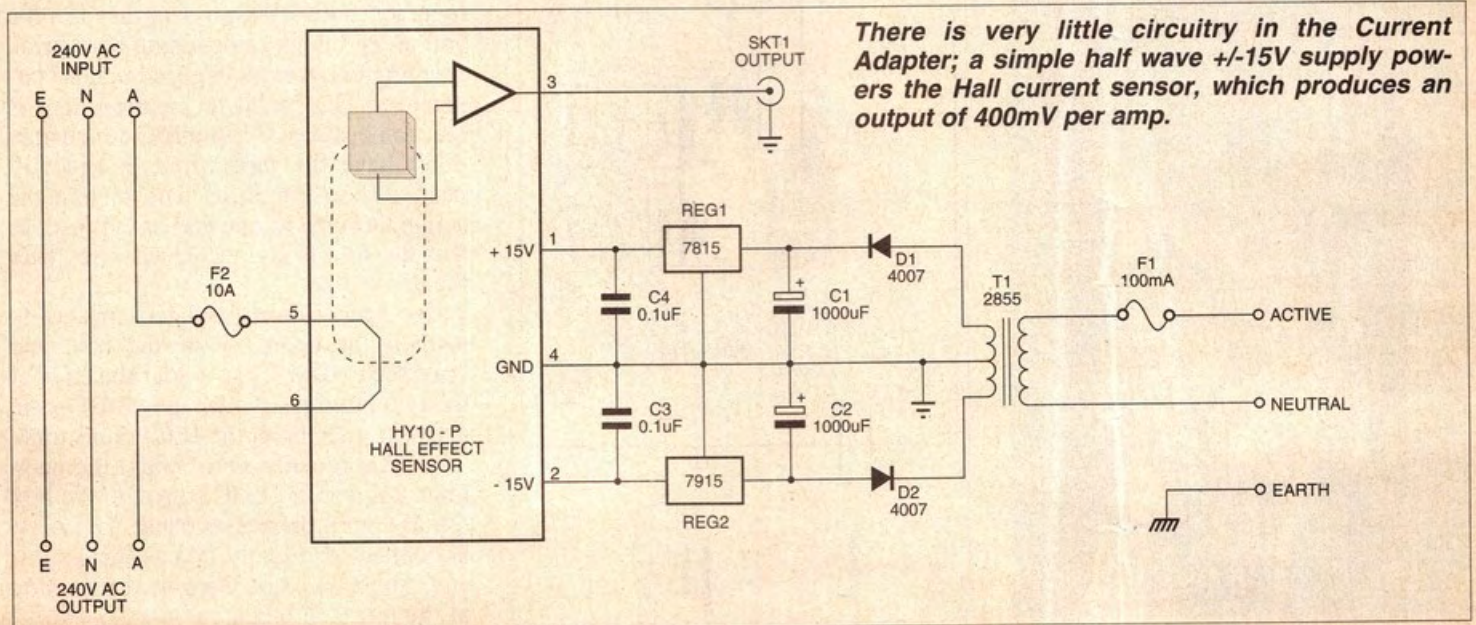

High Isolation Current Adapter

mal error. Due to the low inductance of the sensor's primary input, minimal phase shift is introduced into the circuit being measured.

Circuit description

Looking now at the circuit diagram, you can see that there is very little circuitry in this project, with most of the work done by the HY10-P Hall effect module. This module requires only a +/- 15 volts supply, and draws approximately 10mA. These supply requirements are provided here by a small centre-tapped 30V transformer, and simple half wave rectifiers using D1 and D2. The output from these diodes is filtered by the two 1000uF electrolytics, and each rail is then regulated by 15 volt regulator.

The output impedance of the sensor is quite low at 100 ohms, it's able to source up to 10mA. Thus it doesn't require buffering — the output is taken directly to the BNC socket mounted on the front panel.

Construction

Construction of the current adapter falls into two main areas: mounting the parts on the PCB, and mounting the power transformer along with the IEC power sockets and associated mains wiring.

Start by placing the unpopulated PC

board copper side down in the bottom of the box. Then with the box orientated as shown in the internal photo, position the PCB about 10mm from the left, and 15mm from the bottom end of the box, and mark off the four mounting holes using the board itself as a guide.

Cut two holes in each side of the box to accommodate the IEC mains connectors, remembering that the fused plug (input) goes on the left, while the socket (output) is mounted on the right.

Once you have finished this (surprisingly tedious) task, cut an 85 x 40mm piece of 1mm aluminium sheet, and mount the power transformer to it as shown in the photos. Use two short countersunk bolts to mount the transformer, and long countersunk bolts for both the earth connection and for securing the terminal block.

Position the transformer mounting plate 15mm from the top end of the box, and screw it into place with another two countersunk bolts and nuts. Drill two holes for the fuse holder and mains cable entry, and wire up the transformer primary with the fuse holder wired in the active line.

Use a piece of heatshrink sleeving over the fuse holder, and don't forget to use a P-clamp to secure the mains cable.

Moving onto the PC board, the nine

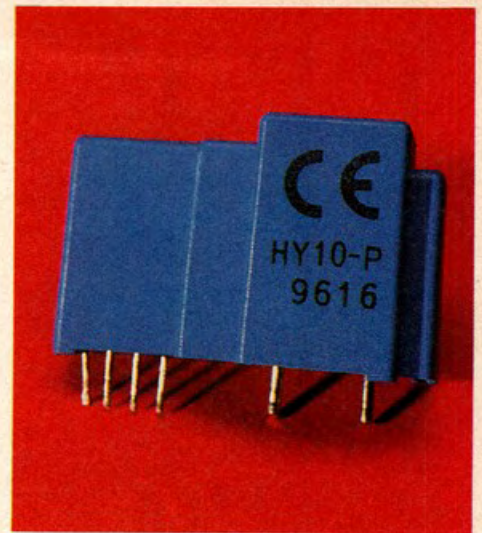

The HY10-P Hall effect current sensor. With a peak current rating of 500A, and a frequency response of DC to 25kHz, this sensor lends itself to many applications.

components on it can be installed in almost any order, but watch the orientation of the diodes, regulators and the electrolytics — check with the overlay diagram when installing these components.

Cut two 50mm lengths of brown or red mains-rated heavy duty cable, strip and tin the ends, and solder them to the two large pads that connect to the sensor primary. It is a good idea to use plenty of solder on these two pads, as they will need to carry up to 10 amps once the circuit is running.

Solder a short length of single core shielded cable to the output pads on the PCB, and connect the transformer's secondary to the board, ensuring that the centre tap is connected to the middle of the three pads.

The neutral and earth pins of the two IEC mains connectors can now be wired together with 100mm lengths of blue and green mains cable, using heatshrink sleeving to cover all exposed mains connections. One point to mention here is that some styles of fused IEC connectors don't have the fuse wired in and will need a short length of wire to join the active terminal to one end of the fuse, so that the fuse is connected in series with the active line.

Use four 10mm insulated spacers to support the board inside the box, and once secured, you can solder the ends of the two previously attached wires to the active terminals on the IEC connectors.

All that remains is to mount the neon indicator and the BNC socket in the box lid, and wire them into place. The neon is connected directly across the mains, and is best wired on the transformer side of the terminal block.

This photo shows how the PCB is mounted off-centre in the box, making room for the mains wiring from the IEC connectors. At right is the component overlay diagram.

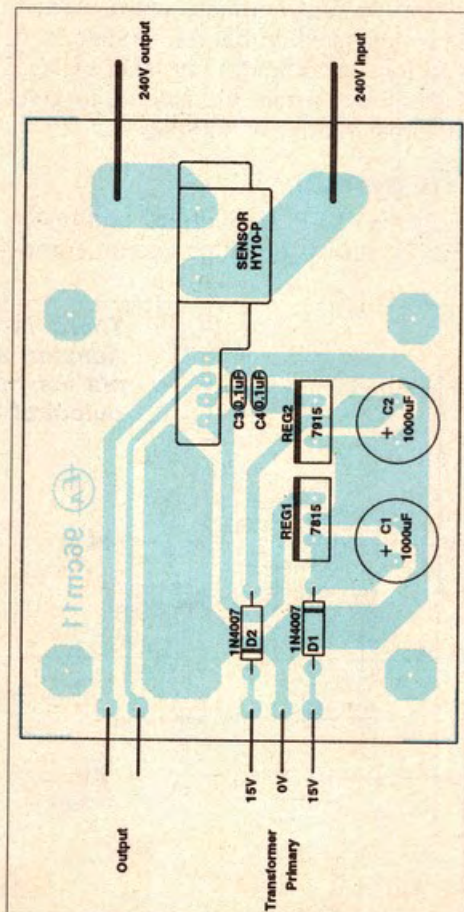
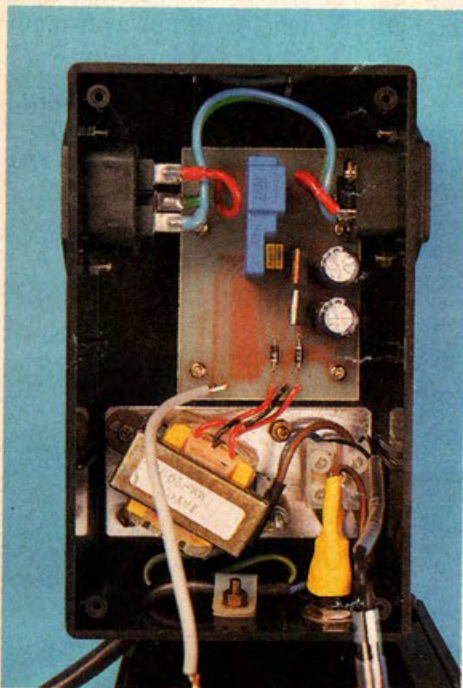

Using the adapter

Plug the current adapter into a mains socket, and the neon should glow, showing that the unit is operational. The unit will now produce an output voltage directly proportional to the current flowing through the two IEC connectors. Probably the best way to demonstrate the current adapter is to monitor the current flowing into a switch-mode power supply, as found in most computer systems.

Plug a computer into the output socket of the adapter, connect the input socket to the mains, and use an oscilloscope to monitor the output voltage. Fig.3 shows a plot taken from such an arrangement, and you can easily see the spikes of current drawn from the supply in these systems. This contrasts with the current waveform from a resistive load (a light bulb or heater for example), which results in a sinusoidal current waveform, reflecting the linear relationship between current and voltage.

One final note: if you want to measure higher currents, you can easily replace the HY10-P module with a higher current version, such as the HY25-P, which can handle up to 25A RMS. This will require high current wiring, and appropriately rated mains connectors to be used, however. You may also need to enlarge the holes in the PCB to accept the HY25-P sensor's larger primary pins.

If you wish to take advantage of the sensor's DC - 25kHz frequency response for audio applications (like measuring the current in a loudspeaker), you may want to replace the two IEC connectors with suitable connectors for your chosen application. ♦

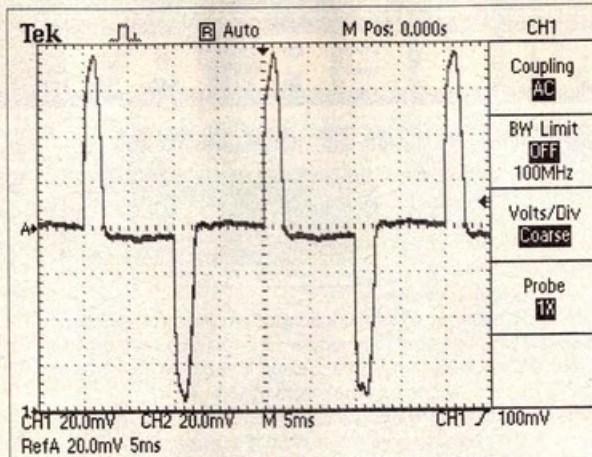

The output of the Current Adapter monitoring a computer's switchmode power supply. Note the high current peaks that are typical of these types of supplies.

PARTS LIST

Capacitors

C1,C2 1000uF 25VW electrolytic
C3,C4 0.1uF MKT

Semiconductors

D1,D2 1N4002 power diodes
REG1 7815 15V positive regulator
REG2 7915 15V negative regulator

Miscellaneous

HY10-P Hall effect sensor module; PCB, 55 x 76mm, coded 96ca11; Power transformer 15-0-15 volts, (type 2855); M205 safety fuse holder; 1 x 100mA and 1 x 10A M205 cartridge fuses; 240V neon indicator; Fused, 240VAC IEC panel mount mains plug; 240VAC panel mount mains socket; Panel mount BNC socket; Plastic box 150 x 90 x 50mm (type UB1); Two-way mains terminal block; Four 10mm insulated spacers; Mains cable with plug; P-type cable clamp; Heatshrink; Nuts, bolts, etc.

Note: the Lem HY10-P Hall effect sensor module used in this project is available from Fastron Technologies, of 14 Dingley Avenue (PO Box 1212), Dandenong 3175; phone (03) 9794 5566, or fax (03) 9794 6670. The quoted price for the device in unit quantities is \$36.60, plus \$3.00 packing and postage.

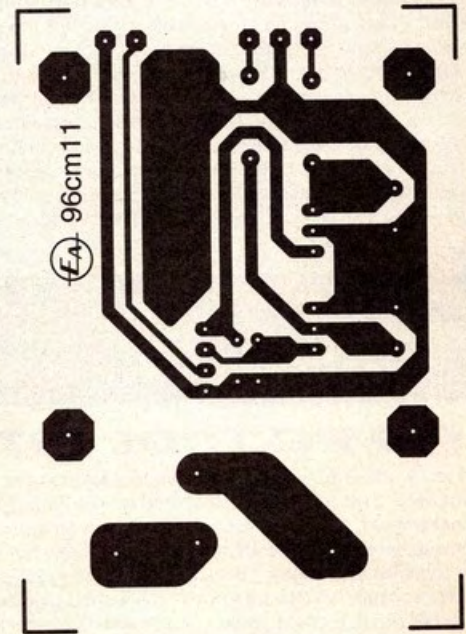

HIGH ISOLATION
CURRENT ADAPTER



POWER ⊕
OUTPUT ⊕
(400mV/A)

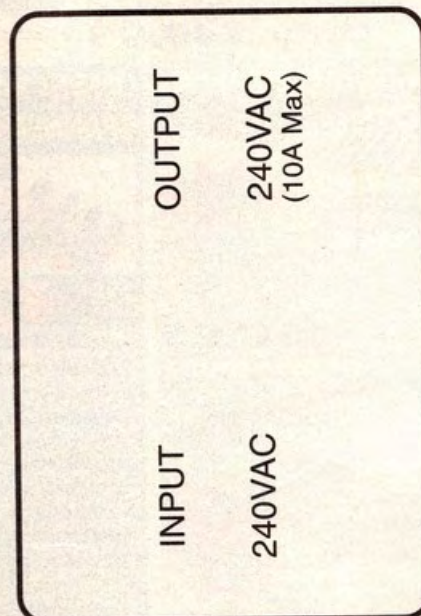

Full size artwork for both the PCB (above), and the front panel, on the left.