



A *Howard W. Sams*® PHOTOFAC T PUBLICATION

# TROUBLESHOOTING with the OSCILLOSCOPE



By **ROBERT G. MIDDLETON**

AN INDISPENSABLE "HOW-  
TO" GUIDE ON USING AN  
OSCILLOSCOPE IN SERVIC-  
ING ELECTRONIC CIRCUITS.

**\$2.50**

**Cat. No. TOS-1**

# **TROUBLESHOOTING with the OSCILLOSCOPE**

**By ROBERT G. MIDDLETON**

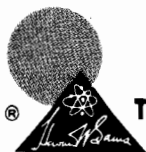

**HOWARD W. SAMS & CO., INC.**

**THE BOBBS-MERRILL COMPANY, INC.**

*Indianapolis • New York*

FIRST EDITION

FIRST PRINTING — FEBRUARY, 1962

SECOND PRINTING — JUNE, 1962

**TROUBLESHOOTING WITH THE  
OSCILLOSCOPE**

Copyright © 1962 by Howard W. Sams & Co., Inc., Indianapolis 6, Indiana. Printed in the United States of America.

Reproduction or use, without express permission, of editorial or pictorial content, in any manner, is prohibited. No patent liability is assumed with respect to the use of the information contained herein.

Library of Congress Catalog Card Number: 62-12658

## PREFACE

Troubleshooting modern electronic circuits literally demands the use of an oscilloscope, yet many service technicians experience difficulty in learning how to use this versatile instrument.

Of the numerous service technicians who have difficulty in employing an oscilloscope, many own or have used one, but really don't understand its functions well enough to set it up for proper waveform displays. On the other hand, technicians who fully understand the workings of a scope rate it among their most valuable instruments.

This book was planned and written with the full realization of the type of practical instructional help needed by service technicians. Its purpose is to help you obtain the maximum benefits from a scope, even if you have never used the instrument before.

Beginning with the first chapter, you'll learn the purpose and function of every oscilloscope operating control. Whether your unit is simple or elaborate, the mystery of how it operates is dispelled in this introductory chapter.

The next subject is the selection and application of probes, a very important consideration in obtaining proper waveform displays. Subsequent chapters are devoted to explaining how a scope is used in localizing TV troubles to specific receiver sections, and then to a particular stage. In several cases, you'll find it possible to use a scope to pinpoint the defective component itself.

Use of the scope is divided into two general categories—signal-tracing circuits supplied with external signals, and checking waveforms in signal-generating stages which operate independently of external signals. Since a scope can often give more information when particular types of external signals are utilized, material has been included to explain the advantages of using CW and modulated sine waves, video waves, FM sweep signals, and square waves.

While the major portion of this book concentrates on troubleshooting television circuits, chapters on servicing radio receivers and audio amplifiers have also been included to give you the thorough background needed to use the scope for checking practically any type of electronic circuit. To obtain the maximum value from the contents, I strongly suggest you actually work with your equipment as the various procedures are described. This "reinforced learning," gained at the workbench, will more than double the benefits you will derive from reading alone.

ROBERT G. MIDDLETON

January, 1962

# TABLE OF CONTENTS

## CHAPTER 1

How to Operate an Oscilloscope . . . . .	7
Intensity-Control Adjustment—Centering-Control Adjustment—Focus-Control Adjustment—Setting the Horizontal-Amplitude and -Function Controls—Application of a 60-Cycle AC Test Voltage—Pattern Size Versus Intensity-Control Setting—Gain Controls—Frequency Control—Retrace Blanking—Horizontal Nonlinearity—Calibration and Peak-to-Peak Voltage Measurements—Complex Waveforms—Step Attenuators—DC Versus Peak-to-Peak Volts—Sync Function—Lissajous Patterns—Display of Narrow Pulses—Display of Square Waves—Fluctuating Line Voltage	

## CHAPTER 2

Using Oscilloscope Probes . . . . .	42
Low-Capacitance Probe—Demodulator Probes—Resistive Isolating Probe—High-Voltage Capacitance-Divider Probe—Stray Fields—Wide-Band Versus Narrow-Band Response—Inconsistent Low-C Probe Response—Ground Lead of Scope Probe	

## CHAPTER 3

Signal Tracing in RF, IF, and Video Amplifiers . . . . .	59
Troubleshooting RF Amplifiers—Signal Tracing in the IF Section—Signal Tracing in the Video Amplifier	

## CHAPTER 4

Signal Tracing in the Sync Section . . . . .	77
The BU8 Circuit—Readjustment of Vertical-Centering Control—Sweep Frequency for Waveforms with Alternate Symmetry—Sync Separator with Phase-Inverter Stage—Circuitry Variations	

## CHAPTER 5

Troubleshooting the AFC and Horizontal-Oscillator Section . . . . .	87
Oscillator or AFC Trouble—Signal-Tracing the Horizontal-Oscillator Section—Synchroguide Ringing-Coil Check—Ringing-Coil and Multivibrator Configuration—Circuit Variations	

## CHAPTER 6

- Waveform Tests in the Horizontal-Sweep Section . . . . . 98  
Sweep-Circuit Troubleshooting—Low Drive—Narrow Picture  
—High-Voltage Power Supply—Boost-Voltage Filtering—Key-  
stoning

## CHAPTER 7

- Troubleshooting the Vertical-Sweep Section . . . . . 108  
Vertical Synchronization—Coupling Capacitor Checks—Feed-  
back Waveforms—Vertical-Output Transformer—Cathode Cir-  
cuit—Vertical-Blanking Network

## CHAPTER 8

- Signal-Tracing the Sound and Audio Section . . . . . 118  
Test Signal for the Intercarrier Section—Minimizing Circuit  
Loading—Limiter Characteristics

## CHAPTER 9

- Troubleshooting Power Supplies . . . . . 127  
Stacked B+ Configuration—Input Waveform to Filter—Inci-  
dental Bypassing Function—Current Waveforms—"Above-  
Ground" Test Methods

## CHAPTER 10

- Radio-Receiver Troubleshooting . . . . . 135  
Scope Requirements—Gain Measurements—Type of Test Sig-  
nal—Oscillator Defects—IF Stage Troubles—Audio Stage Tests  
—Hum Tracing

## CHAPTER 11

- Testing Audio Amplifiers . . . . . 145  
Linearity Checks—Phase Shift—Linear Time-Base Displays—  
Square-Wave Tests—Overshoot

- Index . . . . . 155

## CHAPTER 1

# How to Operate an Oscilloscope

Oscilloscopes are easy to operate, although they have a comparatively large number of controls. Even the simplest scopes (Fig. 1-1) have about a dozen knobs and switches. However, if the action of each control or switch is taken step-by-step, the instrument soon loses its mystery. All service scopes are AC-operated, and hence have a power cord which must be plugged into a 117-volt, 60-cycle outlet.

To turn the scope on, set the power switch to its "on" position. The power switch may be an individual control or it may be combined with an operating control—usually the intensity control. In this case, the control is turned from its "off" position to the right, just as a radio or TV receiver is turned on. When power is applied to the scope circuits, a pilot lamp lights, or in some cases, an edge-lighted graticule is illuminated (Fig. 1-2).

### INTENSITY-CONTROL ADJUSTMENT

After a brief warm-up period, a spot or line may appear on the screen. If not, then turn up the intensity control. Do not advance it, however, more than is necessary, because the screen of the cathode-ray tube can be burned, particularly if the electron beam is forming a small spot on the screen.

If a spot or line does not appear when the intensity control is turned up, either the horizontal- or vertical-centering control (positioning controls) may be at the extreme end of its range. This can throw the spot or line off-screen. Therefore, begin the operating procedure by adjusting each centering control to its mid-range.

### CENTERING-CONTROL ADJUSTMENT

The action of the centering controls is seen in Fig. 1-3. The spot moves up and down when the vertical-centering control is rotated back and forth. Similarly, the spot moves left and right



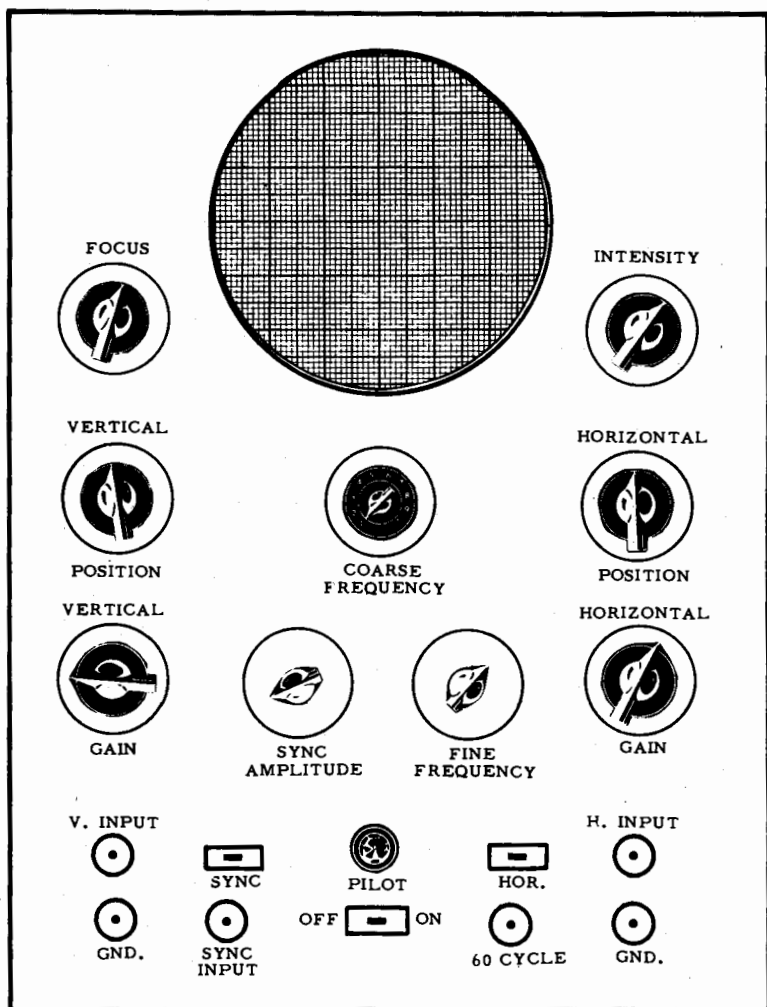
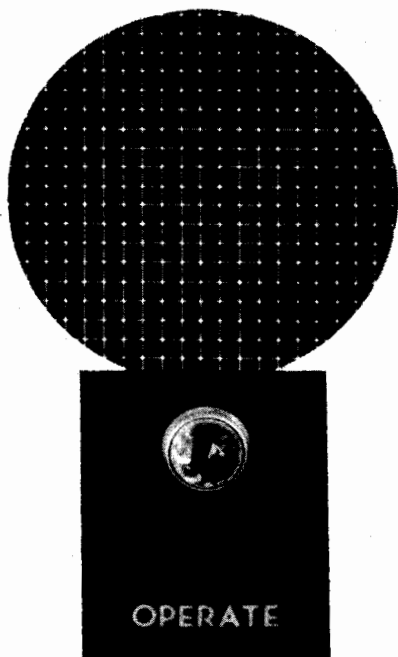

Fig. 1-1. Typical panel layout for a simple oscilloscope.

when the horizontal-centering control is rotated back and forth. In theory, any desired pattern could be traced out on the screen by turning the centering controls. This is a simple manual analogy to pattern development which takes place automatically in the scope when its electronic circuits are energized.

In practice, of course, patterns are not traced out in this manner. The centering controls are set to locate the beam suitably on the screen, and are not readjusted unless particular test conditions make this desirable. Different *types* of patterns may not appear centered on the screen, unless the centering controls are readjusted, for reasons that will be explained. Again,

**Fig. 1-2. Some scopes have illuminated graticules; most have simple pilot lights.**



certain features of waveform analysis may require specific adjustments of the centering controls.

### **FOCUS-CONTROL ADJUSTMENT**

Action of the oscilloscope focus control can be compared with that of a TV receiver. Fig. 1-4 shows how the appearance of a spot changes on the screen as the focus control is turned. The focus control is adjusted for the smallest spot possible. In most scopes, the intensity and focus controls interact. Therefore, the focus control may need to be readjusted if the intensity-control setting is changed.

The reason for this interaction is apparent from Fig. 1-5. The focus control varies the DC voltage applied to anode 1 of the cathode-ray tube, and the intensity control varies the voltage on the cathode. The electrostatic flux lines thus produced between the electrodes form a "lens" which focuses the electron beam. If the intensity voltage is changed, the focus voltage often must be changed also, in order to maintain correct lens formation.

Note the astigmatism control in Fig. 1-5. It varies the DC operating voltage of anode 2. In some scopes, this voltage is fixed. In others, a screwdriver adjustment is provided inside the case, or an external astigmatism control is provided, as in

Fig. 1-6. The astigmatism control provides uniformity to the focus control, so that the pattern is focused properly in all portions of the screen. The astigmatism control interacts, to some extent, with the focus and intensity controls.

A circular pattern is illustrated in Fig. 1-6. (How to display a circular pattern will be explained later.) However, a circular pattern is not necessary in order to adjust the astigmatism control. A simple spot can be used. If the spot has the same size when it is moved from the center of the screen to the four screen edges, in turn, the astigmatism control is adjusted properly.

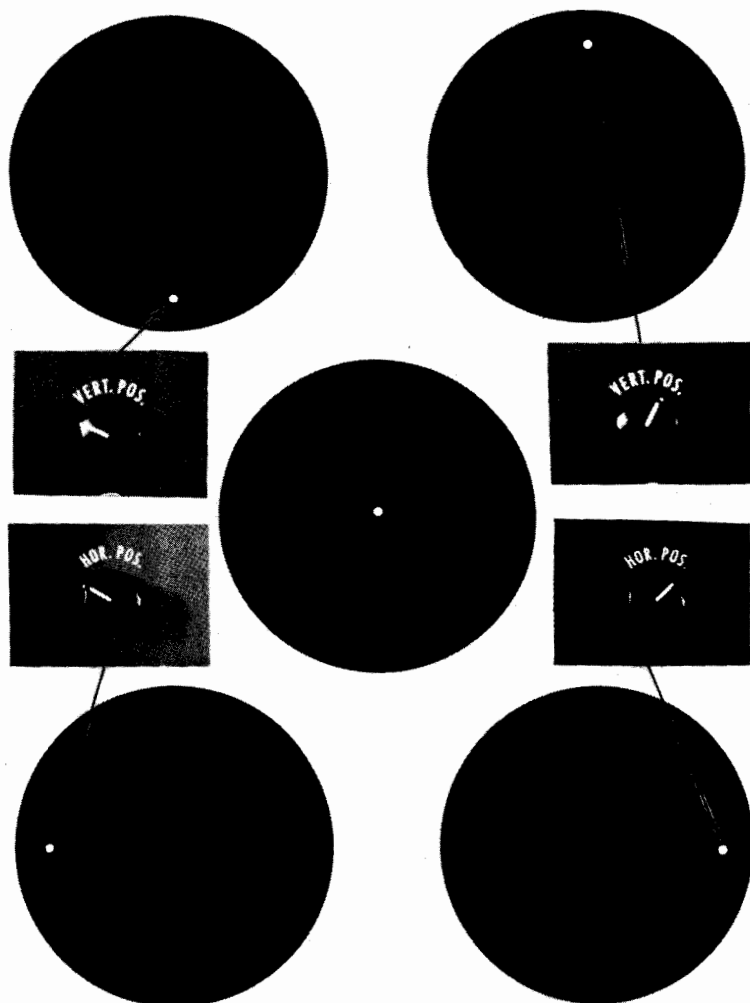

Fig. 1-3. Action of positioning (centering) controls.

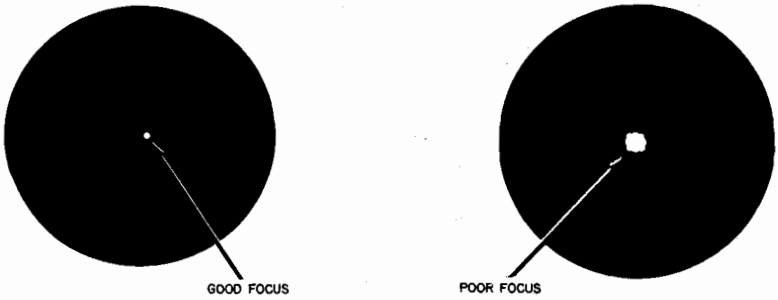

Fig. 1-4. Action of focus control.

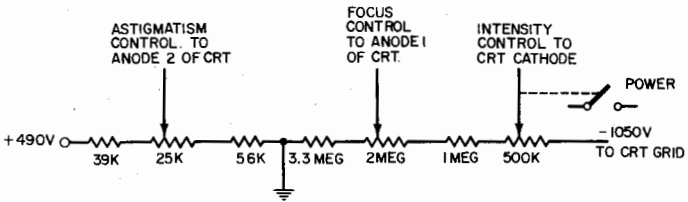

Fig. 1-5. Focus and intensity functions.

### SETTING THE HORIZONTAL-AMPLITUDE AND -FUNCTION CONTROLS

The horizontal-amplitude control is shown also in Fig. 1-6. It is sometimes called the horizontal-gain control. This control adjusts the width of the pattern. If the control is turned to zero, a spot is displayed on the screen. As the control is advanced, the spot spreads out horizontally into a trace, as shown in Fig. 1-7. If the trace does not appear, check the setting of

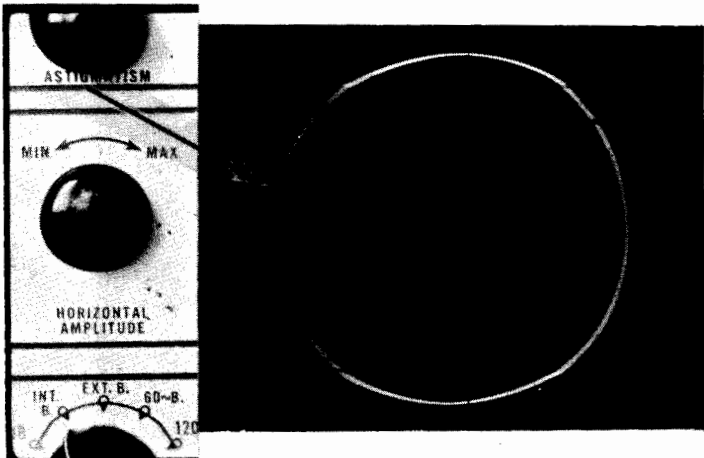

Fig. 1-6. Astigmatism control completes the edge focus.

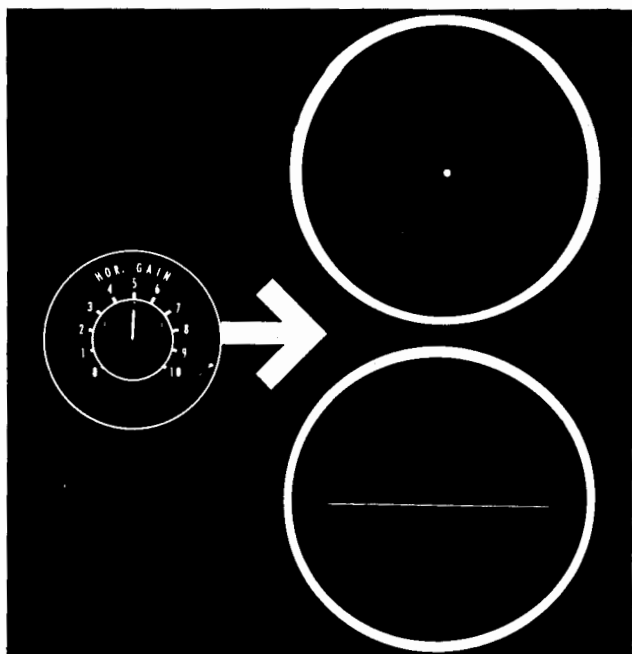

Fig. 1-7. Action of horizontal-gain control.

the horizontal-function control (Fig. 1-8). If this control is set to the "horizontal-input" position, as shown, little or no trace length will be obtained in this procedure. Set the control to + or - Sync, for ordinary displays of waveforms on sawtooth sweep.

The present purpose is served best by setting the horizontal-function control to the "plus sync" position. Why this is so,

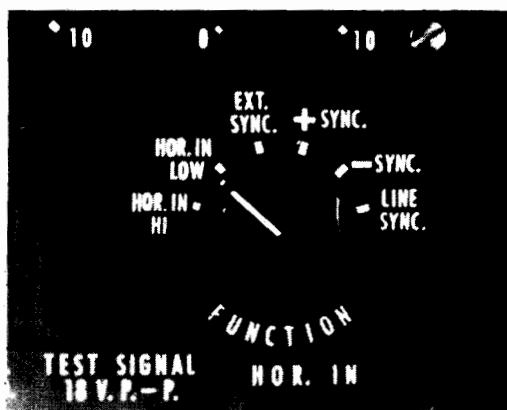

Fig. 1-8. Typical function control.

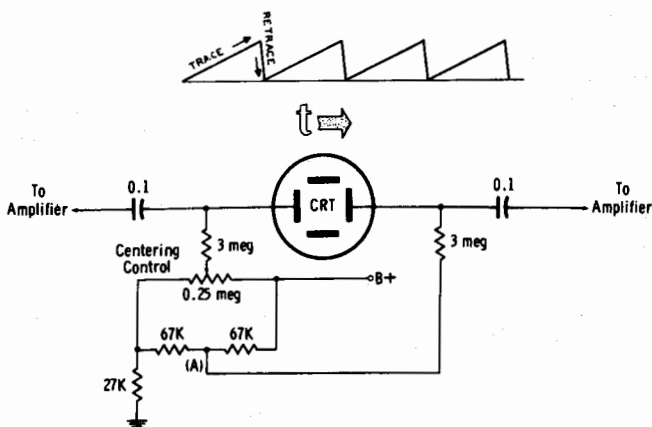

Fig. 1-9. A sawtooth voltage deflects the beam back and forth.

will appear in the following discussion. Briefly, a sawtooth-voltage signal is applied to the horizontal-deflection plates in the CRT when the function control is in this position, as in Fig. 1-9. In turn, the electron beam is deflected horizontally.

A sawtooth voltage is linear, so the spot moves uniformly in time from left to right across the screen. During the brief retrace interval, the spot quickly returns to the left side of the screen. Because of this linear or uniform motion of the spot, sawtooth deflection is called a linear time base. In other words, each inch of horizontal travel takes place in the same time interval, when sawtooth deflection is used. This permits the display of voltage waveforms as a function of time.

### APPLICATION OF A 60-CYCLE AC TEST VOLTAGE

All scopes have binding posts or a coaxial connector for applying a vertical-input signal to the scope. If a 60-cycle test voltage is applied to the vertical-input post, a sine-wave pattern can be displayed on the scope screen. A suitable test voltage can be obtained by connecting a pair of test leads from the

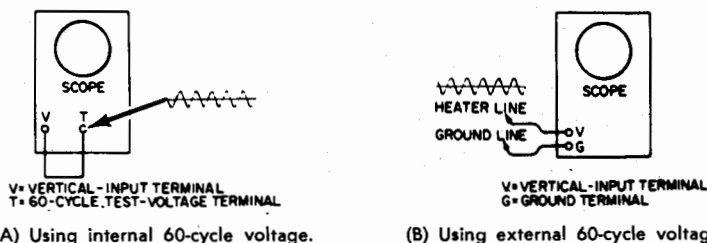

(A) Using internal 60-cycle voltage.

(B) Using external 60-cycle voltage.

Fig. 1-10. Connections for viewing a 60-cycle waveform on a scope screen.

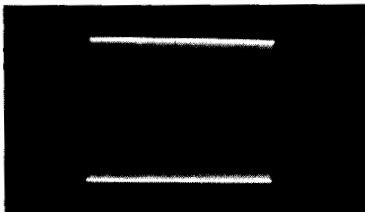

Fig. 1-11. Waveform appears as a blur on the screen when horizontal-sweep rate is too low.

vertical-input terminals to the heater line and to ground in a radio or TV receiver. Or, many scopes have a 60-cycle test-voltage terminal provided on the front panel, as in Fig. 1-10. A lead can be connected, in that case, from the vertical-input terminal to the test-voltage terminal.

A sine-wave pattern may or may not appear when the test voltage is applied. This depends upon proper setting of certain operating controls. For example, if the horizontal-deflection rate is incorrect, only a blur may be displayed as in Fig. 1-11. Practically all scopes have a coarse and a fine (vernier) saw-tooth frequency control. The coarse control is a rotary step

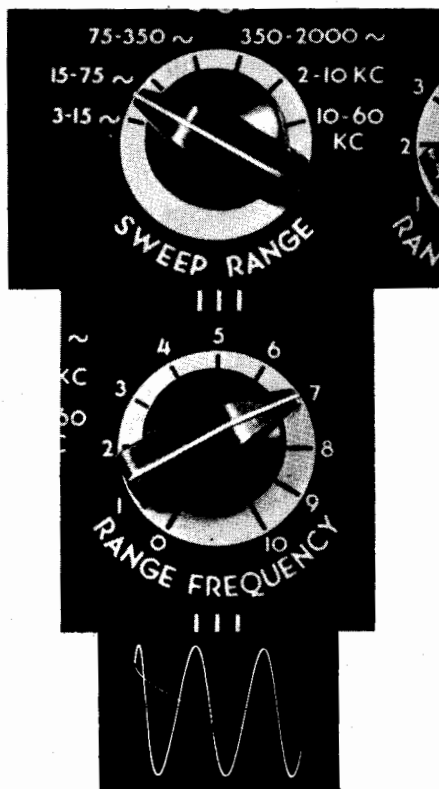

Fig. 1-12. Frequency controls.

switch; the vernier control is a potentiometer. These are also called the sweep-range control and the range-frequency control (Fig. 1-12).

Set the step control to a position which includes 60 cycles (in Fig. 1-12 this is the 15—75-cycle position). Adjustment of the continuous control "fills in" the step, and permits the saw-

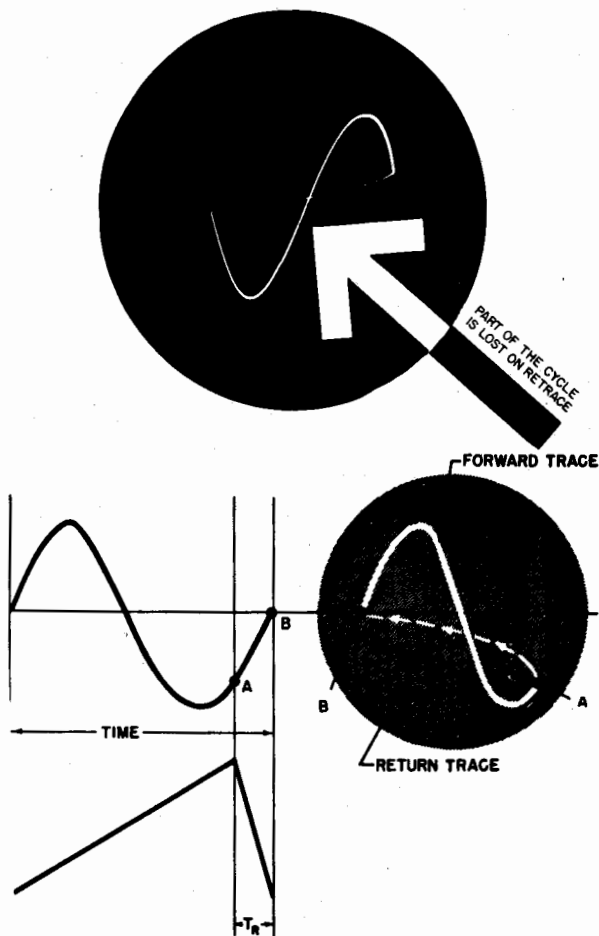

Fig. 1-13. Detail of a single-cycle display.

tooth oscillator to operate at 60 cycles. Rotate the control to see whether a single-cycle display appears on the screen. Possibly no other adjustments will be required, and a pattern such as detailed in Fig. 1-13 may appear. Note that the displayed cycle is not quite complete. A small portion is "lost" on retrace, because the sawtooth voltage does not drop to zero instantly during retrace time. The lost portion is often seen as a visible



retrace line in the pattern. The retrace line may be visible as in Fig. 1-13.

At this point in the procedure, the required adjustment of the vernier sawtooth control may be very critical. Perhaps the single-cycle display can be stopped only for an instant, and then it "breaks sync," with reappearance of a blurred pattern. On the other hand, the pattern may lock tightly, but appear broken into fragments. The first difficulty is due to the sync control being set *too low*. The second difficulty is caused by the sync control being set *too high* (Fig. 1-14). In either case, the pattern is locked properly by the sync control. The practical rule is to advance the sync control sufficiently to lock the pattern, but not so far that the operation of the sawtooth oscillator is disturbed.

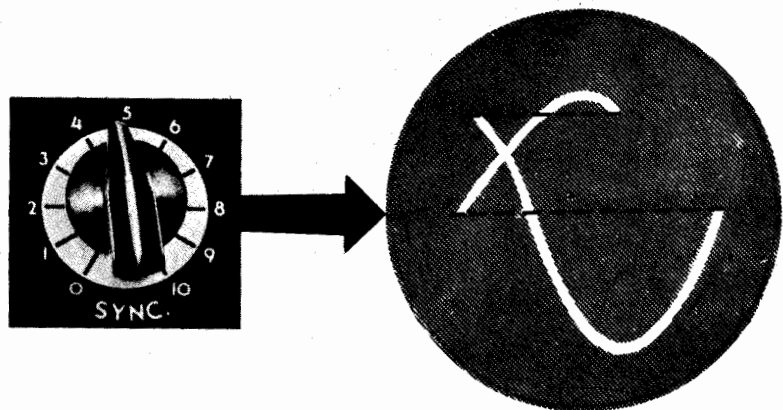

Fig. 1-14. Sync control is advanced too far.

### **PATTERN SIZE VERSUS INTENSITY-CONTROL SETTING**

Now that a sine-wave pattern is displayed on the screen, the trace appears much dimmer than the former small spot or horizontal line. If the sine-wave pattern fills most of the screen vertically, it appears very dim compared with a simple spot, because the electron beam has a much longer path to trace out. Also, each elementary spot along the trace now gets much less energy. It therefore becomes desirable to turn up the intensity control, in order to make the sine-wave pattern more clearly visible. However, the focus usually changes simultaneously, and in some scopes, there is also a tendency for the pattern to "bloom." This is the same reaction that occurs in many TV pictures when the brightness control is turned too high.

Therefore the intensity control is advanced as required, but not excessively. If the brightness of the pattern is not satisfac-

tory, check the ambient light in the shop. The scope may be facing a window, and high-level illumination is "washing out" the display. In that case, move the scope, or place a light hood around the scope screen.

Some scopes have brighter patterns (in good focus) than other scopes, depending on the amount of voltage applied to the accelerating anode. If the accelerating voltage is doubled from 1 kv to 2 kv, for example, the available pattern brightness is greatly increased. On the other hand, the vertical gain of the scope goes down, because the electron beam is "stiffer." Thus, in many service scopes, a compromise between pattern brightness, sensitivity, and cost is made.

Just as the spot or line discussed previously shifts vertically and horizontally on the screen when the centering (positioning) controls are adjusted, so does the present sine-wave pattern. As the scope *warms up*, the sine-wave pattern may *drift* vertically, horizontally, or both. In that case, readjust the centering controls as required.

## GAIN CONTROLS

### Vertical

Another difficulty may also arise at this point. Perhaps the pattern locks satisfactorily, but the vertical deflection is insufficient or excessive (Fig. 1-15). The vertical-gain control no doubt is set incorrectly. The vertical-gain control is adjusted normally for a pattern height of approximately  $\frac{3}{4}$  of full screen. Although the simplest scopes have a single vertical-gain control, most scopes have both step and vernier controls. The step control shown in Fig. 1-16 has two positions. If the input voltage is comparatively high, the step control is set to the "low" position, and vice versa.

The pattern in Fig. 1-16 is a multiple exposure, showing the effect of gain-control setting. By using suitable auxiliary equipment, such as electronic switches, two or more waveforms can be displayed simultaneously on a scope screen. Details about this will be discussed later.

Although the step gain control in Fig. 1-16 has two positions, other step gain controls may have three or four positions. The additional positions permit application of a wide range of input voltages, without overloading the vertical amplifier in the scope. All service scopes have vertical amplifiers. An amplifier is necessary because a cathode-ray tube is comparatively insensitive, and requires approximately 300 volts for adequate deflection. Because it is often necessary to investigate signal voltages as low as .02 volt, a high-gain vertical amplifier is required in practical work.

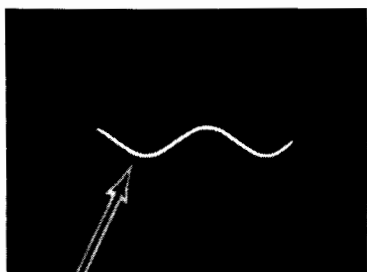

(A) Vertical-gain control set too low.

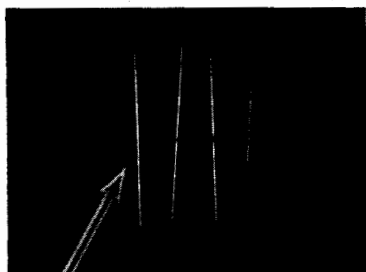

(B) Vertical-gain control set too high.

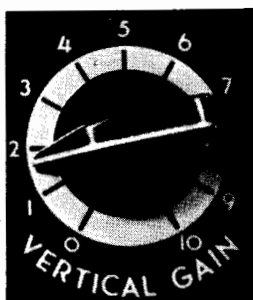

Fig. 1-15. Vertical-gain control incorrectly set.

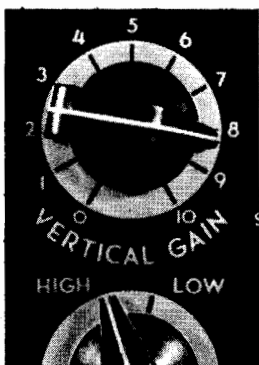
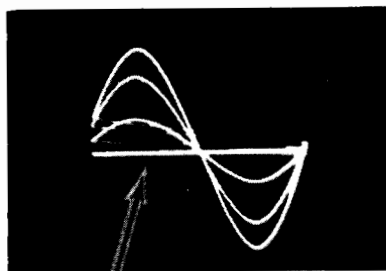

Fig. 1-16. Vertical-gain control effect.



In the simplest scopes, the vertical-gain control is a potentiometer (Fig. 1-17). This type of control is satisfactory only for low-frequency operation. A simple potentiometer control distorts a high-frequency waveform because of its stray capacitances. These are indicated in Fig. 1-18. Stray capacitance C1 is not of practical concern here, for high-frequency response is limited by stray capacitances C2, C3, C4, and C5. These act as small bypass capacitors within and around the gain control,

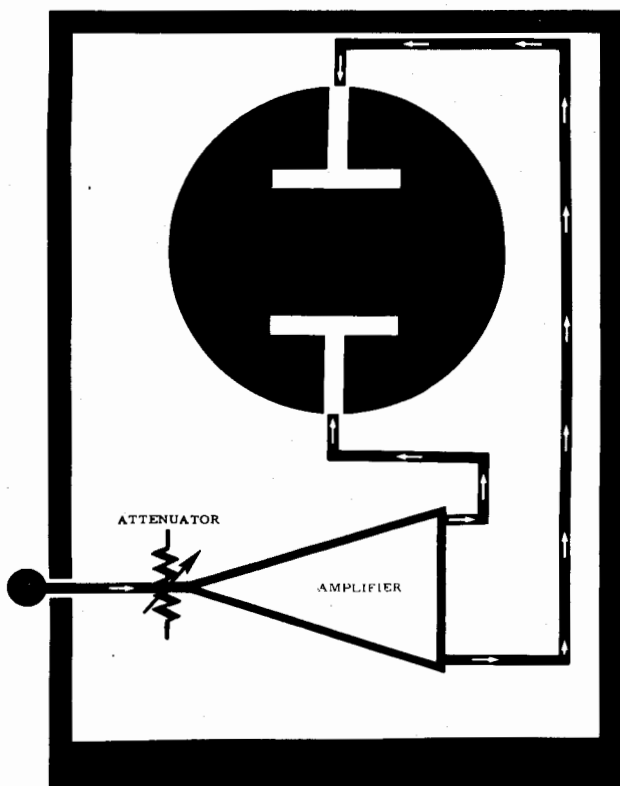

Fig. 1-17. Functional diagram of vertical-gain control.

and have more or less shunting action on high-frequency input signals.

This difficulty could be avoided if a low-resistance potentiometer, such as 1,000 ohms, could be used. This is not practical, however, because an input resistance of 1,000 ohms would cause serious *loading* in most electronic circuits under test. Ohm's law applies to AC voltages just as to DC voltages. If the input resistance is low, the scope connection draws a heavy current from the circuit under test, resulting in disturbed circuit action, and in turn, distorted waveforms.

For these reasons, the input resistance of a scope must be high. A typical value is 1 megohm. Suppose, however, that a simple potentiometer gain control (as in Fig. 1-18) had a resistance of 1 megohm. In that case, stray capacitances C2, C3, C4, and C5 would have excessive bypassing action at high frequencies. Undistorted waveforms would be passed only when

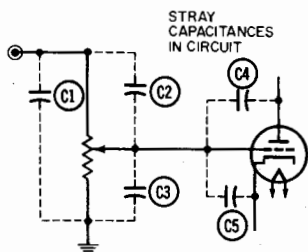
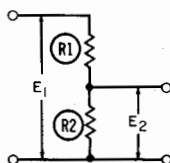

Fig. 1-18. Potentiometer gain control.

the gain control is set to maximum. At a reduced setting, more or less bypassing action would take place, and cause progressive distortion of the waveform. Therefore, a more elaborate gain-control configuration is required for controlling signal voltages at frequencies other than the power frequency.

### Step Gain

An interesting principle of circuit action makes possible a gain-control configuration having both high input resistance and distortionless attenuation. At low frequencies, a resistive voltage divider meets these requirements; at high frequencies,



$$E_2 = E_1 \frac{R_2}{R_1 + R_2}$$

(A) Low frequencies.

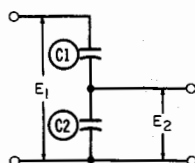

$$E_2 = E_1 \frac{X_{C2}}{X_{C1} + X_{C2}}$$

$$E_2 = E_1 \frac{C_1}{C_1 + C_2}$$

(B) High frequencies.

Fig. 1-19. Voltage dividers for low and high frequencies.

a capacitive voltage divider meets the requirements (Fig. 1-19). The resistive divider distorts high frequencies, and the capacitive divider distorts low frequencies. However, when the two configurations are combined, as in Fig. 1-20, all frequencies are passed without distortion. Trimmer capacitors C2 and C3 are

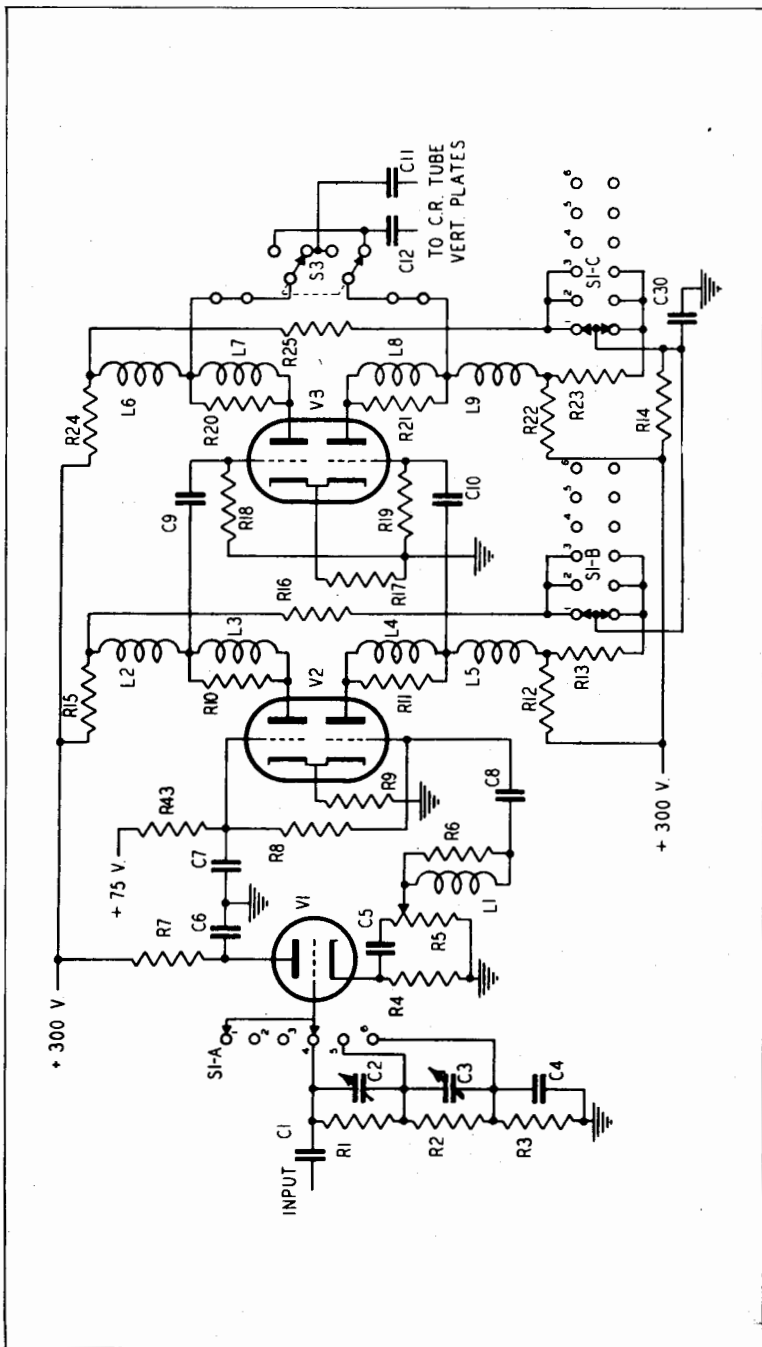

Fig. 1-20. Typical vertical-amplifier circuit.

used to balance the high- and low-frequency response. These capacitors are maintenance adjustments, and are located inside the scope case.

The step attenuator in Fig. 1-20 has three positions. The input signal is applied across series resistors R1, R2, and R3 (Fig. 1-20). The input resistance is 1.5 megohms for any of the three steps. When the step attenuator is set to a tap on the divider network, the output signal is reduced. Thus, cathode follower V1 is not overloaded, even though the input signal may be quite high. The step attenuator is merely set to a lower position.



Fig. 1-21. Step attenuator; with maximum input voltages marked.

The continuous (vernier) vertical-gain control is in a branch of V1. R5 is the vernier control. It has a comparatively low resistance, so that good high-frequency response is obtained for all positions of the control. Further, a cathode follower is an electronic impedance transformer. It steps down a high input resistance to a low output resistance. To summarize, the over-all action of the input system provides high input resistance, accommodates a wide range of input signal voltages, and permits the pattern to be adjusted to any desired height on the scope screen.

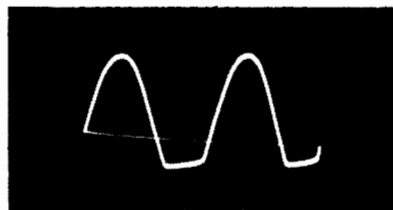

Fig. 1-22. Sine wave clipped by overloading.

The vertical amplifier, V2 and V3, is a push-pull amplifier like a video amplifier. This circuit will be discussed later. Here, the proper settings of step- and vernier-gain controls are of prime importance. In many scopes which have both of these controls, incorrect gain settings will overload the cathode follower and cause the waveform to be clipped (Fig. 1-22). This

means that the step attenuator has been set too high, and the vernier attenuator too low. Distortion is corrected by changing the step control to a lower setting, and advancing the setting of the vernier control. Clipping is a distortion which can be quite confusing to beginners, if it is not understood.

### Horizontal

Although vertical deflection is satisfactory, the pattern may be excessively compressed or expanded horizontally (Fig. 1-23). In that case, the horizontal-gain control is adjusted as required. Less elaborate scopes have a simple potentiometer-type horizontal-gain control only; others have both step- and continuous-gain controls. In most cases, the horizontal-step control merely is a resistive divider network. However, a few service scopes have the same type of compensated step control as used in the vertical section. These scopes are somewhat more expensive.

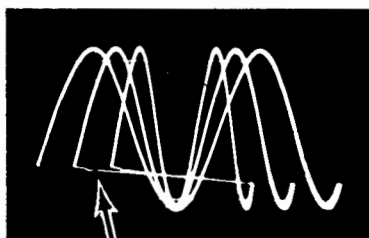

(A) Horizontal-gain control effect.

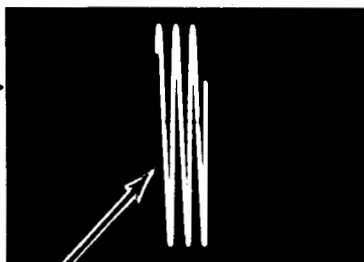

(B) Control set too low.

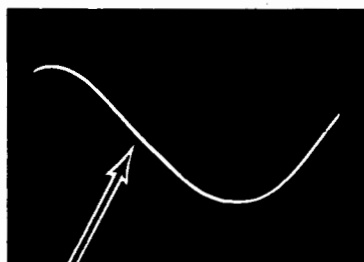

(C) Control set too high.

Fig. 1-23. Effects of horizontal-gain control.

For most test work, a good high-frequency response in the horizontal section is not needed. Therefore, the horizontal-amplifier circuit is often simpler than the vertical section. A typical horizontal-input and -amplifier circuit is shown in Fig. 1-24. The step attenuator has two positions. A vernier horizontal-gain control is in the cathode circuit of the cathode follower. Its output is coupled to a paraphase amplifier, which changes a single-ended input into a double-ended output.



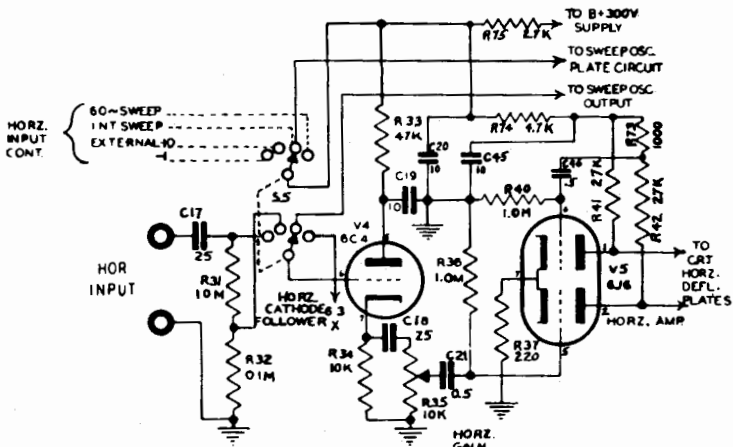

Fig. 1-24. Typical horizontal-amplifier circuit.

### FREQUENCY CONTROL

It is generally customary to display two cycles of the signal in the pattern. This is done by suitable adjustment of the sawtooth-frequency control. Consider the display of two cycles in a 60-cycle signal. When the sawtooth-frequency control is adjusted to 30 cycles, the signal goes through two excursions during one trace interval, and two cycles of the signal are displayed. Similarly, when the sawtooth frequency is adjusted to 20 cycles, three cycles of the signal are displayed.

A typical sawtooth oscillator is shown in Fig. 1-25. This is a free-running oscillator which feeds a sawtooth voltage to

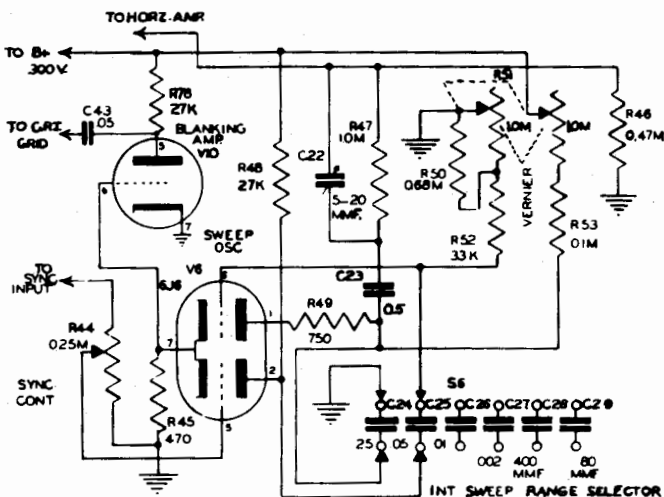

Fig. 1-25. Typical sawtooth (sweep) oscillator and blanking amplifier.

the horizontal amplifier. The step control selects a pair of capacitors ranging in value from 80 mmf to 0.25 mfd. Higher values of capacitance provide a lower sawtooth frequency. The vernier frequency control is a pair of ganged potentiometers. Higher values of resistance provide a lower sawtooth frequency. The vernier control "fills in" between the various positions of the step control. The sawtooth frequency can be adjusted from 10 cycles to 100 kc.

### RETRACE BLANKING

Blanking amplifier V10 in Fig. 1-25 eliminates the retrace line in pattern displays. During sawtooth retrace time, a positive pulse voltage is generated across cathode resistor R45. This pulse voltage is fed to the grid of the blanking-amplifier tube, amplified, and reversed in polarity. This negative impulse is applied to the grid of the cathode-ray tube, and cuts it off during the retrace interval. For example, the pattern shown in Fig. 1-22 has a visible retrace, while the pattern in Fig. 1-15 does not. Some scope operators prefer a blanked-out retrace, while others occasionally use the retrace to expand waveform

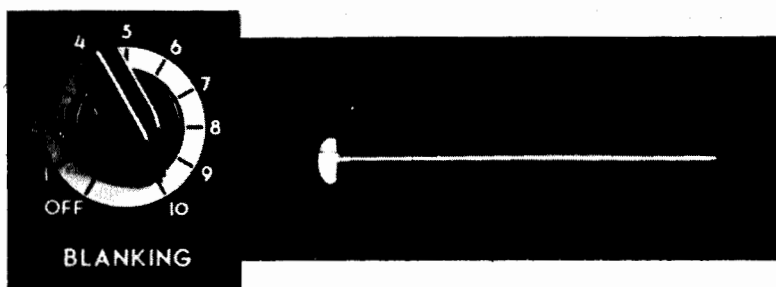

Fig. 1-26. Retrace blanking control, and pattern resulting from misadjustment.

detail. Therefore, a scope may have a switch for disabling the retrace-blanking circuit when desired.

The retrace-blanking switch in some scopes, is combined with an adjustable blanking control, as shown in Fig. 1-26. This is a phasing adjustment, which is set to bring the blanking voltage "in step" with the retrace. If the blanking control is misadjusted, the retrace is partially or completely unblanked, and a "mushroomed" spot may appear at the end of the trace, as illustrated in Fig. 1-26. A blanking control often requires re-adjustment when the sawtooth frequency is changed. Although a particular setting may be satisfactory at low deflection rates, another setting may be found necessary at high deflection rates.



Fig. 1-27. Severe horizontal nonlinearity.

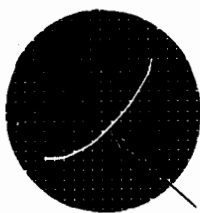

Fig. 1-28. Nonlinear amplification present.

### HORIZONTAL NONLINEARITY

Sometimes horizontal deflection is nonlinear. The pattern appears cramped at one end, and expanded at the other end (Fig. 1-27). This trouble can be caused by a weak tube in the horizontal-amplifier or the sawtooth-oscillator section, by low plate-supply voltage to either section, or by defective capacitors, particularly coupling capacitors. In Fig. 1-25, C22 is a maintenance control which is set for best horizontal linearity.

Amplifier linearity can be checked by applying a 60-cycle voltage to both the horizontal- and vertical-input terminals of the scope. The horizontal-function switch is then set to a horizontal-input position—either “low” or “high” as required to accommodate the input voltage level. The vertical- and horizontal-gain controls are then adjusted to obtain about  $\frac{3}{4}$  of full-screen deflection. In the ideal situation, a perfectly straight diagonal line appears on the screen. However, nonlinearity in either the vertical or horizontal amplifier, or both, results in a curved diagonal trace (Fig. 1-28).

### CALIBRATION AND PEAK-TO-PEAK VOLTAGE MEASUREMENTS

An oscilloscope is a voltmeter which displays instantaneous, peak, and peak-to-peak voltages. It also displays the rms values of some waveforms. The meaning of instantaneous values is evident in Fig. 1-29. Each dot in the sine waveform represents

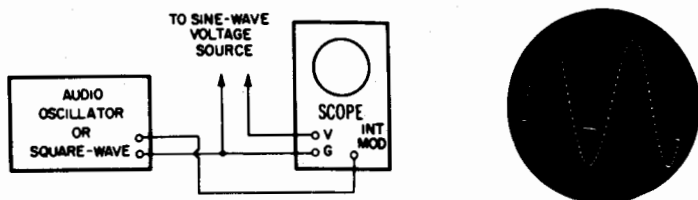

Fig. 1-29. Instantaneous voltages “marked” and timed by intensity modulation of the scope.

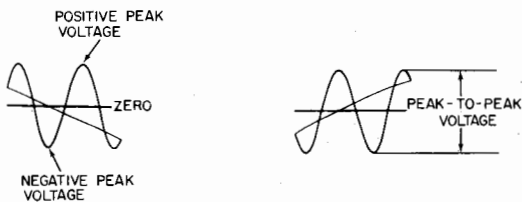

Fig. 1-30. Meaning of positive-peak, negative-peak, and peak-to-peak voltages.

a particular instantaneous voltage. This is, in practice a form of time calibration, which will be explained in more detail later. It is pertinent to note here, however, that certain instantaneous voltages have the specific designations of positive-peak voltage, negative-peak voltage, and peak-to-peak voltage (Fig. 1-30).

Peak-to-peak voltages are specified in receiver service data. They are usually measured on the scope screen, although a peak-to-peak VTVM can be used if the impedance of the circuit under test is not too high. (A VTVM loads a circuit more than a scope—provided, of course, the scope is applied properly.) To calibrate a scope for peak-to-peak voltage measurements, its sensitivity for the chosen setting of the vertical-gain controls is determined. A known peak-to-peak voltage is applied to the vertical-input terminals of the scope, and the resulting number of divisions are noted for deflection along the vertical axis. Thus, if a 1-volt peak-to-peak signal is applied to

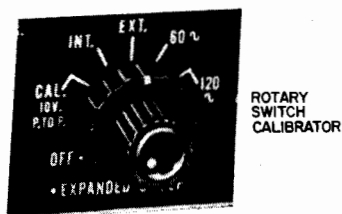
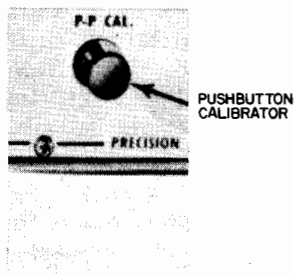
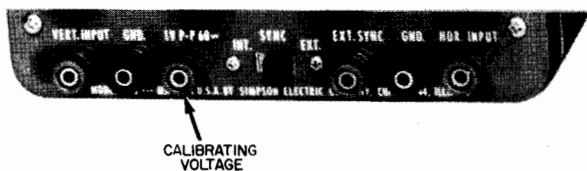

Fig. 1-31. Typical calibrating facilities.

the scope, and 10 divisions of vertical deflection are observed, the vertical-gain controls are set for a sensitivity of 0.1 volt peak-to-peak per division.

Many scopes have provisions for applying a known peak-to-peak voltage to the vertical amplifier. Three typical examples are illustrated in Fig. 1-31. A binding post provides a 1-volt peak-to-peak source; a pushbutton provides a 1-volt peak-to-peak source and automatically connects it to the input of the vertical amplifier when the button is pressed; a rotary switch automatically connects a 10-volt peak-to-peak source to the input of the vertical amplifier when turned to the Cal. position. Some scopes must be calibrated by using an external voltage source; however, this procedure is not difficult to perform.

Consider the voltage from an ordinary heater string. This voltage has an rms value of 6.3 volts. Because it is a sine-wave voltage, its peak-to-peak value is found by multiplying 6.3 by

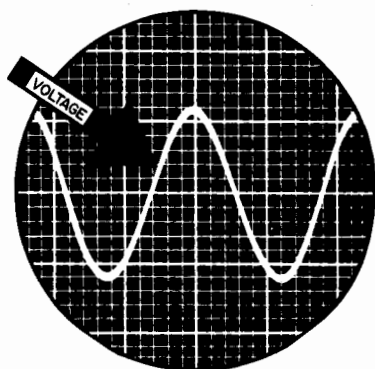

Fig. 1-32. An excursion of 12 divisions.

2.83, or it has an amplitude of 17.8 volts peak-to-peak, which is usually rounded off to 18 volts peak-to-peak in practical work. Thus, if the vertical input of the scope is connected to a heater line, an 18-volt peak-to-peak voltage is being applied to the vertical amplifier.

Consider an arbitrary calibration voltage, such as 12 volts peak-to-peak, being applied to the vertical-input terminals. If the vertical-gain controls are adjusted to make the voltage waveform extend over 12 divisions vertically (Fig. 1-32), the scope is calibrated for 1 volt peak-to-peak per division. In turn, each major division on the graticule marks off 5 volts peak-to-peak. In this manner, a scope is calibrated easily, for any convenient source of peak-to-peak voltage. Note carefully, however, that a service-type VOM reads rms voltage of sine waves. The peak-to-peak voltage of a sine wave is 2.83 times the rms reading.

## COMPLEX WAVEFORMS

Although a sine wave is symmetrical, most waveforms encountered in electronic test work are unsymmetrical. A pulse waveform, such as shown in Fig. 1-33 is unsymmetrical, and in turn, has a positive-peak voltage which is *not* the same as its negative-peak voltage. Nevertheless, *once a scope has been calibrated with a sine wave, peak-to-peak voltages of complex waveforms can also be measured on the screen.*

Fig. 1-33. Voltages of a pulse waveform.

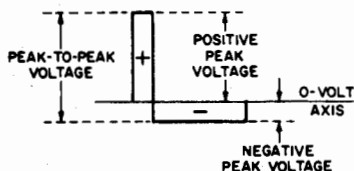

A square waveform is a complex symmetrical waveform, and its voltage is measured in peak-to-peak values. Fig. 1-34 shows a square wave which has the same peak-to-peak voltage as the sine wave illustrated; however, the rms voltage of the square wave is different from that of the sine wave. Note carefully that service-type VOM's respond differently to these two waveforms. Even though they have the same peak-to-peak voltage, a VOM indicates different voltages for the two waves. A VOM indicates the true rms voltage of the sine wave, but does not indicate correctly when a square wave is measured.



Fig. 1-34. These waveforms have the same peak-to-peak voltages, but their rms values are different.

A peak-to-peak reading VTVM indicates, of course, the true peak-to-peak voltage of any type of waveform. Interested readers may refer to *101 Ways to Use Your VOM and VTVM*, and *101 More Ways to Use Your VOM and VTVM*.

Once the sensitivity of a scope is adjusted for a certain number of peak-to-peak volts per division, peak voltages can be measured as easily as peak-to-peak voltages. An example is seen in Fig. 1-35. With no input signal, the scope displays only a horizontal trace. This is the beam-resting, or zero-volt

level. When a complex waveform is displayed, it appears partly above the zero-volt level and partly below. The number of divisions from the zero-volt level to the positive peak of the waveform indicates its positive-peak voltage. Likewise, the number of divisions from the zero-volt level to the negative peak of the waveform indicates its negative-peak voltage. Peak voltages are measured in the same units as peak-to-peak voltages.

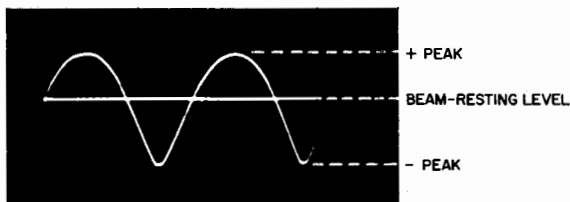

Fig. 1-35. The beam-resting level of a scope shows the positive and negative portions of a waveform.

### STEP ATTENUATORS

Step attenuators are usually *decade* devices. They attenuate a signal voltage by 0.1, 0.01, or 0.001. Conventional step markings are X1, X10, X100, and X1000. Decade attenuation facilitates measurements of peak-to-peak voltages. For example, suppose that the vertical step attenuator is set to the X10 position, and the vernier attenuator is adjusted to provide a sensitivity of 1 volt peak-to-peak per division. If a waveform voltage is applied to the vertical-input terminals, and the pattern is off-screen at top and bottom, it is a simple matter to turn the step attenuator to the X100 position. This brings the pattern within screen limits, and changes the sensitivity to 10 volts peak-to-peak per division.

If the applied waveform voltage does not produce sufficient vertical deflection, the step attenuator can be turned to the X1 position. This increases the pattern height ten times, and changes the sensitivity of 0.1 volt peak-to-peak per division. In summary, adjustment of the vertical step attenuator does not change the basic calibration of the scope. However, such adjustment makes possible quick measurement of peak-to-peak voltages over a wide range, from a single calibration.

### DC VERSUS PEAK-TO-PEAK VOLTS

Many technicians use DC scopes. A DC scope has a low-frequency response down to zero frequency, or DC. On the other hand, an AC scope has some definite low-frequency limit,

such as perhaps 20 cycles. The typical response of a DC scope is illustrated in Fig. 1-36. If a 10-volt battery, for example, is connected to the vertical-input terminals, a positive polarity deflects the beam upward, and the beam remains in its deflected position until the DC voltage is removed. Similarly, when the terminal polarity is reversed, the beam deflects downward from its resting position, by the same amount as it was deflected upward.

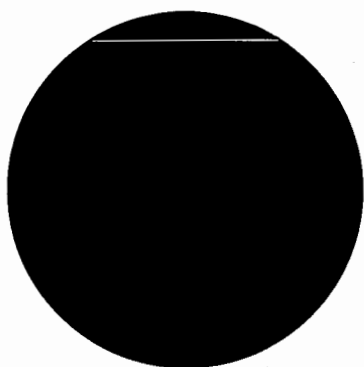

(A) +10 volts applied to vertical input.

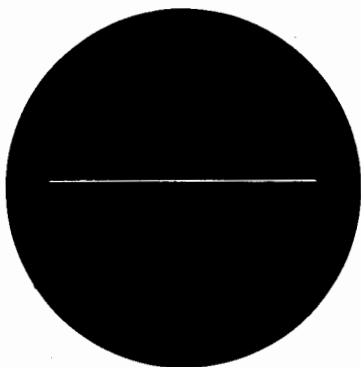

(B) 0 volts applied to vertical input.

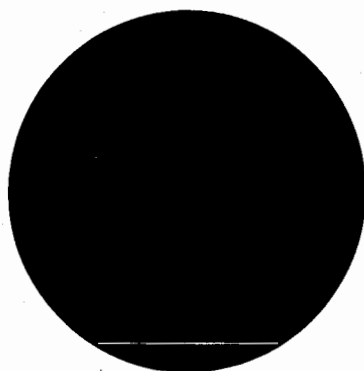

(C) -10 volts applied to vertical input.

Fig. 1-36. Response of a DC scope.

What is the relation between DC deflection and peak-to-peak AC deflection? The two deflections are the *same*. In other words, if the beam deflects by the amount shown in Fig. 1-36 for an input of +10 volts DC, the beam will deflect by the same amount for a 10-volt peak-to-peak AC input. Hence, a DC scope can be calibrated either with a DC- or an AC-voltage source.

Many waveforms in electronic circuits consist of an AC voltage *with* a DC voltage component also. The output from a video detector, the signal across a cathode resistor, and the



signal at the collector of a transistor are typical examples. When such voltages are applied to a DC scope, the response takes place as shown in Fig. 1-37. The beam level rises from its resting position (or falls) in correspondence with the DC component. *The AC waveform is displayed on the DC level.*

All DC scopes have switching facilities to change from DC to AC response. Thus, in Fig. 1-37, if the scope is switched

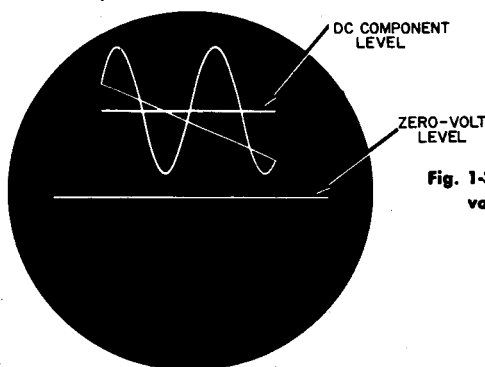

Fig. 1-37. Response of DC scope to AC voltage with a DC component.

to the AC response, the AC waveform is unchanged, but it drops down and is centered on the zero-volt level. In other words, the DC component is removed during AC-scope operation. Changeover from DC to AC response is accomplished by switching a series blocking capacitor into the vertical-input circuit.

## SYNC FUNCTION

### External

The majority of scope tests are made with the pattern locked by internal sync. Or, the synchronizing voltage is obtained internally from the input signal voltage. For some tests, a sync voltage separate from the signal voltage is required. The signal voltage characteristics may be unsuitable for locking the pattern, or circuit phases may be of interest. For example, when the composite video signal is displayed on 60- or 30-cycle deflection, it is often found difficult (and sometimes impossible) to lock the pattern on internal sync. This occurs because the horizontal sync pulses are as high as the vertical sync pulses, and the scope's sync circuits are not able to separate the vertical from the horizontal pulses.

In this situation, the pattern can be locked tightly by setting the selector switch to the Ext. Sync position, and connecting a lead from the external sync terminal to a 60-cycle source, such as the vertical blocking-oscillator circuit. Another satisfactory

solution is often possible by setting the selector switch to the Line Sync position. In this case, the sync circuits of the scope are locked to the 60-cycle power-line frequency.

An example of phase investigation is illustrated in Fig. 1-38. Here, the signal progression is being checked along an artificial delay line, such as is found in pattern generators. Each section of the delay line changes the signal phase by a specified time interval, as required for normal generator operation. In order to test these time intervals with a scope, the function control is set to the Ext. Sync position. A test lead is run from the Ext. Sync terminal to the input (or output) end of the delay line. Then, as the vertical-input lead is moved progressively from one line section to the next, the exact phase delay in each case is displayed on the scope screen.

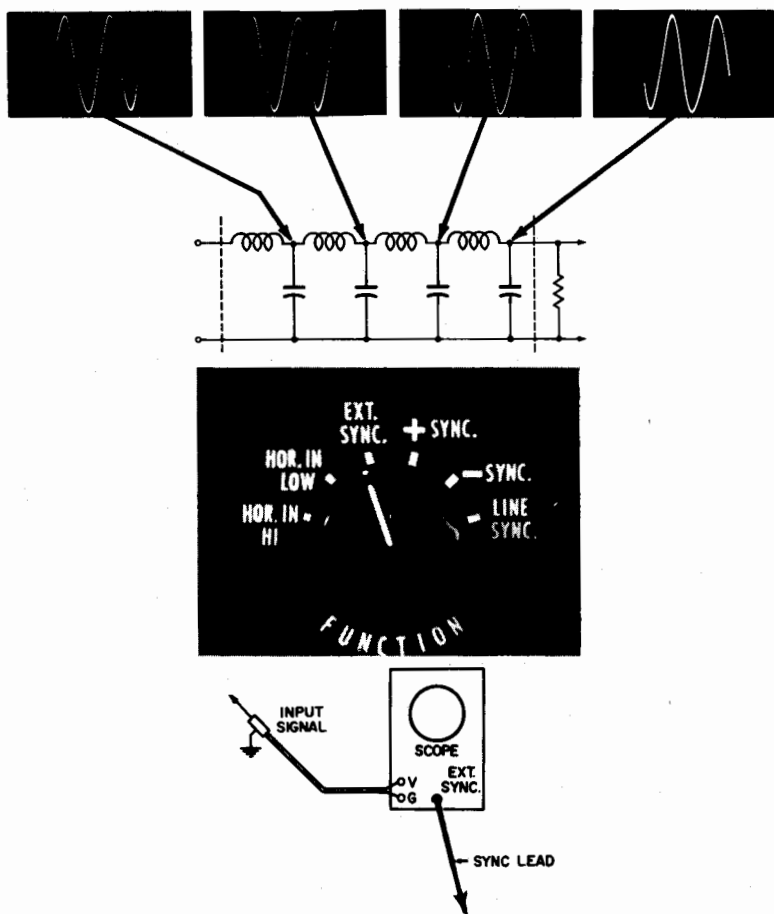

Fig. 1-38. External sync is used when checking out a generator delay line.

Phase investigations are occasionally of great concern when checking audio amplifiers which have feedback networks. Incorrect phase shift can cause distortion or unstable operation, sometimes with violent oscillation. A conventional amplifier stage steps up the signal voltage and reverses its phase. Any sync function can be used when measuring stage gain, merely by comparing the heights of the input and output patterns of the amplifier. The *phase shift* from input to output, however, can be checked only by utilizing the external sync function of the scope.

### **Automatic**

Completely automatic sync is a fiction. However, some features in a scope help to make sync action semiautomatic. Preset sweep positions (30 cycles and 7,875 kc) speed up the setting of deflection controls in TV test work. Diode limiters are sometimes included in the sync channel, so that the sync-amplitude control does not have to be reset so often when displaying widely different waveshapes.

The closest approach to automatic sync is triggered sweep, as provided in a few service scopes. Triggered sweep is obtained by biasing the sawtooth deflection oscillator, so that it becomes a one-shot oscillator. In other words, one sawtooth waveform is generated each time the leading edge arrives. The trigger level is set manually by a Trigger-Sweep control, as in Fig. 1-39.

Besides the ability of triggered sweep to expand a small part of a waveform, as if it were inspected under a magnifying glass, there is also the automatic-sync aspect of triggered sweep action. That is, the horizontal-sweep frequency can be set to any desired value, and the pattern is always in sync. As the sweep frequency is increased, the expansion becomes greater. The only nonautomatic aspect of triggered sweep is that the Trigger-Sweep control must be reset for different waveshapes.

In Fig. 1-39, when the Trigger-Sweep control is turned completely to the left, the cut-off bias is removed from the sawtooth oscillator, and ordinary sawtooth deflection takes place. By advancing the horizontal-gain control to maximum, a certain amount of horizontal expansion is possible when ordinary sawtooth deflection is used. However, the obtainable expansion is considerably less than when triggered sweep is used.

Also shown in Fig. 1-39 is a Magnifier Positioning control. A sweep magnifier is used like triggered sweep to obtain horizontal expansion of a waveform, but its basic action is different, however. In order to use a sweep magnifier, a waveform is displayed on ordinary sawtooth sweep, and then the function switch is set to the Sweep Magnifier position. This has the effect

of changing the sawtooth deflection wave into a triangular pulse, as depicted in Fig. 1-40. Also, by turning the Magnifier Positioning control, the triangular sweep pulse can be phased at any point of the waveform. The deflecting action of the triangular pulse is that of expanding the selected portion of the waveform to full horizontal screen width.

In service scopes, the ordinary sawtooth deflection voltage is changed into a triangular pulse simply by greatly overdriving

**Fig. 1-39. Display of a pulse waveform on ordinary sawtooth sweep, and on triggered sweep.**

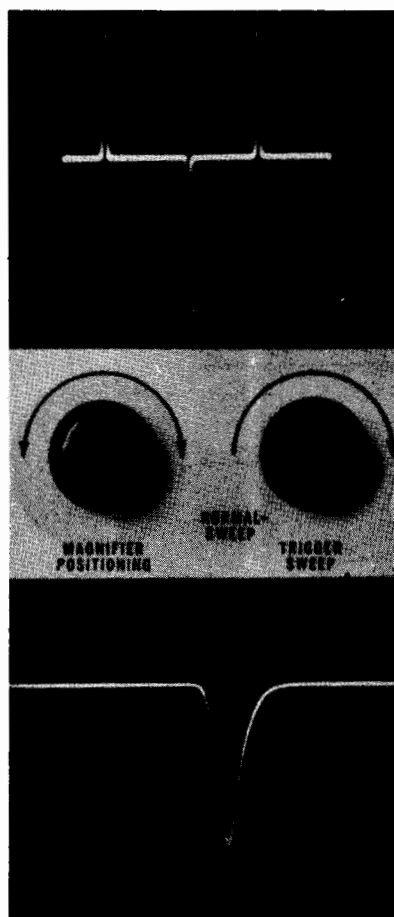

the horizontal-output amplifier. The Sweep Magnifier control adds more or less DC components to the overdriving sawtooth, which, in effect, phases the resulting triangular pulse to a selected point on the waveform under investigation.

The chief differences between triggered sweep and magnified sweep are:

1. Triggered sweep provides semiautomatic sync. It permits horizontal expansion of a waveform to any desired extent, within the available speed of the sawtooth oscillator. Expansion *always* starts at the leading edge of the waveform. Nonrepetitive signals can be displayed.
2. Magnified sweep does not provide semiautomatic sync. It permits horizontal expansion of a waveform to the extent of the overdrive voltage available in the scope. Expansion starts at any chosen point on the waveform.

In service scopes, the amount of expansion which is practical on either triggered sweep or magnified sweep may be limited by the high voltage applied to the CRT. Expansion means a dimmer trace, because the electron beam is moving faster. If the expansion is quite considerable, the pattern can become invisible unless adequate accelerating voltage is available for the CRT.

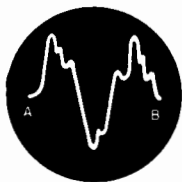
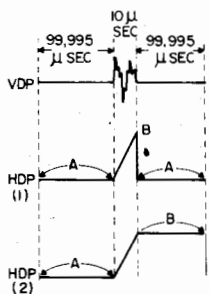

Fig. 1-40. Sweep magnifier action. Suitable for repetitive waveforms only.

## LISSAJOUS PATTERNS

A Lissajous pattern was illustrated in Fig. 1-6. This was a simple circular pattern formed by 60-cycle sine-wave voltages. Such patterns are displayed by feeding sine-wave voltages to both the vertical and horizontal amplifiers. Because many scopes have a 60-cycle sweep position on the function switch, such tests can be made readily by utilizing this function. When any 60-cycle sine-wave voltage is applied to the vertical-input terminals, a Lissajous pattern then appears on the scope screen.

The pattern shows the phase of the vertical signal with respect to the horizontal signal. Progressive phases are illustrated in Fig. 1-41. Scopes which have internal 60-cycle sine-wave deflection often have a Sweep-Phasing control. If that is the case, as the Sweep-Phasing control is turned, the Lissajous pattern goes through the various shapes shown in Fig. 1-41. A circular pattern provides a good check for sine-wave purity.

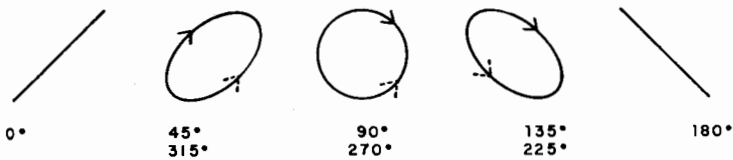

Fig. 1-41. Lissajous patterns show phase difference between two sine waves.

Further, if there are harmonics in the 60-cycle voltage to the vertical amplifier, to the horizontal amplifier, or both, a perfect circle cannot be obtained. Irregularities are seen instead.

Lissajous patterns can be obtained, of course, at any frequency within the response range of the scope. The principle of pattern development is the same, regardless of frequency. Fig. 1-42 illustrates how in-phase deflection voltages on the vertical and horizontal CRT plates produce a straight line. Similarly, Fig. 1-43 shows how a  $90^\circ$  phase difference produces a circular pattern. When one of the frequencies is double, triple, or quadruple the other frequency, crossover patterns result. If the two frequencies are not integrally related, the pattern is not fixed, but moves through successive phase sequences.

### DISPLAY OF NARROW PULSES

As seen in Fig. 1-38, function switches provide a choice of positive or negative internal sync. When a sine wave or square

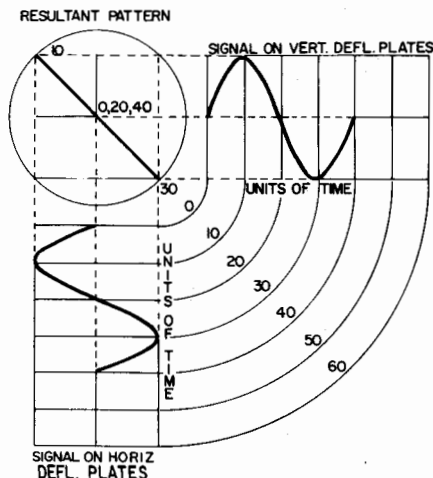

Fig. 1-42. Showing how in-phase sine waves form a straight-line cyclogram.

wave is being displayed, the pattern locks equally well on either positive or negative sync. If a narrow pulse is being displayed, however, sync lock will be much tighter when the appropriate sync polarity is used. Positive pulses lock best on positive sync, and negative pulses lock best on negative sync. The reason for this is that a very narrow positive pulse has a very small negative peak voltage (and vice versa). Hence, if negative sync is used when a narrow positive pulse is displayed, there is very little voltage available for locking.

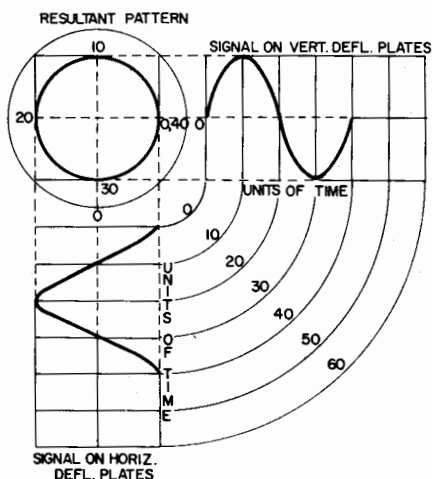

Fig. 1-43. Sine waves 90 degrees out of phase form a circular cyclogram.

Any complex waveform distributes itself above and below the zero-volt level to make the positive area equal the negative area. This is a direct consequence of the fact that the average value of an AC waveform is zero, or there is just as much current flow in the positive direction as in the negative direction. Thus, the area of the positive half cycle is equal to the area of the negative half cycle, although the peak voltages are vastly different. A scope displays voltage along the vertical axis, and time along the horizontal axis (when sawtooth deflection is used). Voltage multiplied by time gives electrical quantity, and the product is an area. Therefore, positive and negative areas of the waveform are necessarily equal.

### DISPLAY OF SQUARE WAVES

The square wave is one of the basic complex waves. While a sine wave has only one frequency, a square wave has many frequencies—theoretically an infinite number. The repetition

rate of a square wave (often called the "frequency of the square wave") is the same as its fundamental frequency. Square waves are useful in test work because a single test suffices to show how a circuit responds to a spread of frequencies, both with regard to voltages and phases. Key reproduced square waves are shown, in Fig. 1-44.

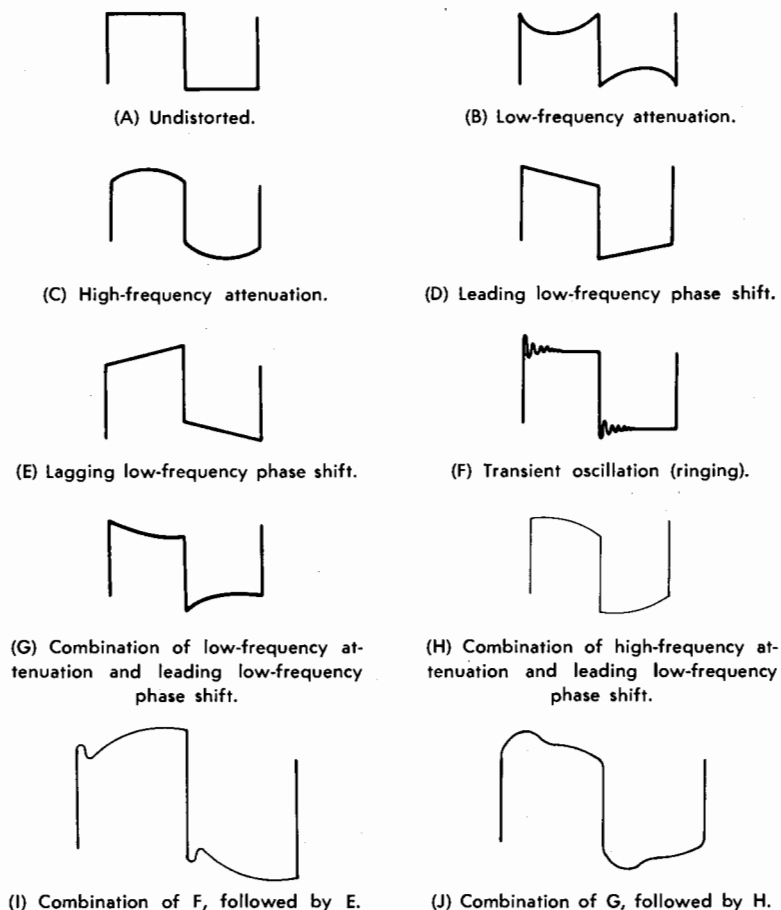

Fig. 1-44. Key square-wave reproductions.

All square waves, when carefully inspected, are found to depart more or less from an ideal square wave having perfectly square corners with zero rise and fall times. It is impossible to generate a perfect square wave, because of the effect of weakening the higher harmonics to a greater or lesser extent. However, a good generator provides a square-wave output which can be considered as ideal for most applications.



Differentiation and integration occur in RC circuits, as shown in Fig. 1-45. It is a basic law that if differentiation takes place in one part of a circuit, integration must take place in another part. This is the case because the sum of the waveforms around the circuit must add up to cancel the applied square-wave voltage. This is called Kirchoff's law, which is almost as fundamental as Ohm's law in analysis of circuit action.

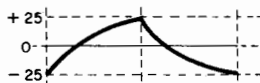
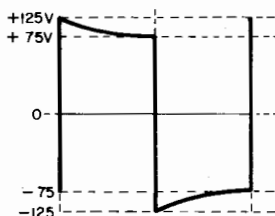
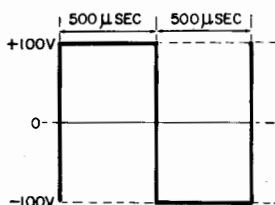
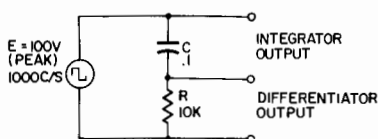

Fig. 1-45. RC differentiator and integrator action on a square wave.

The result of a typical square-wave test is seen in Fig. 1-46. Here the input and output voltages of the unit under test are shown superimposed. There is a substantial loss in square-wave voltage through the unit under test. Integration is prominent, with a slight differentiation evidenced by the small downhill tilt of the top in the reproduced square wave. When both integration and differentiation occur, the two actions occur in successive circuit sections. It is possible for the integration in one section to cancel the differentiation in a following section in

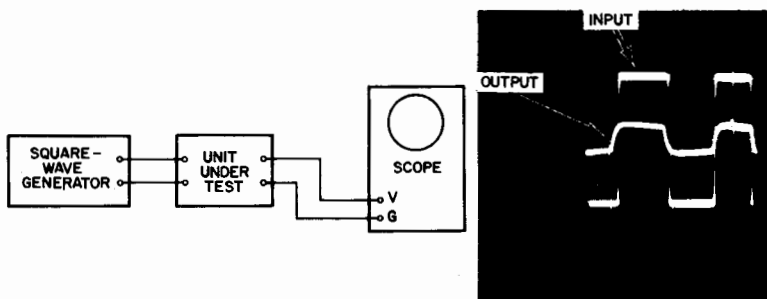

Fig. 1-46. Result of a typical square-wave test.

order to obtain an undistorted output. Vertical-sweep circuits in TV receivers afford a practical example of this circuit action.

### FLUCTUATING LINE VOLTAGE

Line-voltage fluctuation can be a problem in heavily industrialized or remote rural areas. Appreciable variation in line voltage can cause pattern jumping, as in Fig. 1-47. If that is the case, the voltage must be stabilized. The best method is to use an automatic line-voltage regulating transformer to power the



Fig. 1-47. Pattern jumping, caused by fluctuating line voltage.

scope and the equipment under test. Although such transformers do not completely smooth out rapid fluctuations, pattern stability is greatly improved.

A few service scopes have regulated power supplies. In such a case, the automatic line-voltage regulating transformer is required only to power the equipment under test.

## CHAPTER 2

# Using Oscilloscope Probes

A scope has appreciable input capacitance, which is about 20 or 30 mmf at the vertical-input terminal. Test leads or a coaxial cable must be connected to the input terminal for actual test work (Fig. 2-1). Open test leads may be suitable for testing in TV signal circuits, such as the grid of a video amplifier, or sync separator. The open leads often pick up excessive hum voltage and flyback-pulse interference. It is therefore standard practice to make all scope tests with a coaxial input cable to the vertical-amplifier terminals.

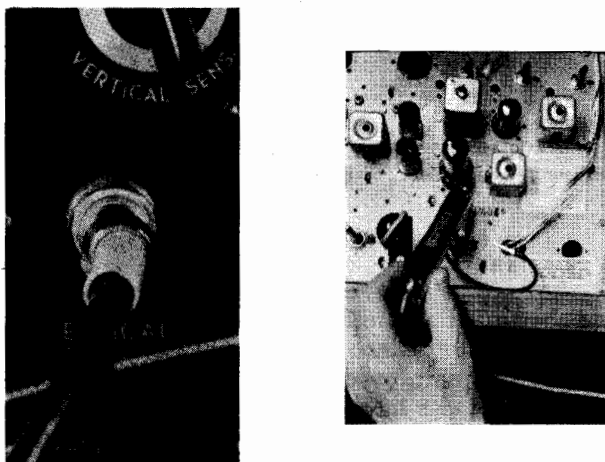

Fig. 2-1. Coaxial cable prevents pickup of stray fields.

When a coaxial input cable is used, the total input capacitance to the scope becomes about 100 mmf. This capacitance does not cause objectionable circuit loading when testing across a cathode resistor, for example, but it will disturb many video and sync circuits seriously. Fig. 2-2 shows how a sync pulse can be distorted objectionably by shunting excessive capacitance across the circuit under test. The total input capacitance

to the scope is imposed when a direct probe (straight-through connection) is used.

### LOW-CAPACITANCE PROBE

It is standard practice to use a low-capacitance probe instead of a direct probe, in order to avoid waveform distortion caused by circuit loading. The most common type of low-capacitance



(A) Normal video signal.

(B) Signal distorted by integration.

Fig. 2-2. Typical result of circuit loading.

probe is a compensated attenuating device. This type of probe reduces the signal voltage, and in turn, reduces the input capacitance to the scope. Most probes are adjusted to attenuate the signal voltage to 0.1 of its source value, and to reduce the scope input capacitance to 0.1 of the value imposed by a direct probe. The input impedance to the scope is thus effectively increased ten times.

### Configuration

A typical configuration for a low-capacitance probe is shown in Fig. 2-3. The values of  $R_1$  and  $R_2$  depend upon the scope's input resistance. A typical scope has an input resistance of

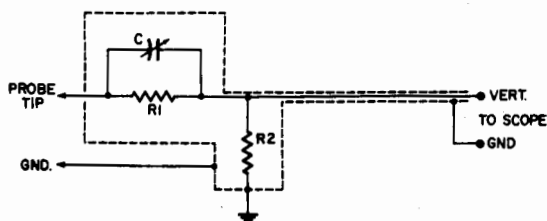

Fig. 2-3. Low-capacitance probe configuration.

1 megohm. The probe does not stand alone in actual operation, for  $R_2$  is shunted by the scope's input resistance. Thus, if  $R_2$  has a value of 1 megohm, its effective resistance value becomes 0.5 megohm when it is connected to the input cable of the scope.

In order to get a 10-to-1 attenuation, R1 is made nine times the effective value of R2. R1 is therefore 4.5 megohms for the example cited. The total input resistance to the probe (when connected to the cable) is 5 megohms. The voltage drop across R2 equals  $0.5/5$ , or 0.1 of the input voltage to R1. Thus, a 10-to-1 attenuation occurs. This attenuation is observed only at low frequencies, such as 60 cycles, because the input capacitance of the cable and scope bypass higher frequencies more or less.

The probe must be compensated in order to obtain proper attenuation and distortionless signal passage. This is the function of trimmer capacitor C. The probe will have a 10-to-1 attenuation at high frequencies when C is adjusted correctly. The time constant of C and R1 must be equal to the time constant of the effective input resistance and capacitance to the scope. As a practical example, assume that the input capacitance at the cable is 100 mmf. The time constant to the scope is then  $0.5 \times 10^6$  multiplied by  $100 \times 10^{-12}$ , or  $50 \times 10^{-6}$  second. Thus the time constant is 50 microseconds. Hence, the time constant of R1 and C must also be adjusted to 50 microseconds. Inasmuch as R1 has a resistance of 4.5 megohms, C must have a value of about 11 mmf. A trimmer capacitor is used so that an exact adjustment can be made.

### **Adjustment**

There are two principal methods of adjusting a low-capacitance probe. The first makes use of square waves. If a 15-kc square wave is fed from a square-wave generator to the low-C probe, the reproduced square wave changes shape on the scope screen as C is adjusted. When the capacitance is too high, the square wave appears differentiated. When it is too low, the square wave appears integrated. Correct adjustment of C provides distortionless reproduction of the square wave.

All square-wave generators do not provide a perfect output. It is advisable first to check the generator waveform by connecting the direct probe of the scope to the generator output terminals. Observe the waveform and then duplicate this waveform with the low-C probe connected to the scope input cable. The probe can be adjusted properly regardless of generator distortion. It is necessary only to reproduce the same waveform which is applied by the generator.

The second method of probe adjustment is a two-frequency test. For example, a 60-cycle sine-wave voltage is applied to the probe, and the resulting vertical deflection is noted. Next, a 15-kc sine-wave voltage is applied to the probe from an audio oscillator. The audio oscillator is set for the same output voltage as in the 60-cycle test. Also, capacitor C is adjusted

to give the same vertical deflection on the scope screen as before. Output voltages at 60 cycles and at 15 kc can be checked with the scope, using a direct probe.

Most service scopes are suitable for operation with low-C probes, but there are a few exceptions. A scope must have a step attenuator which provides a fixed value of input resistance and capacitance on each step in order to operate properly with a low-C probe. However, a low-C probe cannot be matched to a scope which has merely a potentiometer for the vertical-control gain. While the probe can be adjusted for proper response at one gain setting, another gain setting may not match the probe and therefore more or less severe distortion results.

Low-capacitance probes are useful over the frequency response range of the scope. If the scope has a flat response from 20 cycles to 2 mc with a direct probe, it will have the same frequency response when a low-C probe is used. The probe does not change the existing frequency response of a scope, but merely steps up the input impedance. For these reasons a low-C probe is used to test sync, video-amplifier, horizontal-oscillator and AFC, and sweep circuits. The frequencies in these circuits range from 60 cycles to 15 kc, plus harmonic frequencies up to 1 or 2 mc.

The permissible voltage which may be applied to a low-C probe is the same as for a direct probe. Because conventional scopes have blocking capacitors rated at 600 volts, this is the maximum input voltage permissible with a direct probe. Similarly, the components used in commercial low-C probes are not rated for more than about 600 volts. When higher peak-to-peak voltages are to be tested, another type of probe should be used to avoid possible damage to both scope and probe. High-voltage probes are explained later in this chapter.

Why are low-C probes generally designed with a 10-to-1 attenuation factor? This factor is used to tie in with the decade step attenuators on modern scopes. Recall that once a scope has been calibrated with a known peak-to-peak voltage, recalibration is not required when the step attenuator is turned to another position, the decimal point in the calibration factor is merely shifted to the left or right, as the case may be. If the scope is calibrated using a direct probe, it is likewise not necessary to recalibrate if a 10-to-1 low-C probe is to be utilized next. The decimal point in the calibration factor is shifted one place to the right.

## DEMODULATOR PROBES

Technicians commonly make tests in circuits operating at 20 mc, 40 mc, or an even higher frequency even though service

scopes have a top frequency limit of 1 or 2 mc, or occasionally 4 or 5 mc. In order to display waveforms in high-frequency circuits, a demodulator probe is used. The demodulator probe (Fig. 2-4) is a special form of detector probe. It operates on the same principle as a detector in a TV receiver. The rectifier and its associated circuitry recover the modulation envelope

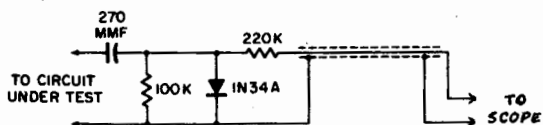

Fig. 2-4. Typical demodulator probe configuration.

from the high-frequency carrier. This modulation envelope contains video frequencies to which a scope can respond. The response of an ordinary demodulator probe is not as good as that of a video detector in a TV receiver. This is because a probe must have a fairly high input impedance to avoid undue circuit loading. A demodulator-probe circuit therefore is like that in Fig. 2-4, instead of like a video-detector circuit. If a demodulator probe were constructed with the circuit principles of a video detector, it would have a very good frequency response. However, the input impedance would be very low, and most IF circuits would be "killed" when the probe is applied to the circuit.

While it is possible to devise wide-band demodulator probes which do not distort horizontal sync pulses, these probes require a cathode-follower tube as an electronic impedance trans-

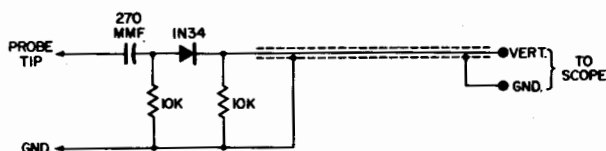

Fig. 2-5. A compromise type of demodulator probe.

former. This makes a wide-band probe somewhat complicated and expensive. Therefore such probes are usually not used outside of laboratories. In service work, the probes are simple and comparatively inexpensive. These provide usable information even though video signals are substantially distorted.

A compromise between circuit loading and waveform distortion is sometimes made by the use of a demodulator probe such as shown in Fig. 2-5. This configuration imposes somewhat greater circuit loading than the probe in Fig. 2-4, but horizontal sync pulses are not distorted so greatly. The technician

must not expect, however, to obtain perfect reproduction of video signals with a simple demodulator probe.

A demodulator probe is sometimes called a *traveling detector*, because it can be used to trace a signal stage-by-stage through an IF-amplifier section. The probe is essentially an indicating device, rather than a measuring device. It would be an error to attempt to measure IF stage gain with a demodulator probe. Circuit loading and detuning often change the stage response greatly, so that amplitude comparisons can be very misleading.

The maximum input voltage which can be applied to a demodulator probe is limited chiefly by the rating of the crystal diode. No more than 50 volts peak-to-peak should be applied as a general rule. This is not a severe limitation because de-

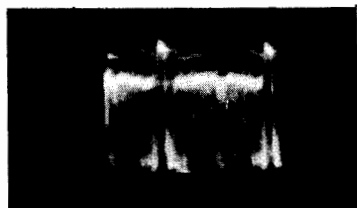

(A) Normal wave, using low-C probe.

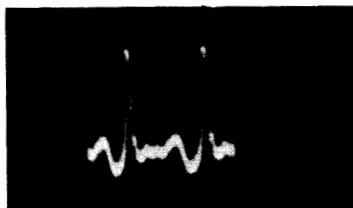

(B) Distorted wave, using demodulator probe.

Fig. 2-6. Do NOT use a demodulator probe in video-amplifier circuits.

modulator probes are used customarily in low-level circuit testing, in which the signal voltage is seldom greater than 5 volts. However, should an IF stage break into oscillation, it is possible for the oscillating voltage to exceed the probe rating and damage the crystal diode in the probe. Caution is therefore advisable.

Again do not make the mistake of using a demodulator probe when a low-C probe should be used. Fig. 2-6A shows a normal waveform in a video amplifier, obtained with a low-C probe. Shown in Fig. 2-6B is the seriously distorted waveform displayed when a demodulator probe is erroneously used. Here are the rules:

1. When the signal frequency falls within the response range of the scope, always use a low-C probe.
2. When the signal frequency is higher than the response range of the scope, always use a demodulator probe.

Beginners are sometimes troubled by the observation that a distorted waveform can *sometimes* be seen when a low-C probe is applied at an IF-amplifier grid or plate. In theory as



applied here, nothing should be seen because the IF frequency is much higher than the response range of the scope. What actually happens is that the IF amplifier is being overdriven by the IF signal. As a result, the tube is driven into grid current. The amplifier tube operates as a partial detector under this abnormal condition of operation.

### RESISTIVE ISOLATING PROBE

A resistive isolating probe is a simple device, consisting merely of a resistor connected in series with the coaxial cable to the scope (Fig. 2-7). This probe is used only in sweep-alignment procedures. It is basically a low-pass filter, consisting of a series resistance feeding into a shunt capacitance (cable capacitance). The probe is a simple integrating circuit.

This probe sharpens the marker indications on a response curve, and helps to remove noise interference when making low-level sweep tests. The probe must have a suitable time

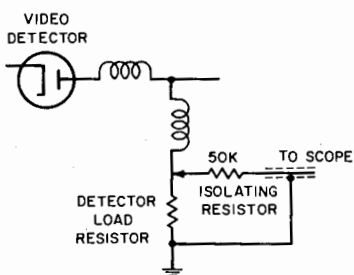

Fig. 2-7. A resistive isolating probe.

constant for satisfactory operation. When the time constant is too long, the response curve is distorted and the marker position (if the marker is on the steep side of a curve) is displaced. On the other extreme, broad markers result when the time constant is too short. In general, a 50-K resistor with a conventional coaxial cable gives a good response in sweep-alignment work.

Beginners sometimes suppose that a resistive isolating probe could be used in place of a low-capacitance probe in testing sync circuits, video-amplifier circuits, etc. However, this is a misconception. The low-pass filter action of the resistive isolating probe weakens or wipes out the high frequencies in such waveforms, imposes phase shifts, and greatly distorts the sync or video waveforms. This probe is also unsuitable for IF-amplifier tests. If applied to IF circuits, nothing is displayed on the scope screen, because the IF signal is "killed" by the probe before it gets to the scope.

## HIGH-VOLTAGE CAPACITANCE-DIVIDER PROBE

High peak-to-peak voltages occur in the horizontal-sweep section of a TV receiver. These voltages will arc-through a low-C probe, damaging both probe and scope. A special probe therefore is required to test these high AC voltages. A typical circuit is shown in Fig. 2-8. This is a capacitance-divider arrangement. When two capacitors are connected in series, an applied AC voltage drops across the capacitors in inverse pro-

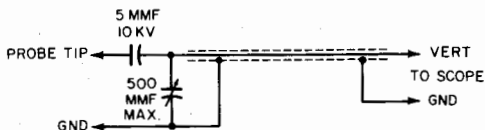

Fig. 2-8. Configuration of a typical high-voltage capacitance-divider probe.

portion to their capacitance values. Thus, if one capacitor has 99 times the capacitance of the other, 0.01 of the applied voltage is dropped across the larger capacitor. In turn, the smaller capacitor requires a high voltage rating.

The attenuation factor of the probe is 100-to-1, and is set by trimmer capacitor. This is a maintenance adjustment. A 100-to-1 factor is used to tie the probe attenuation in with the decade step attenuator of the scope. The probe attenuates horizontal sweep-circuit signals to 0.01 of their source value, thus protecting the scope against damage. If the scope has been calibrated with a direct probe, it is not necessary to recalibrate



(A) Correct waveform, obtained with low-C probe.

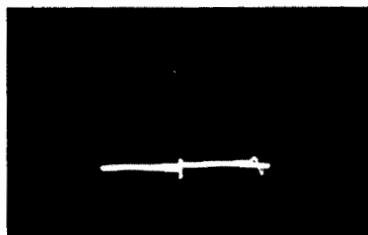

(B) Distorted waveform displayed by high-voltage capacitance-divider probe.

Fig. 2-9. Distortion of 60-cycle wave by high-voltage capacitance-divider probe.

when a high-voltage probe is to be used. The decimal point in the calibration factor is shifted two places to the right.

The high-voltage probe is useful in any horizontal-frequency circuit test. However, it attenuates the usual sync-circuit and horizontal-oscillator voltages too much for convenient observation. Its use is therefore generally restricted to the horizontal-

sweep circuit. Beginners sometimes erroneously use a high-voltage capacitance-divider probe in 60-cycle vertical circuits, such as the vertical-sweep circuit. Vertical-frequency waveforms are distorted by the probe, as shown in Fig. 2-9.

The reason for this distortion is seen from Fig. 2-10. The probe does not stand alone, but works into the vertical-input impedance ( $R_{IN}$  and  $C_{IN}$ ) of the scope. The shunt resistance can be neglected at horizontal frequencies, because it is very high compared with the low reactance of the input capacitance. But, at vertical frequencies, the shunt resistance has a value in the same order as the reactance of the input capacitance. The probe thus acts as a differentiator at vertical frequencies, and vertical-frequency waveforms are badly distorted.

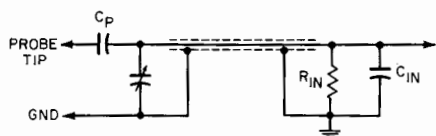

(A) Configuration when connected to vertical input of the scope.

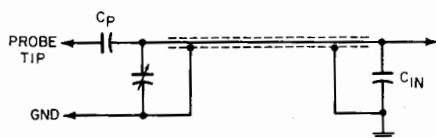

(B) Equivalent circuit at high frequencies.

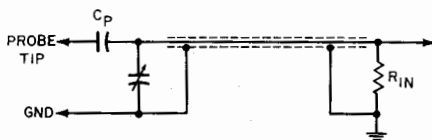

(C) Equivalent circuit at low frequencies.

**Fig. 2-10. High-voltage capacitance-divider probe, and its load circuit.**

When a low-C probe or a high-voltage capacitance-divider probe is used, the waveform aspect is the same as with a direct probe. In most scopes, the beam is deflected when a positive voltage is applied to the vertical input terminal, and vice versa. When a demodulator probe is used, the waveform aspect is determined by the polarity of the crystal diode in the probe. If the diode is reversed, a positive-going sync display will be changed to a negative-going display, as shown in Fig. 2-11.

A few scopes have a polarity-reversing switch, making it possible for the user to invert the pattern. If a negative-going pulse is displayed when a demodulator probe is used, and the operator prefers to invert the display, it is then necessary only

to turn the polarity-reversing switch. Its chief use is in sweep-alignment displays (Fig. 2-12). Some technicians prefer to work with positive-going curves, and a polarity-reversing switch makes the curve aspect independent of detector polarity.

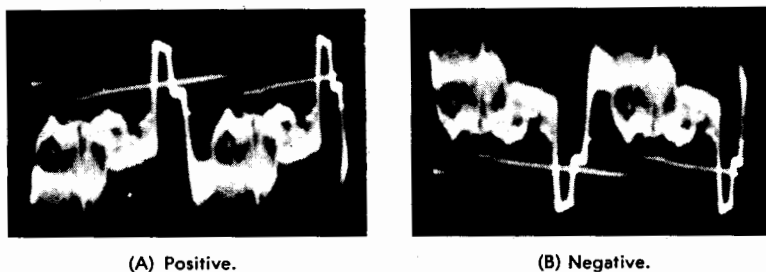

Fig. 2-11. Positive- and negative-going video signals.

### STRAY FIELDS

Exposed binding-post connections—even though a shielded input cable is used to the scope, can be a source of hum or horizontal-pulse pickup when a low-capacitance or demodulator probe is used. The reason for this is that the vertical-input terminal becomes a high-impedance point regardless of the

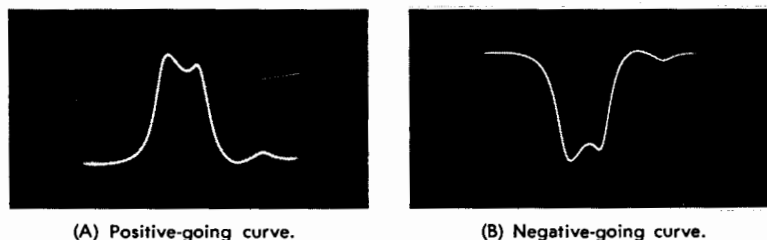

Fig. 2-12. Sweep-alignment curves.

circuit impedance under test. Coaxial connectors therefore are preferred to binding posts. A coax connector provides a completely shielded connection to the vertical channel, which is immune to stray fields.

Beginners are sometimes confused by the stray-field pattern which appears when a direct or low-capacitance probe (or open test leads) are left unconnected on the bench (Fig. 2-13). The stray-field pattern disappears if the probe or leads are connected across a resistor, capacitor, or inductor. Appearance of the stray-field pattern on open circuit is due to the high input impedance and high sensitivity of the scope. Stray fields are a source of very high impedance voltages. When the input impedance to the scope is reduced by connecting the input leads

or probe across a component, stray fields induce a negligible voltage into the leads.

If a low-C probe is connected to a very high impedance circuit, however, and stray fields are fairly strong, the probe tip will sometimes pick up enough stray-field interference to be troublesome. This situation is infrequent. But when it does occur, the stray-field interference can be minimized by remov-



Fig. 2-13. Stray-field pattern, displayed when test leads of scope are left open.

ing the alligator clip from the end of the probe, so that a minimum pick-up surface is exposed. A clip can be used without difficulty in the majority of tests. This is convenient because the probe does not have to be held in contact with the circuit point under test.

Most stray-fields problems are external to the scope itself, but sometimes distortion of waveforms results from internal difficulties. An example is false deflection of the baseline at the left-hand end when the scope is operated at high gain. This results from crosstalk between the blanking and the vertical step-attenuator circuits in most cases. Scopes susceptible to this type of distortion sometimes operate normally when the blanking function is not used. The difficulty can be corrected by enclosing the vertical step attenuator in a grounded shield can.

Baseline distortion may be observed in some cases even when the blanking function is not used. This results from crosstalk between the horizontal-deflection and vertical step-attenuator circuits. The only remedy in this situation is to enclose the step attenuator components in a shield box, as mentioned.

Sometimes an unstable vertical amplifier in a scope will simulate stray-field interference. For example, if the scope does not have input cathode followers, parasitic oscillation may occur in the pattern when testing across a coil with the scope operating at high gain. Most service scopes (but not all) have input cathode followers. Those service scopes without cathode followers may need to be operated with caution when testing resonant circuits which can form a TPTG oscillator in combination with the peaking coils in the first vertical-amplifier stage. This applies principally in signal-tracing sound-IF circuits, which resonate at 4.5 mc.

## WIDE-BAND VERSUS NARROW-BAND RESPONSE

Vertical amplifiers may provide a choice of narrow-band versus wide-band response. The scope bandwidth may be 1.5 mc when switched to the narrow-band position, and 4 mc when switched to the wide-band position. Vertical gain is correspondingly higher in narrow-band operation, because it is a basic electrical law that the product of gain times bandwidth

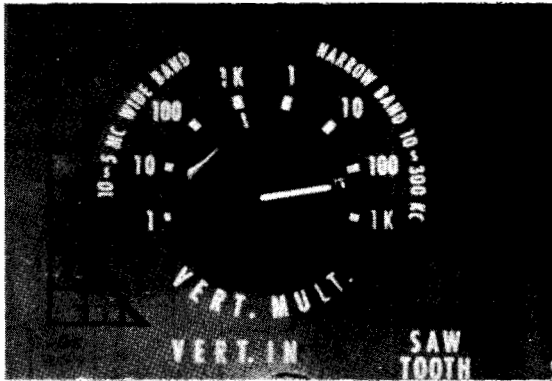

Fig. 2-14. A dual-bandwidth step attenuator.

is a constant for any amplifier. The bandwidth is reduced (and gain increased) by switching higher values of plate-load impedance into the vertical-amplifier circuit. The bandwidth switch is commonly combined with the vertical step attenuator, as seen in Fig. 2-14.

When a demodulator probe is in use, the narrow-band function of a dual-bandwidth scope is most useful. Because of the limited bandwidth of a demodulator probe, no advantage is obtained by wide-band scope operation. However, the increased sensitivity of the vertical amplifier in narrow-band operation is often useful in testing low-level IF circuits.

When a low-C probe is used, the wide-band function of a dual-bandwidth scope is generally preferred. Waveform distortion is minimized. The lower gain imposed by wide-band operation is no handicap because most circuits tested with a low-C probe have ample signal voltage to give full-screen deflection. The same observations apply to the application of direct and high-voltage, capacitance-divider probes.

Resistive isolating probes are commonly used on the narrow-band function of a dual-bandwidth scope. The limited bandwidth of the probe defeats the use of the wide-band function. A compensated step attenuator is not required for use with a resistive isolating probe, nor with a demodulator probe.

## INCONSISTENT LOW-C PROBE RESPONSE

Sometimes when a low-C probe is adjusted for proper response on one setting of the step attenuator, its response is poor on another setting. This generally results from improper adjustment of the compensating trimmers in the step attenuator. (Refer to Fig. 1-20.) In Case C2 or C3, or both, are misadjusted, probe response will be inconsistent on different attenuator steps. Both incorrect attenuation factor and waveform distortion can result.

To check the adjustments of the compensating trimmers in a step attenuator, it is most convenient to use a square-wave signal with an approximate 15-kc frequency. The trimmers are set so that good square-wave reproduction is obtained on each step.

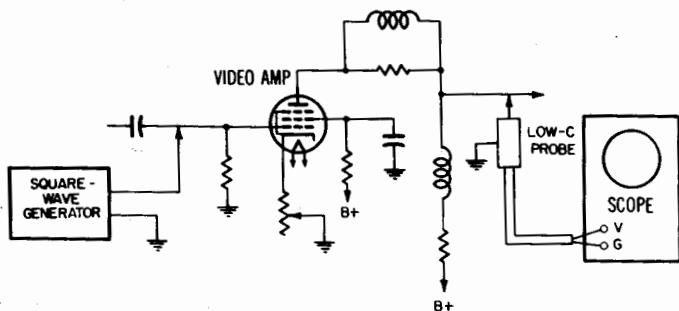

Fig. 2-15. Video amplifier serves as utility wide-band amplifier.

Some square-wave generators have weak outputs, and ample vertical deflection can be obtained only on the X1 position of the step attenuator. In that case, an amplifier must be used between the generator and the low-C probe. A video amplifier in a TV receiver is well suited to this application. Use the test setup shown in Fig. 2-15. An audio amplifier is unsuitable for this purpose because its limited bandwidth will distort a 15-kc square wave severely, unless an unusually good hi-fi amplifier is available.

### Basis of Bandwidth Requirement

Audio amplifiers step up voice and musical frequencies. The range of these frequencies can be simply demonstrated by connecting a speaker to the vertical-input terminals of a scope. The waveform of any sound entering the speaker will be seen on the scope screen. If the speaker output transformer is used, connect the primary terminals to the scope input terminals. Much weaker sounds are then reproduced. Analysis of various

speech and musical tones will show that a top frequency of about 10 kc and a lower limit of about 20 cycles is necessary for full reproduction of sound. This is the bandwidth requirement of an audio amplifier.

Video-IF amplifiers step up modulated-IF signals. The basis of the bandwidth requirement is illustrated in Fig. 2-16. A modulated sine wave has *sideband frequencies*. These sideband

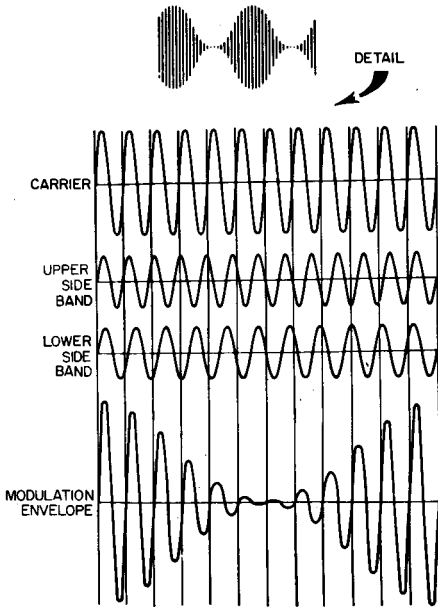

Fig. 2-16. Build-up of a modulated sine wave.

frequencies can be separated individually from the modulated wave by narrow bandpass filters, such as those in amateur radio gear. The "spread" of the sideband frequencies determines the bandwidth requirement of an IF amplifier. For example, consider a 40-mc carrier wave modulated by a 4-mc video signal. The modulated wave consists of the 40-mc carrier, a 44-mc sideband, and a 36-mc sideband. A form of single-sideband transmission and reception is used in TV transmission, so that the IF amplifier need have only a bandwidth of 4-mc, instead of 8 mc. For the example cited, the IF amplifier would pass the 40-mc carrier and the 44-mc sideband.

### GROUND LEAD OF SCOPE PROBE

Beginners sometimes overlook the necessity for a suitable ground return when making oscilloscope tests. Consider the



simplest situation (Fig. 2-17) in which an open test lead is connected from the vertical-input terminal of the scope to the circuit under test. Excessive hum voltage appears in the pattern, as shown, as no ground lead is connected between the scope case and the chassis of the receiver under test. The hum voltage appears because the ground-return path is forced to route itself through the power supplies of the receiver and

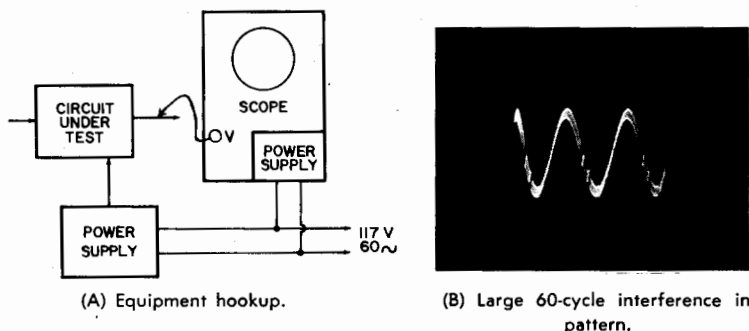

Fig. 2-17. Effect of ground-return lead to scope omitted.

scope via the 117-volt line. The hum interference disappears when a ground lead is connected from the scope case to the receiver chassis.

The need for a complete circuit is plainly evident in the case of DC flow, as in Fig. 2-18. If one of the leads is omitted, the lamp does not light. However, capacitance can complete a ground-return circuit in an AC configuration (Fig. 2-19). The reactance of capacitor C at 60 cycles permits AC to flow through the neon bulb. The bulb glows, although there is not a complete metallic path around the circuit. (Note that one side of

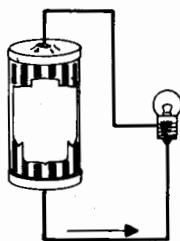

Fig. 2-18. If one of the leads is omitted, the lamp does not light.

the power line is always grounded, as a protection against lightning.) The higher the capacitance of C, the brighter the lamp glows.

Both the receiver and the scope depicted in Fig. 2-20 have power-supply transformers. There is stray capacitance between primary and secondary of each transformer. Although there is

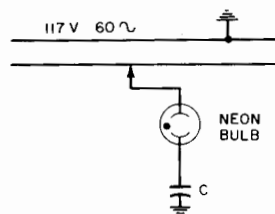

Fig. 2-19. C provides a return circuit.

no ground lead connecting the receiver chassis and the scope case, a high-impedance "connection" nevertheless exists between them, due to stray capacitances C1 and C2. There is a small capacitive transfer of 60-cycle current from primary to secondary via C1 and C2. It is so small that it is generally regarded as being of no importance. Nevertheless, if a ground-return lead from the scope to the receiver chassis is mistakenly omitted, forcing a ground-return path through C1 and C2, the small 60-cycle voltage drop across each of stray capacitances C1 and C2 appears in the pattern if a ground-return lead is not used.

In the case of a *demodulator* probe, it is quite essential to use the short ground lead which is connected to the probe housing. Technicians sometimes suppose that if an open ground lead is run from the scope to the receiver chassis, there is then no need to bother with the short high-frequency ground lead of the probe. This is a serious error for the following reason. Unless the high-frequency ground lead is kept quite short, its series inductance and stray capacitance will act as a filter and seriously disturb the high-frequency signal. At 40 mc, for example, the signal may be killed completely. If a long ground lead permits some IF signal to pass, the waveform is likely to be highly distorted.

The need for using the short ground lead provided with a *low-capacitance* probe is less important. But, when testing

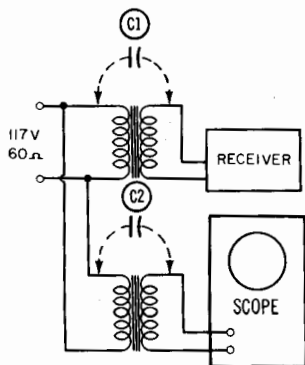

Fig. 2-20. Stray capacitances C1 and C2 form a high-impedance "connection" between the receiver chassis and scope case.

video waveforms (which have frequency components up to 4 mc), waveform distortion can occur unless a reasonably short ground-return lead to the probe is used.

## CHAPTER 3

# Signal Tracing in RF, IF, and Video Amplifiers

Signal tracing is the procedure by which the progress of an applied signal voltage is checked, stage by stage, through the signal channels of a television receiver. The signal channels comprise an RF amplifier, mixer, video-IF amplifier, video amplifier, sound-IF amplifier, and audio amplifier.

### TROUBLESHOOTING RF AMPLIFIER

When the symptom is "no picture and no sound," signal tracing starts logically at the front-end—after tubes have been checked, of course. A typical front-end configuration is shown in Fig. 3-1. The *test point* (often called the *looker point*) is a convenient terminal from which to make a preliminary signal-tracing test. A low-capacitance probe and scope are connected to it, and the front-end input terminals energized from a TV antenna or from a pattern or signal generator. If the scope has good sensitivity, about an inch of vertical deflection will normally be obtained from a fairly strong input signal. When a pattern generator is used, the video waveform in Fig. 3-2 will normally be observed.

If the scope sensitivity is low, a direct probe can be applied to the looker point—although the increased circuit loading will add to the waveform distortion. Even with a low-C probe, the reproduced video waveform has appreciable distortion because the looker point is a tap on the mixer grid-leak. Thus, between the mixer grid and the probe there is series resistance, which acts as a low-pass filter. The horizontal-sync pulses are attenuated considerably, and the high-frequency components of video information are lost. Nevertheless, the significant consideration is the *presence or absence* of the signal. If absent, the front-end components must be checked. DC voltages can be measured with a VOM or VTVM, and resistors with an ohmmeter. Capacitors must be removed from the circuit and checked on a tester (or by substitution). When components are

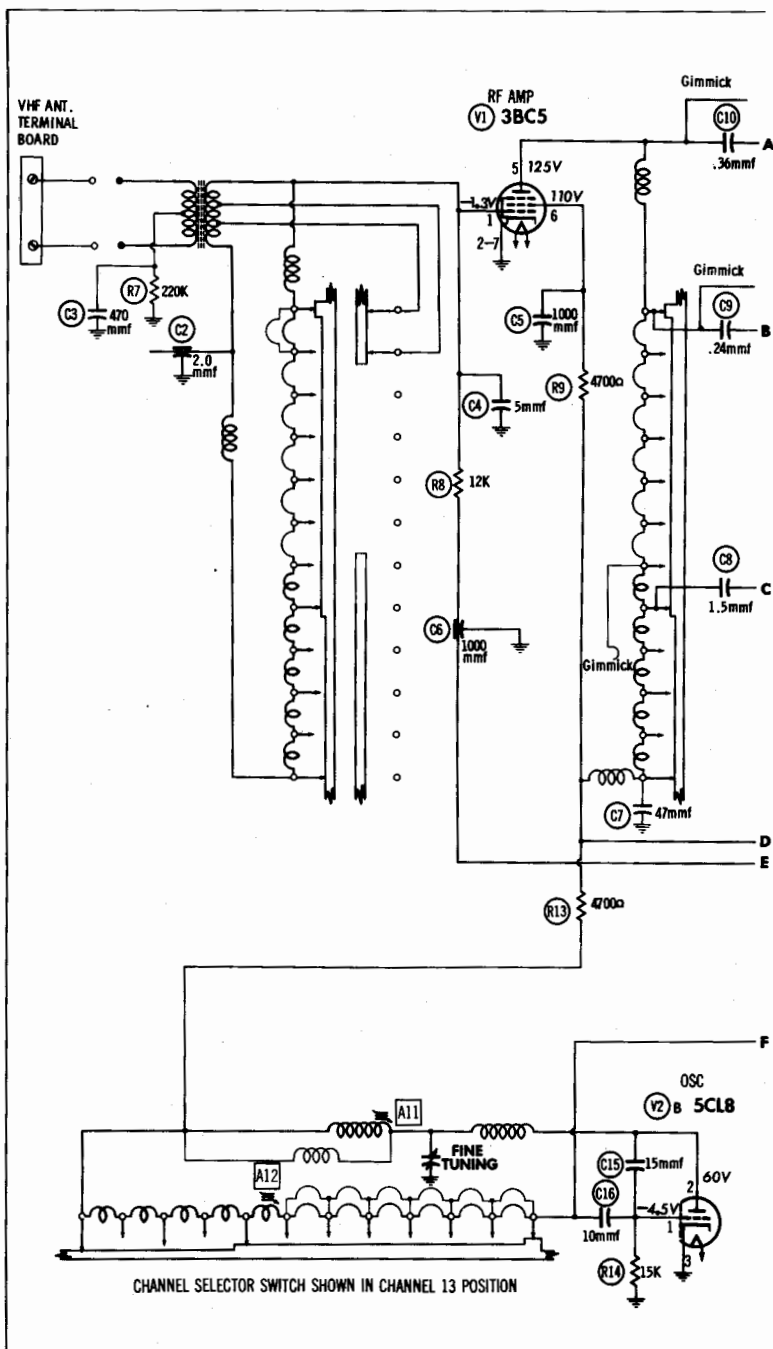
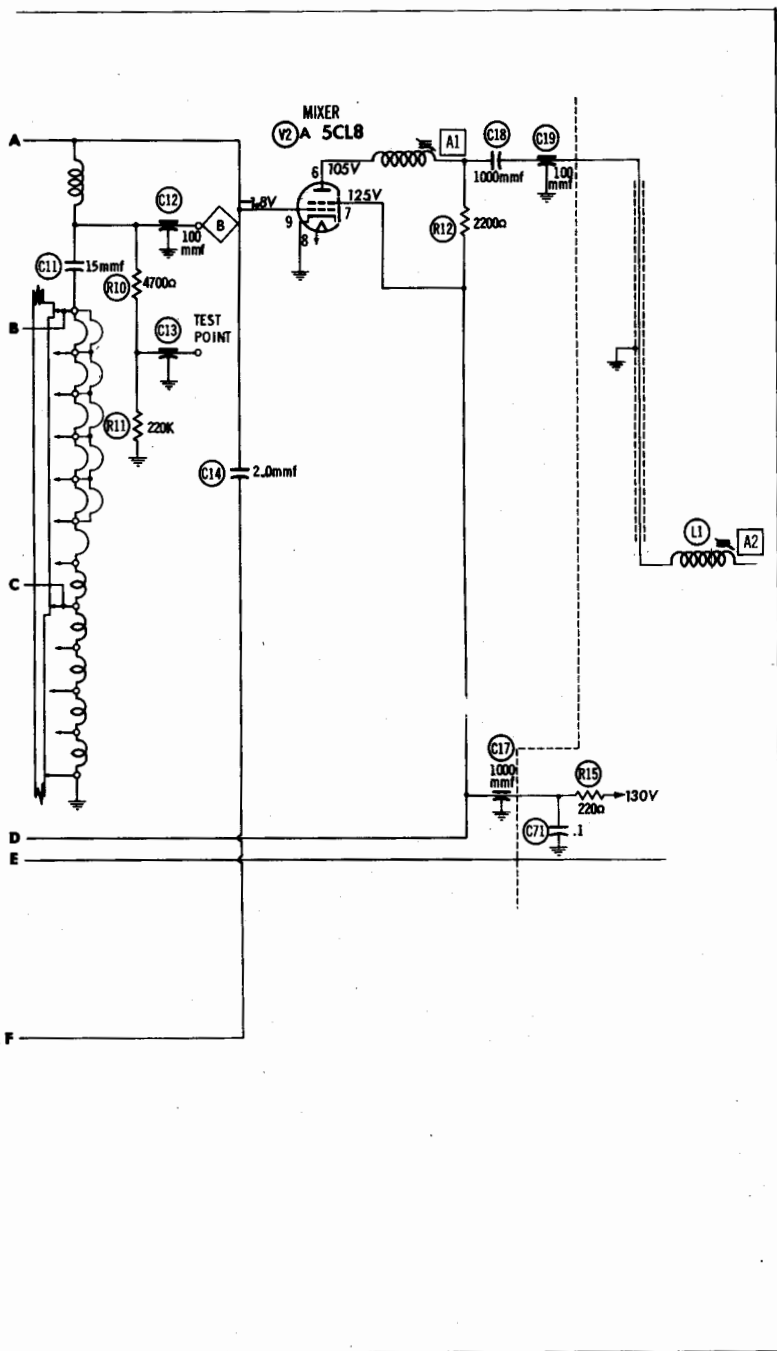

Fig. 3-1. Typical



front-end configuration.

inconveniently "buried" in a front-end, many technicians prefer to send it to a specialty shop for repair.

There is a reason for using a low-C or direct probe at the looker point, instead of a demodulator probe. The mixer is a heterodyne configuration in which the grid circuit operates basically as a rectifier, and not as an amplifier. (There is a small gain through the mixer stage, but this is not its primary function.) The grid normally operates at zero bias (or contact potential). Should a DC bias voltage be fed to the grid, the tube would be biased to the midpoint of its characteristic and operate as an amplifier instead of detector. No IF signal would appear at the plate and, for all practical purposes, the mixer would be dead.

A substantial negative bias will appear on the mixer grid during normal operation. It is generated by grid-current flow during positive peaks of the oscillator signal, which is injected into the mixer grid circuit. This signal-developed bias provides a good check of oscillator operation. If a VOM or VTVM measures zero volts or only the contact potential (about  $-0.5$  volt), the oscillator stage is dead.

When no signal is found during a scope check at the looker point, do not forget to measure the AGC voltage to the RF amplifier. AGC trouble can bias off (cut off) the RF-amplifier tube, and thereby give a false appearance of front-end trouble. The AGC voltage should measure nearly zero volts with no signal input to the front end. With an applied signal, several volts of negative bias will be measured when the signal level is turned up.

If a TV station signal is used, a changing video waveform is normally displayed at the looker point. The signal has the basic appearance shown in Fig. 3-2. If an AM signal generator is used to drive the front end, a sine-wave signal is normally observed at the looker point (Fig. 3-3). The waveform may or may not appear distorted, depending upon the signal generator being used. Some AM generators have a good sine-wave modulation, while others have a highly distorted waveform. Distorted modulation is not of concern; only the *presence* of a signal is checked.

The detector action of a mixer tube is indicated in Fig. 3-4. Partial rectification is illustrated. The modulated RF input signal has an average value of zero, because the positive and negative half cycles have equal excursions. The output signal, however, does not have an average value of zero. It has a DC component on which the modulating frequency component is superimposed. The modulating frequency is comparatively low, and falls within the response range of the scope. Hence, the modulating frequency waveform is seen on the scope screen.

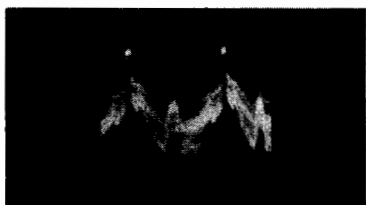

Fig. 3-2. Video waveform present at the looker point.

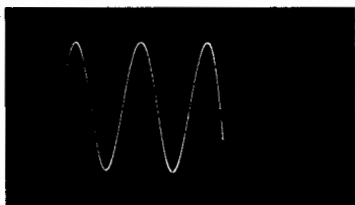
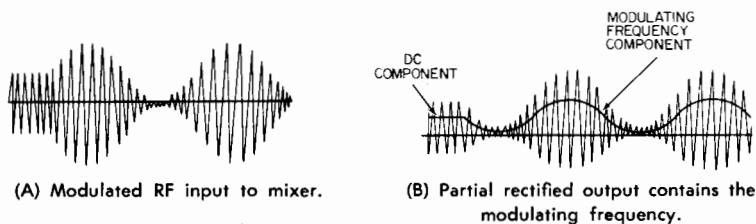

Fig. 3-3. AM generator displays a sine-wave signal.

### SIGNAL TRACING IN THE IF SECTION

A demodulator probe is used to signal-trace the video-IF section. Fig. 3-5 shows a simplified video-IF circuit, with successive test points lettered. The lowest signal level occurs at point A, and the highest at point H. The normal signal level at point E will be greater than the normal level at point D, due to the stage gain. However, when making demodulator probe tests, the reverse may *seem* to be the fact. Input capacitance of the probe causes circuit detuning.



(A) Modulated RF input to mixer.

(B) Partial rectified output contains the modulating frequency.

Fig. 3-4. Detection process in mixer tube.

IF amplifiers are staggered-tuned. In case L3 is tuned to a lower frequency than L2, application of the probe at point E temporarily makes its resonant frequency still lower. The impedance of the L3 plate-load circuit becomes abnormally low. The stage may appear to have a loss instead of a gain. Hence, do not consider apparent gain indications as meaningful, and look merely for the presence of a signal. A typical pattern is shown in Fig. 3-6. The scope is deflected at a 30-cycle rate, because the pattern is distorted (due to limited probe bandwidth), and the vertical sync pulse is the most prominent element in the pattern.

In the example cited, wherein L2 is tuned to a higher frequency than L3 (Fig. 3-5), applying the probe at point D may cause the IF stage to break into oscillation. This occurs when the probe's input capacitance lowers the resonant frequency of L2 to about the same value as L3. The stage then operates as a tuned-plate tuned-grid oscillator. No pattern appears on



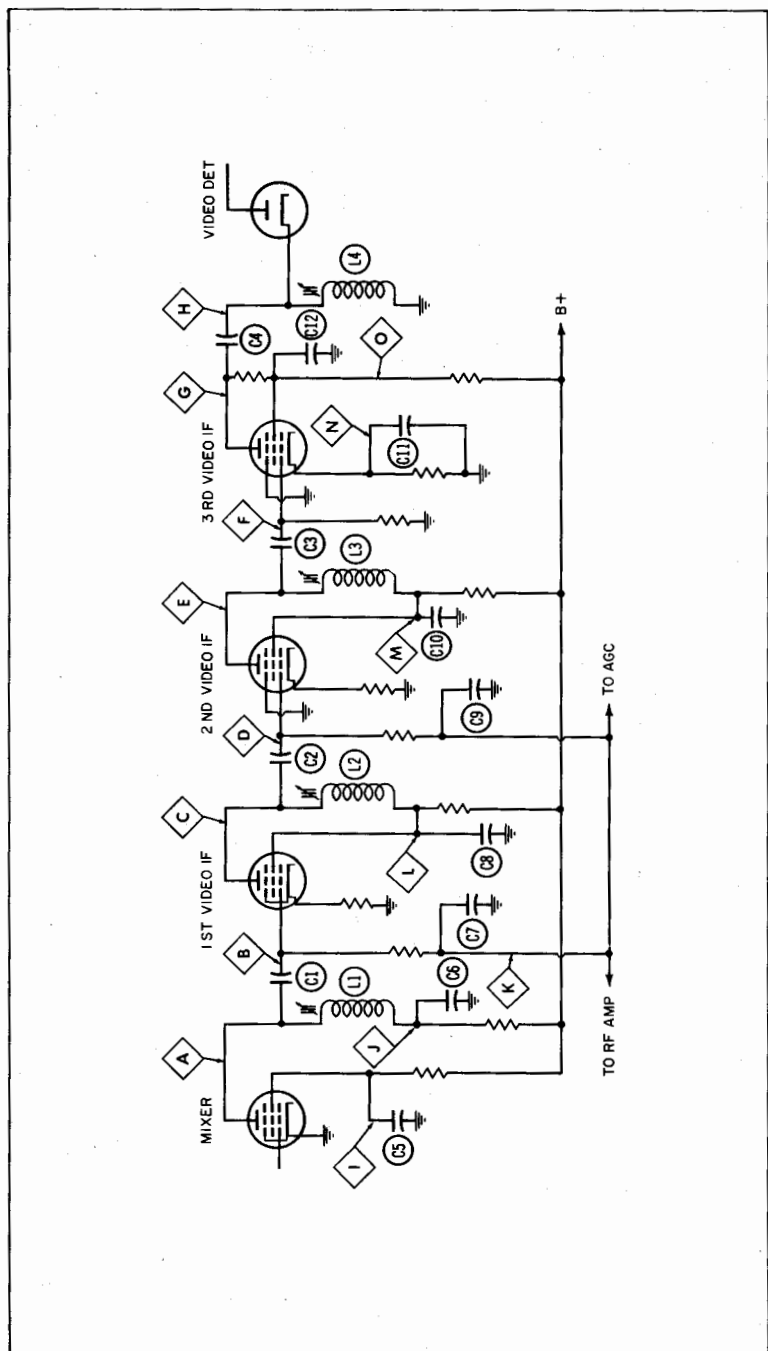
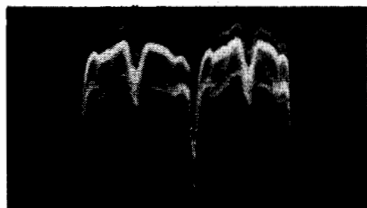

Fig. 3-5. Diagram of a three-stage video-IF amplifier system.

the scope screen, because the stage is blocked by the high signal-developed bias resulting from oscillation. Thus, the stage may *seem* to be dead when tested at point D, but the false conclusion is avoided by observing that a signal is found at point E.

If a signal is found at point C, but not at point D, this indicates that coupling capacitor C2 is open. Little or no signal is normally found at decoupling points, such as I, J, K, etc. Do not be misled by the presence of a *small* signal at decoupling

Fig. 3-6. Typical pattern obtained in an IF signal-tracing test.



points. It is difficult to get a perfect AC ground at 40 mc, because of the series inductance of connecting leads. Thus, unless the leads of the decoupling capacitor are very short, bypass action is somewhat incomplete. When a stage does not check out satisfactorily in the signal-tracing test, individual components in the stage are tested next. DC voltages and resistances are measured, and compared with values specified in the receiver service data. Capacitors are tested on a capacitor checker, or by substitution.

### Poor Picture Quality

Trouble in the IF amplifier can cause a poor picture-quality symptom, as illustrated in Fig. 3-7. If a laboratory-type (wide-band) demodulator probe is available, the defective stage can be located directly by a signal-tracing procedure. The video signal is inspected for distortion as the probe is moved progressively through the IF-amplifier section. If a service-type demodulator probe is used, the video signal is so severely dis-

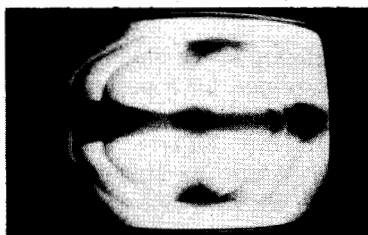

Fig. 3-7. A poor picture-quality symptom.

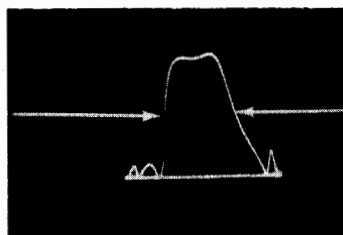

Fig. 3-8. Bandwidth is measured between the half-voltage peak points.

torted that the needed indication is masked. Therefore an indirect troubleshooting method must be used.

A sweep generator is used, instead of a pattern or signal generator. For details of application, the reader is referred to *101 Ways to Use Your Sweep Generator*. Good picture quality depends upon adequate bandwidth and a reasonably flat-topped frequency response. Fig. 3-8 shows how bandwidth is measured between the 6-db (half-voltage) points. A bandwidth of at least 3 mc is required for acceptable picture quality.

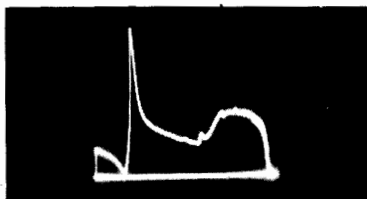

Fig. 3-9. A sharp peak on a response curve causes ringing.

If the top is not reasonably flat, but sharply peaked, as in Fig. 3-9, picture quality is poor even when bandwidth is adequate. A sharp peak causes ringing in the picture (circuit ghosts).

A demodulator probe suitable for signal tracing can be constructed by using the circuit shown in Fig. 3-10. Although the probe is bulky, and requires a bench power supply (preferably

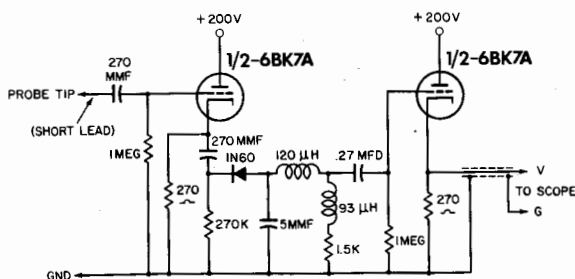

Fig. 3-10. Wide-band demodulator probe.

regulated), it is highly useful for localizing an IF stage causing poor picture quality. The IF signal provided by a pattern generator or TV antenna is checked at the grid and plate of each IF tube. An undistorted video signal (Fig. 3-11) is normally found at each grid and plate terminal. When the stage causing poor picture quality is tested, the scope shows a distorted video signal. Horizontal sync pulses appear higher or lower than the vertical sync pulse, and the pulse shape is distorted. The proportion of sync to video is changed.

When the distorting stage is localized, the DC voltages and resistances in the circuit are measured, capacitors are checked, and the stage alignment is investigated. Alignment of the tuned circuits is usually checked last, because poor picture quality is most likely to be caused by a defective component. There is

Fig. 3-11. Undistorted video signal.



usually only one defective component to be localized. If a screen-bypass capacitor is shorted, however, it sometimes damages the screen resistor also, because of excessive current drain.

#### **Picture Pulling, or Loss of Sync**

When an IF tube is overloaded, the sync pulses are always compressed or clipped, as seen in Fig. 3-12. Overloading is usually caused by the grid or cathode bias being too low. Thus, if C11 or C9 becomes shorted (Fig. 3-5), sync compression can be expected. Of course, it is assumed that IF-amplifier tubes are good. Vertical-sync punching is often observed when bias on an IF tube is too low. The vertical-sync pulse is depressed below the level of the horizontal pulses. Sync punching causes unstable vertical sync, or complete loss of vertical lock.

Fig. 3-12. Sync pulses compressed.



Severe overloading in an IF stage can cause a negative picture, when the grid-leak resistance is comparatively high. When a picture is completely negative, all the tones are reversed. When it is partially negative, the deep grays and blacks are reversed in tone, while medium and light grays are reproduced normally. Negative picture reproduction is caused by modulation reversal, whereby positive modulation is converted to negative modulation. Excessive grid-current flow, with suitable circuit constants, results in this conversion.

### Hum in the IF Signal

There are two types of hum voltage which can enter the video signal. Power-supply hum may be either 60-cycle or 120-cycle frequency, depending on the type of power supply. Heater hum has a 60-cycle frequency. A scope is a sensitive indicator of hum, and shows clearly the presence of hum voltage at levels below the point at which hum bars appear in the picture. When



Fig. 3-13. Hum in the video-IF signal.

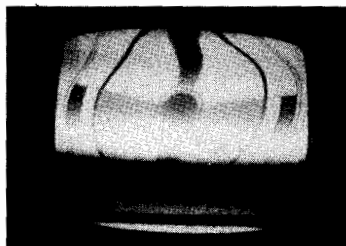

Fig. 3-14. Strong hum bar in picture.

the hum level is high, the video signal appears typically as shown in Fig. 3-13, and the picture contains hum bars as in Fig. 3-14. Sync stability is often affected when the hum level is high.

Basically, 60-cycle hum produces one cycle of sine-wave curvature in the video signal, while 120-cycle hum produces two cycles. The pattern is not always simple. AGC action tends to smooth out the hum, and amplification becomes nonlinear when the hum level is high, distorting the hum waveform. Only heater hum has a sine source waveshape; power-supply hum usually has a distorted sawtooth waveshape.

To trace hum voltage to its source in an IF amplifier, it is usually necessary to clamp the AGC line with a bias box or battery. Doing so eliminates the confusion of AGC reaction, and the video signal will be normal until the stage injecting the heater hum voltage is reached. Thus, heater hum is easily and definitely localized in a signal-tracing test.

Power-supply hum, however, is a generalized source which feeds into all the IF stages. The hum component increases from stage to stage, and has its lowest amplitude at the first IF grid. When power-supply hum is suspected, use a low-C probe with the scope, and check for hum on the B+ supply line. There is always some hum voltage present, but it should not be greater than the value specified in the receiver service data.

If normal reception resumes when the AGC line is clamped, the hum voltage is entering the IF amplifier via the AGC line. The trouble then will be found in the AGC section, and not in

the IF section. Do not confuse hum voltage on the AGC line with 60-cycle variations stemming from sync-section trouble. For example, if a fault in the AFC circuit causes the picture to pull considerably at the top, a loss of phase occurs between grid and plate pulses in a keyed-AGC tube, and a 60-cycle voltage simulating hum appears on the AGC line.

### Low Contrast Versus Stage Gain

Low contrast in the picture (Fig. 3-15) is due to low gain. It is sometimes necessary to localize a low-gain IF stage, to clear up a symptom of low contrast. Localization is uncertain

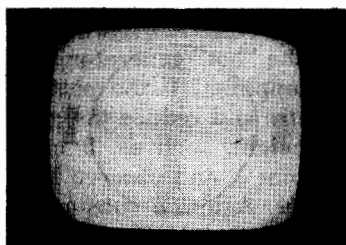

Fig. 3-15. Picture has low contrast.

with a demodulator-probe test, because of the erratic nature of circuit loading imposed by ordinary probes. However, by using the picture detector as the demodulator, and using an IF signal-injection technique, a low-gain stage can be quickly localized.

The test setup illustrated in Fig. 3-16 can be used. Connect a scope and low-capacitance probe to the picture-detector out-

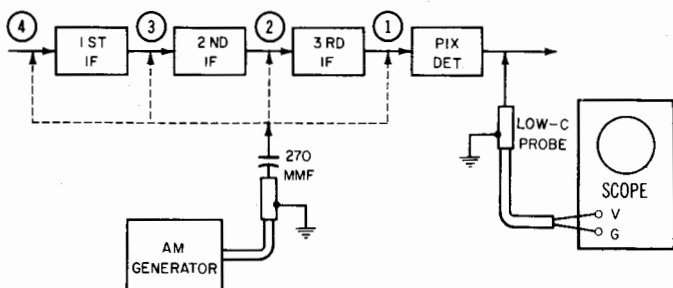

Fig. 3-16. Stage-gain test setup.

put, to serve as an indicator. Use an AM generator as a signal source, and connect a 270-mmf blocking capacitor in series with the "hot" lead, to avoid drain-off of DC bias. Clamp the AGC line with  $-1.5$  or  $-3$  volts DC from a bias box or battery, and apply the generator signal first at point 1 to drive the input of the picture detector. Operate the generator on its modulated-

output function, tune to the mid-frequency of the IF band, and advance the generator output to produce about a half inch of vertical deflection on the scope screen. (This is a sine-wave pattern.)

Next, transfer the "hot" lead from the generator to point 2, the grid of the third IF tube. In case the third IF stage is operating normally, the sine-wave pattern on the scope screen will increase in height considerably. With  $-1.5$  volts bias, a gain of 5 is typical; however, the exact stage gain differs depending upon the tube type and circuitry details. If the third IF stage is faulty, the pattern will increase only a small amount in height, or may even decrease. In such case, check out the components in the third IF stage.

The next test is made by connecting the "hot" generator lead to point 3, the grid of the second IF amplifier. If the pattern is off-screen vertically, go back to point 2 and reduce the generator output for a suitable pattern height, such as .5 inch. Then, transfer the generator lead to point 3, and observe how many times the pattern height increases. Again, a substantial gain should be found. Otherwise, there is a defective component in the second IF stage.

The first IF stage is checked for gain by transferring the generator lead to point 1, the grid of the first IF amplifier. This progressive test procedure will show definitely whether a low-contrast picture symptom is due to IF trouble, and if so, which stage is at fault. Each time the generator lead is moved back one stage, the true gain of the stage is determined, for the particular grid-bias voltage to which the AGC line is clamped.

This procedure gives a true gain figure, because the AM generator has low output impedance (the output cable is terminated usually in either 50 or 75 ohms). When the generator signal is applied to the grid of an IF tube, the low impedance of the source "swamps out" the resonant response of this grid circuit, and the following IF circuitry operates normally.

### **Ground-Circuit Difficulties**

Although ordinary low-impedance demodulator probes are not susceptible to stray-field interference, application problems can arise in low-level circuits due to extended ground loops. In signal-tracing the first-IF stage, e.g., when the signal is checked at point A in Fig. 3-17, a different pattern may be observed if the probe is grounded at point 2, instead of at point 1. The reason is that the separated ground points have appreciable reactance between them at 40 mc. If the probe is grounded at point 2, the voltage difference between points 1 and 2 is added to the grid waveform. Obviously, if the demodulator probe is connected between grounds 1 and 2, the probe input is not

short-circuited. Instead, a waveform is seen on the screen when the scope is operated at high gain. The farther a pair of 40-mc grounds are separated, the greater the ground-circuit interference.

Some IF amplifiers have a common ground point for all components within a given stage. In such case, the possibility of ground-circuit pickup is not present. However, this is not true of all IF strips, as ground points for grid and plate circuits

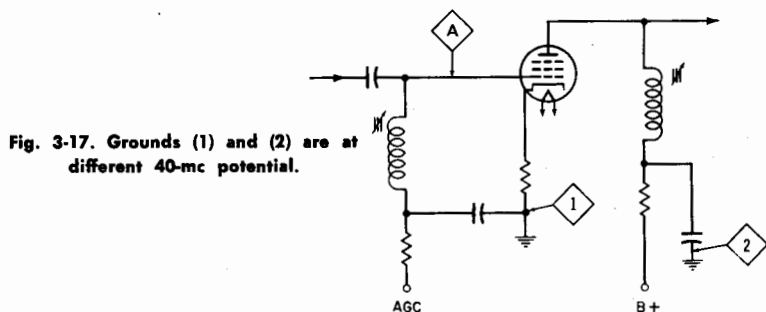

may be separated several inches, in some chassis. The most troublesome ground-circuit interference occurs when the probe is moved from one stage to the next, without transferring the probe ground lead. That is, the signal is being checked in the first IF stage, for example, but the probe ground is connected to the chassis at the output of the second stage. This is very poor practice, because the ground-circuit drop may introduce more signal voltage than is present at the first IF grid.

### SIGNAL TRACING IN THE VIDEO AMPLIFIER

A low-C probe is used when signal-tracing in the video-amplifier section. Fig. 3-18 shows a typical circuit for the video-amplifier section. This is an AC-coupled amplifier. Some video amplifiers are DC coupled, and many utilize only one stage. The coupling capacitors in AC-coupled amplifiers are checked easily in the signal-tracing procedure. Fig. 3-19 shows how a low-C probe is shifted from input to output of a coupling capacitor in this test. Practically the same undistorted video signal is found normally at either end of the capacitor.

If the capacitor is open, or nearly open, the video signal is normal at the input end, but differentiated at the output, as shown in Fig. 3-20. If a good capacitor is bridged across the open unit, the output waveform is restored to normal. Thus, the scope and low-C probe serve as an efficient in-circuit capacitor checker.



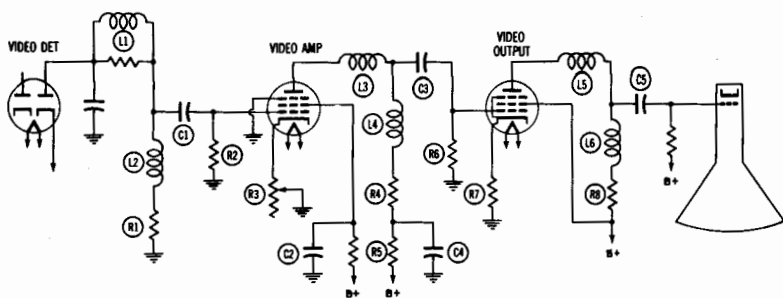

Fig. 3-18. Typical video-amplifier circuit.

In case an integrated video signal is observed, as shown in Fig. 3-20B, decoupling capacitor C4 (Fig. 3-18) would be the suspect. The suspicion is confirmed by checking across C4 with the probe. If video signal is present, the capacitor is open. An open decoupling capacitor causes integration of the video signal because the plate-load resistance is thereby increased to an abnormally high value. In turn, high video frequencies are attenuated and shifted in phase. Phase shifts in the video signal cause picture smear.

In order to see clearly the nature of frequency distortion and phase shift in a video signal, it is helpful to observe a simplified waveform consisting of a hybrid sine and square wave, as seen in Fig. 3-21. This waveform normally consists of a section of sine wave followed by a section of square wave. When differentiated, the flat top becomes curved downward, showing the loss of low frequencies. Also, the sine-wave section is shifted in phase, and leads the normal wave. The flat top becomes curved upward when integrated, showing the loss of high fre-

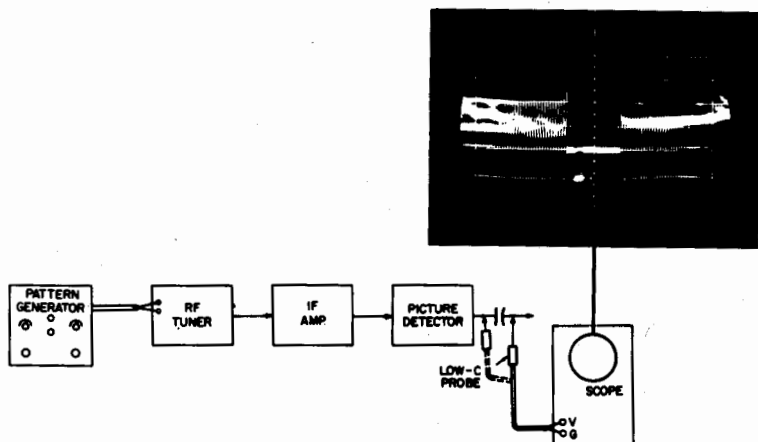

Fig. 3-19. Signal tracing across a coupling capacitor.



(A) Normal video signal.



(B) Integrated signal.

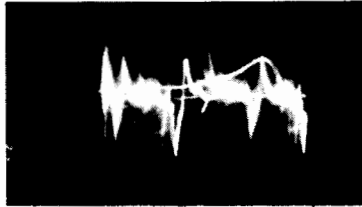

(C) Differentiated signal.

Fig. 3-20. Normal and abnormal video waveforms in Fig. 3-18.

quencies. The sine-wave section is shifted in phase, and lags the normal wave.

### White Compression

When incorrect operating voltages cause a video-amplifier tube to compress or clip the video signal in the white region (Fig. 3-22), the picture appears muddy and filled up. On the other hand, compression or clipping of the sync tips causes impaired sync lock. Although sync clipping can occur in either the video amplifier or the IF amplifier, white compression occurs only in the video amplifier.

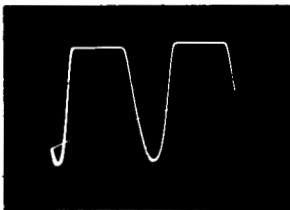

(A) Normal waveform.

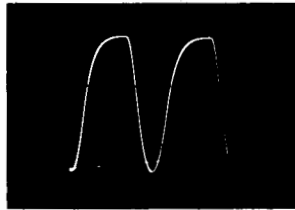

(B) Integrated waveform.

Fig. 3-21. Hybrid sine and square waves.

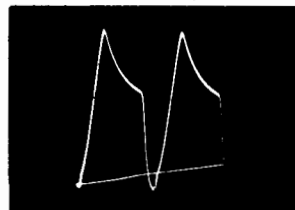

(C) Differentiated waveform.

If white compression is localized to a stage, check the DC voltages at the video-amplifier tube(s). Incorrect grid or cathode bias is the most common cause, although off-value plate and screen voltages are sometimes responsible. A leaky coupling capacitor, or a shorted cathode-bypass capacitor changes the grid and cathode bias voltages, respectively. Off-value plate or screen voltages are usually caused by resistors increasing in value (although a resistor occasionally decreases in value). A leaky screen-bypass capacitor reduces the screen voltage, and a leaky plate-decoupling capacitor reduces the plate voltage. An open screen-bypass capacitor causes a greatly reduced gain figure, and the picture has low contrast.

Gain is checked quickly by comparing vertical deflections at the input and output of the video amplifier. Since normal gain figures vary considerably from one chassis to another, check the receiver service data. Peak-to-peak voltages at the video-amplifier output and input are specified. If the gain is normal, but the peak-to-peak voltages are low, the trouble is in a stage ahead of the video amplifier.

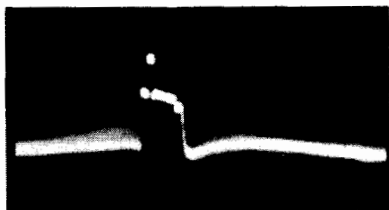
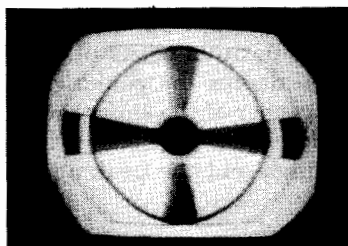

Fig. 3-22. Video signal with white portions compressed.

### Poor Definition

If poor picture definition occurs in the video amplifier, a signal-tracing test with square-wave input will disclose the faulty circuit. The output from a square-wave generator is applied at the video-detector output terminal, and a low-C probe is connected to the video-amplifier output terminal. Poor-definition picture, sweep-frequency response, and 100-kc square-wave symptoms are shown in Fig. 3-23. The attenuated high-frequency response in the sweep-frequency pattern and the rounded corners in the 100-kc square-wave pattern correspond to the "wiped out" vertical wedges in the test pattern.

The symptoms shown in Fig. 3-23 throw suspicion on the load resistors or peaking coils in a branch of the video amplifier. Remember that the video-detector output circuit is also the video-amplifier input circuit. Therefore, if the video-detector load resistor increases in value considerably, the symptoms seen in Fig. 3-23 appear. The square-wave signal-tracing procedure is useful because the distorted response is first found at the defective circuit branch.



(A) Picture.

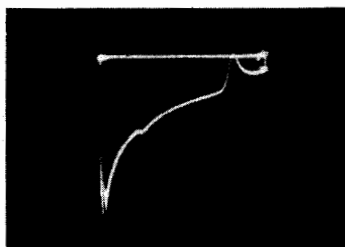

(B) Sweep-frequency response.

**Fig. 3-23. Picture, sweep-frequency, and 100-kc square-wave symptoms.**

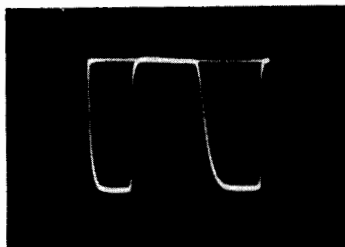

(C) Square-wave response.

A peaking coil is sometimes shunted by a damping resistor, as indicated in Fig. 3-18. If the peaking coil opens, the circuit is still operative through the damping resistor. However, high-frequency distortion is severe, square-wave corner rounding is very evident, and the picture is badly smeared. If a damping resistor opens up, or increases greatly in value, the usual symptom is square-wave overshoot (Fig. 3-24). A small amount of overshoot is not objectionable, and has the effect of sharpening the edges of objects in the picture, particularly when old movie films are being televised. However, excessive overshoot causes an objectionable "outlining" of sharp edges in an image.

When the chassis has a one-stage video amplifier, the tube must be driven to maximum output to obtain normal picture contrast. Unless adequate screen and plate voltages are supplied to the tube, full contrast may require driving the grid into grid-current flow on positive peaks. In that case, any over-

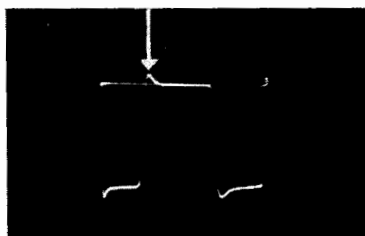

**Fig. 3-24. Square wave with overshoot.**

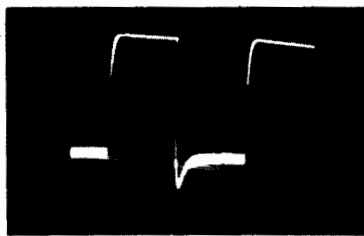

**Fig. 3-25. Square wave that has an unsymmetrical overshoot.**

shoot arising in the grid-circuit branch appears as an unsymmetrical overshoot (Fig. 3-25). On positive peaks of drive signal, the low grid-circuit impedance damps the peaking-coil response excessively, and the leading corner of the square wave is rounded. On the other hand, during negative peaks of drive signal, the grid-circuit impedance is high and the peaking-coil response is undamped by the tube.

### **Ringing and Circuit Ghosts**

In case the plate-load resistor of a video-amplifier tube decreases in value considerably, the high-frequency response rises excessively. In turn, a square wave of pulse shows both overshoot and ringing, as in Fig. 3-26. Here, the ringing is more prominent on the trailing edge, due to grid-current flow on the leading edge. Ringing produces "repeats" or circuit ghosts in the picture.



**Fig. 3-26.** Differentiation, ringing, and overshoot in a reproduced square wave.

Excessive high-frequency response implies subnormal low-frequency response. This results in more or less tilt in the top of the square wave. Tilt also can be caused by a nearly open coupling capacitor. The picture symptom is lack of a solid tone across an image, or smear. Severe tilt is apparent in Fig. 3-26, along with the overshoot and ringing.

A valid check for ringing cannot be made unless the square-wave generator has a sufficiently fast rise time. The generator rise time should be at least as fast as the video amplifier. According to a rough rule of thumb, the rise time of an amplifier is given by one-third of the period corresponding to the frequency 3 db down at the high end. In other words, if a video amplifier has a 4-mc bandwidth, the corresponding period is 0.25 microsecond, and the rise time will be about 0.08 microsecond. Hence, the square-wave generator should have a rise time of 0.08 microsecond, or less, for a useful ringing test.

## CHAPTER 4

# Signal Tracing in The Sync Section

The sync separator is a branch off the signal channel. Its purpose is to clip the sync tips from the composite video signal. The separated sync signal is then used to synchronize the horizontal and vertical oscillators.

### THE BUS CIRCUIT

A typical sync-separator circuit used in modern receivers is shown in Fig. 4-1. Sync separation (and noise limiting) occurs in the left-hand section of the tube. The other section is the AGC keyer.

The normal input signal to the sync separator is shown in Fig. 4-2. It is checked at point A with a low-capacitance probe.

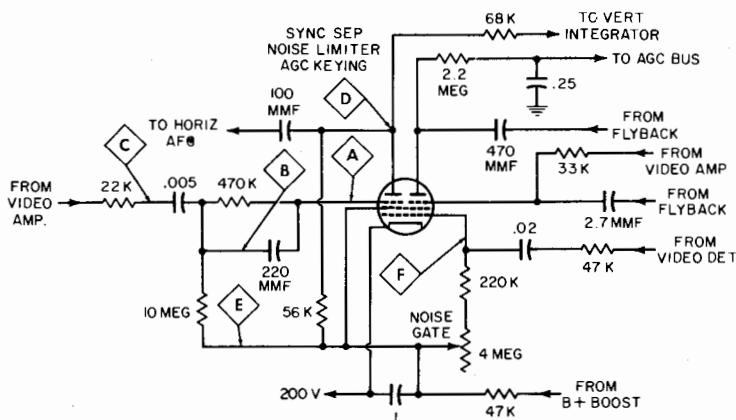

Fig. 4-1. Typical sync-separator configuration.

(Unless an input signal is applied to the receiver from a pattern generator or TV antenna, only a random noise pattern appears.) Its normal amplitude is about 30 volts peak-to-peak. Although sync lock is maintained at lower amplitudes, substantial attenuation results in unstable sync or complete loss of picture

synchronization. If the amplitude of the signal at point A is low, check the signal at points B and C. An open capacitor in the grid circuit causes excessive attenuation and waveform distortion. If the .005-mfd coupling capacitor is leaky, the DC grid bias on the tube is changed and the tube and circuit characteristics are shifted. As a result, the waveform at point A becomes blurry and attenuated (Fig. 4-3).

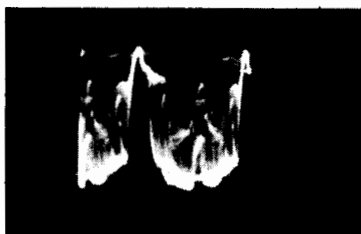

Fig. 4-2. Input to sync separator.

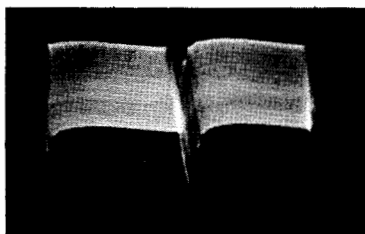

Fig. 4-3. Coupling capacitor leaky.

If the signal is normal at point A, the next check is made at point D, the plate of the sync separator. The normal waveform at this point consists of cleanly separated sync pulses (Fig. 4-4), with only a slight trace of residual video signal along the top. If the waveform is normal at point D, horizontal locking trouble is logically sought in the AFC or horizontal-oscillator section. Likewise, vertical locking trouble will be due to a defect in the vertical integrator or vertical oscillator. But in the event that the waveform at point D is not normal, and has appreciable residual video signal (Fig. 4-5), there is probably a defective component in the plate circuit. The 100-mmfd coupling capacitor may be leaky, for example.

Faulty sync separation can also be caused by a defect in the cathode circuit. In order to trace this signal, check the waveform at point E. A low-amplitude video signal (about 5 volts peak-to-peak) normally appears. Little or no signal at this point commonly is caused by leakage in the 0.1-mfd cathode bypass capacitor. However, if this capacitor is open, sync separation is not so seriously disturbed.

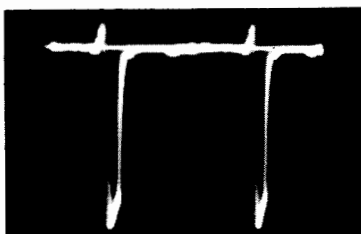

Fig. 4-4. Normal separated sync signal.



Fig. 4-5. Unsatisfactory sync separation.

The first grid in the tube (Fig. 4-1) is common to both sections. It operates in the noise-gate circuit. A low-amplitude negative-going signal (about 0.2 volt peak-to-peak) from the video detector is applied to point F, and appears as shown in Fig. 4-6. The signal amplitude is normally too low to affect sync separation unless a high-level noise pulse arrives. The high negative peak voltage of the noise pulse cuts the tube off for the duration of the pulse. Thus, a "hole" is punched in the separator output signal and sync stability is far better than if the noise-gate circuit were not used.

In case the .02-mfd coupling capacitor to the noise-gate grid is open, the negative-going video signal obviously does not feed into the grid circuit, and the noise gate becomes inoperative. This is of no consequence during strong-signal reception. Hori-



Fig. 4-6. Noise-gate signal applied to point F.

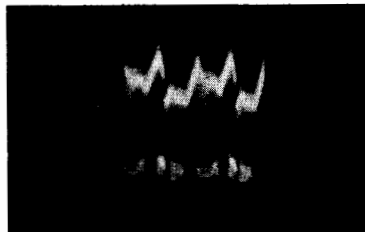

Fig. 4-7. Distortion of video signal, due to loss of horizontal sync.

zontal sync becomes less stable however on weak and noisy channels, because high-level noise pulses then feed through to the AFC circuit. However, if the .02-mfd coupling capacitor is leaky, the picture disappears and a video signal is not found at point F. What happens here is that DC voltage bleeds through to the video detector and "kills" the video signal, unless the noise-gate control is set to a high-resistance value.

The foregoing explanation of sync separation is typical. Although numerous variations in circuitry occur, particularly in older types of chassis, the general principles are the same. The sync separator always operates to strip the sync tips from the composite video signal, permitting the passage of little or no residual video. If a noise-gate circuit is used, its action is to punch a "hole" in the separated sync signal for the duration of high-level noise pulses. The technician should consult the receiver service data in each case, to determine the normal waveforms and peak-to-peak voltages.

One note of caution—the normal waveforms are sometimes distorted because of reflected trouble from the horizontal-AFC or -oscillator circuit. Receivers having keyed AGC may generate spurious AC voltages on the AGC line when the picture



is out of horizontal sync. This spurious AC can "chop up" the video-signal input to the sync separator as shown in Fig. 4-7. To avoid being misled in this situation, clamp the AGC line with a bias box or a battery, before checking waveforms in the sync section.

### READJUSTMENT OF VERTICAL-CENTERING CONTROL

In signal-tracing procedures, the scope pattern may not be centered on the screen. This depends upon the waveform. Re-adjustment of the vertical-centering control is sometimes required to prevent the top or bottom of the waveform from extending off-screen. Fig. 4-8 shows a sine waveform centered on the screen. If the beam-resting level is centered, the sine-wave pattern will also be centered, in consequence of the waveform symmetry.

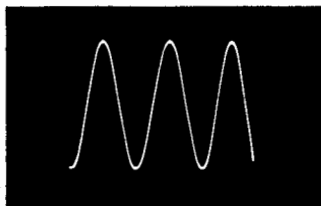
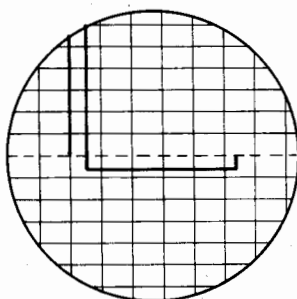
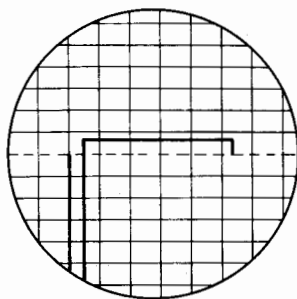

Fig. 4-8. Centered sine-wave pattern.

Next consider the display of a positive or negative pulse voltage, as in Fig. 4-9. With the beam-resting level centered on the screen, the pulse waveforms are decentered upward or downward, depending on the pulse polarity. The vertical-centering control must be readjusted to center the pulse waveform. Service scopes do not have automatic centering circuits. Therefore, whenever the waveform is poorly centered, the operator must readjust the vertical-centering control.



(A) Positive pulse.



(B) Negative pulse.

Fig. 4-9. Display of positive and negative pulses.

Some specialized scopes do have automatic centering circuits. This is accomplished by use of a DC restorer diode, as shown in Fig. 4-10. The beam-resting level is adjusted to a suitable point, such as one inch from the bottom of the screen. Then, when a waveform voltage is being displayed, the restorer generates a DC bias automatically which clamps the bottom of the waveform to the preset level. Either a positive or a nega-

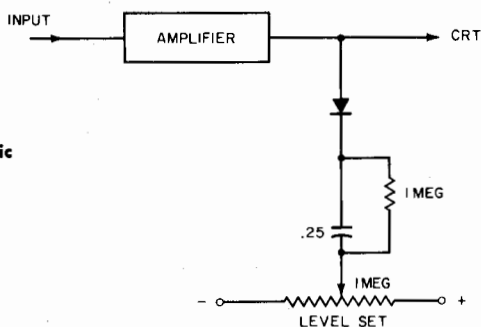

Fig. 4-10. Circuit for automatic centering.

tive pulse appears with the lower peak of the waveform clamped to this level. Thus, with the vertical-gain control adjusted for normal pattern height, all waveforms are automatically centered on the screen, regardless of their shape.

### SWEEP FREQUENCY FOR WAVEFORMS WITH ALTERNATE SYMMETRY

Sometimes waveforms have alternate symmetry, as seen in Fig. 4-11. Adjacent peaks have different voltages, but alternate peaks have the same voltage. These waveforms must be displayed with an even number of peaks in the pattern, i.e., 2, 4, etc. If you attempt to display a pattern with 1 peak, or

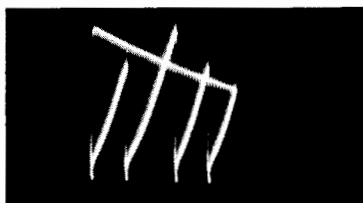

Fig. 4-11. Waveform with alternate symmetry.

3 peaks, for example, the result is an unsatisfactory blur. The reason for this is that the sweep oscillator locks in first on a low peak, and then on a high peak, when an odd number of peaks is displayed. Thus high and low peaks overlap, or the waveform "jumps one step" on each forward trace. This makes

a blurred display. On the other hand, with an even number of peaks in the pattern, the sweep oscillator locks each time on the same type of peak. The result is a clear pattern.

An even number of peaks is displayed in the pattern when the fine-frequency control is adjusted to a suitable point. If the pattern locks in a blurred aspect at first, merely turn the fine-frequency control higher or lower. As the next locking frequency is approached, an unblurred pattern will suddenly fall into lock. This is not a difficult point in scope operation, but it may be confusing to the beginner. Receiver service data generally recommends the display of two complete cycles in reference patterns. If this rule is followed, blurred and overlapping displays will not occur.

Waveforms with alternate symmetry are commonly found when checking the B+ supply voltage to a sync-separator or sync-amplifier tube, for example. There may be excessive ripple voltage on the supply line, due to defective decoupling capacitors, or failing filter capacitors in the power supply. Excessive ripple modulates the sync signal, and can cause picture pulling, rolling, or complete loss of sync.

Typical causes of alternate symmetry are as follows. The vertical-output stage usually has a heavy current demand at 60-cycle intervals. The power-supply ripple frequency in many receivers, however, is 120 cycles. With marginal filter capacitors, or faulty decoupling circuits, these two ripple waveforms beat, and the resultant ripple waveform has alternate symmetry.

The 120-cycle ripple from a full-wave power supply displays more or less alternate symmetry unless the secondary of the power transformer is center-tapped exactly (equal voltages applied to each rectifier), and unless each rectifier has the same plate resistance (or front-to-back ratio in contact rectifiers). Also, one side of the center-tapped secondary may be loaded by an auxiliary half-wave power supply in some receivers.

### **SYNC SEPARATOR WITH PHASE-INVERTER STAGE**

Many TV receivers have a sync-separator triode followed by a phase-inverter stage, as shown typically in Fig. 4-12. The separator operates as discussed previously, with composite video signal at points A through D. The signal amplitude is about 30% lower at point D than it is at point A. The 10-K resistor prevents the separator input from loading the video amplifier objectionably. Between points B and D, the RC network serves to attenuate noise impulses to some extent. In turn, the horizontal sync pulse at point D normally appears rounded, compared with its shape at point A.

If the output signal at point E is weak or absent, check with a low-capacitance probe from point A through point D. Normal output from the sync separator is shown in Fig. 4-13. If an open, leaky, or shorted capacitor, or off-value resistor is attenuating or distorting the grid-input signal, the separator output will be affected accordingly.

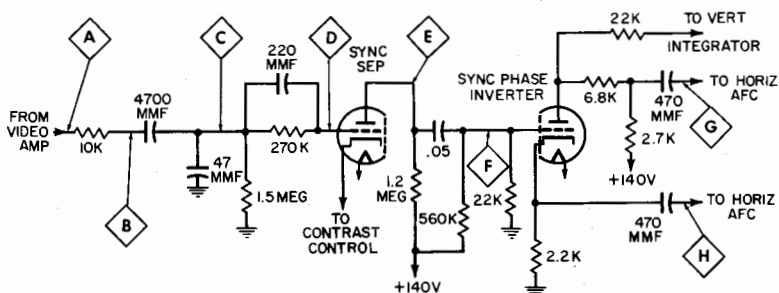

Fig. 4-12. Sync-separator and phase-inverter configuration.

The waveform amplitude from point E to point F does not change appreciably in normal operation. However, there is somewhat less residual video signal at point F because of the filtering action of the RC coupling network. Normal amplitude at point F is about 15 volts peak-to-peak. If substantially less, check the .05-mfd coupling capacitor. If the capacitor is open, horizontal-sync lock becomes quite unstable, vertical-sync



Fig. 4-13. Normal sync-separator output signal.

lock is lost completely, and the picture rolls. The vertical-sync pulse is completely unable to couple into the phase-inverter grid via stray capacitance, while a residue of horizontal sync does transfer.

### Phase-Inverter Action

The sync phase inverter provides stripped sync pulses in opposite polarities to the AFC section. Outputs are taken from both the plate and the cathode of the inverter triode. These waveforms have opposite polarity, as shown in Fig. 4-14. Note how sawtooth components are added to the waveforms points at G and H. These are comparison waveforms from the sweep

section which are fed back into the AFC circuit. Thus, waveforms at the inverter output are a combination of signal and self-generated voltages.

How does the inverter stage work? Recall that the output from a triode amplifier (plate output) has a  $180^\circ$  phase shift with respect to the grid-input signal. Or, the plate output for a complex waveform is "turned upside down" with respect to the grid waveform. Also, the output from a cathode follower has  $0^\circ$  phase shift with respect to the grid-input signal, that is, the cathode output is a replica of the grid input. The phase-inverter stage combines these two circuit actions.



(A) At (G).



(B) At (H).

Fig. 4-14. Phase-inverter outputs.

Suppose one of the 470-mmf coupling capacitors is open. In that case, the sawtooth component only would be displayed in the Fig. 4-14 waveform. If there were a defect in the sawtooth feedback circuit in the AFC section, only the sync-pulse component would be displayed in the Fig. 4-14 waveform.

The sync-pulse amplitudes are approximately equal at points G and H in Fig. 4-12 under normal conditions. If you find a substantial difference in amplitudes, check the resistors in the inverter output circuit. A change in load impedance causes a corresponding change in waveform amplitude. The waveform detail at points G and H is not identical because the inverter plate feeds the vertical integrator, as well as the AFC circuit. The plate-load impedance has somewhat different reactance from the cathode-load impedance in the inverter stage.

The waveforms in Fig. 4-14 represent the display for a picture in horizontal sync. If the picture is tearing or out of sync, the relation of the pulse to the sawtooth changes. Try then to adjust the horizontal-hold control so that the picture is in horizontal sync. If it is impossible to hold the picture in lock, the sync pulses will "ride" the sawtooth component. Although the pattern is more difficult to evaluate under this condition, its essential features can be noted.

## CIRCUITRY VARIATIONS

There are numerous variations in sync-separator circuitry. The basic principle is the same in all, however. The foregoing illustrations put the technician in a good position to tackle trouble in any sync circuit. The important considerations are to keep in mind how the sync section works, how to make progressive waveform tests correctly, and not to take anything for granted. When in doubt, consult the receiver service data.

It is a highly dubious procedure to attempt troubleshooting the sync section without referring to specified waveforms for



Fig. 4-15. Sync-separator outputs from two different receivers.

the particular chassis because these can vary widely and unexpectedly. This point is illustrated in Fig. 4-15 which shows sync-separator outputs for two different receivers. The first waveform displays no visible residual video in the stripped sync, while the second contains appreciable residual video. Each of these waveforms is normal for the particular chassis. The AFC sections have more or less relaxed requirements for the individual receivers in this regard.

In the second example, trouble in the sync section results in excess residual video, as seen in Fig. 4-16, and horizontal sync is impaired. Thus in these circumstances the only reliable guide is the service data for the particular receiver. Finally, it is well to remember that all waveforms have a reasonably normal tolerance, but do not confuse tolerance with trouble symptoms. This is an essential part of waveform analysis. Waveform amplitudes may vary  $\pm 20\%$  and still be within normal tolerance, unless otherwise specified.

There are normal tolerances on waveshapes, though these are more difficult to set forth in a cut-and-dried format. Beginners sometimes suppose that a sync pulse should have distinct and squared corners, as in Fig. 4-17. Such well-defined sync pulses may not even be found normally at the picture-detector output, and are never found at the sync-separator output (see Fig. 4-15). In fact, the amplitude of the sync pulses is much more important than their shape, from the standpoint

of sync-section operation. There is, of course, no drawback to maintenance of well-defined pulses in the receiver circuitry. The essential point is that the squareness or roundness of the pulse has no practical effect upon the end result of circuit action.

Quite the contrary consideration is encountered in other receiver sections. For example, a blanking pulse that is not sufficiently flat-topped or is too narrow will leave some of the retrace lines unblanked; or, if too wide, will blank out part

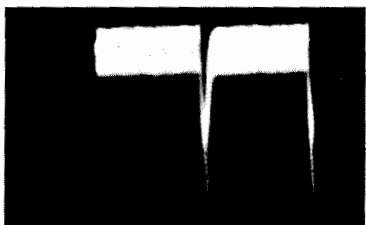

Fig. 4-16. Excessive residual video in the stripped-sync waveform.



Fig. 4-17. Sync pulses that have distinct corners.

of the desired picture. Obviously, proper evaluation of tolerance on waveshapes comes with experience and understanding.

As you proceed with the following chapters, these points will become clearer. Proper evaluation in each situation hinges upon the basic features of circuit action. The purpose of the network must first be understood. Then the means by which this purpose is accomplished must be mastered. In due time, it becomes almost second nature for you to separate automatically the normal tolerances from the trouble symptoms.

## CHAPTER 5

# Troubleshooting the AFC and Horizontal-Oscillator Section

The AFC section has two signal inputs, one from the sync separator, and the other from the horizontal oscillator. Signal tracing in this section is accomplished with a low-C probe. The receiver should be driven by a pattern generator or from a TV antenna. A typical horizontal-oscillator and -AFC configuration is illustrated in Fig. 5-1. Signal tracing starts with a check of the input from the sync separator (point A) and its passage through the 100-mmf coupling capacitor.

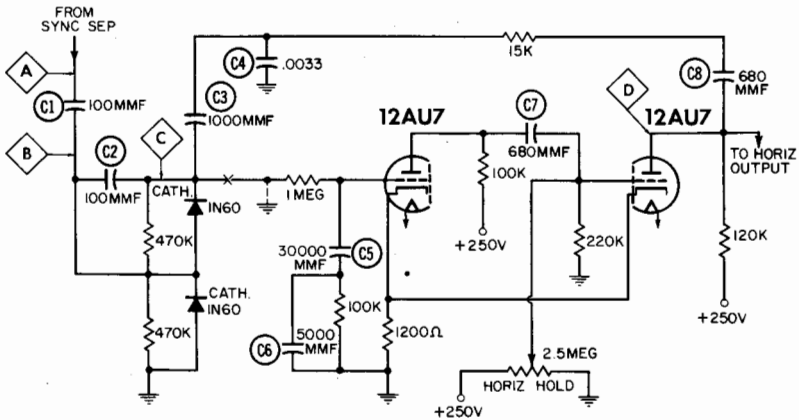

Fig. 5-1. Typical horizontal-oscillator and -AFC configuration.

Normally, a waveform is found at point A, as shown in Fig. 5-2. If absent or seriously distorted, the sync trouble is due to a defect in the sync separator, and not in the AFC circuit. But if the sync separator is supplying a normal signal, check next at point B. It might be expected that the same waveform would be found here as at point A, but this is not the case. The reactance of the 100-mmf coupling capacitor causes the wave-shape to be different for the reason that it becomes mixed, to some extent, with a sawtooth component from the horizontal



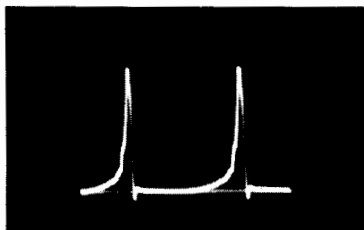

Fig. 5-2. Normal input waveform obtained from the sync separator.

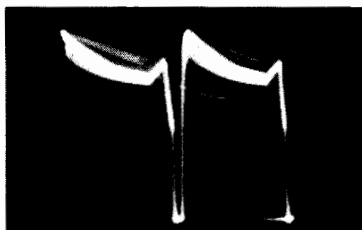

Fig. 5-3. Normal waveform at output end of coupling capacitor.

oscillator. The same waveform appears at points B and A only when the oscillator is inoperative. (See Fig. 5-3.)

The sawtooth waveform from the horizontal oscillator (Fig. 5-4) enters the AFC circuit at point C in Fig. 5-1. But suppose that capacitor C2 becomes leaky. The waveform then does not change in amplitude appreciably, but it becomes distorted as seen in Fig. 5-5. Horizontal locking is unstable under this condition. When waveform tests throw suspicion on a circuit, measure the DC voltages and resistances. Test the capacitors on a capacitor checker, or by substitution. Note in Fig. 5-1 that the 1N60 AFC diodes may become defective, and cause waveform changes. The diodes can be checked out for front-to-back ratio with an ohmmeter, or a substitution test can be made.

The AFC circuit is basically a waveform comparison configuration. The incoming sync pulses are mixed with a sawtooth wave from the oscillator. The mixed waveform is fed to the AFC diodes, and rectified. This rectified DC voltage is fed to the grid of the first tube in the multivibrator (oscillator) circuit. When this DC bias voltage is positive, the oscillator speeds up; when it is negative, the oscillator slows down.

The polarity of the DC output voltage from the AFC diodes depends on the phase of the sawtooth wave with respect to the sync pulses. When the pulses ride on top of the sawtooth

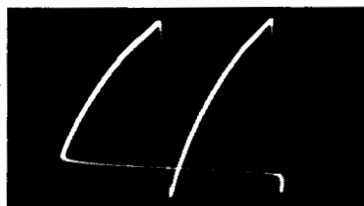

Fig. 5-4. Normal sawtooth waveform from horizontal-oscillator circuit.



Fig. 5-5. Sawtooth waveform from horizontal-oscillator circuit, when coupling capacitor is leaky.

wave, the mixed waveform has a high peak-to-peak voltage. When the pulses ride part way down on the sawtooth wave, the mixed waveform has a lower peak-to-peak voltage. If a change in oscillator frequency (pulling) causes the sync pulses to ride lower on the sawtooth in one diode circuit, the opposite is the case for the other diode circuit. The DC output from the AFC diodes will swing positive or negative, depending upon which way the oscillator is pulling; that is whether it is trying to run too fast or too slow.

### OSCILLATOR OR AFC TROUBLE?

Sometimes the receiver acts as if the oscillator were running so far off-frequency that the AFC circuit cannot pull it into sync. A simple test can be made to determine whether the trouble is in the AFC section or the oscillator section. Disconnect the 1-meg isolating resistor as indicated at X in Fig. 5-1, and ground the disconnected end of the resistor as indicated by the dotted-line connection. If the trouble is in the AFC circuit, it will be possible to free-wheel the picture into horizontal sync (at least momentarily) by critical adjustment of the horizontal-hold control. If the picture cannot be framed, the trouble is in the oscillator circuit.

This test is based on the principle that a normal oscillator operates at about 15,750 cycles when the AFC control voltage is zero. Hence, the control voltage is set to zero by this test connection, to see whether the oscillator is capable of normal operation.

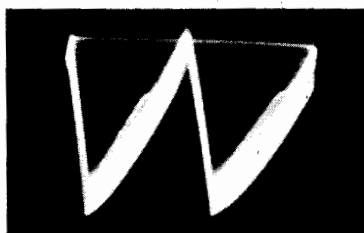

Fig. 5-6. Distorted waveform appears at (B) when C1 is open.

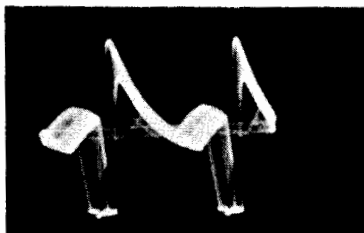

Fig. 5-7. Waveform at (B) becomes distorted when C2 is open.

Although the circuit may look complex, it is merely an assembly of basically simple components. Therefore, the attack on a defective circuit is first of all a check of the individual components. Note here too that Ohm's law applies to reactance and to impedance in the same general manner as to resistance.

In case C1 is open, horizontal sync lock becomes extremely touchy. The waveform at point B in Fig. 5-1 does not exhibit

a prominent sync-pulse component, but becomes a distorted sawtooth (Fig. 5-6). The sawtooth amplitude is less than that of the normal waveform, because the pulse component is missing.

When C2 is open, the waveform at point B becomes distorted as in Fig. 5-7. Although it might be expected that an open capacitor would cause a decrease in waveform amplitude, that is not the case here. The diode response changes when the capacitor is open, and the waveform amplitude doubles, approximately. Stability of sync lock is not greatly affected on strong channels, but becomes unstable on weak-channel reception. Note that the waveform in Fig. 5-7, as in the case of previously illustrated waveforms, is taken with the picture framed in horizontal sync. This is important because the AFC waveforms often become considerably changed and blurry if the picture is out of horizontal sync. When checking the waveforms, look at the picture occasionally to see whether or not it is still in sync. If not in sync, adjust the horizontal-hold control as required, even if the adjustment is critical.

If C3 is open, the distorted waveform in Fig. 5-8 appears at point B. The waveform has about double normal amplitude, due to the increase in circuit impedance when C3 has no loading action. The comparison waveform (oscillator sawtooth) is absent, and therefore the picture cannot be framed horizontally unless the 1-meg resistor is disconnected and grounded as shown by the dotted lines in Fig. 5-1. Then, the picture can be free-wheeled into frame by careful adjustment of the horizontal-hold control.

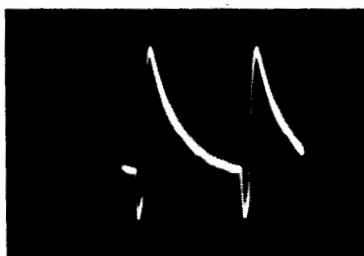

Fig. 5-8. Waveform at (B) when C3 is open.

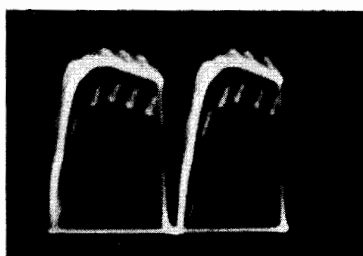

Fig. 5-9. Distorted waveform at point B when C4 is open.

Again, if C4 is open, a distinctive distortion occurs in the waveform at point B, as shown in Fig. 5-9. This distorted waveform has an amplitude several times higher than normal. When C4 is open, its normal attenuating or bypassing action is removed, and the sawtooth comparison wave increases substantially in amplitude.

## SIGNAL-TRACING THE HORIZONTAL-OSCILLATOR SECTION

When the horizontal oscillator is inoperative, the screen is dark because there is no drive to the horizontal-output tube, and therefore no high voltage to the picture tube. Faults other than oscillation failure also cause a dark screen; for example, when C5 is open (Fig. 5-1). The oscillator continues to function, but at an incorrect frequency. When the drive to the horizontal-output tube is considerably off-frequency, the high-voltage output falls so low that the screen becomes dark. Also, when C5 is open, the grid circuit of the multivibrator input tube becomes very high, and spurious feedback occurs through the AFC section into other receiver sections. This spurious feedback oscillation is audible, and is called squegging. Squegging may also generate excessive spurious voltages which can break down some components.

All waveforms throughout the AFC and oscillator section become highly distorted when the receiver is squegging. For example, Fig. 5-10 shows the distorted waveform at point B in Fig. 5-1. Its amplitude is considerably higher than that of the normal waveform. A similar trouble symptom occurs when C6 is open, but the squegging frequency is higher, and the screen does not go dark. The picture will not lock horizontally of course. All waveforms in the horizontal section are distorted, and the waveform at point B appears as in Fig. 5-11. Its amplitude is considerably higher than normal.

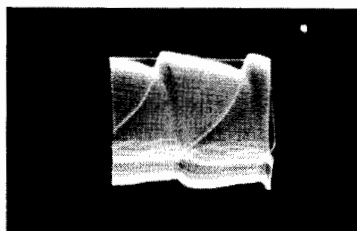

Fig. 5-10. Distorted waveform at point B when C5 is open.

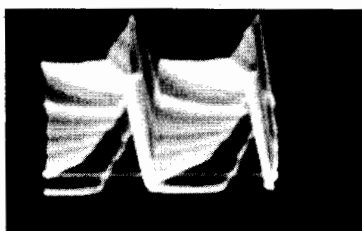

Fig. 5-11. Distorted waveform at point B when C6 is open.

The normal output waveform from the horizontal oscillator is seen in Fig. 5-12. It is a peaked-sawtooth waveform which drives the horizontal-output tube, and is checked at point D in Fig. 5-1. Normal amplitude is 130 volts peak-to-peak. Reduced amplitude can be caused by either leakage or loss of capacitance in C7. Or, if C7 is completely open, the oscillator stops and the screen is dark. The symptoms of leakage and low capacitance are shown in Fig. 5-13. Fig. 5-13A shows the distorted waveform which appears when C7 is quite leaky, and

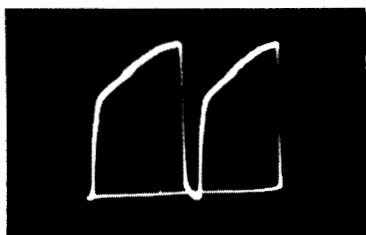
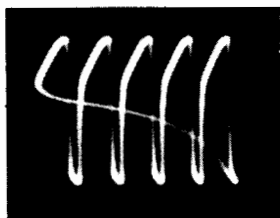
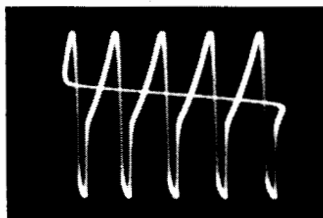

Fig. 5-12. Normal output waveform from horizontal oscillator.

Fig. 5-13B shows the effect of capacitance loss. Both waveforms appear at point D, and both have more cycles than usual in the pattern when the scope deflection rate is set for 7,875 cycles. More cycles appear than usual, because defects in C7 slow down the oscillator. Although the horizontal-hold control is turned to the end of its range, the picture may be broken up into diagonal strips.



(A)



(B)

Fig. 5-13. Waveform symptoms of defects in C7 of Fig. 5-1.

When C8 in Fig. 5-1 is open, the picture-tube screen is dark. If C8 is leaky, the picture is present but horizontal sync is unstable. Waveform symptoms of these defects in C8 are shown in Fig. 5-14. With C8 open (Fig. 5-14A), the waveform at point D in Fig. 5-1 is greatly reduced from its normal amplitude. Also, the oscillator runs too slowly, causing more cycles than usual to appear in the pattern. Low drive and low-frequency output combine to darken the picture-tube screen. If C8 is leaky, the oscillator can usually be adjusted to operate temporarily at 15,750 cycles, but continual drift necessitates

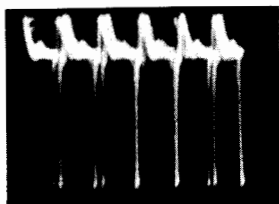

(A)

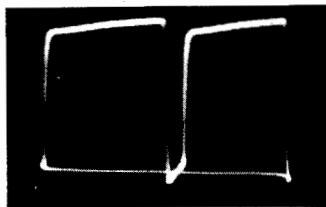

(B)

Fig. 5-14. Waveform symptoms of defects in C8 of Fig. 5-1.

frequent resetting of the horizontal-hold control. The waveform at point D (Fig. 5-14B), is considerably distorted, but is almost normal in amplitude.

In addition to defective capacitors, off-value resistors or incorrect B+ supply voltage can cause trouble in horizontal-oscillator operation. Incorrect resistance values are easy to localize, therefore, the resulting waveform distortions are not shown here.

The foregoing discussion is concerned with a particular circuit configuration, but the general principles developed apply to other configurations. The essential procedure here is to check the observed waveshapes and amplitudes against the service data for the particular receiver, and, when deviations are noted, analyze the pattern for the information which it contains.

### SYNCHROGUIDE RINGING-COIL CHECK

Some horizontal-oscillator circuits, such as the Synchroguide configuration shown in Fig. 5-15, have a ringing coil for stabilization of the oscillating frequency. The ringing coil is shown at  $L_a$ . To check the slug adjustment, connect a low-C probe as indicated, and observe the peaks of the waveform displayed on the scope screen. The pattern comprises a combination pulse and sine wave in which the positive peaks normally have the same horizontal level, as illustrated. If the pulse peaks are higher or lower than the sine-wave peaks, adjust the slug in the ringing coil as required.

A circuit defect is present, unless the peaks can be brought to the same height. The Synchroguide circuit uses a pulse-width method of generating control bias to the horizontal blocking oscillator. The control tube in Fig. 5-15 is biased beyond cutoff. In other words, the grid is held highly negative with respect to the cathode (-14 volts is typical). A sawtooth voltage (Fig. 5-16A) is fed back from the blocking oscillator and combined with the sync pulse at the grid of the control tube. This waveform is seen at point A in Fig. 5-15.

The positive peak of this combination waveform reduces the DC grid bias so that the control tube can conduct. Tube conduction generates a positive voltage in the cathode circuit (across  $R_g$  in Fig. 5-15). This voltage reduces the negative grid bias at the oscillator, causing it to speed up. The value of the positive voltage which is thus generated depends upon the phase relation between the sawtooth voltage and the pulse. Note in Fig. 5-16A how part of the pulse rides on top of the sawtooth, but how part also falls down on the steep portion of the sawtooth, and does not contribute to the conduction interval.

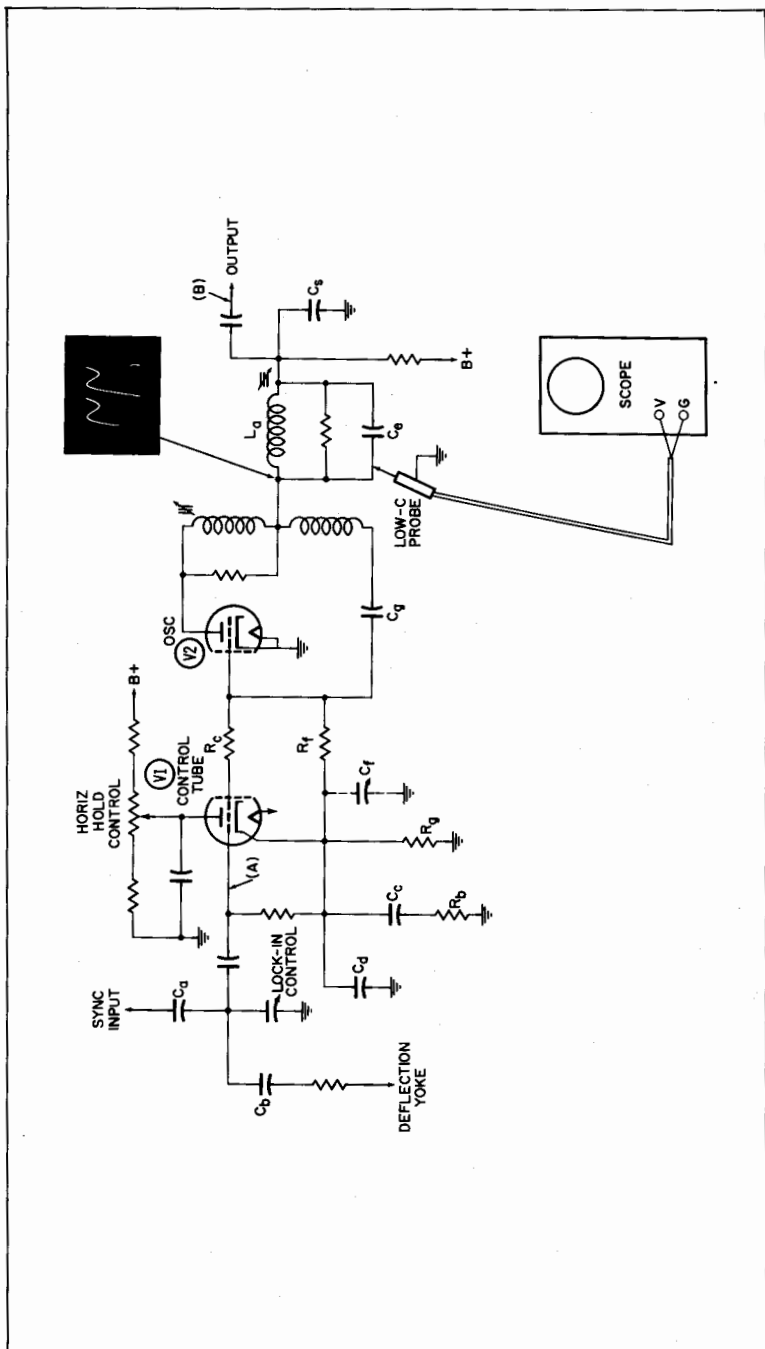

Fig. 5-15. Signal check of Synchroguide ringing-coil adjustment.

If the pulse moves slightly to the left on the sawtooth, more of the pulse appears on top thus making the conduction interval longer. In turn, more positive bias is generated and the oscillator speeds up. The sawtooth then pulls to the right, part of the pulse is lost, and, effectively, the pulse width decreases. Equilibrium occurs at the width which keeps the sawtooth frequency exactly in step with the sync pulse.

Component defects in either the control stage or the oscillator stage can cause the oscillator to pull excessively. The pulse



(A) At point A.

(B) At point B.

Fig. 5-16. Normal Synchroguide waveforms.

width is narrower or wider than normal, causing inability to bring the peaks of the waveform in Fig. 5-15 to the same level. Leaky capacitors are a common cause of this difficulty. The leakage changes the normal DC voltage distribution in the system, forcing the control bias from its normal range. Off-value resistors are less likely to cause pulling, but they should be checked in case the capacitors are good. The transformer is checked last, because it is an infrequent cause of operating trouble.

### RINGING-COIL AND MULTIVIBRATOR CONFIGURATION

In older receivers, you will often find the AFC tube controlling a multivibrator sawtooth generator which includes a ringing coil, as shown in Fig. 5-17. A comparison sawtooth from the sweep circuit (Fig. 5-18) is fed into the AFC diodes, where it is mixed with stripped sync from the phase inverter. The sawtooth has a normal amplitude of 15 volts peak-to-peak. If it is weak or absent, the multivibrator frequency is uncontrolled. Leakage or shorts in the .01-mfd capacitor are likely to be the cause.

Positive sync pulses are coupled to the plate of one AFC diode, and negative sync pulses to the cathode of the other diode, unless one of the 1000-mmf capacitors is open, or if trouble is present in the preceding inverter stage. Thus, both diodes are normally conducting simultaneously. At point A in Fig. 5-17 is seen a mixed pulse and sawtooth wave, as in Fig.



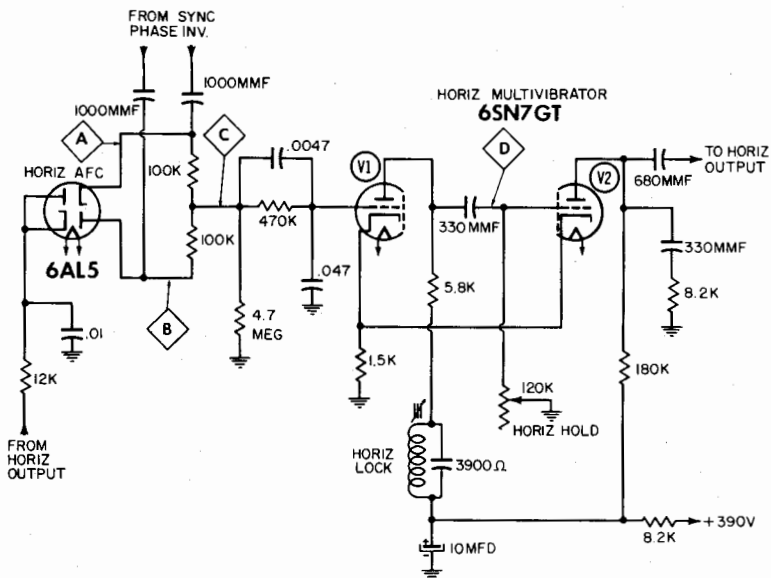

Fig. 5-17. Multivibrator with ringing coil.

5-19. The applied sawtooth voltage alternates above and below a zero level. Therefore, the mixed waveforms in the AFC tube will make the two diodes conduct equally.

If the multivibrator tries to drift to a higher frequency than the pulses, the feedback sawtooth falls more or less out of step with the pulses. At point A the pulse is riding down from the peak of the sawtooth, and the reverse at point B. In turn, the AFC diodes generate more negative DC at point C, and

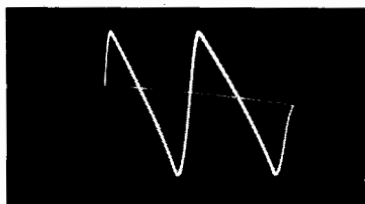

Fig. 5-18. Comparison sawtooth from the sweep circuit.



Fig. 5-19. Mixed pulse and sawtooth waveform.

the multivibrator slows down. Hence, the DC voltage at point C rises and falls, or may change polarity when the oscillator attempts to drift either in a low- or high-frequency direction. The equilibrium condition may represent either a positive- or negative-control voltage, depending on the setting of the horizontal-hold control.

At point D in Fig. 5-17 another key troubleshooting waveform is observed. This is a combination pulse and sine-wave pattern, as in Fig. 5-20. The pulse is generated by multivibrator action during the horizontal-retrace interval. The sine wave is generated by shock excitation of the horizontal-locking (ringing) coil. If the pulse does not ride on top of the sine wave, adjust the slug in the ringing coil as required. This is a stabilization adjustment. The sine wave causes multivibrator tube V2 to come out of cutoff rapidly instead of gradually. The noise immunity of the circuit is thus improved.

Fig. 5-20. Pulse and sine waveform.



The RC network in the grid of V1 is a filtering and holding configuration. It provides a smooth DC control voltage to the grid, and it also delays passage of sudden input changes. As a result, noise pulses tend to average out and the oscillator is less likely to tear the picture when the noise level is high. Look for open capacitors if appreciable AC is found at the grid of V1.

### CIRCUIT VARIATIONS

Although the end result is always the same in any AFC-oscillator configuration, different manufacturers employ wide variations in circuitry. Do not attempt, therefore, to evaluate waveforms without reference to the service data for the particular chassis. It is practically impossible for even experienced technicians to inspect a new circuit and deduce the correct waveforms and peak-to-peak voltages. Commercial circuits are too complex for such deductions to be drawn with any reasonable accuracy.

## CHAPTER 6

# Waveform Tests in the Horizontal-Sweep Section

The horizontal-sweep section has a reputation of being the "toughest" section in a TV receiver. While it is somewhat more complex than some of the other sections, logical waveform checks greatly simplify what can be a time-wasting trial-and-error procedure. Always check the drive waveform first, as shown in Fig. 6-1. This immediately sectionalizes a horizontal-sweep symptom. If the drive is absent or weak, the trouble is in the horizontal oscillator. Normal drive, however, indicates trouble in the sweep section.

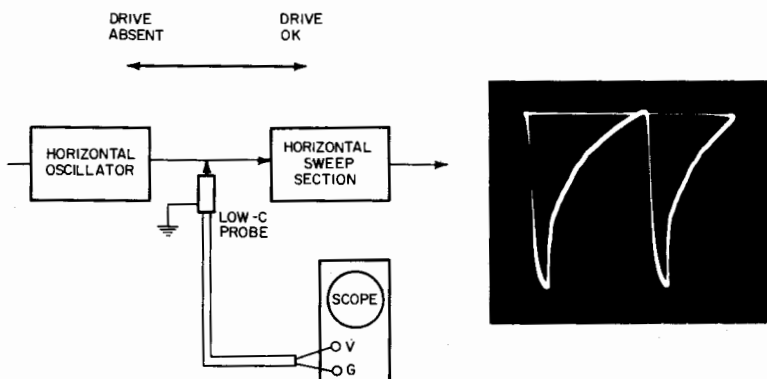

Fig. 6-1. Check drive first.

There is one exception to this general rule: if the horizontal oscillator should obtain plate-supply voltage from the booster circuit, weak drive can result from sweep-circuit defects which reduce the booster output voltage. In that case, confirm the possibility by measuring the boost voltage. If low, you can connect a bench power supply to the oscillator B+ line to restore normal drive.

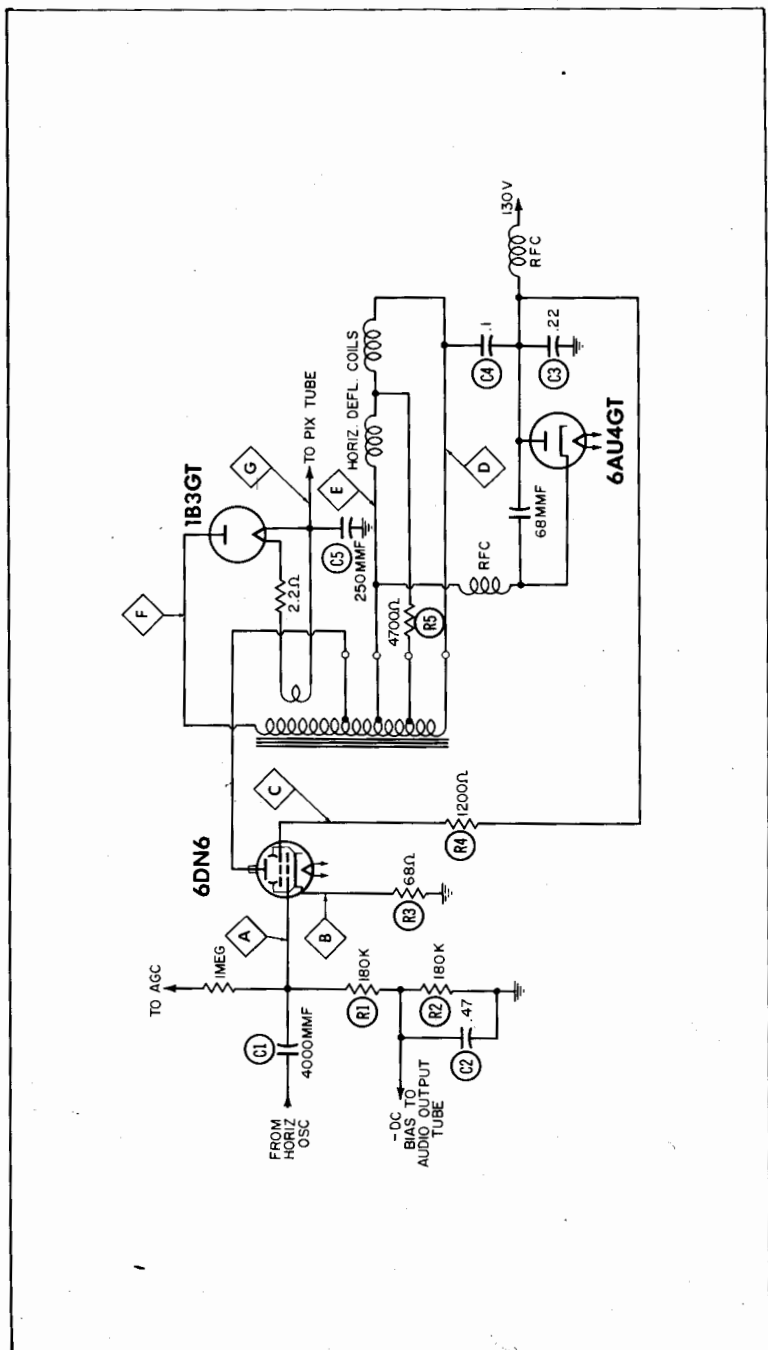
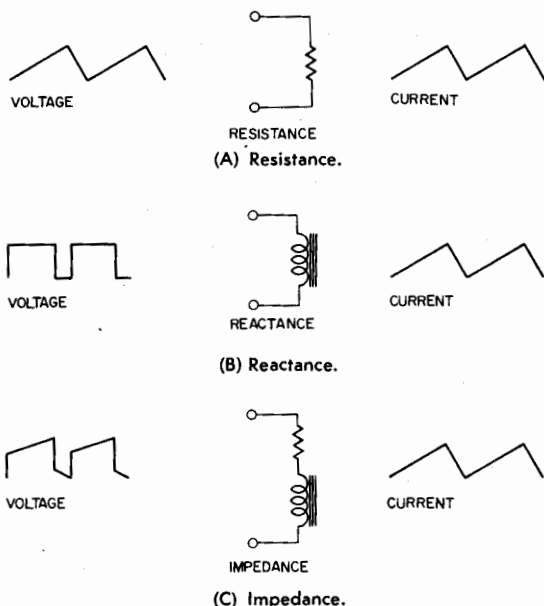

Fig. 6-2. Typical horizontal-sweep configuration.

## SWEEP-CIRCUIT TROUBLESHOOTING

The illustrated arrangement in Fig. 6-2 uses the popular auto-transformer circuit. This is the flyback transformer which matches the plate resistance of the 6DN6 output tube to the deflection-coil impedance for maximum power transfer. It also steps up the flyback pulse voltage for the high-voltage power supply.

The center-tapped yoke has a 4,700-ohm damping resistor to minimize ringing. Voltage and current waveforms in the deflection circuit have different shapes, because the circuit is



**Fig. 6-3. Voltage waveforms needed for a sawtooth current.**

reactive (inductive). A complex *voltage* drives the same *current* waveform through a *resistive* circuit. But this complex voltage drives a different current waveshape through a reactance or impedance, as depicted in Fig. 6-3. Both voltage and current waveforms are used in signal-tracing horizontal-sweep circuits.

Remember how the waveforms across the capacitor and across the resistor are different in a differentiating circuit. The capacitor waveform shows the AC voltage across the capacitive reactance, while the resistor waveform shows the AC current waveform into the capacitor. An inductor, however, is a reactance while the resistor waveform shows the AC current waveform into the inductor. This is the situation in Fig. 6-3C.

The drive waveform to the grid of the horizontal-output tube is a voltage waveform. It is checked at point A in Fig. 6-2, and normally appears as in Fig. 6-1. C1 has a value of 4,000 mmf. It has therefore appreciable reactance to the scanning frequency. While the horizontal oscillator supplies 90 volts peak-to-peak to the coupling capacitor, only 75 volts peak-to-peak are applied to the grid of the output tube. This is normal. If less than 75 volts peak-to-peak were found at the grid, the coupling capacitor would fall under suspicion unless the horizontal oscillator was not supplying normal output. When the capacitance of C1 is reduced, the drive waveform not only has reduced amplitude, but also becomes distorted from severe clipping of the positive peak. If C1 is completely open, no drive voltage reaches the grid of the output tube, and the picture-tube screen is dark.

### LOW DRIVE

Low drive voltage reduces the deflection current through the yoke and causes a narrow picture. Low drive also reduces the high-voltage output, and makes the picture dim. Although reduced high voltage causes picture blooming, the amount of blooming is less than that of the narrowing action when drive

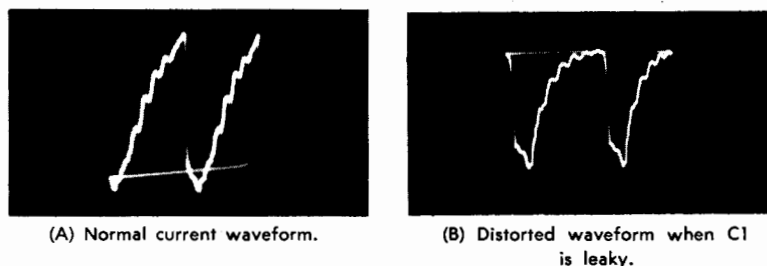

Fig. 6-4. Normal and abnormal waveform at point B of Fig. 6-2.

voltage is low. The normal cathode-current waveform is seen in Fig. 6-4A. The distorted current waveform which occurs when C1 is leaky is shown in Fig. 6-4B. The cathode-current waveform reflects various system faults because it is the sum of plate, screen, and grid current in the output tube. Leakage in C1 results in a narrow picture. This is due to reduction of grid bias at the output tube and consequent clipping of the drive waveform.

The normal waveform at the screen is shown in Fig. 6-5A, and the distorted waveform which appears when the screen resistor increases in value in Fig. 6-5B. When the resistance of R4 (Fig. 6-2) is too high, the picture becomes narrow. There

are two reasons for this symptom: first, too high screen resistance reduces the DC voltage to the screen grid, which limits the power from the tube; and second, the screen resistor is unbypassed in this configuration. When the screen resistor increases in value, the signal amplitude at the screen grid *increases*, although the DC voltage decreases. The screen-grid circuit operates as a triode plate-load circuit. When the load resistance is increased, the output signal voltage increases. In a beam-power tube, however, the useful power is not supplied by the screen grid, but by the plate. The screen-grid signal is  $180^\circ$  *out of phase* with the control-grid signal.

The screen grid has an amplification factor which is less than the control-grid factor. For this reason an increase in screen-signal amplitude reduces the output from the plate. Or, the unbypassed screen grid has a degenerative action. Compare this action with the signal at the cathode point B in Fig. 6-2. Here the signal is *in phase* with the control-grid signal. The cathode signal is nevertheless degenerative for the reason that a positive-going signal at the cathode decreases the plate current, while a positive-going signal at the grid increases the plate current.

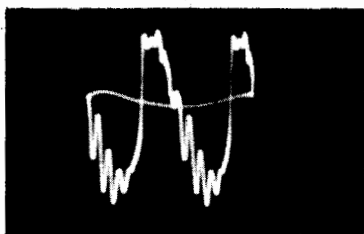

(A) Normal waveform.

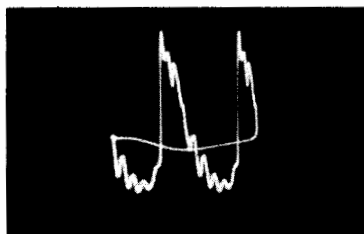

(B) Distorted waveform caused by increase in value of R4.

Fig. 6-5. Normal and abnormal waveform at point C of Fig. 6-2.

### NARROW PICTURE

The normal waveform at point D is shown in Fig. 6-6. A very narrow picture can be caused by an open in C4, in which case the waveform at point D becomes highly distorted, as seen in Fig. 6-7. If C4 is leaky, the change in waveshape is not marked but its amplitude becomes less. Again, the picture symptom is a reduction in width. These examples show how useful the scope can be in troubleshooting the horizontal-sweep section. Various component defects which cause the same picture symptom are distinguished by the different changes imposed on circuit waveforms. A narrow-picture symptom, for example, need never be tackled on a guesswork trial-and-error basis. Logical

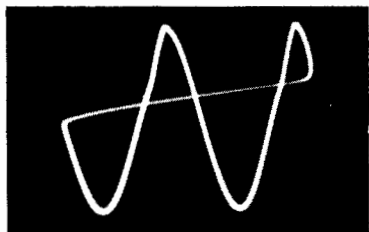

Fig. 6-6. Normal waveform at D in Fig. 6-2.

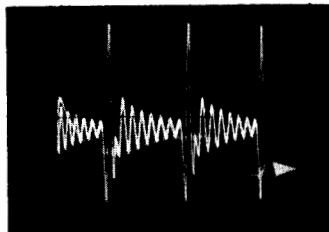

Fig. 6-7. Distorted waveform at point D when capacitor C4 is open.

application of the scope usually will permit the technician to close in rapidly and certainly on the defective component.

A 2,500 volt peak-to-peak pulse (Fig. 6-8) is normally found at point E in Fig. 6-2. This high voltage cannot be tested with a low-capacitance probe, and a high-voltage capacitance-divider probe is used to display the waveform. If the value of R5 is incorrect, the ringing along the bottom of the waveform (Fig. 6-9) becomes more prominent. Ringing becomes most severe when R5 is completely open. This is a useful quick test to determine whether ringing bars in the raster are being caused by a sweep-circuit defect, or by a spurious modulation of the video signal. Ringing bars which originate in the sweep section will show up invariably in the waveform at point E in Fig. 6-2. However, if there is little or no ringing in the waveform at point E, the source of the ringing bars is other than in the sweep section.

A confirming test is made by connecting a 0.25-mfd capacitor from the output lead of the video amplifier to ground. If the "ringing bars" disappear, the spurious voltages are coming from the video section. The cause may be a missing high-voltage cage, or poor grounding of a cage which therefore permits ripple from the high-voltage section to be picked up by the video input lead to the picture tube. Picture-tube extension cables are particularly likely to pick up stray fields from the high-voltage section and cause mysterious "ringing bars" in the raster.

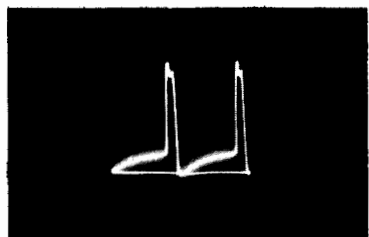

Fig. 6-8. Normal waveform at point E.

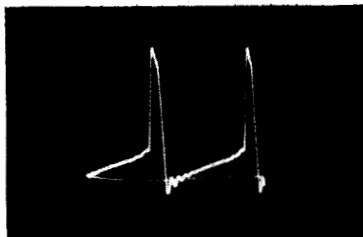

Fig. 6-9. Distorted waveform at point E resulting from increase in value of R5.



## HIGH-VOLTAGE POWER SUPPLY

The high-voltage power-supply circuitry is comparatively simple, as seen in Fig. 6-2. Technicians usually make an arc test with a screwdriver at point F, but this gives only an extremely rough estimation of the waveform amplitude. In order to measure the amplitude and inspect the waveshape, a special high-voltage capacitance-divider probe is required. Note that it is not completely informative merely to clip a probe on the insulation to the 1B3 plate lead. Even though the true waveform is displayed, variations in thickness of insulation and effective capacitance cause a change in scope calibration from one chassis to another.

A professional-type test is made with the special high-voltage capacitance-divider probe illustrated in Fig. 6-10. An inch or two of coax from which the braid has been stripped is taped against the stripped end of a coax input cable to the scope. This arrangement forms a capacitance-divider probe, which can

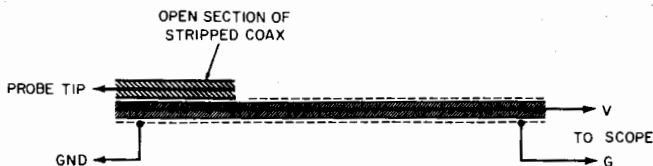

Fig. 6-10. Special high-voltage capacitance-divider probe.

be calibrated for an exact 100-to-1 voltage division. This calibration is accomplished either by proper selection of the open-section length, or by connecting a suitable value of capacitor (a trimmer capacitor can be used) across the output end of the scope-input cable.

The easiest way to calibrate the probe is first to select a waveform—in the horizontal section—which can be displayed with a direct probe, such as the waveform across a booster capacitor, or at the screen grid of the output tube. Then, check the same waveform with the high-voltage capacitance-divider probe, advancing the scope's decade step attenuator two positions (this makes the scope 100 times more sensitive). The waveform then appears at the same amplitude on the scope screen if the probe is correctly adjusted.

If there is any tendency of the exposed end of the coax section to form corona when the probe is applied at the plate of the 1B3, then use anticorona dope to coat and seal the end of the coax section. Note particularly that this probe, like the high-voltage capacitance-divider probe previously discussed, provides correct waveshapes only when testing horizontal-

frequency waveforms. Vertical-frequency waveforms will be more or less seriously distorted.

Typical test results are illustrated in Fig. 6-11. Although the peak-to-peak voltage is normally in the order of 15 kv at point F, it is also normally very low at point G unless filter capacitor C5 is open. In some receivers, C5 is omitted, and filtering is accomplished by the input capacitance to the high-voltage terminal of the picture tube. But there is appreciable ripple amplitude at point G in these receivers.

Even though the waveform amplitude is normally low at point G, do not make the error of checking ripple voltage with a low-C probe. The DC voltage here is very high and will arc through a low-C probe immediately. Ripple voltage should be checked only with the special high-voltage capacitance-divider probe, advancing the scope sensitivity to maximum, if necessary, in order to obtain adequate deflection.

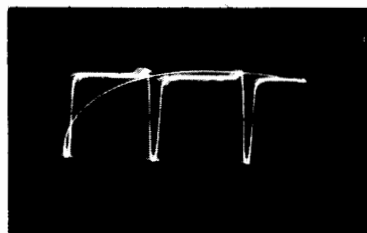

(A) Input too high, but voltage rectifier tube all right.

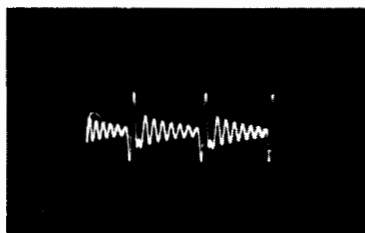

(B) Breakdown in high-voltage winding.

Fig. 6-11. Typical test results.

The waveform at the plate of the horizontal-output tube is normally quite similar to the waveform at the high-voltage rectifier plate, although it is considerably lower in amplitude. More prominent ringing will be observed in many receivers along the baseline of the pulse at point F. The reason for this is that the high-voltage winding of the transformer introduces additional uncoupled (stray) reactance into the high-voltage rectifier circuit.

Fig. 6-2 illustrates the basic principles which are common to all flyback systems, although circuitry details vary considerably from one chassis to another. The end result of all configurations is the same: a peaked-sawtooth (or simple sawtooth) drive voltage to the horizontal-output tube generates a linear sawtooth current flow through the horizontal-deflection coils, and a reasonably smooth DC output from the high-voltage power supply. It is invariably advisable to consult the receiver service data for correct waveshapes and peak-to-peak amplitudes.

## BOOST-VOLTAGE FILTERING

The unfiltered output from a boost-B+ circuit has a high 15,750-cycle ripple. Boost voltage in some receivers is applied to the focusing electrode or the first anode through a filter with a small electrolytic capacitor. If vertical bars or shaded strips appear in the raster, check with the scope to see if the boost line has a high AC ripple. This is sometimes a baffling problem for a beginner. The DC voltage measures correctly, and it does not occur to him that the electrolytic capacitor might be low in value, thus permitting high-level ripple voltage to enter the picture tube.

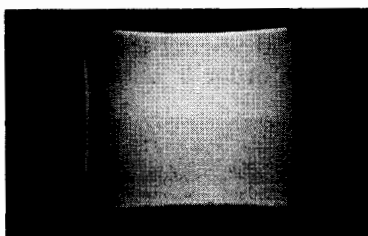

Fig. 6-12. Shaded pincushioned raster.

Few TV receivers are completely free from raster shading. Owners of receivers are usually tolerant of this condition, unless it becomes quite prominent, as seen in Fig. 6-12. The raster has reasonably uniform illumination from top to bottom, but is very noticeably shaded from left to right. The trouble stems, therefore, from the horizontal section in the receiver. Waveform checks at each picture-tube electrode will indicate quickly the point at which the spurious AC voltage is entering. Do not forget the high-voltage power supply. An open high-voltage filter capacitor can introduce sufficient ripple into the second-anode supply voltage to shade the raster.

Pincushioning, evident in Fig. 6-12, is not a waveform-based symptom. It merely indicates that the antipincushion magnets are not properly adjusted, or that a replacement yoke does not match the picture tube (or vice versa). Consult the receiver service data for correct replacement parts and tubes. In the event that a replacement yoke does not match the horizontal-output transformer (or vice versa), the trouble condition *does* show up as waveform distortions and/or incorrect amplitudes. Again, refer to the receiver service data for recommended replacement parts.

## KEYSTONING

Keystoning as seen in Fig. 6-13 is usually caused by defective vertical-deflection coils in the yoke (see chapter on vertical-

sweep troubleshooting), but this is not *always* the case. In some receivers, reliance is placed on a single large electrolytic capacitor in the horizontal section to decouple the horizontal and vertical circuits. When the capacitor is low in value, the heavy sawtooth-current flow in the horizontal circuits modulates the DC supply to the vertical-sweep circuit, causing a keystoneed raster.

In that case, a scope check of the common supply line to the horizontal and vertical sections will show a high-amplitude

Fig. 6-13. Keystoneing is not always caused by yoke trouble.

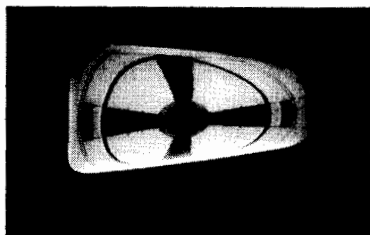

horizontal sawtooth to be present. Again, faulty decoupling can also cause horizontal keystoneing by permitting 60-cycle sawtooth ripple to feed into the horizontal system. This is usually less prominent than the vertical keystoneing.

To summarize, do not make conclusions in troubleshooting the horizontal-sweep section until the key waveforms have been checked. This procedure can often save time as well as needless expense in replacement of normal components.

## CHAPTER 7

# Troubleshooting the Vertical-Sweep Section

The vertical oscillator-and-output section is straightforward, particularly in older-model receivers which utilize separate oscillator and output stages. Modern receivers trend to simplified circuitry in which the two functions are combined, as shown in Fig. 7-1. Interaction of oscillator and output functions results in some added complexities of trouble analysis. If the scope is properly applied, however, operating troubles can be localized with reasonable effort.

### VERTICAL SYNCHRONIZATION

The vertical oscillator cannot lock in sync unless the sync separator supplies a suitable pulse to the integrator. Normal output from the separator is shown in Fig. 7-2A. The prominent pulse in the pattern consists of both the stripped vertical-sync pulse, and a larger "kickback" pulse from the 6EM7. The two pulses can be separated by adjusting the vertical-hold control for a split picture. The vertical-sync pulse then appears as the smaller pulses in Fig. 7-2B. If the picture is rolling because of a defect in the vertical section, the sync pulse rides through the pattern and the scope locks on the larger pulse.

If a normal vertical-sync pulse is not present, attention is turned to the sync separator. But, if the input is normal, proceed to check at the input and output terminals of the integrator. The integrator has substantial input capacitance. Therefore signal passage from point A to point B through the resistive network results in elimination of most of the horizontal sync pulses which were evident in Fig. 7-2. Normal waveforms at the input and output of the integrator unit are shown in Fig. 7-3.

Integration largely eliminates the horizontal pulses, and the vertical pulses are somewhat attenuated also. Because the output of the integrator is coupled to the plate of the first 6EM7 section, the "kickback" pulse is comparatively increased in the waveform. Thus, if the waveform at point C is observed when the picture is split, the vertical-sync pulses have rela-

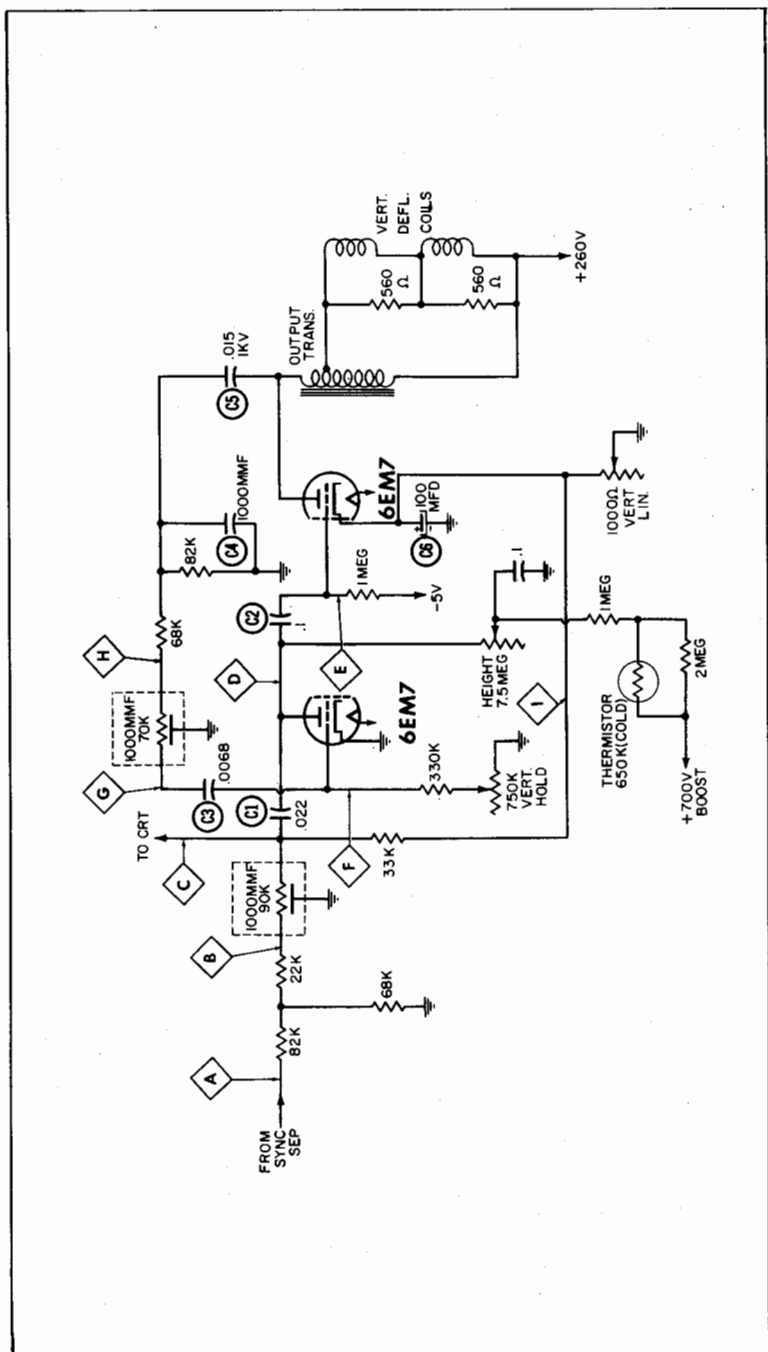
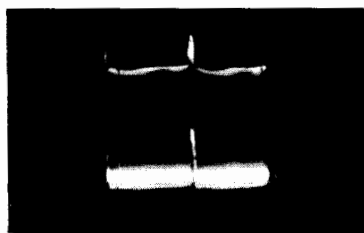

Fig. 7-1. Typical vertical-oscillator and -sweep configuration.



(A) Input waveform at point A.



(B) Change in waveform when picture is split.

Fig. 7-2. Integrator input waveforms.

tively low amplitude, as shown in Fig. 7-4. For the reason that relative pulse amplitudes differ considerably from one circuit configuration to another, *always* check the receiver service data for the particular chassis. No visible “kickback” pulse is found at the output of the integrator in some receivers.

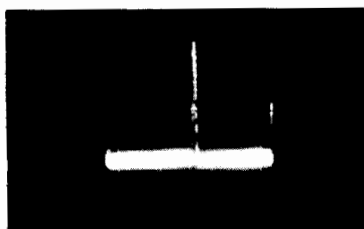

(A) Waveforms at point B.

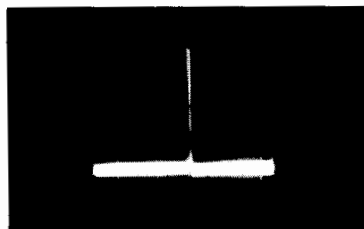

(B) Waveforms at point C.

Fig. 7-3. Normal waveforms at input and output of integrator.

The chief consideration at this point is the presence of a normal vertical-sync pulse and the virtual elimination of horizontal pulses. Otherwise vertical lock is unstable or absent. If integrator defects permit feedthrough of horizontal pulses, interlacing will be poor, and the picture will lack full definition. Note that defects in the oscillatory circuit will reduce the amplitude of the “kickback” pulse, or it may be absent altogether. But this does not affect the amplitude of the vertical-sync pulse. If the sync pulse is not present at point C, look for a shorted capacitor in the integrator assembly. Note



Fig. 7-4. Waveform at point C, when the picture is split.

also that point C is connected to the vertical-blanking network. A shorted capacitor in this network can reduce greatly or kill the sync pulse.

### COUPLING CAPACITOR CHECKS

Even though ample sync is being supplied, defective vertical operation can be caused by defective coupling capacitors. This is a more common cause of off-frequency operation or unstable lock than are defective resistors. C1 and C2 are immediately



Fig. 7-5. Normal waveform at point D.



Fig. 7-6. Distorted waveform at point D when capacitor C1 is low in value.

suspected if a normal waveform (Fig. 7-5) is not observed at point D in Fig. 7-1. The coupling capacitors should be tested first for leakage on a capacitor checker, at rated working voltage. If the leakage resistance is very high (note that the capacitors must operate in a high-resistance circuit), check next to see whether either of the capacitors are open, or have lost substantial capacitance. If a capacitor checker is not available, make a substitution test.

If C1 is low in value, the picture becomes nonlinear vertically. Also, the waveform at point D becomes distorted as seen in Fig. 7-6. The waveform amplitude increases, because the integrator network loads the oscillator to a lesser extent. Similarly, in the event that C2 is low in value, the normal waveform at point E becomes distorted, as shown in Fig. 7-7. If the coupling capacitors are found to be all right, do not leave this branch of the circuit until the height control is checked



(A) Normal waveform at point E.



(B) C2 low in value.

Fig. 7-7. Defects in C2 affect wave shape.



out. It can become worn, with resulting change in resistance value and stability of adjustment. In particular, if the oscillator operates normally for a length of time, following which the oscillator "pulls" excessively and breaks vertical lock, an unstable height control should be suspected.

A defective height control can be simulated falsely in some cases by a defective thermistor (650-K cold resistance shown in Fig. 7-1). Thermistors have a tendency to increase in value after an extended service period. The function of the thermistor is to maintain constant vertical height with usual variations of supply voltage due to line-voltage fluctuation. But if this branch of the circuitry checks out satisfactorily, turn your attention to the feedback branch of the oscillator.

### FEEDBACK WAVEFORMS

The normal waveform for this circuit at point F is shown in Fig. 7-8. If distorted, or low in amplitude, check the waveform also at point G. The normal waveform is shown in Fig. 7-9A. A typical distorted waveform which results when C3

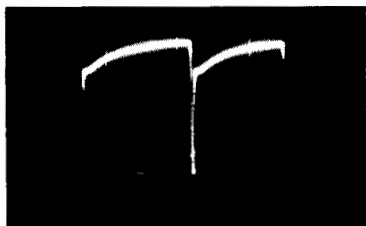

Fig. 7-8. Normal waveform at point F.

is low in value is shown in Fig. 7-9B. The vertical oscillator speeds up, and the picture cannot be locked. The increased oscillator frequency causes additional cycles to appear in the pattern, when the scope is deflected at a 30-cycle rate. Leakage in C3 has much the same effect as capacitance loss, because the negative DC grid bias is bled to ground.

A defect in the vertical-hold control can simulate leakage in C3, but is a less common cause of trouble. An ohmmeter check should indicate rated resistance value, without any rough spots as the control is turned through its range. When the foregoing components are cleared from suspicion, make a waveform check at point H. The waveform appears normally as in Fig. 7-10. Incorrect shape and/or amplitude indicates a faulty component in the couplate unit, or the components between point H and the output transformer. Each should be checked out in turn.

It is generally undesirable to check waveforms at the plate of the output-tube section, or in its near vicinity. The ampli-



(A) Normal waveform.



(B) C3 low in value.

Fig. 7-9. Normal and abnormal waveforms at point G.

tudes are comparatively high, and a low-C probe can be damaged. Note that C5 is a 1-kv capacitor. It cannot be checked properly on an ordinary capacitor tester, and a substitution test is advised. C4 is a conventional capacitor. If open, however, the pulse voltage across the 82-K resistor rises excessively, due to loss of capacitor-divider action.

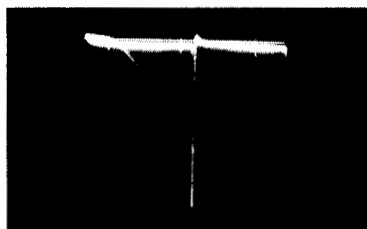

Fig. 7-10. Normal waveform at point H.

### VERTICAL-OUTPUT TRANSFORMER

Troubles in the vertical-output transformer may or may not be readily apparent. If there is a breakdown between layers or from winding to core, arcing occurs. This is often audible, and in any event, the picture fluctuates erratically in height. Again, a short between turns or leakage between layers produces a steady trouble symptom in that the picture lacks height. Note carefully the difference in symptoms between shorts in the transformer, and shorts in the yoke; the former reduces picture height, while the latter causes keystoneing. Thus, yoke faults are more easily localized.

A good confirming test for shorted turns in the output transformer can be made with a square-wave generator. The receiver is turned off, and a square-wave generator is connected as shown in Fig. 7-11. No circuit disconnections are required. The inductance of the output circuit normally distorts a 10-kc square wave as seen in Fig. 7-12. The long curved portion of the waveform is an indicator of the circuit inductance with respect to the circuit resistance. Shorted turns absorb energy,

and not only reduce the inductance, but also introduce an effective AC resistance. Hence, shorted turns cause a marked change in the square-wave response, as illustrated in Fig. 7-12.

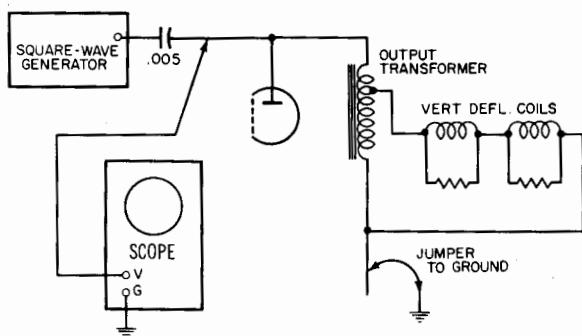
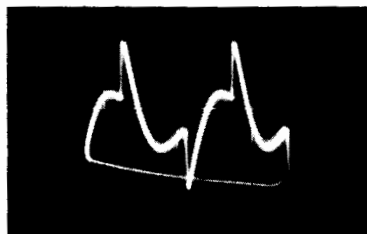
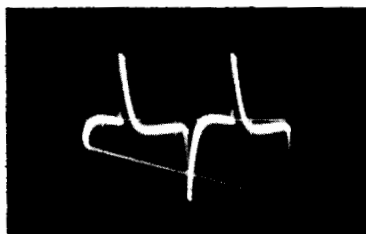

Fig. 7-11. Test setup for shorted turns.

To summarize, the square-wave test is made *after* it has been determined that reduced picture height is not due to faulty capacitors or resistors, and after you are certain that the vertical height does not fluctuate and that audible arcing is not occurring. If audible arcing is occurring, however, the output transformer is replaced without making any further tests in the circuit.



(A) Normal 10-kc square-wave response.



(B) Shorted turns in output transformer.

Fig. 7-12. Results of shorted-turns test.

### CATHODE CIRCUIT

The normal cathode-circuit waveform is checked at point I and appears as illustrated in Fig. 7-13. The usual troublemaker here is 100-mfd electrolytic capacitor C6. As the capacitor ages, it tends to lose capacitance. Also, the picture becomes so nonlinear that the vertical-linearity control must be turned to the end of its range. A waveform check then quickly shows the deficiency, as in Fig. 7-13. It might be supposed that the fine structure of the waveform would become more prominent when

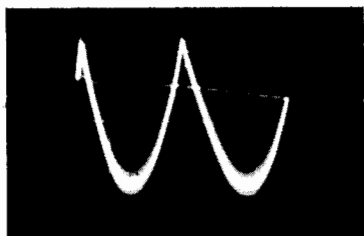

(A) Normal waveform at point I.

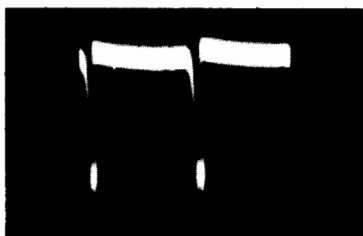

(B) C6 low in value.

Fig. 7-13. Cathode-circuit waveforms.

C6 loses capacitance, but the opposite is true. The reason for this is that the 60-cycle component increases rapidly in amplitude compared with the horizontal crosstalk which is picked up.

If C6 has merely lost capacitance, a bridging test with a good electrolytic unit will restore normal operation. However, if the trouble is due primarily to leakage, a bridging test may be inconclusive. In that case, C6 should be checked at its working voltage on a capacitor tester, or a substitution test should be made. Overlooking the possibility of faulty electrolytics is one of the commonest errors made by beginners.

### VERTICAL-BLANKING NETWORK

Most present-day receivers have vertical-blanking networks, to cut off the picture tube during vertical-retrace time. Blanking should not be required, in theory. But it is desirable in practice because viewers sometimes operate the picture tube at higher brilliance than normal, and this makes the blanking pedestals in the video signal inadequate to their task. Also, not all receivers have DC-coupled video amplifiers. This situation intensifies the problems of retrace visibility. When an AC-coupled video amplifier is used, the operating point of the picture tube shifts with changing background brightness in the

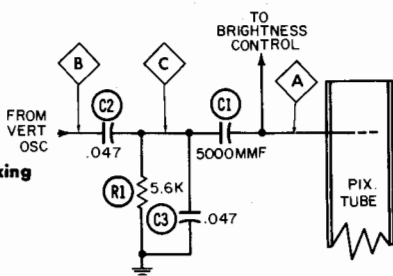
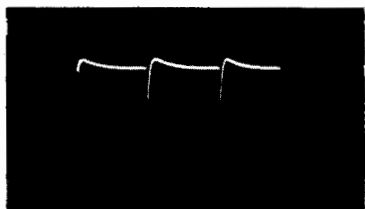

Fig. 7-14. Vertical-retrace blanking circuit.

DC GRID VOLTAGE REMAINS THE SAME, WHETHER C1 IS OPEN OR NORMAL.

televised scene. As a result, retrace lines which do not appear in light backgrounds become evident in darker backgrounds.

Again, as a picture tube weakens, the viewer automatically turns up the brightness control to compensate for lower screen output. This shifts the picture-tube operating point abnormally, and brings up the visibility of vertical-retrace lines. These considerations weigh in favor of vertical-blanking networks, as shown in Fig. 7-14. A scope provides an easy method of closing in on circuit faults. Check first the output at point A. The blanking-pulse amplitude should be sufficient to cut off the picture tube, and this peak-to-peak voltage is usually specified



(A) Waveform when C is normal.

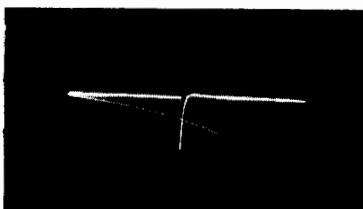

(B) Distorted (weakened) waveform when C is low in capacitance.



(C) Very weak indication when C is open.

Fig. 7-15. Waveforms at A of Fig. 7-14.

in the receiver service data. If coupling capacitor C1 is open or low in value, the waveform amplitude is subnormal, as illustrated in Fig. 7-15. In case C1 is open, the normal waveform is found, of course, at the input end of C1, at point C.

The normal waveform at point B is shown in Fig. 7-16. If the vertical-sweep section is operating normally otherwise, absence or distortion of this waveform is the result only of a poor connection to the input blanking network. With a normal waveform at point B, check next at point C, to determine whether C2 is open. Note that leakage in C2 makes it impossible to lock the picture vertically.

R1 and C3 serve two functions. In combination with C2, this is a waveshaping network which changes the peaked-sawtooth input into a pulse output for proper blanking action. Thus, if C3 is open, a distorted peaked-sawtooth wave is applied to the

grid of the picture tube, and proper blanking action does not occur. The blanking action, however, is very uneven and part of the picture is dimmed or blanked out completely. The blanking network has also a voltage-divider action which prevents excessive peak voltage from being applied to the picture-tube grid. Although capacitor trouble is first to be suspected, be sure to check R1 if necessary.

**Fig. 7-16. Input waveform to the vertical-blanking network.**



The principles established in the foregoing discussion apply to all of the numerous variations encountered in vertical-section circuitry. Keep in mind the basic circuit action, and always refer to the receiver service data when making waveform analyses.

## CHAPTER 8

# Signal-Tracing the Sound and Audio Section

A simple intercarrier sound system is diagrammed in Fig. 8-1. Some TV receivers have more stages, including a 4.5-mc IF amplifier preceding the limiter, and an audio driver following the sound detector. A ratio detector, or sometimes a discriminator, is used instead of a gated-beam detector. The basic signal processing occurs in all cases in this order: 4.5-mc amplification, partial or full limiting, FM detection, and audio amplification.

The sound take-off coil (or transformer) may be connected at the video-amplifier output, or the picture-detector output. Sometimes the sound take-off transformer does double duty as a 4.5-mc trap in the video amplifier. You may find an occasional receiver in which the output from the last IF stage branches into a limiter. The 4.5-mc signal is generated by heterodyning in the limiter instead of the picture detector. Again, you may rarely find a slope detector following the limiter. In some receivers, the audio-output stage does double duty as a B+ voltage divider.

### TEST SIGNAL FOR THE INTERCARRIER SECTION

If a modulated 4.5-mc sound signal from an AM generator is applied through a small blocking capacitor to the sound take-off point, you can usually signal-trace the entire sound section. Offhand, this might seem to be impossible, because the limiter stage normally rejects amplitude modulation. On the other hand, most AM generators have appreciable *incidental FM*, particularly when set for high-percentage modulation as illustrated in the following pages. Incidental FM makes it possible for the generator to do double duty in testing the sound section.

Signal tracing in the sound section should be done with a wide-band scope and a low-capacitance probe. There are two reasons: There is no AM component in the output of a normally operating limiter (or at least negligible AM signal), and hence a demodulator probe gives no indication, when used with an

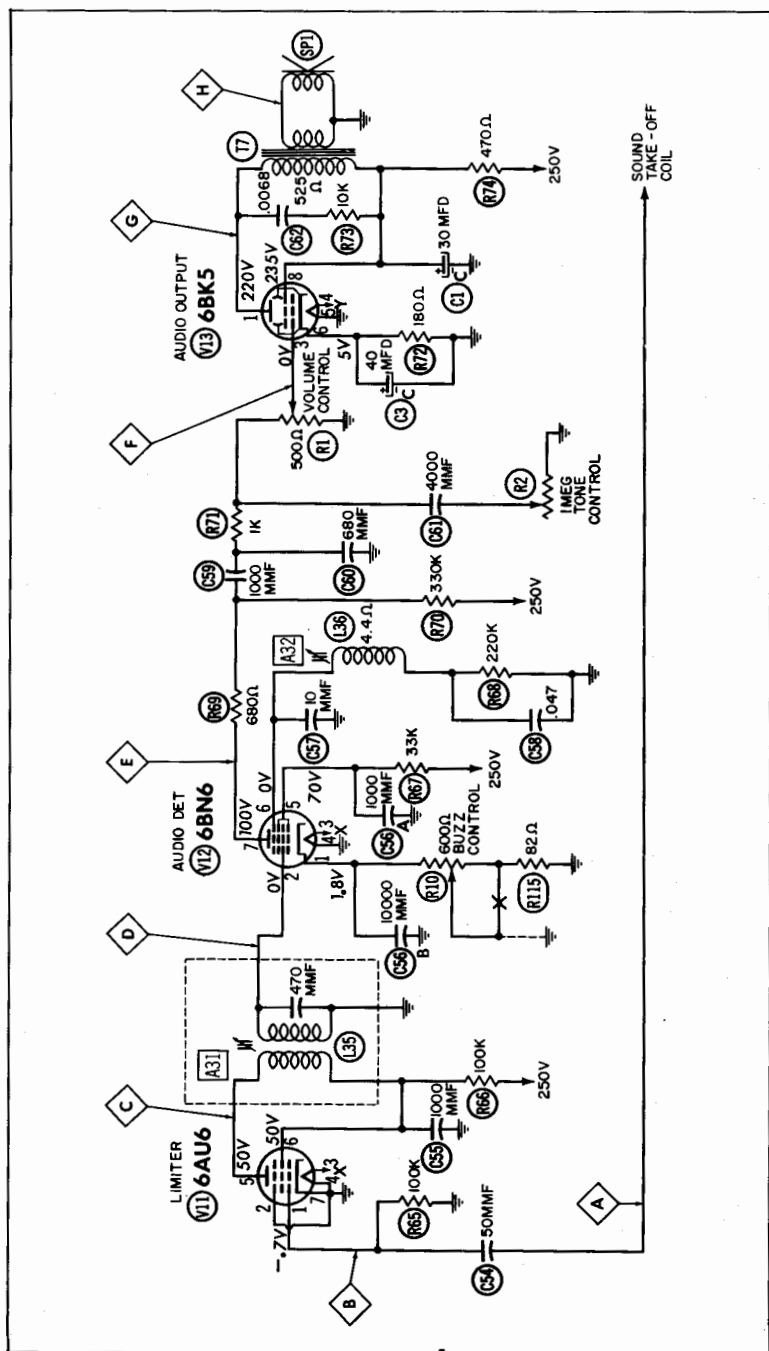

Fig. 8-1. A simple sound-section configuration.



AC scope. The other reason is that a demodulator probe has comparatively low input impedance, and disturbs the narrow-banded FM circuits excessively. Comparatively, a low-C probe imposes less loading and detunes the circuits less.

The scope should have good response at 4.5-mc. Otherwise the signal under test will be attenuated accordingly in the scope amplifier. If the AM signal is found at points A and B in Fig. 8-1, the sound-takeoff circuit up to the grid of the limiter is working. At point C the signal may have less *apparent* amplitude modulation. If the limiting action is complete, you will see

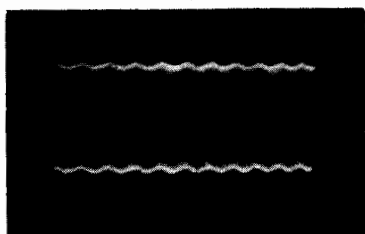

Fig. 8-2. Apparent AM limiter output, due to incidental FM.

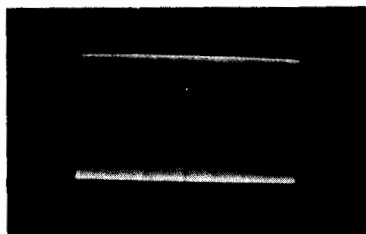

Fig. 8-3. Saturated limiter output, no incidental FM in test signal.

a modulation envelope corresponding only to the incidental FM in the test signal (Fig. 8-2). In general, the modulation depth will be less than that of the combined AM and FM seen at the limiter grid. If the AM generator has no incidental FM, the output from a saturated limiter has no modulation envelope (Fig. 8-3).

Fig. 8-4 depicts a configuration using a sound-IF amplifier operating in Class A to drive the limiter. Amplitude modulation is reproduced at points A and B, but not at point C, if the

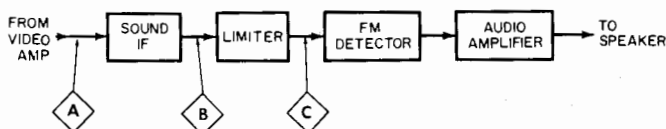
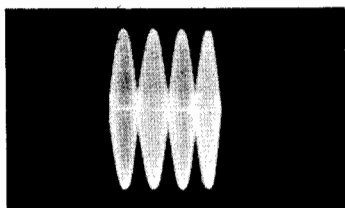

Fig. 8-4. Normally tuned IF circuits may change the waveform.

limiter is saturated. However, the waveform can appear quite different at point B than at point C, when there is incidental FM in the AM test signal. The FM component "sweeps" the sound-IF tuned circuits and adds a partial "response curve" to the AM envelope.

This situation is illustrated in Fig. 8-5, which shows a display of the output from a fully modulated AM generator, compared with the display after passing through a tuned Class-A ampli-

fier. The input waveform has considerable incidental FM because of 100% modulation. Or, the output consists of a mixture of amplitude modulation and an FM "sweep" signal. Various parts of the AM envelope can be increased or cancelled, depending upon the shape of the FM envelope. The latter varies as the generator is tuned slightly higher or lower in frequency. In Fig. 8-5, there is a cancellation as the troughs are entered, making the amplifier output appear as if the test signal were overmodulated.



(A) Output waveform from AM generator.

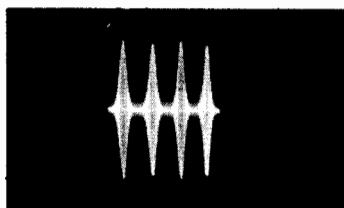

(B) Output from receiver IF amplifier, showing distortion by incidental FM.

Fig. 8-5. Incidental FM from modulated oscillator is maximum at 100% modulation.

Another typical condition of incidental FM distortion is seen in Fig. 8-6. Here, AM modulation is nearly 100%, and there is considerable incidental FM in the output. The amplifier output appears with a "flat-topped" envelope at one setting of the generator tuning dial. The envelope changes shape as the generator is tuned through the IF passband, but the amplifier output never matches the generator output.

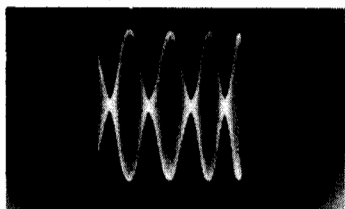

(A) Generator output.

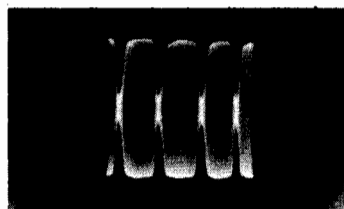

(B) Amplifier output.

Fig. 8-6. Another typical example of incidental FM distortion.

Incidental FM is reduced when the AM generator is set for a comparatively low percentage modulation. This is evidenced by less change in envelope shape as the generator is tuned through the sound-IF passband. A few service-type AM generators have negligible incidental FM, and practically no change in envelope is observed as the generator is tuned through the IF band. The generator output has the same waveform as the output from the driven Class-A amplifier. The waveform of the generator output

is not necessarily a sine wave, as beginners often suppose. A scope test may show that a sine waveform is approached at some frequencies, or bands, but departs widely from a sine shape on other bands, or at different points on the same band. The illustrations in Fig. 8-7 are typical of one service-type generator.



Fig. 8-7. Distorted outputs from an AM generator.

It is not necessary that an AM generator have a good waveform. Signal tracing can be accomplished and stage-gain measurements can be made regardless of waveform. It is only necessary to distinguish between distortion present in the generator output, and distortion which may be introduced by the sound circuits. When test work is started, it is advisable to connect the generator output cable directly to the scope's vertical-input terminals, to determine the waveform which is

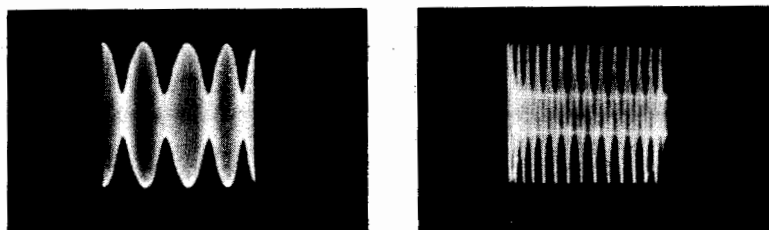

(A) Low deflection rate.

(B) High deflection rate.

Fig. 8-8. Effect of scope deflection rate on waveform aspect.

to be used at the given frequency. At this time, check also the percentage modulation. About 30% modulation is suitable for sound-section tests. Most AM generators have adjustable modulation depth.

The generator modulating frequency is usually about 400 cycles. Thus, if the scope is deflected horizontally at a 100-

cycle rate, four modulation peaks will appear in the pattern, as seen in Fig. 8-8. If the deflection rate is increased to about 300 kc, the carrier peaks become the prominent feature in the pattern. For the types of tests described in this chapter, the 100-cycle deflection rate is preferred.

### MINIMIZING CIRCUIT LOADING

As shown in Fig. 8-9, the generator output should be applied at the grid of the video-amplifier tube. If the signal is applied in the plate circuit at the actual take-off point, the 4.5-mc transformer will be detuned. Use a small blocking capacitor in series with the "hot" lead from the generator. This avoids possible drain-off of bias voltage in a grid circuit, and possible damage to generator and receiver in a plate circuit.

Turning to the scope, a low-capacitance probe has enough input capacitance to detune many sound-IF circuits substantially. If the signal level is fairly high, you can clip the probe around the insulation of the grid or plate lead of a sound-IF tube. Otherwise, use a small trimmer capacitor for a scope probe, and reduce the capacitance to the smallest value that permits adequate deflection.

### LIMITER CHARACTERISTICS

A low-level output from the generator does not drive the limiter into saturation, and amplitude modulation is *not* rejected, accordingly. This condition is analogous to weak-signal reception which may be noisy because the low-level inter-carrier signal is below the limiter saturation point. As a rough rule of thumb, a .1-volt 4.5-mc signal injected at the output of the picture detector is normally expected to saturate the limiter. Proper limiter action depends upon correct DC supply voltages to the limiter tube, and upon good capacitors and resistors in the circuitry.

The same signal which is found at point C in Fig. 8-1 should also appear at point D. Otherwise the sound-IF transformer is defective or misaligned. An audio-frequency signal is normally present at points E through H. If not, check the DC voltages and resistances in the associated circuit. Also, if necessary to close in on the defective component, check capacitors on a capacitor tester, or by substitution. Resistance checks can be made on coils, although this shows little aside from continuity. If a coil does not tune satisfactorily, a substitution test is preferred.

Electrolytic capacitors, if present, must be checked. Leakage or loss of capacitance can cause weak or distorted output, or

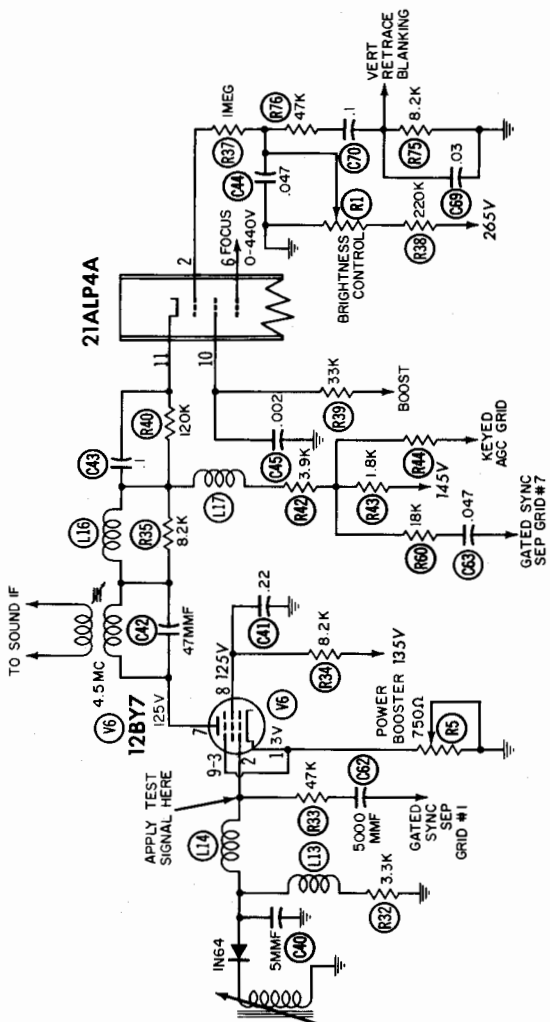

Fig. 8-9. Apply test signal at grid—not at plate.

both. Although numerous variations of sound-section circuitry are used in different chassis, the general principles are the same in all. It is necessary in each case to consult the receiver service data for specified voltages, resistances, and component values.

Inability of the limiter to eliminate amplitude modulation is one of the causes of sync buzz. Buzz modulation is generated in the IF amplifier, video amplifier, or both. If the modulation depth is excessive, audible buzz will be present, regardless of limiter efficiency. It is assumed here, however, that the IF and video amplifiers are operating properly, and that only a normal amount of buzz modulation is to be contended with by the limiter.

The most severe demand is placed on the limiter stage when it is followed by a discriminator, because a discriminator has no inherent rejection of amplitude modulation. Hence, if you should be servicing a buzz complaint on a receiver of this type (they are in the minority, however), make a careful check of the limiter action. Up to 50% amplitude modulation should be completely "wiped off" both top and bottom of the test signal. This does require an AM generator with very little incidental FM, because an adequate limiter stage will otherwise appear to be defective.

Less severe requirements are imposed on the limiter by a ratio detector, because this configuration inherently can reject up to 30% amplitude modulation, if operating normally. Ratio detectors should be preceded however with at least partial limiting, because misadjustment of the fine-tuning control or too high setting of the contrast control can otherwise lead to audible buzz and cause customer dissatisfaction. Again, if the ratio-detector alignment should drift slightly, partial limiting will assist in suppressing sync buzz. A limiter becomes more effective as the plate and screen voltages are reduced (tube saturates earlier), but the peak-to-peak voltage output is reduced accordingly. A compromise between output level and limiting action is commonly made by the manufacturer.

Signal-tracing the audio section will quickly show where the signal is stopped or substantially attenuated. The scope is the most useful instrument to find where a signal is being distorted. The most common cause of distorted sound is clipping, illustrated in Fig. 8-10. Clipping can result from low plate or screen supply voltages, or incorrect grid (or cathode) bias. The latter commonly results from a shorted cathode-bypass capacitor, or from a leaky grid-coupling capacitor. Leaky screen or decoupling capacitors can reduce the screen or plate supply voltage. Less commonly, resistors in the audio circuit increase in value and cause clipping distortion.

Because of the arbitrary waveform which results from incidental frequency modulation of an AM generator, technicians can make more meaningful tests of the audio section by in-

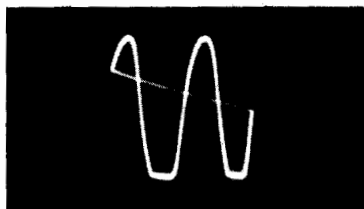

Fig. 8-10. Negative peak clipping of the audio signal.

jecting an audio-frequency signal into the volume control. If an audio oscillator is not available, it is important to note that most signal generators have an AF output, as seen in Fig. 8-11.



Fig. 8-11. Most signal generators have an audio-frequency output.

This is a fixed-frequency output (usually about 400 cycles), which serves adequately for most troubleshooting requirements.

## CHAPTER 9

# Troubleshooting Power Supplies

Power supplies and their associated circuitry are the source of various obscure trouble symptoms that can cause excessive waste of time in random hit-or-miss approaches. Poor sync action, raster shadowing, loss of interlacing, and audio interference in the picture are typical of these trouble symptoms. DC voltage measurements seldom provide useful clues, because the basic difficulty is AC contamination of the DC supply voltages. Hence, a scope can be a valuable time-saver in localizing power-supply troubles.

### STACKED B+ CONFIGURATION

Many modern receivers use a stacked B+ section in the power-supply system, as shown in Fig. 9-1. The audio-output tube doubles as a B+ voltage divider, in order to reduce manu-

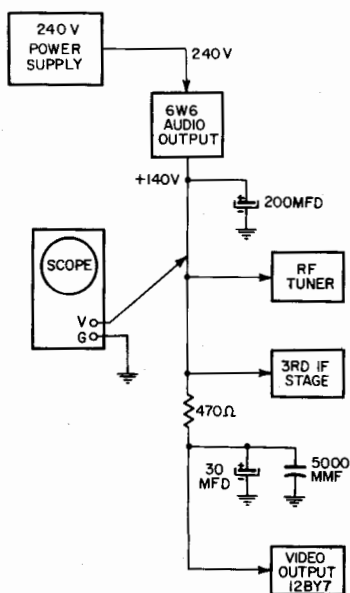

Fig. 9-1. Audio-output tube is also used as a B+ voltage divider.



facturing costs. The normal ripple waveform at the audio-output cathode is shown in Fig. 9-2A. Obscure symptoms can arise if the 200-mfd filter capacitor becomes low in value (Fig. 9-2B). The DC supply voltages remain about the same, but sound modulation appears in the picture and sync action becomes unstable. A scope check at the output of the 240-volt power supply may show a ripple voltage below the maximum amplitude specified in the receiver service data. But, a check across the 200-mfd filter capacitor immediately reveals the trouble.

When an audio-output tube is used as a voltage divider, the B+ voltage must be filtered once again in the circuit following the cathode of the tube. The reason is that the DC supply voltage becomes contaminated with audio signal through the output tube. This initial filtering is done, in Fig. 9-1, by the

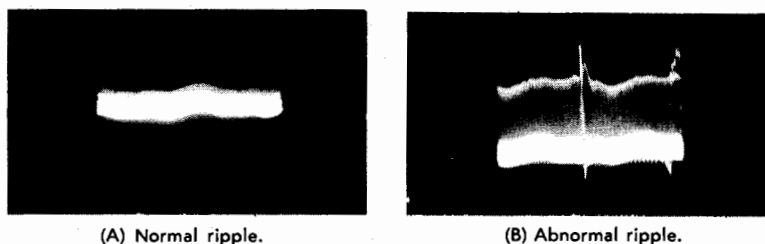

Fig. 9-2. Ripple wave at cathode of audio-output tube when 200-mfd bypass capacitor is faulty.

200-mfd capacitor, and is followed by a second filter section which supplies the video-output tube. The latter section not only provides a smooth DC supply to the video section, but also serves to decouple the video amplifier from the IF and RF sections. Note that the 30-mfd capacitor is shunted by a 5,000-mmf capacitor. The purpose of the small capacitor is to provide a low-impedance bypass to ground for high-frequency AC voltages. Large electrolytic capacitors often have appreciable inductance, which lessens their effectiveness in high-frequency circuits.

### INPUT WAVEFORM TO FILTER

A typical transformer power-supply circuit is shown in Fig. 9-3. The input waveform to the filter is checked at point A. It might be supposed that this waveform would be the same in all receivers, but this is not the case. Depending upon the number of sections in the filter, use of inductors or resistors between sections, and current drain from the different sections, this input waveform varies. Two common examples are illustrated in Fig. 9-4.

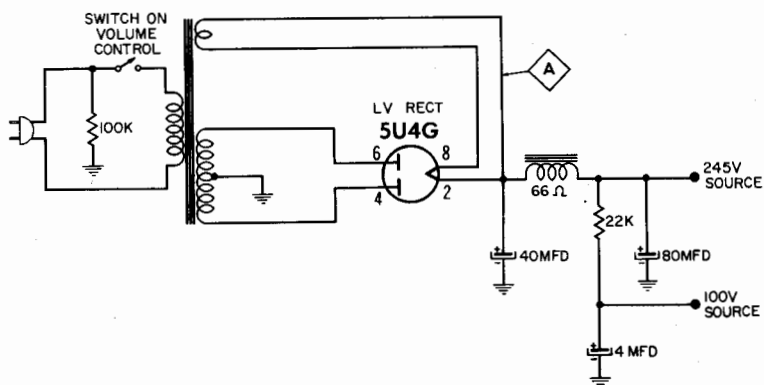

Fig. 9-3. A transformer-type power supply.

The input waveform approximates a sawtooth when the input impedance of the filter is essentially capacitive, due to appreciable resistive isolation between sections. The sawtooth waveform is generated because the rectifier conducts in pulses (it is back-biased by the B+ voltage), and the input filter ca-



Fig. 9-4. Typical waveforms at filter input.

pacitor is suddenly charged by each pulse. The capacitor discharges exponentially between pulses, and supplies DC current to the filter sections following. The nature of this pulse-charging sequence is seen in Fig. 9-5. This is the current flow in a transformerless-type receiver. The waveform shows both the heater and filter current in the line. The heater current is a sine wave,

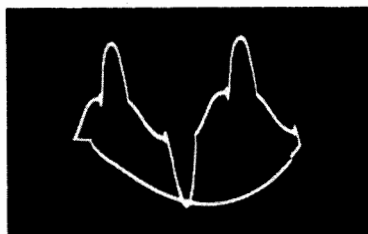

Fig. 9-5. Filter draws pulses of current from the rectifier.

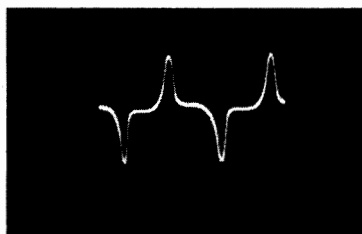

Fig. 9-6. Pulse-current flow without a sine-wave component.

and superimposed with the pulse current drawn by the rectifiers. A pulse current waveform by itself is shown in Fig. 9-6.

In the Fig. 9-3 configuration, a filter choke is connected between the sections. A choke normally has appreciable inductance and comparatively low resistance. The inductive reactance modifies the input voltage wave, as seen in the right photo of Fig. 9-4. Depending upon inductance and capacitance values and current drain, the waveform may also be unsymmetrical (tilted), as seen in Fig. 9-7. In any event, the essential point

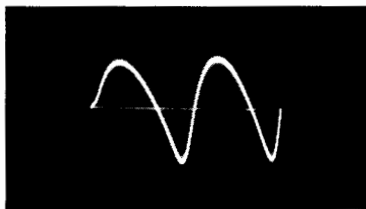

Fig. 9-7. Unsymmetrical waveform at input of the filter.

is that the power supply has normal operating waveforms (and amplitudes) which are characteristic of its configuration and demand. These characteristics can be checked in the receiver service data, or by comparison with the waveforms in a similar chassis. If a component is defective, or if a branch current is not normal, waveshapes and amplitudes change to a greater or lesser extent, depending upon the severity of the trouble condition.



Fig. 9-8. Alternate peaks of the signal have different heights.

### INCIDENTAL BYPASSING FUNCTION

Power-supply waveforms generally contain details which reflect circuit action in various receiver sections (Fig. 9-7). In older receivers or elaborate modern receivers, extensive filtering is provided, which results in "clean" input waveforms. Waveforms across output filter capacitors, on the other hand, are generally contaminated with residues from the sweep circuits in particular, and sometimes from other circuits as well. Economy-type receivers display appreciable contamination of the input waveform also, because of simplified power-supply circuitry.

Both horizontal and vertical sweep residues are prominent in the Fig. 9-8 waveform. The residues appear because the sweep circuits are not decoupled individually from the power supply, in which the filter capacitors are also serving a decoupling function. Because their bypassing action is somewhat incomplete, the sweep residues appear in the power-supply waveform. The horizontal-sweep residue is seen as a "picket-fence" interference in the main waveform. The vertical-sweep residue appears as different heights of alternate peaks.

The vertical-output stage has a comparatively heavy current demand, and operates at 60 cycles. The full-wave rectifier, however, generates a 120-cycle ripple. Therefore, the vertical sweep-current demand is imposed on every other peak of the ripple waveform. A power supply like any voltage source, has a certain source impedance, and when current demand rises, the voltage output drops. The lower the source impedance, the better the regulation, and the less the amplitude variation on alternate ripple peaks. The essential point here is that the ratio of peak amplitudes is an indicator of the power-supply regulation, and this is duly noted by the experienced technician. Poor regulation can result from loss of filter capacitance, poor power factor, high forward resistance in contact rectifiers, or defective filter chokes.

In a voltage-doubler or half-wave power supply, the ripple frequency is 60 cycles and the vertical sweep-current demand occurs on each peak of the ripple waveform. Thus, if the receiver is tuned to a local TV station, the vertical-sweep residue is effectively masked by the ripple waveform. Again, if the receiver is tuned to a distant station, or if a conventional pattern generator is used, the vertical-sweep residue "snakes" through the ripple waveform, and its amplitude is plainly evident. The reason for this is that power companies in remote areas do not have exactly the same frequency as the local power company, and ordinary pattern generators do not have the vertical-sweep oscillator locked to the power-line frequency. Again, if the receiver is tuned to a local station, the vertical-sweep residue will "snake" through the ripple waveform if the vertical-hold control is misadjusted to make the picture roll.

### **CURRENT WAVEFORMS**

A DC meter can be connected in series with any branch of the power-supply circuit, but it shows only the value of the DC current component. This information can be useful on occasion, however. The AC current, which is of primary concern in troubleshooting procedures, can be checked properly only with a scope. Note that an AC meter reads inaccurately

because of the waveform error (power-supply waveforms are not sine waves), unless a peak-to-peak meter is used. The latter will show the true amplitude of the AC waveform. In the final analysis, a scope is the most satisfactory indicator of current waveforms.

Service checks of current waveforms are commonly hampered by the necessity for inserting a small resistance in series with the circuit under test, and connecting the scope across the resistor. There are exceptions, of course. For example, if a scope is connected across the 470-ohm resistor in Fig. 9-1 (which is already in the circuit), the current in this supply line is displayed. If a filter resistor is between two filter capacitors, the scope can be connected across the filter resistor to display the current in this part of the circuit. Some receivers have a fuse resistor which makes a convenient current-waveform test point.

Inasmuch as current waveforms are generally unspecified, technicians make use of comparison tests in similar chassis. Comparison tests can localize a defective component quickly. Remember that ordinary scopes operate with a "hot" case when such tests are made, and therefore use caution to avoid a shock! Incidentally, it is interesting to note here that AC probes are now available for scopes, but they are expensive. Such AC probes are very convenient, because no connection is required to the circuit under test. The probe is merely clamped around the lead, and the current waveform appears on the scope screen. Current probes are calibrated, so that peak-to-peak currents can be read from the scope pattern. A current probe, of course, leaves the scope case "cold." It permits quick and accurate test of the AC being drawn by each circuit branch. If used with a DC scope, it also shows the value of DC being drawn by each branch.

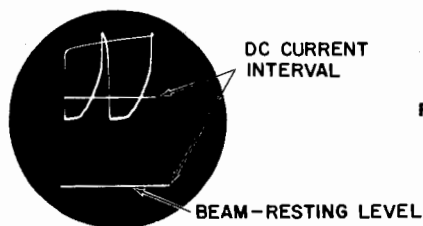

Fig. 9-9. AC and DC current indication.

The characteristics of current indication by a DC scope are shown in Fig. 9-9. The AC waveform rises above the beam-resting level by an amount which shows the value of DC present. The amplitudes of the AC and DC waveforms are measured in peak-to-peak volts. That is, DC and peak-to-peak volts have equal units on a calibrated scope.

## "ABOVE-GROUND" TEST METHODS

Just as current waveforms can be checked effortlessly in any circuit branch when a current probe is used, modern methods are available for checking voltage waveforms in any circuit without difficulty. As a simple example, consider again the test illustrated in Fig. 9-10. The scope displays the voltage waveform across the resistor. This waveform is, of course, identical with the current in the lead from the first to the second filter capacitor. The "hot" scope case is a possible source of shock to the operator, and is the outstanding difficulty here

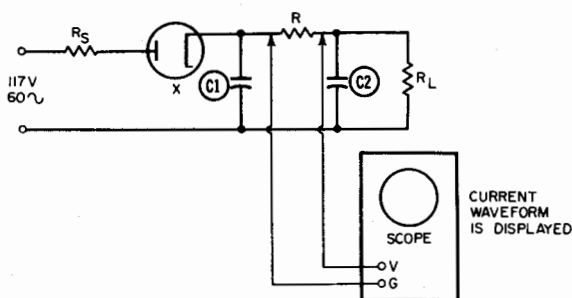
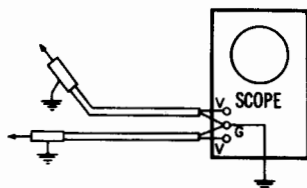

Fig. 9-10. Scope case is "hot" in this above-ground test.

Several service-type scopes are designed to eliminate this difficulty by providing a balanced input to the vertical amplifier in the scope. (Balanced input is also called push-pull input, double-ended input, or differential input.) Fig. 9-11 shows how this type of scope has two vertical-input terminals, and a ground terminal. The ground terminal is usually connected to the chassis of the receiver under test, or it may be left un-

Fig. 9-11. Balanced vertical input.



connected if the scope is well designed. The two vertical-input leads are used in exactly the same manner as the single vertical lead and ground lead of an ordinary scope. The chief advantage of this method is that the two vertical-input leads can be connected across any power-supply component without making the scope case hot. The case is always at ground potential.

Balanced input is obtained by simple circuitry, as shown in Fig. 9-12. Nearly all present-day scopes use paraphase vertical amplifiers. These are push-pull amplifiers with a common cathode resistor. In an ordinary scope, the grid of one tube is grounded, as shown in Fig. 9-12A. However, the grids of both

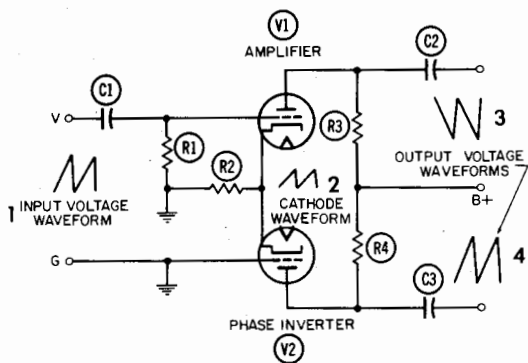

(A) Ordinary input.

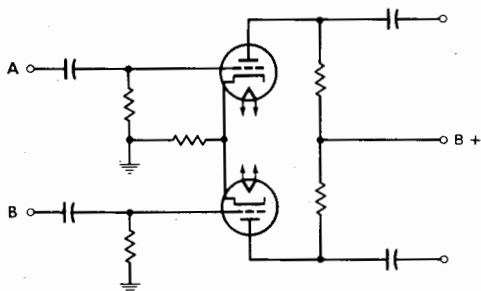

(B) Balanced input.

Fig. 9-12. Input circuits.

tubes are driven in a scope with balanced input, as seen in Fig. 9-12B. Either input A or B can be used as a "hot" lead and the other as a ground lead, or both inputs A and B can be used as "hot" leads in above-ground tests. This latter use is quite important. Thus, if a scope has balanced input, all the tests which are possible with an ordinary scope can be made, plus above-ground tests which are difficult with ordinary scopes.

## CHAPTER 10

# Radio-Receiver Troubleshooting

Signal-tracing is one of the principal troubleshooting methods used in radio-receiver servicing. Although ordinary signal tracers are quite useful, they fall far short of the oscilloscope's information capability. A scope is the best radio signal tracer, because it gives both distortion data and exact amplitude measurements. Scope patterns show where distortion originates, and indicate the type of distortion present, which, in turn, helps to pinpoint the defective component. Accurate gain measurements can also be made, and these measurements cannot be approximated by an ordinary signal tracer.

Only AM-receiver troubleshooting is covered in this chapter. Techniques applying to FM receivers are basically the same as those discussed in the chapter on sound sections of TV receivers. Test signals for AM radio troubleshooting should be supplied by an AM generator. Broadcast signals are difficult to work with because of their transient characteristics. Even a grid-dip meter is a more satisfactory signal source than a broadcast antenna.

### SCOPE REQUIREMENTS

Conventional AM chassis can be serviced with any scope which is adequate for black-and-white TV work. The highest signal frequency of interest is 1.5 mc. A simple high-frequency probe must be used with the scope in order to avoid objectionable circuit loading and detuning. The configuration shown in Fig. 10-1 meets these requirements.

A tubular ceramic trimmer capacitor is convenient in making up a shop-constructed probe. The head is clipped from the adjusting screw, which is ground to a probe point. The unit is then placed in a small housing as shown, and connected to the coax input cable to the scope. Be sure to include the housing to shield the exposed surface of the trimmer. Otherwise, pick-up of stray fields will be excessive, and tests in low-level circuits will be impractical. The adjusting screw should be turned out



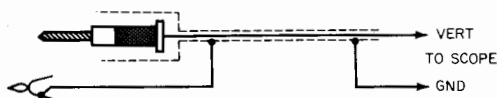

Fig. 10-1. Tubular-ceramic trimmer capacitor serves as a high-frequency probe.

as far as possible, while permitting adequate deflection on the scope screen. This insures that the circuit under test will not be loaded too much. In low-level circuits, the trimmer must be adjusted for a higher capacitance value.

Calibration is not often required, but is easily made when the occasion arises. The probe should be calibrated at the frequency of interest, such as 455 kc, or other test value. To calibrate, use a signal generator or another receiver which is operating normally. A peak-to-peak reading VTVM is used to measure the voltage of the signal source. If a radio receiver is used, connections are made for 455-kc calibration as shown in Fig. 10-2.

The detector input circuit is heavily loaded, and the peak-to-peak VTVM indicates considerably less than the true signal voltage. However, this is not a matter for concern. It is

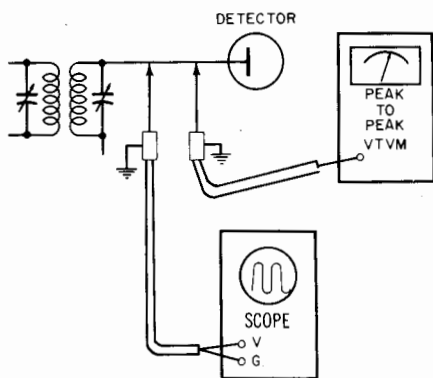

Fig. 10-2. Calibrating the probe and the scope.

necessary to work only from a known signal voltage. The vertical-gain control of the scope is adjusted for a convenient number of deflection intervals on the screen, and the reading of the peak-to-peak VTVM is noted. Signal amplitudes, in turn, can be measured on the scope screen until the probe adjustment is to be changed.

### GAIN MEASUREMENTS

An uncalibrated scope can be used for gain measurements, because the gain figure is merely a ratio. Connect the output

from an AM signal generator to the antenna-input terminals of the receiver, or couple the output via a small coil into the loop antenna. When the high-frequency probe of the scope is transferred from the grid to the plate terminal of an IF stage, for example, the comparative heights of the two displays give a measure of stage gain, as seen in Fig. 10-3.

This is a basic display, but it is difficult to work with because the first waveform has a comparatively low amplitude. The decade attenuator of the scope is utilized accordingly. A simple example is this: if the first waveform has the same amplitude as the second waveform when the decade control is advanced one step for the first test, the stage gain is 10. The

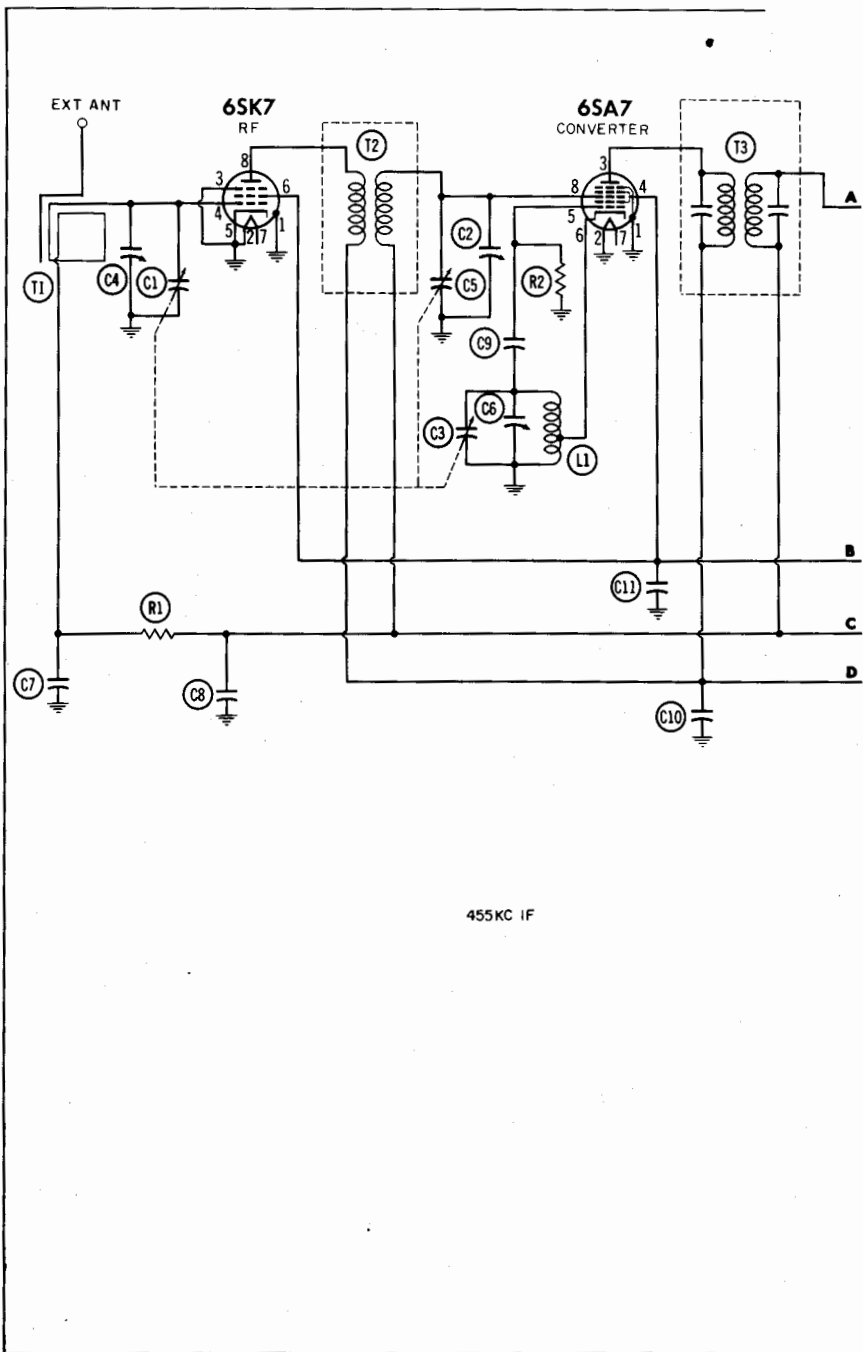

Fig. 10-3. Basic gain displays.

gain of a stage in normal operation depends upon the AVC bias voltage, and this, in turn, depends upon the signal level. The receiver is therefore stabilized preferably with a standard AVC clamp voltage, such as  $-1.5$  volts.

It is important to be accurate in making gain measurements, and not to use the probe with an excessively high capacitance adjustment. This detunes an IF transformer objectionably, and also makes the gain figure incorrect. Also, do not overload the receiver with a high input signal from the generator. The signal will be clipped, and a false gain figure will be obtained. The normal gain for an IF stage cannot be calculated easily, and reference should be made to the receiver service data, or to a comparative check in a normally operating receiver.

The difficulty in making gain calculations is seen from an inspection of the circuit diagram in Fig. 10-4. Although the tube type is known, its mutual conductance depends upon the AVC clamp voltage. This information can sometimes be obtained from a tube manual, but the plate-load impedance into which the tube works can be determined only with lab-type equipment. Reliance must be placed, therefore, on service data for the particular receiver configuration, or on comparative data obtained from a similar receiver which is operating normally.



455KC IF

Fig. 10-4. Typical AM

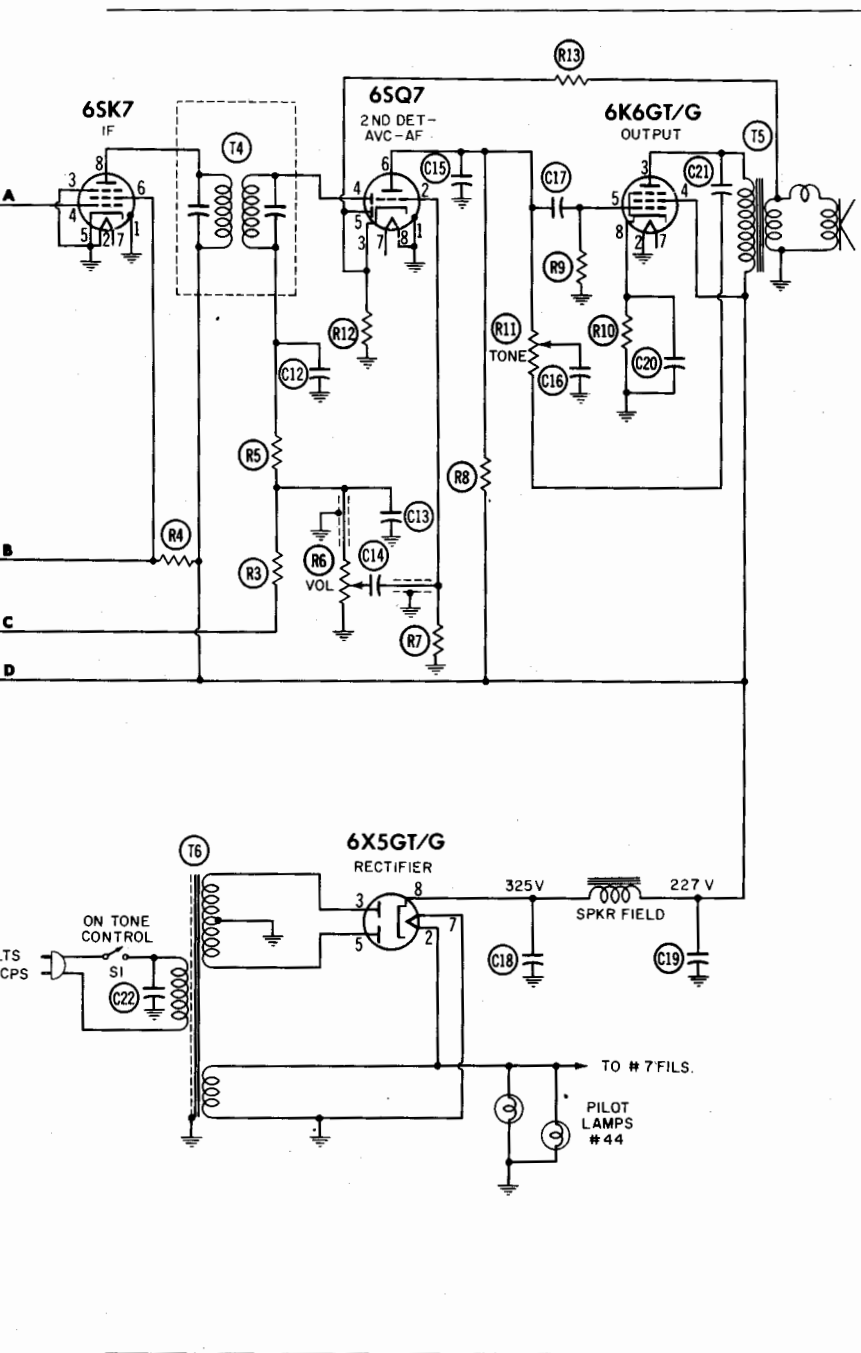

radio-receiver configuration.

## TYPE OF TEST SIGNAL

An amplitude-modulated test signal is illustrated in Fig. 10-3. Modulation is necessary when using an ordinary signal tracer, but an unmodulated (CW) signal can be used when checking through the RF and IF circuits with a scope. Patterns appear in such a case as in Fig. 10-5. This photo shows individual IF cycles because the horizontal-deflection rate of the scope was suitably increased. A much lower deflection rate is used when displaying patterns such as are shown in Fig. 10-3. Internal sync is used to lock the pattern, in either case.

A CW signal is, of course, not suitable for checking the circuit *past* the detector, even if a DC scope is used. Although the detector generates a DC output voltage in response to a CW signal, this output is blocked by the audio coupling capacitor. Therefore an amplitude-modulated signal must be used in these tests. A modulation depth of 30% is standard, but is not necessary.

Beginners are occasionally amazed to observe that the shape of the modulation envelope may change greatly as the generator is tuned through the receiver passband (see Fig. 10-6). This is the result of incidental FM in the output of the AM generator. The photos were made using a poor-quality generator having excessive incidental FM. The situation is aggravated by using a high percentage of modulation. As shown in Fig. 10-7, less change in envelope shape results with tuning when the modulation percentage is reduced, because the incidental FM is then less.

## OSCILLATOR DEFECTS

The applied test signal is of no concern when checking the oscillator because the oscillator is a self-generating circuit. If the oscillator is not dead, a pattern such as in Fig. 10-5 is observed, regardless of whether or not an input signal is present. The normal amplitude of the oscillator output may be given in the receiver service data, or a comparative test can be made in another receiver with the same tube lineup as the receiver under test.

A defective oscillator circuit occasionally has an output signal of normal amplitude, but runs off-frequency, making the receiver appear to be dead. This is a particularly difficult trouble condition when appreciable preselection is used in the receiver. It is a simple matter, however, to measure the oscillator frequency with a scope. Observe the number of peaks in the oscillator waveform which are displayed on the scope screen. Then, apply the signal-generator output directly to the scope,

Fig. 10-5. The unmodulated output from the signal generator.

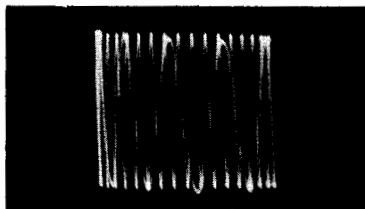

and tune the generator for the same number of peaks. The reading on the generator dial is then the same as the oscillator frequency. In normal operation, the oscillator frequency will differ from the RF input frequency by 455 kc. Even though the receiver dial may not be highly accurate, this procedure serves as a rough guide in evaluating oscillator operation.

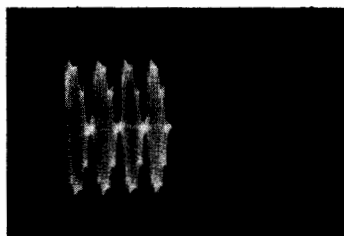
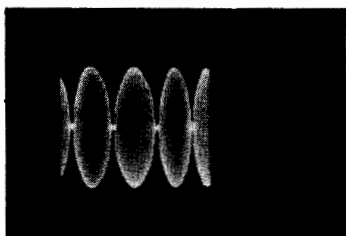

Fig. 10-6. Envelope changes with receiver tuning due to incidental FM.

For a more accurate determination, apply an RF signal from the generator to the receiver and connect the scope probe to the preamplifier output. Then tune the generator for maximum scope deflection. If the circuit is operating properly, the reading of the generator dial will then differ 455 kc from the oscillator frequency.

If the oscillator frequency measures incorrectly (usually too high), look for an open capacitor in the circuit. A defective oscillator coil is a less frequent trouble cause, but it is a possibility. To summarize, a preliminary scope test of the oscillator in case of a "dead receiver" complaint can often save considerable time.

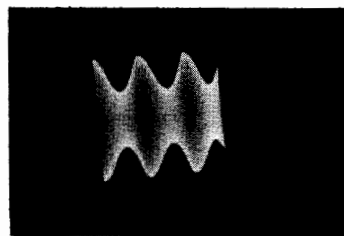
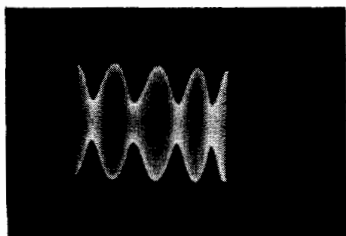

Fig. 10-7. Envelope variation at lower percentage modulation.

## IF STAGE TROUBLES

IF trouble symptoms range from weak output and/or distorted output to regeneration and spurious oscillation. Weak output is easily pinpointed by stage-gain checks. When a weak stage is located, check the DC voltages at the associated tube. A leaky screen-bypass capacitor or an increase in value of a dropping resistor can reduce the screen voltage and cause a weak output. An open screen-bypass capacitor does not change the DC screen voltage appreciably, but it reduces stage gain because of negative feedback.

Excessive control-grid bias reduces gain, and can occur when an AVC decoupling resistor is broken or otherwise open. The associated grid then "floats" and develops a high negative DC voltage from rectification of stray-field voltage. An open grid-return circuit has an extremely high impedance, and couples strongly into stray fields. Check also the IF transformer at the low-gain point, if advisable or necessary. Corrosion or mechanical defects can cause excessive signal loss. Such defects usually make it impossible to peak the transformer, although this is not always the case.

Low gain occurs in many receivers when a plate-decoupling capacitor is open. This forces the plate signal to return to ground through the power supply, which can have an objectionably high impedance at 455 kc. Circuits in which a plate decoupling capacitor does double duty can also develop low gain due to out-of-phase feedback from another circuit. Leakage in the decoupling capacitor results in low DC plate voltage. This does not reduce gain greatly at low signal levels, but compresses and distorts the signal at normal operating levels.

Receivers like the one shown in Fig. 10-4 have a multiole-duty screen-bypass capacitor. If the capacitor is low in value, regeneration can develop. This causes the receiver to tune very sharply and distort a broadcast signal. The bandwidth of an IF stage is reduced greatly when regeneration occurs. Use the scope to check for signal voltage across the bypass capacitor. If appreciable signal is present, replace the capacitor.

Again, if a multiple-duty screen-bypass capacitor opens up completely, the receiver can break into violent oscillation. Symptoms vary from a motorboating sound to a "dead" receiver. In the latter case, a DC voltage measurement at the detector output will show a very high value (the detector rectifies the high-level oscillation voltage). The scope shows a high-level IF signal, with no RF signal applied to the receiver input.

If the receiver oscillates with the AVC clamp voltage removed, but stabilizes when the clamp voltage is connected,

then look for an open bypass capacitor on the AVC line. A leaky AVC bypass causes overload distortion until the clamp voltage is applied, after which the receiver operates satisfactorily on normal signal levels.

### AUDIO STAGE TESTS

If signal-tracing method shows that the circuits up to the detector are operating normally, exchange the high-frequency probe for a low-capacitance probe, and then proceed to check the waveforms past the detector. If there is weak or no output from the detector, the charging capacitor is first suspected. The capacitor may be leaky, shorted, or open. A cathode resistor which is open or greatly increased in value causes weak or no output. An open detector decoupling resistor, or one which has increased in value, is a less common cause of weak or no detector output.

Audio stage-gain tests are made in the manner described previously. A typical pair of patterns is shown in Fig. 10-8.

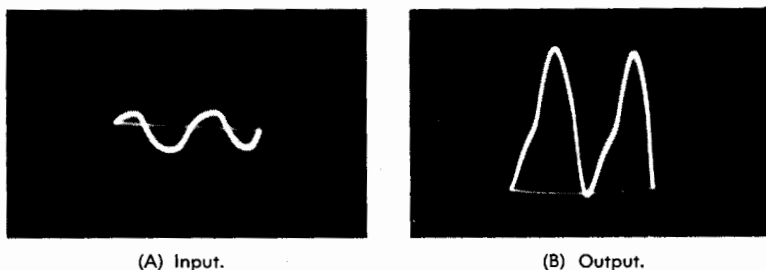

Fig. 10-8. Gain check of an audio-output stage.

In this example, the input waveform is not a true sine wave because of the generator characteristic. However, the output waveform is considerably different in shape from the input waveform, because the stage is distorting. In economy-type receivers, such distortion is unavoidable, and does not cause customer dissatisfaction. On the other hand, in an expensive receiver, an investigation would be made to determine the cause.

In case the gain is low and/or distortion excessive, check the DC voltages and circuit resistances first. Follow up with tests for open capacitors in the faulty stage. In the case of an open coupling capacitor, the scope will show normal signal at the input end of the capacitor, but little or no signal at the output end. In tracking down a distorted audio signal, do not be confused by inversion of the distorted signal from grid to plate. A conventional amplifier shifts the phase of the input



signal 180°. Thus a waveform which is clipped at the top in a grid circuit will be clipped at the bottom in the plate circuit.

### HUM TRACING

When there is objectionable hum in the speaker output, check the power-supply ripple first. A filter capacitor may have marginal value, or a filter choke might be defective. If the ripple is not abnormally high, the hum voltage is probably entering at some point in the signal circuits. Trace back from the speaker with the scope to find where the hum first appears. A shielded lead in the audio-input stage, for example, may be poorly grounded. Or, a defective socket can inject hum voltage from the heater into a cathode circuit which operates above ground. Socket leakage between heater and grid terminals also causes audible hum.

In summary, a scope is the most effective radio signal tracer which has yet been devised. A little time spent in familiarizing yourself with the waveforms in radio-receiver circuits can multiply your technical efficiency greatly. This study also pays an intangible dividend in the personal satisfaction of learning the fine points of circuit action. The "screwdriver mechanic" will usually have a job, but the professional technician will quite likely be his boss.

## CHAPTER 11

# Testing Audio Amplifiers

A wide variety of useful tests can be made in audio equipment with a scope. Such equipment ranges from the simple audio amplifiers used in table-model radios, through commercial-sound installations, to high-fidelity amplifiers. The vertical and horizontal amplifiers in service-type scopes are seldom capable of hi-fi response. It might therefore be supposed that accurate checks of distortion could not be made. It is a general rule that test equipment must have performance characteristics equal to or better than the device under test. There are however certain exceptions, which are made possible by suitable test techniques.

### LINEARITY CHECKS

Amplitude nonlinearity is a basic cause of distortion in audio amplifiers. In order to make a linearity test with a scope, first determine the linearity of the scope itself. This provides a reference pattern for use in evaluating the linearity of an audio amplifier. Connect the output from an audio oscillator to both the vertical- and horizontal-input terminals of the scope, as

Fig. 11-1. Check of scope linearity.

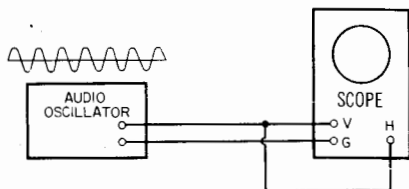

shown in Fig. 11-1. (The waveform of the audio oscillator is of no concern here.) Now set the audio oscillator frequency to approximately 400 cycles. A diagonal-line display appears on the scope screen.

If the scope amplifiers are linear, a perfectly straight line is displayed. If the amplifiers are not linear, the line may have

some curvature, as in Fig. 11-2. For an accurate evaluation, place a straight-edge along the pattern. This is the *reference* pattern used in the following test. Connect the equipment as shown in Fig. 11-3. Load resistor R must have adequate wattage rating, and its resistance should equal the recommended load impedance for the amplifier. The amplifier should be driven to its maximum rated power output. Power output is determined by measuring the AC voltage across R. The voltage is measured in rms units, with an ordinary VOM. The power in watts is equal to  $E^2/R$ .



Fig. 11-2. Reference linearity pattern.

Now, observe the pattern on the scope screen. If it is exactly the same as the reference pattern, the amplifier under test is linear. On the other hand, more or less nonlinearity is indicated by more or less departure from the reference pattern. If the amplifier under test has good performance characteristics, there may be some doubt whether or not the scope pattern really shows any departure from reference. In fact, very small amounts of nonlinearity are difficult to evaluate with certainty.

An amplifier which has substantial nonlinearity at high power output usually shows less nonlinearity when the power output is reduced. Any amplifier develops increasing non-

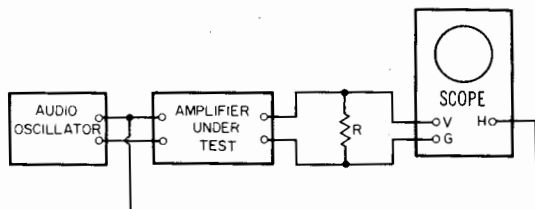

Fig. 11-3. Amplifier linearity check.

linearity as the power output is increased. Objectionable nonlinearity at rated power output can be caused by incorrect grid bias, low plate or screen supply voltages, defective transformers, off-value resistors, or open bypass capacitors. Leaky coupling capacitors change the normal grid bias on a tube. Leaky or shorted cathode-bypass capacitors change the normal cathode bias. If a coupling capacitor is low in value, the preceding

stage must be overdriven to obtain rated power output, with resulting nonlinearity. An open capacitor in a feedback network causes amplitude nonlinearity.

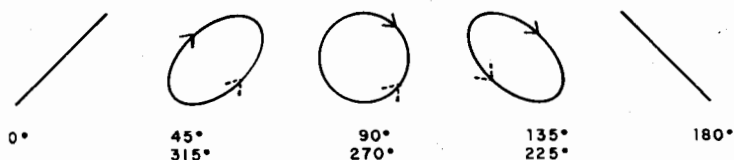

Fig. 11-4. Typical phase-shift patterns.

### PHASE SHIFT

Unless the amplifier is defective, it is very unlikely that you will observe any phase shift in the pattern at 400 cycles. Phase shift in the amplifier under test causes the line pattern to open up into an ellipse. The proportions of the ellipse indicate the amount of phase shift. Some key patterns are illustrated in Fig. 11-4. Amplifier defects resulting in phase shift include low-value coupling, decoupling, and bypass capacitors, defective transformers, or a defect in the feedback circuit.

Any amplifier, including the scope amplifiers, will exhibit phase shift at some limiting upper frequency. Here, stray circuit capacitances begin to become significant. The stray capacitances have a partial bypassing effect around plate-load resistors in particular, causing the load to become noticeably reactive at the high test frequency. Phase shift is always the result of reactance. Unless amplifiers are DC-coupled, they also exhibit phase shift at some limiting low frequency. This occurs because the values of coupling, decoupling, and bypass capacitors are insufficient to maintain negligible reactance at the low test frequency.

In case of simultaneous amplitude nonlinearity and phase shift, a distorted ellipse is displayed. The ellipse appears more or less flattened, skewed, or egg-shaped with one end more "open" than the other. In hi-fi amplifiers, nonlinearity is more objectionable than phase shift, because listeners detect nonlinear distortion more readily than phase shift in the audible output. The better hi-fi amplifiers are designed however to minimize phase shift.

### LINEAR TIME-BASE DISPLAYS

Beginners often ask why the cyclogram test depicted in Fig. 11-3 is preferred to a display on a linear time base (sawtooth

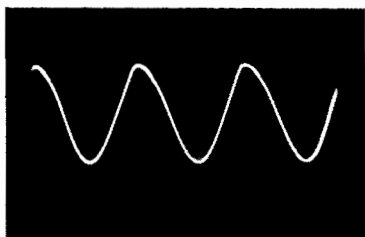

Fig. 11-5. Distorted sine wave.

deflection). The reason is that small amounts of distortion are much more difficult to observe on a linear time base. If substantial distortion is present, as in Fig. 11-5, it is immediately evident, but on the other hand, it is practically impossible to observe small amounts of distortion. If a linear time base is used, adopt the same precautions in establishing a reference pattern, as previously described. Connect the audio-oscillator output directly to the scope's vertical-input terminals, and ob-

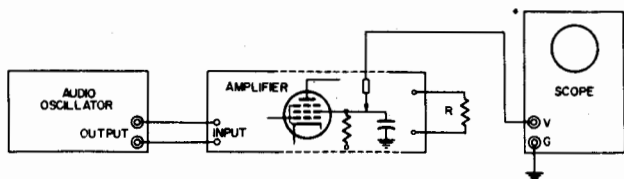

Fig. 11-6. Checking a screen-bypass capacitor.

serve this reference pattern. It shows the combined effect of observable distortion in the generator waveform, plus possible additional distortion from the scope's vertical amplifier.

Where the technician is concerned only with the signal amplitude, as in gain measurements, a linear time base serves satisfactorily. It is also appropriate for checking bypass capacitors, as seen in Fig. 11-6. If the bypass capacitor is satisfactory at the test frequency, little or no AC voltage is present. An open capacitor, however, causes a large deflection on the scope screen. A linear time base is also used when a scope supplements a harmonic-distortion meter, as shown in Fig. 11-7. The harmonic-distortion meter filters out the fundamental in the test frequency, and passes the harmonics. The meter indicates only the percentage of harmonic distortion, but the scope will show whether second, third, or higher harmonics are present.

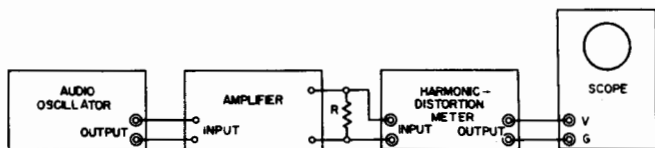
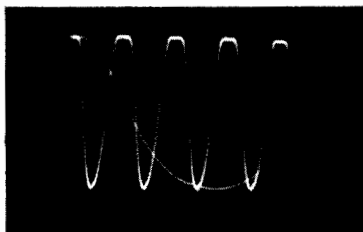

Fig. 11-7. Scope identifies the nature of distortion.

When the positive peaks of a sine wave are clipped or compressed (Fig. 11-8), even harmonics are generated. The waveform is unsymmetrical. If both positive and negative peaks are clipped *equally*, the resulting waveform is symmetrical, and odd harmonics are generated. Again, if positive and negative peaks are clipped *unequally*, both odd and even harmonics are developed. *Any change* in the shape of a sine wave, no matter how gradual and regardless of the portion of the wave affected, generates harmonics.

Fig. 11-8. Severe even-harmonic distortion of a sine wave.



Parasitic oscillation is identified easily in scope tests. It causes a "bulge" on the waveform, usually at the peak. (See Fig. 11-9.) The bulging or ballooning interval consists of a high-frequency oscillation, generally occurring on the peak of drive to a tube which is being driven into grid current flow. When the grid is being driven positive, the grid-input resistance falls to a comparatively low value. Stray reactances in leads and transformer windings can then "see" a high Q which permits a brief interval of high-frequency oscillation. Parasitic oscillation is commonly controlled by connecting small resistors in series with the grid and plate leads at the socket terminals.

Fig. 11-9. Appearance of parasitic oscillation on a sine wave.

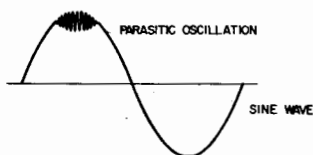

Notch distortion, if appreciable, can also be seen in a scope pattern. This difficulty occurs principally in push-pull amplifiers which are incorrectly biased. This distortion is exhibited as irregularities in the shape of the sine wave in passing through the zero axis. Notch distortion is aggravated by high-level drive. Any push-pull amplifier develops this type of distortion when driven too hard. If the distortion occurs at rated power output, check the bias voltages at the push-pull tubes. If the bias is correct, check for low plate or screen voltages.

## SQUARE-WAVE TESTS

High-fidelity amplifiers are often rated for a square-wave response. A different class of information is provided by square-wave tests, which supplements the data from steady-state tests with an audio oscillator. The leading and trailing edges of a square wave are very steep and therefore the rise and fall times of an amplifier become apparent. This is sometimes referred to as the attack-time of the amplifier. It is a transient response, as contrasted to a steady-state response. In theory, it is possible to deduce the transient characteristics from a study of the frequency and phase response over the passband of the amplifier. Practically, however, this becomes almost prohibitively difficult, particularly when several audio stages are cascaded.

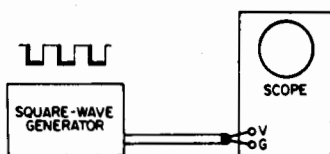

Fig. 11-10. Checking the transient response of the scope.

Most oscilloscopes have vertical amplifiers which exceed the capabilities of a hi-fi amplifier in square-wave tests, but this is not true of all. It is advisable, therefore, first to check the transient response of the scope, as depicted in Fig. 11-10. Any distortion over the contemplated range of square-wave test frequencies must be taken into account, so that it is not improperly charged to deficiencies in the audio amplifier. It is common to find tilt in the top of a 60-cycle square wave, as seen in Fig. 11-11. In an AC scope, the coupling, decoupling, and bypass capacitors in the vertical amplifier may be too small in value to reproduce a 60-cycle square-wave without tilt. Or, the square-wave generator itself may not be free from tilt at low frequencies.



Fig. 11-11. Tilt in the top of a square wave is caused by low-frequency attenuation and phase shift.



Fig. 11-12. Low-frequency overcompensation causes top of square wave to slope uphill.

When a 60-cycle square wave is passed through the audio amplifier, any tilt contributed by the amplifier will be added to the reference waveform. It is much less common to find uphill tilt, as shown in Fig. 11-12. This response is caused by overcompensation of low frequencies. In audio amplifiers, the cause is usually traced to a defect in the feedback network. An open capacitor in some feedback circuits can result in more negative feedback at low frequencies than at high frequencies.

Theoretically, a 60-cycle square-wave test gives all the information about transient response which can be obtained. There is no reason why tests are required at higher square-wave frequencies. A practical difficulty arises, however, in evaluating the extremely high harmonic responses from a 60-cycle test. High harmonics have less amplitude, and their effect on the reproduced waveform tends to be masked by low-frequency harmonics. Moreover, fine detail of corner reproduction is so highly compressed at low test frequencies that the display is not readily evaluated. Finally, attack time becomes plainly visible only at high test frequencies, when ordinary sawtooth deflection is used.

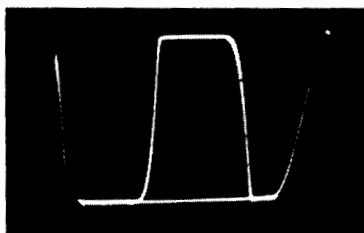

Fig. 11-13. Slow rise and fall times.

The meaning of attack time is seen in Fig. 11-13. It is the time required for the square wave to rise from 10% to 90% of its final amplitude. In order to measure attack time, advance the square-wave test frequency until the attack interval occupies a usable horizontal interval. Compare the attack interval with the total interval for one complete square-wave cycle. Knowing the frequency of the square-wave signal, its period (time of a complete cycle) is given by the reciprocal of the frequency. The attack time is given, in turn, by the fraction of the total interval occupied by the attack interval.

### OVERSHOOT

Overshoot is a characteristic often associated with attack time (Fig. 11-14). An amplifier which has a very short attack time may, in turn, display objectionable overshoot. High-fidelity amplifiers are occasionally rated for overshoot at a



specified square-wave frequency. This rating is given as a percentage. To measure percentage overshoot, compare the amplitude of the overshoot pulse with the total amplitude of the square wave between its flat-topped portions.

Causes of overshoot are a rising high-frequency response in the amplifier circuits (sometimes due to a defective feedback network), or to uncoupled inductance in transformers. Make certain that the amplifier under test is working into the rated load. Some amplifiers are more load-sensitive than others.

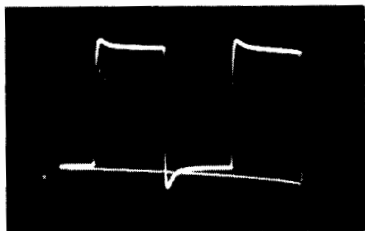

Fig. 11-14. Overshoot occurring in a square-wave pattern.

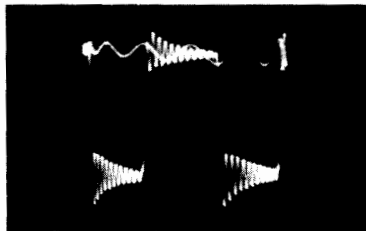

Fig. 11-15. Severe ringing occurring in square-wave pattern.

Overshoot may be accompanied by ringing, as shown by the severe situation in Fig. 11-15. When ringing is encountered, first check the feedback network. Defective transformers can also be responsible for this symptom.

Most audio transformers ring and otherwise distort a square wave if the test frequency is too high. Hence, a meaningful test is obtained only within the square-wave limits specified by the manufacturer. An improperly loaded transformer may also

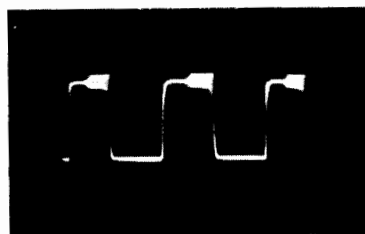

Fig. 11-16. Parasitic oscillation occurring in square-wave tests.

ring within its rated range. Normal loading damps the windings and suppresses the response of uncoupled inductance and distributed capacitance. Therefore, in event of difficulty, check for circuit defects which may reduce normal loading for even a high-resistance connection can be responsible.

Parasitic oscillation occasionally occurs in square-wave tests (Fig. 11-16) just as in sine-wave tests. If the output from the square-wave generator is reduced, the spurious oscillation

usually will disappear. It is eliminated in most cases by connecting 50-ohm resistors at the plate and grid terminals of the offending tube. If due to a defective feedback network, suppression resistors will not help—the defective component must be located and replaced.



## INDEX

### A

- Above-ground test methods, 133-134
- AC test voltage, 13-16
- Adjustment
  - centering-control, 7-9
  - focus-control, 9-11
  - intensity-control, 7
- AFC or oscillator troubles, 89-90
- Alignment curves, sweep, 51
- Amplification, nonlinear, 26
- Amplifier
  - circuit
    - horizontal, 24
    - vertical, 21
  - linearity check, 146
  - RF, troubleshooting, 59-63
  - sawtooth oscillator and blanking, 24
  - section, video-IF, 64
  - video
    - circuit, 72
    - signal tracing in, 71-76
    - wide-band, 54
- Amplitude control, horizontal, 11-13
- Astigmatism control, 9-10
- Attenuator
  - dual-band step, 53
  - step, 30
- Audio-output stage, gain, check of, 143
- Audio stage tests, 143-144
- Automatic
  - centering, 81
  - sync function, 34-36

### B

- Balanced vertical input to scope, 133
- Basic gain displays, 137
- Blanking
  - circuit, vertical-retrace, 115
  - network, vertical, 115-117
  - retrace, 25
- Boost-voltage filtering, 106
- 'BU8 circuit, 77-80
- Bypassing, incidental, function, 130-131

### C

- Cable, coaxial, 42
- Calibrating facilities, 27
- Calibration voltage measurements, 26-28
- Capacitance-divider high-voltage probe, 49-51
- Capacitor
  - coupling
    - checks, 111-112
    - leaky, 78
    - screen-bypass, checking of, 148
  - Cathode circuit, 114-115
  - Centered sine wave, 80
  - Centering, automatic, 81
  - Centering-control adjustment, 7-9
  - Checking drive, 98
  - Checks
    - coupling capacitor, 111-112
    - linearity, 145-147
    - cathode, 114-115

## Checks—cont'd

- ghosts, 76
- horizontal-amplifier, 24
- loading, 43, 123
- variations, 85-86
- vertical-amplifier, 21
- vertical-retrace blanking, 115
- video-amplifier, 72

## Circuit

- 'BU8, 77-80
- circular cyclogram, 38
- clipped sine wave, 22
- coaxial cable, 42
- comparison waveform, 96
- complex waveforms, 29-30
- compressed sync pulses, 67
- compression, white, 73-74
- compromise-type demodulator probe, 46

## Configuration

- front-end, 60-61
- stacked B+, 127-128
- sync-separator, 77

## Contrast, low, 69-70

## Control

- astigmatism, 9-10
- centering, adjustment, 7-9
- focus, adjustment, 9-11
- frequency, 24-25
- horizontal-amplitude, 11-13
- horizontal-function, 11-13
- intensity
  - adjustment, 7
  - setting, 16-17
- potentiometer gain, 20
- sync, 16
- vertical-centering, readjustment of, 80-81

## Controls

- frequency, 14
- gain, 17-24
  - horizontal, 23-24
  - step, 20-23
  - vertical, 17-20

## Coupling capacitor

- checks, 111-112
- leaky, 78

## Current waveforms, 131-132

## Curve, response, 66

## Curves, sweep-alignment, 51

## Cyclogram, circular, 38

## D

### DC scope response, 31

### DC versus peak-to-peak volts, 30-32

### Defects, oscillator, 140-141

### Definition, poor, 74-76

### Demodulator probe, compromise type, 46

### Demodulator probes, 45-48

### Differentiation in square wave, 76

### Display, linear time-base, 147-149

### Displays, basic gain, 137

### Dividers, voltage, 20

## Drive

### checking, 98

### low, 101-102

### Dual-band step attenuators, 53

## E

### External sync function, 32-34

## F

### Facilities, calibrating, 27

### Fall and rise times, slow, 151

### Feedback waveforms, 112-113

### Fields, stray, 51-52

### Filter, input waveform to, 128-130

### Filtering boost voltage, 106

### Fluctuating line voltage, 41

### Focus-control adjustment, 9-11

### Frequencies, high and low, 20

### Frequency controls, 14, 24-25

### Front-end configuration, 60-61

## Function

### control, horizontal, 11-13

### sync, 32-36

#### automatic, 34-36

#### external, 32-34

## G

## Gain

### check of audio-output stage, 143

### controls, 17-24

#### horizontal, 23-24

#### potentiometer, 20

#### step, 20-23

#### vertical, 17-20

Gain—cont'd

- displays, basic, 137
- measurements, 136-137
- stage, 69-70

Ghosts, circuit, 76

Graticules, 9

Ground-circuit difficulties, 70-71

Ground lead of scope probe, 55-58

**H**

High frequencies, 20

High-voltage

- capacitance-divider probe, 49-51
- power supply, 104-105

Horizontal

- amplifier circuit, 24
- amplitude control, 11-13
- function control, 11-13
- gain control, 23-24
- nonlinearity, 26
- oscillator
  - and AFC configuration, 87
  - circuit variations, 97
  - section, signal tracing in, 91-93

Hum bar in picture, 68

Hum in IF signal, 68-69

Hum tracing, 144

Hybrid sine and square waves, 73

**I**

IF

- section, signal tracing in, 63-71
- signal, hum in, 68-69
- stage troubles, 142-143

Incidental bypassing function, 130-131

Input waveform to filter, 128-130

Integrator input waveforms, 110

Intensity-control adjustment, 7, 16-17

Intercarrier-section test signal, 118-123

Inverter, phase, 82-84

Isolating probe, resistive, 48

**J**

Jumping pattern, 41

**K**

Key square-wave reproductions, 39

Keystoning, 106-107

**L**

Leaky coupling capacitor, 78

Limiter characteristics, 123-126

Line voltage, fluctuating, 41

Linear time-base display, 147-149

Linearity checks, 145-147

Lissajous patterns, 36-37

Loading, circuit, 43

minimizing, 123

Looker point, 59

Loss of sync, 67

Low-C probe response, 54-55

Low-capacitance probe, 43-45

adjustment of, 44-45

configuration, 43-44

Low

contrast versus stage gain, 65-70

drive, 101-102

frequencies, 20

**M**

Magnifier, sweep, 36

Measurements

calibration voltage, 26-28

gain, 136-137

peak-to-peak voltage, 26-28

Modulated sine wave, 55

Multivibrator and ringing-coil configuration, 95-97

**N**

Narrow-band versus wide-band response, 53

Narrow picture, 102-103

Narrow pulses, 37-38

Negative pulses, 80

Network, vertical-blanking, 115-117

Noise-gate signal, 79

Nonlinear amplification, 26

Nonlinearity, horizontal, 26

O

- Oscillation, parasitic, 149, 152
- Oscillator defects, 140-141
- Oscillator or AFC trouble, 89-90
- Oscilloscope, simple, 8
- Output, phase-inverter, 84
- Output transformer, vertical, 113-114
- Overloading, 22
- Overshoot, 151-153

P

- Parasitic oscillation, 149, 152
- Pattern, stray-field, 52
- Pattern jumping, 41
- Patterns, Lissajous, 36-37
- Peak-to-peak
  - versus DC volts, 30-32
  - voltage measurements, 26-28
- Phase-inverter stage, 82-84
- Phase shift, 147
- Picture
  - hum bar in, 68
  - narrow, 102-103
  - pulling, 67
  - quality, poor, 65-67
- Point, looker, 59
- Poor
  - definition, 74-76
  - picture quality, 65-67
- Positive pulses, 80
- Potentiometer gain control, 20
- Power supply, high-voltage, 104-105
- Probe
  - demodulator, 45-48
  - high-voltage capacitance-divider, 49-51
  - low-capacitance, 43-44
    - adjustment of, 44-45
    - configuration, 43-44
  - resistive isolating, 48
  - response, low-C, 54-55
  - scope, ground lead of, 55-58
- Pulling, picture, 67
- Pulse waveform, 29, 96
- Pulses
  - narrow, 37-38
  - negative, 80

- Pulses—cont'd
  - positive, 80
  - sync, compressed, 67

R

- Raster, shaded and pincushioned, 106
- Readjustment of vertical-centering control, 80-81
- RF amplifier, troubleshooting, 59-63
- Reproductions, key square-wave, 39
- Requirements of scope, 135-136
- Response
  - curve, 66
  - DC scope, 31
  - low-C probe, 54-55
  - scope, transient, 150
  - wide-band versus narrow-band, 53
- Resistive isolating probe, 48
- Retrace blanking, 25
- Ringing, 76
- Ringing-coil
  - and multivibrator configuration, 95-97
  - check, 93
- Ringing in square wave, 152
- Rise and fall times, slow, 151

S

- Sawtooth
  - oscillator and blanking amplifier, 24
  - waveform, 96
- Scope
  - DC, response of, 31
  - probe, ground lead of, 55-58
  - requirements, 135-136
  - transient response, 150
  - vertical balanced input, 133
- Screen-bypass capacitor, checking of, 148
- Separated sync signal, 78
- Setting intensity control, 16-17
- Shaded and pincushioned raster, 106

Shift, phase, 147  
Shorted turns, test setup for, 114  
Signal  
  IF, hum in, 68-69  
  noise-gate, 79  
  sync, separated, 78  
  test  
    for intercarrier section, 118-123  
    type of, 140  
    video, undistorted, 67  
Signal tracing  
  horizontal-oscillator section, 91-93  
  IF section, 63-71  
  in video amplifier, 71-76  
Simple oscilloscope, 8  
Sine wave  
  centered, 80  
  clipped, 22  
  modulated, 55  
Single-cycle display, 15  
Slow rise and fall times, 151  
Sound-section configuration, 119  
Square wave, 38-41  
  differentiation in, 76  
  reproductions, key, 39  
  ringing in, 152  
  tests, 150-151  
Stacked B+ configuration, 127-128  
Stage, phase-inverter, 82-84  
Stage gain  
  test setup, 69  
  versus low contrast, 69-70  
Step attenuator, dual-bandwidth, 53  
Step attenuators, 30  
Step-gain control, 20-23  
Stray fields, 51-52  
Supply, power, high-voltage, 104-105  
Sweep-alignment curves, 51  
Sweep circuit, troubleshooting, 100-101  
Sweep magnifier, 36  
Sync  
  control, 16  
  function, 32-36  
    automatic, 34-36  
    external, 32-34  
  loss, 67  
  pulses compressed, 67

Sync—cont'd  
  separator  
    configuration, 77  
    with phase-inverter stage, 82-84  
  signal, separated, 78  
Synchroguide ringing-coil check, 93  
Synchronization, vertical, 108-111

## T

Test  
  methods, above-ground, 133-134  
  setup  
    for shorted turns, 114  
    stage-gain, 69  
  signal  
    for intercarrier section, 118-123  
    type of, 140  
    voltage, AC, 13-16  
Tests  
  audio stage, 143-144  
  square-wave, 150-151  
Time-base display, linear, 147-149  
Tracing hum, 144  
Transformer, vertical-output, 113-114  
Transient response, scope, 150  
Troubles, IF stage, 142-143  
Troubleshooting  
  RF amplifier, 59-63  
  sweep circuit, 100-101

## U

Undistorted video signal, 67

## V

Vertical  
  -amplifier circuit, 21  
  blanking network, 115-117  
  -centering control, readjustment of, 80-81  
  -gain control, 17-20  
  input to scope, balanced, 133  
  -output transformer, 113-114  
  -retrace blanking circuit, 115  
  synchronization, 108-111  
Video  
  -amplifier circuit, 72  
  signal tracing in, 71-76



Video—cont'd

- IF amplifier system, 64
- signal, undistorted, 67

Voltage

- AC test, 13-16
- boost, filtering, 106
- dividers for low and high frequencies, 20
- fluctuating line, 41

**W**

Waveform

- comparison, 96

Waveform—cont'd

- input, to filter, 128-130
- pulse, 29, 96
- sawtooth, 96

Waveforms

- complex, 29-30
- current, 131-132
- feedback, 112-113
- integrator input, 110

Waves, square, 38-41

White compression, 73-74

Wide-band

- amplifier, 54
- versus narrow-band response, 53

# TROUBLESHOOTING WITH THE OSCILLOSCOPE

By ROBERT G. MIDDLETON



## ABOUT THE AUTHOR

Bob Middleton is one of the few professionals engaged in free-lance technical writing as a full-time activity. The tremendous success of his numerous books is undoubtedly due to their originality, and to the fact that they are based on the author's own practical experience. (His home workshop is filled with all kinds of test equipment, receivers, and paraphernalia contrived to aid his ingenious pursuit of faster and easier ways to diagnose electronic equipment troubles.) Other SAMS books by Mr. Middleton include eight volumes in his famous "101 Ways to Use" test equipment series, four "101 Key Troubleshooting Waveforms" volumes, "TV Tube Symptoms & Troubles," "Using the Oscilloscope in Industrial Electronics," and "Bench Servicing Made Easy."

The oscilloscope, one of the most valuable electronic servicing tools, must be used properly in order to realize its full value. Proper use involves knowing the scope's capabilities, how to operate it correctly, what probes to use, which test signals are needed, the type of waveforms to expect, and how to interpret them. All of these points are covered by author Bob Middleton in this practical, comprehensive volume.

The first two chapters are devoted to operating the scope, and the selection and use of probes. The purpose and function of each operating control are fully explained and illustrated, as are probe adjustment and matching, the classes of probe tests, and the reasons for using specific probes. The next seven chapters show you how to use the scope when troubleshooting TV receivers. You learn how to determine the defective section or stage by waveform analysis. Numerous incorrect waveforms associated with various defective components are shown and discussed. The last two chapters deal with procedures that can be used when servicing radio receivers and audio amplifiers, rounding out the coverage to provide you with background in using a scope to check practically any electronic circuit.



HOWARD W. SAMS & CO., INC.

THE BOBBS-MERRILL COMPANY, INC.

\$2.50  
TOS-1