

Telephone Technology

(Conclusion)

Troubleshooting and repair techniques

By Stephen J. Bigelow

Last month in Part I, we introduced major assemblies that make up the telephone instrument and detailed how these elements perform together with the Central Office. Also covered were typical techniques used in the installation of telephone instruments at a customer's location. In this concluding installment, we will discuss simple and proven techniques for isolating problems to the on-premises telephone instrument and wiring or the telephone line itself, as well as some steps you can take to correct a problem once you identify its cause. Also included is a quick reference troubleshooting chart that should simplify and speed problem solving.

Locating a Problem

Assume your telephone is not working. You lift the handset and listen for a dialtone only to hear nothing at all. There is a quick and simple procedure to follow to determine whether the cause of the problem is in the telephone instrument or at a point before the phone line from the Central Office enters your premises.

Perhaps the easiest way to isolate a problem is to use another telephone instrument that is known to be good in place of the instrument in question. If when you try this you still fail to hear a dialtone at the problem location, you know that the problem lies before the jack into which the instrument is plugged, whether in your on-premises wiring or from there back to the Central Office.

Many homes have one or more tel-

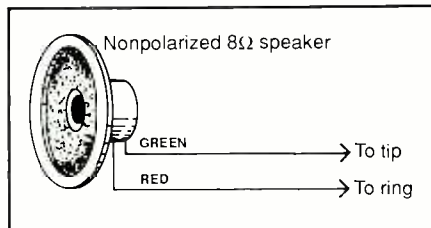

Fig. 13. Using an 8-ohm speaker to check out a phone line for dialtone.

phone jacks at various locations. It is a good idea to try a known-good instrument at each extension jack. If even *one* extension location provides the instrument with a dialtone, you know that your line to the Central Office is working properly and that the problem is within your on-premises extension wiring. Alternatively, if *all* locations fail to provide a dialtone when the instrument is taken off-hook, the problem is most likely from the Central Office.

An easy test you can make to determine whether or not the Central Office is at fault is to trace the wiring in your premises to the point at which the telephone line from the Central Office enters your location. There

will be at this point a central connecting jack—the so-called “telco” jack—that will feed any other extensions that might be installed in your home.

Once you have located the telco jack, use an 8-ohm speaker with short lengths of wire connected to each lug to perform a “speaker test.” To do this, touch one speaker wire to the “tip” (green) and the other to the “ring” (red) terminals of the jack (Fig. 13). The speaker's impedance is low enough to draw loop current to simulate an off-hook condition. If the incoming line is working, the Central Office will sense this off-hook condition and send down the line a dialtone signal that can be heard from the speaker. If you do not hear a dialtone, the problem is definitely outside your premises; to correct it, you must contact your local telephone company (from a working phone, of course) to request service.

Extension failures almost always are caused by an open circuit in part of the connecting cable or at the RJ11 or RJ14 modular connector into which they are plugged or terminated (Fig. 14). Always be suspicious of the

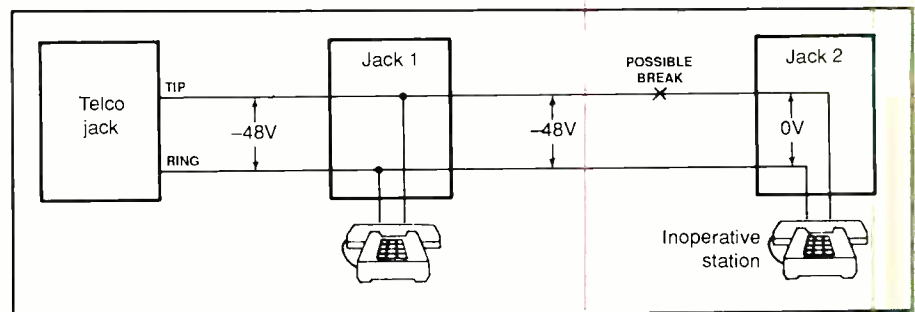

Fig. 14. A multiple-extension residential telephone wiring scheme showing location of possible failure.

the line that connects the telephone instrument to the RJ11 or RJ14 jack. That line is also part of the extension wiring and can just as readily be the source of the problem. Remove the cover from the modular connector and check the wiring at each of the screw terminals and repair any wires that are loose or broken.

If the wiring is secure at the connector, use a dc voltmeter or a multimeter set to the dc function to measure the voltage across the tip and ring contacts by touching the meter's probes to the tip and ring terminals (Fig. 15). If all is okay, you should obtain a -48 -volt reading. If the meter indicates an absence of voltage (0 volt), there is a break somewhere in the cable. Trace the cable as far back as you can to determine if a break is visible. If you cannot locate a break just by looking, or even if you can but it is in an impossible to reach location, you may have to run a whole new cable.

If when you take a voltage reading the meter indicates presence of -48 volts across the tip and ring contacts and a known-good instrument does not work when plugged into the jack, the problem lies within the modular jack itself. In this event, you must replace the jack with a good one to restore service at that given location.

A note on service: Your local telephone company will repair any line problems that are outside your premises free of charge. However, if the problem is on-premises, you will be charged an hourly service fee to repair it. So make certain where the problem lies *before* you call for service.

Instrument Problems

A wide variety of problems can and do surface in telephone instruments. In this section, we will discuss some of the most common troubles encountered in phones and how the major subassemblies of the instrument relate to each other. (Figure 1 in Part

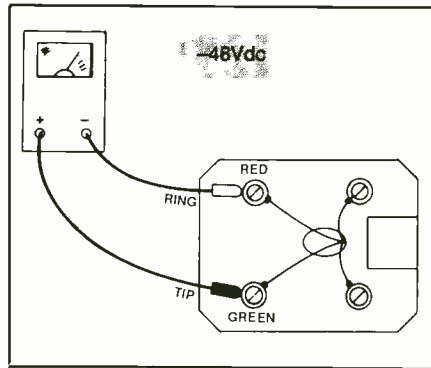

Fig. 15. Using a multimeter set to read dc voltage to check voltage across tip and ring contacts of telephone jack.

It depicts drawings of these elements; so you might want to refer back to it to refresh your memory of them.)

As pointed out last month, there are five major assemblies in *every* telephone instrument. Each has its own set of functions, as follows:

(1) *Hookswitch*. Activates the instrument and switches in the audio and dial portions of the circuit.

(2) *Network*. This is the interconnect point for all parts of the phone that filters and isolates the audio circuit and ringer and provides proper line balance and loss compensation. A wiring diagram of the network in a typical 2500-type telephone instrument is shown in Fig. 16.

(3) *Handset*. This assembly contains the transmitter and receiver (a speaker and microphone may also be present on more sophisticated "hands-free" telephone instruments).

(4) *Dial*. This can be either a rotary mechanism or an electronic Dual Tone Multi Frequency (Touch-Tone) keypad and its electronic circuitry whose purpose is to signal the Central Office the specific digits of the number being called.

(5) *Ringer*. This unit audibly signals you when a call is coming in.

Let us now discuss some possible trouble symptoms, their causes and what you can do to correct them.

• **Phone Totally Dead.** A telephone

instrument is considered to be totally inoperative if it is unable to draw a dialtone in the off-hook condition. With a multimeter set to measure high dc voltage (say, 200 volts) across the tip (green) and ring (red) wires while the defective phone is *on-hook*, you should obtain an indication of -48 volts. When the handset is lifted *off-hook*, the reading should drop to about -6.5 volts.

If you obtain a -6.5 -volt reading, the phone is drawing loop current and dialtone. In this event, try another handset assembly and handset cord to check for a defect in the receiver circuit. If the problem still persists, check the network for loose wires and breaks in the printed-circuit board's copper traces.

If the loop voltage across the tip and ring contacts remains at -48 volts when the phone is off-hook, the instrument is not activating. In this case, check the line cord into the phone to be sure it is in place, is connected properly at both ends and that continuity exists in all conductors.

Keep in mind that an open line cord is a very common problem. If this is not the source of the difficulty, check the contacts in the hookswitch assembly.

• **Low or No Ring.** Conventional electromechanical bells are nothing more than a coil wound around an iron core to form a simple electromagnet. As the ring signal from the Central Office reaches the telephone instrument, the fluctuating voltage varies the magnetic field in first one and then the other polarity. In one polarity, the electromagnet physically pulls a striker arm on the end of which is a ball-like clapper that strikes a gong-like bell to sound a ring tone. As the polarity of the ring voltage reverses, the polarity of the magnetic field also reverses and physically pushes the striker arm away to strike another bell. In some phones there is only one bell. Shown in Fig. 17 are examples of both single- and double-gong bells.

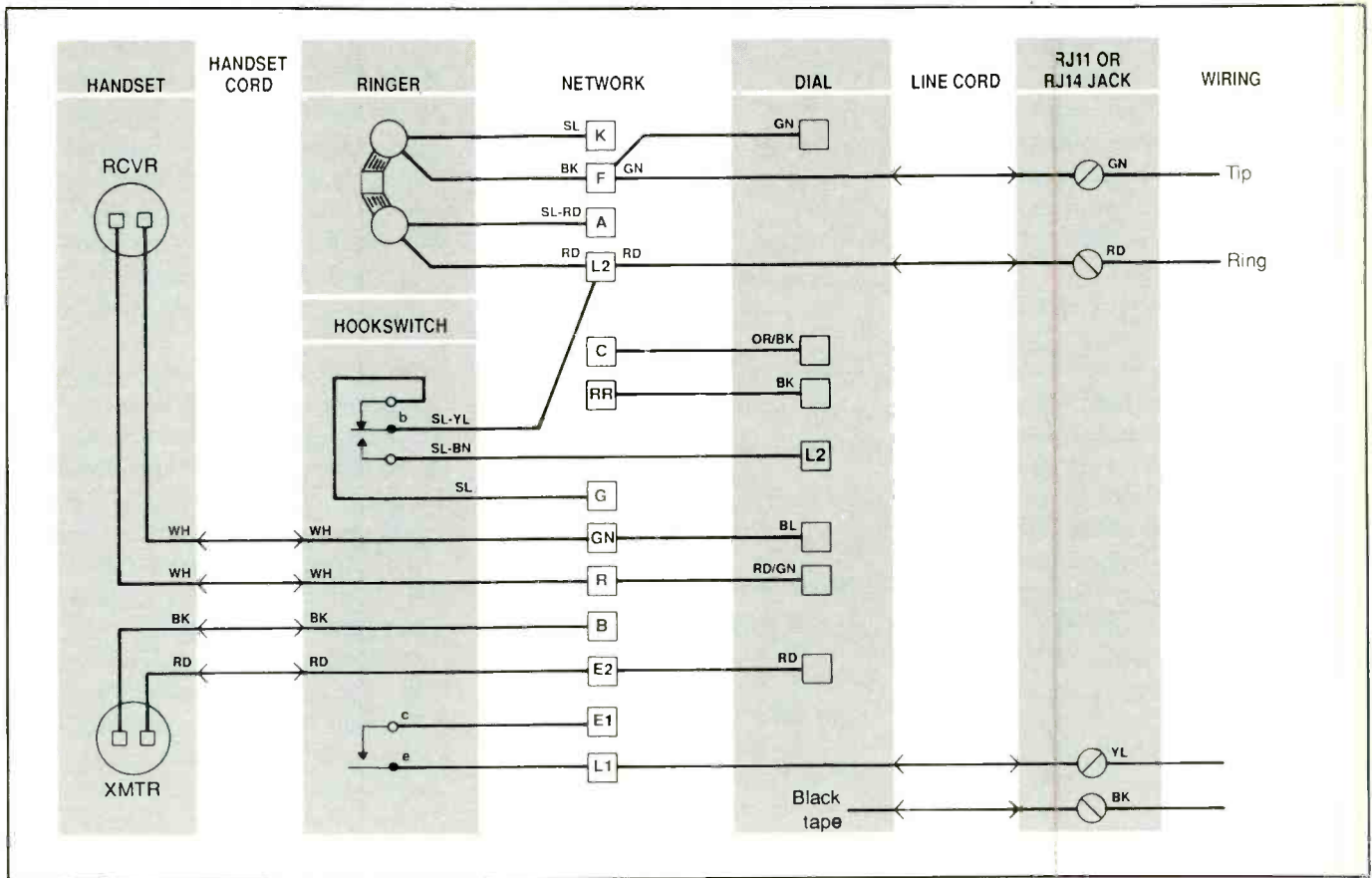

Fig. 16. Network diagram of a typical 2500-type telephone instrument.

Typical standards for ring signals are 90 volts ac rms at a frequency of 20 Hz. There is also a capacitor in series with the coil that blocks dc while passing the ac signal (Fig. 18). Thus, the low impedance of the coil across the tip and ring contacts will not draw dialtone.

Ring failures are almost always confined to the ringer coil itself. It is possible for several windings in the coil to short together such that the coil becomes a less powerful electromagnet. If only a few turns are short-circuited, the incoming ring signal will result in a low ringing of the bells. More severe shorting can result in very low bell-ringing volume or even a barely audible hum or buzz in the most severe short-circuiting cases.

A winding in the coil might also be open (no continuity). In this event, there will be no current-flow path

and the ringer will be totally inoperative. Also, the dc blocking capacitor may become open-circuited so that it will not even pass the ac ring signal.

In more modern telephone instruments, an integrated circuit is used to sense presence of the ring signal and drive a piezoelectric buzzer that audibly alerts you to an incoming call. Very often, the IC fails and will have to be replaced.

• **Noise and Intermittent Operation.** The most common cause of "static" noise in the telephone circuit is in the handset cord. Constant flexing, stretching and twisting of this cord eventually fatigues the internal wiring and connectors. This results in poor and intermittent contact that appears as static in the receiver whenever the handset is moved. Replacing the handset cord will usually cure this condition.

Noise and intermittent operation can be caused by the network assembly as well if any of the soldered points have deteriorated or been damaged. This is usually caused if the telephone instrument has been dropped or subjected to any other sudden severe mechanical shock. You may be able to hear this noise by tapping the body of the instrument.

It is also possible that the network might be slightly cracked. Fortunately, conventional telephone networks are simple assemblies that are very easy to inspect by simple visual means. Thus, it is a simple matter to resolder any questionable connections and bridge any cracks or breaks with a jumper wire.

Another possible contributor to noise can be the hookswitch. The contacts used in a hookswitch are generally very reliable. However, af-

ter years of usage, especially in adverse environments where humidity is high and dust and other airborne contaminants are present, the contact points can corrode and build up oxides and dirt that can cause static noise.

- **Rotary Dial Problems.** Rotary dial mechanisms are prone to wear in all moving parts. When a rotary dial is rotated from its rest position, a set of contacts close to shunt the audio to the receiver. After the dial is released, a spring-driven rotary cam opens and closes another set of contacts at a constant speed of 10 pulses per second (pps).

The pulse ratio, or the ratio of time that the pulse contacts are open to the time they are closed, is 60 percent. For a 100-millisecond pulse length, the contacts are open for 60 milliseconds and closed for 40 milliseconds. Where the wear of the cam or cam shaft may cause the dial to change its pulse ratio, which can cause pulses to be sent that the Central Office cannot interpret correctly.

Wear in the tension spring that returns the dial to its rest position may cause the dial to pulse too fast or too slow during return. Fortunately, pulse speed is not as critical a parameter in proper telephone operation as is the pulse ratio.

- **DTMF Dial Problems.** Dual Tone Multi Frequency dial units used in Touch Tone phones consist of two parts: the mechanical pushbutton keypad assembly and the circuit-board assembly that contains the tone-generating integrated circuit and a frequency base crystal that hold the proper frequencies. DTMF dialers must remain within a *very* tight tolerance, typically 1.5 to 2 percent, for all types of environments and for the entire life of the dialer. The reason that a dual tone is used is so that the Central Office can easily distinguish a dialed digit from speech or other audio that might be fed into the transmitter mouthpiece.

Very little ever goes wrong with a

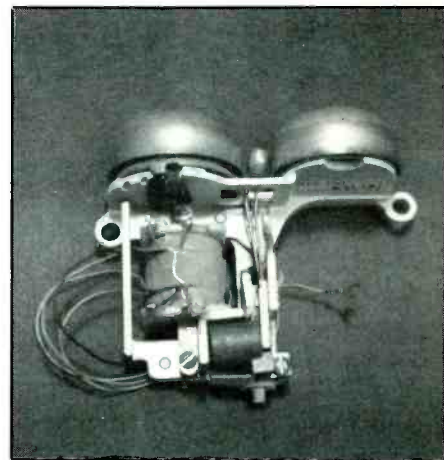
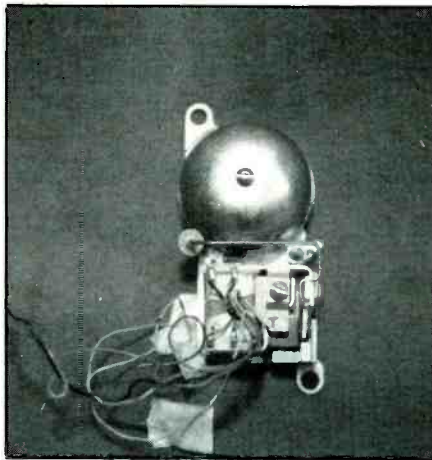

Fig. 17. Examples of single- (A) and dual-gong (B) electromechanical ringers.

DTMF dialer. The most common type of problem is encountering a column or row of buttons that fail to work, caused by one or more bad contacts in the keypad's switch matrix. The next most frequent problem is a total failure in the dial pad such that there is no tone output at all whenever any button is pressed, usually due to a complete failure of the tone-generating IC. In both cases, the DTMF dial unit must be replaced.

Older DTMF dialers use a transistor oscillator with two slug-tuned, multiple-tapped coils to generate the required tones (Fig. 19). When a key is pressed on such a dialer, a set of mechanical contacts along the outside of the dial closes to select the proper taps on each coil to produce the tones for the needed digit.

Mechanical contacts along the outside and in the rear of the DTMF dialer can corrode, eventually resulting in a single-tone or no tone output. The solution to this type of problem is simple: clean the contacts. Use a solvent cleaner designed for electronics use. *Never* use any type of abrasive to clean the contacts; to do so will *destroy* the contacts and accelerate future corrosion.

- **Will Not Break Dialtone.** This is a problem that is inherent in rotary dialers. When the phone is taken off-hook, the Central Office senses loop

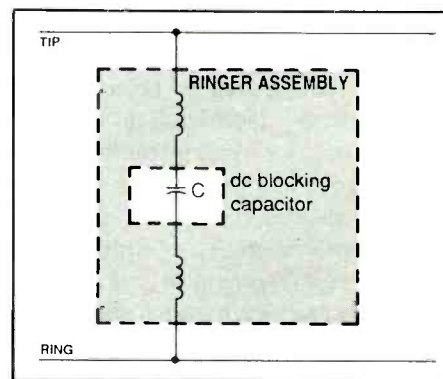

Fig. 18. Typical ringer with dc blocking capacitor.

current and sends a dialtone signal to inform the user that it is ready to receive digits. The moment the Central Office receives the first pulse, it removes the dialtone signal to indicate that it is responding.

If the pulse contacts on a rotary dialer are not making proper contact, no pulses may ever be sent to the Central Office. An easy way to tell if a rotary dialer is not pulsing is to take the instrument off-hook, draw dialtone and briefly tap on the hookswitch. If the dialtone disappears, the Central Office has sensed the pulse sent by the hookswitch. If you obtain this indication, the dialer is probably bad. Cleaning and adjusting the pulse contacts should restore operation.

(Continued on page 98)

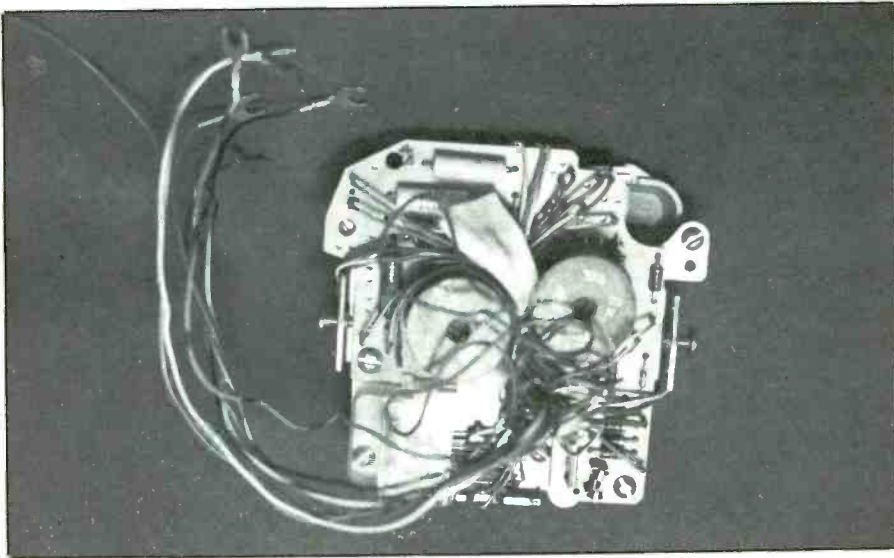

Fig. 19. Component side of 3300 OPG DTMF-type dial pad assembly that uses transistor oscillator circuit and two coils for generating tone-pair frequencies.

• **Low Volume or Distortion.** The handset assembly is virtually always responsible for low volume and distortion in the transmitter or receiver.

The transmitter is usually a carbon microphone in the conventional telephone instrument. It uses a delicate but rigid diaphragm that is tightly

stretched over a capsule packed with carbon granules. The resistance of the capsule changes in step with the frequency and amplitude of the sound pressure it intercepts. It is this change in resistance that varies voice current sent over the phone line.

Over time, the vapor in human breath as well as foreign matter will start to corrode and wrinkle the microphone's diaphragm, loosening its tension. When this occurs, the varying speech current will drop in amplitude and will no longer be a faithful reproducer of the sound entering the microphone. The result is low transmitting volume and/or distortion.

The receiver element works exactly the opposite of the carbon microphone. Varying speech current entering it varies the magnetic field of a small coil wrapped around a permanent magnet that rests behind a delicate metal diaphragm. The varying electromagnetic field vibrates the rigid diaphragm to produce sound energy that is a reproduction of the talker's voice.

Over a period of time, environmental effects and everyday usage will loosen the diaphragm. The result is a loss of volume and intelligibility of the received voice signal.

The solution to a weak transmitter or receiver is to either replace the offending transmitting or receiving element or replace the entire handset assembly.

In Closing

As promised, the Table included here is a quick reference troubleshooting chart that covers the typical problems one can encounter with the telephone discussed here. Modern electronic telephone instruments are slightly more sophisticated than their predecessors, but they still use the same five basic assemblies to perform the same functions. With a little patience and some careful observation, troubleshooting and repair of telephone instruments should become a straightforward task. **ME**

Telephone Instrument Troubleshooting Chart							
Symptoms	Handset Cord	Line Cord	Hook-switch	Dial Unit	Ringer Assembly	Handset Assembly	Network Assembly
Appears Dead (does not activate)	N.A.	X	X	N.A.	N.A.	N.A.	X
Appears Dead (will activate)	X	N.A.	N.A.	N.A.	N.A.	X	X
Low Ring	N.A.	N.A.	N.A.	N.A.	X	N.A.	N.A.
No Ring	N.A.	N.A.	N.A.	N.A.	X	N.A.	X
Noise/Intermittent	X	N.A.	X	N.A.	N.A.	X	X
Single Tone Output	N.A.	N.A.	N.A.	X	N.A.	N.A.	N.A.
No Output Tone	N.A.	N.A.	N.A.	X	N.A.	N.A.	X
Keypad Row Or Column Not Operating	N.A.	N.A.	N.A.	X	N.A.	N.A.	N.A.
Will Not Break Dialtone	N.A.	N.A.	N.A.	X	N.A.	N.A.	N.A.
Low or Garbled Transmit	N.A.	N.A.	N.A.	N.A.	N.A.	X	N.A.
Low or Garbled Receive	N.A.	N.A.	N.A.	N.A.	N.A.	X	N.A.

N.A. = Not applicable; X indicates possible cause.