

IF YOU THOUGHT A MUSIC ON-HOLD feature for your telephone was only for high-budget professionals, think again. We'll show you how you can add FM music on-hold to any analog telephone line with a Touch Tone telephone. It's ideal for home offices or for people who want to project a high-tech appearance.

Some of the features of this design include; LED status indicator, audio volume control, built-in antenna, only one operating adjustment, and a mute function to eliminate "hiss" in between stations. You can build this impressive device in under three hours, for only \$70.

Construction, test, and alignment is made easy due to the use of specialized IC's, namely a single FM receiver chip, IC4, and a DTMF decoder, IC1. There are no special coils to wind, and no tricky circuit adjustments are required. All you need is a DMM to test and align the circuit. Let's now take a look at how the unit works.

#### On-hold circuit

A block diagram of the unit is shown in Fig. 1, and the schematic in Fig. 2. The FM on-hold device connects to an analog telephone line via an RJ11 modular jack. It's powered by an external +15-volt DC, 150-mA power pack that plugs into a standard 120-volt AC outlet. The 15-volt DC supply passes through polarity-protection diode D11 to the input of IC5, a 7812 +12.0-volt DC voltage regulator. Capacitors C24 and C25 provide decoupling and anti-oscillation protection for the regulator. The regulated output of IC5 is fed to the input of IC6, a 78L05 voltage regulator, to provide a 5-volt supply for IC4, a TDA7000 FM receiver. Decoupling and anti-oscillation protection for IC6 is provided by C26. Voltage divider R16-R17 provides the +6-volts DC power-supply output, which is filtered by C28.

When a key on any Touch Tone telephone is depressed, the signal is passed through IC3-d, an LM324N balanced amplifier. The purpose of this amplifier is twofold; it acts as a balanced to unbalanced matching network, and its gain is set to 0.1 to act as a line-voltage attenuator. Capacitors C1 and C2 block the phone

line's 48 volts DC from entering the amplifier. The ringing-voltage is limited by R1 and R2. The ratio of R3 to R1 sets the gain of IC3-d to 0.1. Resistor R4 biases IC3-d between its supply voltage and ground allowing, it to operate from the single +6.0 volts DC power-supply line. The output of the balance amplifier passes through coupling capacitor C3 and is then decoded by IC1, a Motorola MC145436 dual-tone multi-frequency (DTMF) decoder IC.

The output of IC1 is a 4-bit word, whose codes are listed in Table 1. It is connected to IC2-b, a 4082 dual quad-input AND gate, so that the output of that IC (pin 13) is normally low, and goes high only when the "\*" key is pressed. Therefore, when the "\*" key is decoded by IC1, pins 1, 2, and 13 are high while pin 14 is low. To switch the output of IC2-b high, four logic-high inputs must be present. The high inputs are provided by IC1 pins 1, 2, and 13 and IC2-a pin 1.

In order for IC2-a's output to go high, it must also have four logic-high inputs. Two of those are provided by R7, D10, and C27. Those components ensure that the internal power supply is operating. That will prevent the unit from seizing the phone line if power is lost or removed while it is connected to the phone line. The remaining two inputs are provided by a logic high from IC1 pin 12, which is the DV, or DATA VALID, output pin. DV assures proper operation of IC1 by providing internal checks. When those checks are valid, DV will output a logic high. That prevents false triggering due to voice or other tones,

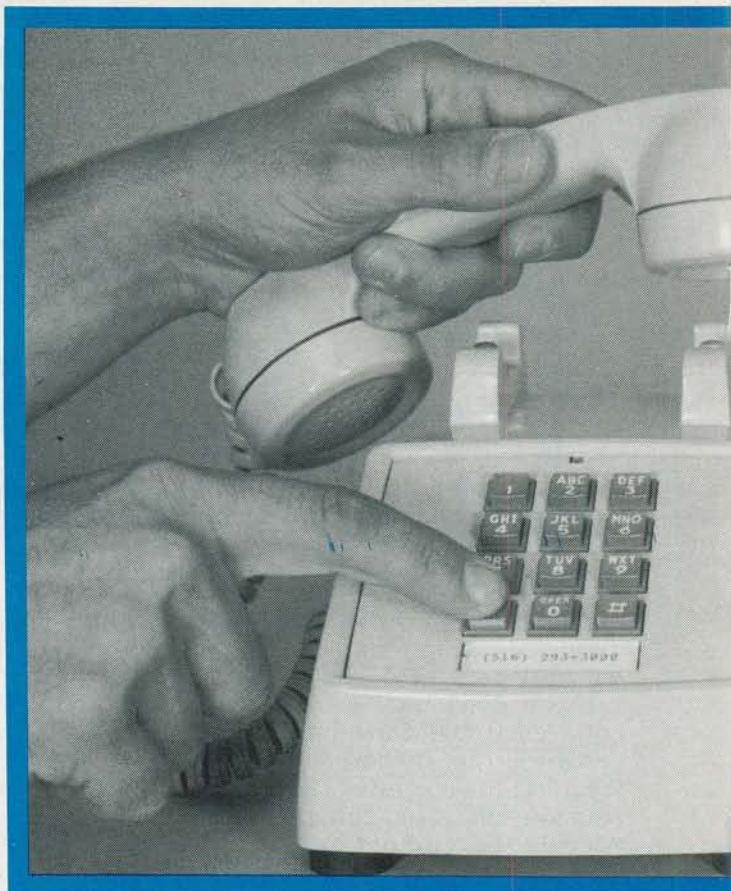

such as music, that occur during normal telephone usage.

When the "\*" key is depressed, IC2-b pin 13 goes high, which in turn charges C4 and turns on switching transistor Q1. That activates relay RY1. Diode D1 prevents DC voltage from bleeding back into IC2-b pin 13. The time-base oscillator for IC1 is formed from a 3.58-MHz crystal XTAL1 and R5.

The normally open contacts of RY1 close and D7, R9, RY2, R10, C5, LED1, transformer T1 (Sec), and the four diodes from the polarity bridge (D3-D6) are connected across the telephone line and effectively "seize" it. That combination of components is referred to as the seizure network. The unit is now in a "standby" mode and LED1 lights dimly. If jumper J1 is in the IN position and a station is tuned in on the FM tuner, that station will be heard on the telephone line. If J1 is in the OUT position, the station will not be heard until the phone is hung up.

RY1 will stay activated for approximately four seconds. That



# MUSIC ON HOLD

PHILLIP HAUSMAN



## Impress your callers by adding an FM music on-hold feature to your telephone.

delay is determined by the RC network of R6-C4. Diode D2 prevents relay-coil induction-induced "spikes" from appearing on the +12-volt DC power-supply line.

If the telephone is hung up within the four-second time-out period, additional loop current will flow through the seizure network and activate RY2. That causes normally open contacts of RY2 to close. The project is now in the "on-hold" mode, LED1 will be brightly lit, and the selected radio station will be heard in the telephone line regardless of the position of jumper J1. After the four-second time-out period, RY1 will deactivate. The loop current flowing through RY2 keeps the seizure network across the telephone line and the unit remains "on-hold."

"normal" mode.

LED1 will not be lit, and the caller will be disconnected if the telephone is hung up.

Latching push-button switch S1 is used to tune in the desired station. When it is in the IN position, the seizure network is placed across the telephone line and the output of the tuner is also connected (regardless of the status of J1). That allows you to hear the output of the FM tuner and adjust the station tuning and volume. (A feature of the receiver is the elimination of interstation "hiss," therefore no audio will be present until a station is tuned in.)

### FM receiver circuit

At the heart of the receiver circuit is IC4, a TDA7000 Signetics FM receiver. This IC has a fre-

quency-locked loop system with an intermediate frequency (IF) of 70 kHz. The IF can be chosen by active RC filters. The only function that needs tuning is the oscillator's resonant circuit, which selects the reception frequency. The antenna is made up from the telephone line and the RJ11 cable. The RF signal travels through that path and is coupled via DC blocking capacitor C6 to the RF input bandpass filter. This broadband low-Q filter consists of C10, C11, and L1. Its primary purpose is to pass RF energy in the 88.0- to 108.0-MHz range while attenuating RF energy from above and below that frequency range. The bandpass filter serves to suppress potential interfering energy from outside the commercial FM broadcast band. The bandpass filter also acts as a split-capacitor (also known as a tapped capacitor) input impedance-matching network to IC4. It matches a 75-ohm RF input impedance to IC4's 1.5K input impedance. The reverse RF input is decoupled by C12. After the RF signal passes through the input bandpass filter, it goes to the input of the internal Gilbert cell mixer where it is mixed with the local oscillator (LO) signal. As mentioned earlier, the frequency of the LO is designed to produce an IF of 70 kHz. The tunable LO, connected between pins 5 and 6 of IC4, consists of tank components L2 and D9. Varactor diode, D9, is DC-voltage tuned by the voltage-divider circuit consisting of R13, R18, and R12. The low end of the tuning range is set by R13 while the high end is set by R12. A high impedance path to the oscillator is provided by R11, keeping it from appearing on the DC tuning control voltage. C21 acts as an RF "short" to ground which prevents the oscillator's RF from entering D9. The IF output of the mixer is routed to a three-stage broadband low-Q IF filter network. The first section (C20 and C19) determines the cut-off frequency for the second-order low-pass IF filter. The second section (C8 and C7) determines the upper and lower passband. The third section (C9) determines the passband of the third section of the low-pass filter network.

quency-locked loop system with an intermediate frequency (IF) of 70 kHz. The IF can be chosen by active RC filters. The only function that needs tuning is the oscillator's resonant circuit, which selects the reception frequency.

The antenna is made up from the telephone line and the RJ11 cable. The RF signal travels through that path and is coupled via DC blocking capacitor C6 to the RF input bandpass filter. This broadband low-Q filter consists of C10, C11, and L1. Its primary purpose is to pass RF energy in the 88.0- to 108.0-MHz range while attenuating RF energy from above and below that frequency range. The bandpass filter serves to suppress potential interfering energy from outside the commercial FM broadcast band.

The bandpass filter also acts as a split-capacitor (also known as a tapped capacitor) input impedance-matching network to IC4. It matches a 75-ohm RF input impedance to IC4's 1.5K input impedance. The reverse RF input is decoupled by C12.

After the RF signal passes through the input bandpass filter, it goes to the input of the internal Gilbert cell mixer where it is mixed with the local oscillator (LO) signal. As mentioned earlier, the frequency of the LO is designed to produce an IF of 70 kHz. The tunable LO, connected between pins 5 and 6 of IC4, consists of tank components L2 and D9.

Varactor diode, D9, is DC-voltage tuned by the voltage-divider circuit consisting of R13, R18, and R12. The low end of the tuning range is set by R13 while the high end is set by R12. A high impedance path to the oscillator is provided by R11, keeping it from appearing on the DC tuning control voltage. C21 acts as an RF "short" to ground which prevents the oscillator's RF from entering D9. The IF output of the mixer is routed to a three-stage broadband low-Q IF filter network.

The first section (C20 and C19) determines the cut-off frequency for the second-order low-pass IF filter. The second section (C8 and C7) determines the upper and lower passband. The third section (C9) determines the passband of the third section of the low-pass filter network.



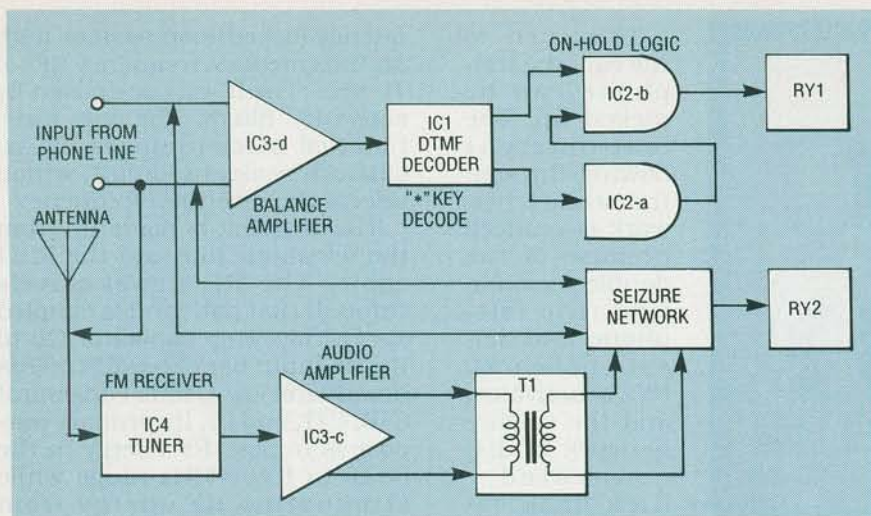

FIG. 1—THIS IS THE BLOCK DIAGRAM of the FM on-hold unit. The circuit consists of three basic sections; a DTMF decoder/on-hold logic, seizure network, and an FM receiver.

After the signal is passed through the IF filter section, it is demodulated. The quadrature detector is tuned by C14. The frequency-locked loop (FLL) filter, which suppresses IF harmonics and prevents them from appearing at the output of the demodulator, is controlled by C18.

The demodulated audio signal from pin 2 passes through a deemphasis network consisting

of C22 and R14. A load for the audio output current source is also provided by R14.

The audio signal passes through C23 and R15 to the inverting input of audio amplifier IC3-c. Feedback resistor R19 controls the gain of the amplifier from 0 to 10. Transformer T1 matches the amplifier's output impedance to the telephone line impedance.

TABLE 1—DTMF DECODER OUTPUT CODES

Digit	D8	D4	D2	D1
1	0	0	0	1
2	0	0	1	0
3	0	0	1	1
4	0	1	0	0
5	0	1	0	1
6	0	1	1	0
7	0	1	1	1
8	1	0	0	0
9	1	0	0	1
*	1	0	1	1
#	1	1	0	0
A	1	1	0	1
B	1	1	1	0
C	1	1	1	1
D	0	0	0	0

### Construction

The author's prototype is shown in Fig. 3. The entire FM on-hold circuit is mounted on one double-sided PC board. The use of a single-sided board will work as long as the jumper wires are added to the top where necessary. We recommend that a PC board be used because of the VHF range involved in this project. We have provided foil patterns of the

### PARTS LIST

#### All resistors are 1/4-watt, 5%.

R1, R2, R11—100,000 ohms  
 R3, R4, R7, R13, R15—10,000 ohms  
 R5—1 Megohm  
 R6—39,000 ohms  
 R8—2000 ohms  
 R9—2700 ohms  
 R10—1200 ohms  
 R12—130,000 ohms  
 R14—20,000 ohms  
 R16, R17—470 ohms  
 R18, R19—100,000 ohms horizontal PC-mounted potentiometer

#### Capacitors. All are 50 volts DC, 10% tolerance, mono or ceramic disc unless otherwise indicated.

C1, C2, C6—0.022  $\mu$ F, 250 WVDC, 20% tolerance  
 C3, C13, C17, C23—C26—0.1  $\mu$ F  
 C4, C27—10  $\mu$ F, 10 volts, 20% tantalum  
 C5—47  $\mu$ F, 63 volts, 20% electrolytic  
 C7, C20, C21—3300 pF, 50 volts  
 C8, C14—330 pF  
 C9—150 pF  
 C10, C11—39 pF ceramic disc  
 C12, C22—2200 pF  
 C15—220 pF  
 C16, C18, C29—0.01  $\mu$ F, 20%  
 C19—180 pF

C28—100  $\mu$ F, 25 volts, 20% electrolytic

#### Semiconductors

D1—D7, D10, D11—1N4003, 1 amp 200 PIV rectifier diode  
 D8—not used  
 D9—MV209 varactor diode (Motorola)  
 LED1—Red LED  
 IC1—MC145436 DTMF decoder (Motorola)  
 IC2—4082 dual 4-Input AND gate  
 IC3—LM324N quad op-amp  
 IC4—TDA7000 FM Receiver (Signetics-Philips)  
 IC5—7812 +12-VDC, 1-amp regulator  
 IC6—78L05 +5-VDC, 0.1-amp regulator  
 Q1—MPSA13 NPN Darlington transistor

#### Other components

L1—0.138  $\mu$ H fixed inductor (Coilcraft no. 132-09 or 9T no. 24 1/8 -inch ID)  
 L2—0.060  $\mu$ H shielded variable inductor (Coilcraft no. 150-02J08S or TOKO no. MC122)  
 RY1, RY2—DPDT relay 12 VDC (Aromat no. DS2YE-S-DC12)

T1—audio transformer, 500-ohm primary, 200-ohm secondary (Mouser no. 42TM002)

S1—DPDT latching push button switch

XTAL1—3.58-MHz parallel resonant crystal, HC-18/U case

J1—0.1-inch single inline jumper bar and strap

**Miscellaneous:** Male power jack, female PC board-mounted lug receptacles, 117-VAC power pack (15 VDC at 150 mA), PC board, 6-foot modular line cord, male RJ11 to lugs, project case (Builder's Choice), and 3 14-pin IC sockets

**Note:** The following items are available from HESC Inc., P.O. Box 12649, Fort Wayne, IN 46864-2649, (219) 482-7190:

- A complete kit of parts including PC board, all components, machined plastic case, and power pack—\$69.95 + \$3.00 S&H.

- An assembled and tested unit—\$119.95 + \$3.00 S&H.

Send check or money order, IN residents add 5% sales tax. Allow 6-8 weeks for delivery.



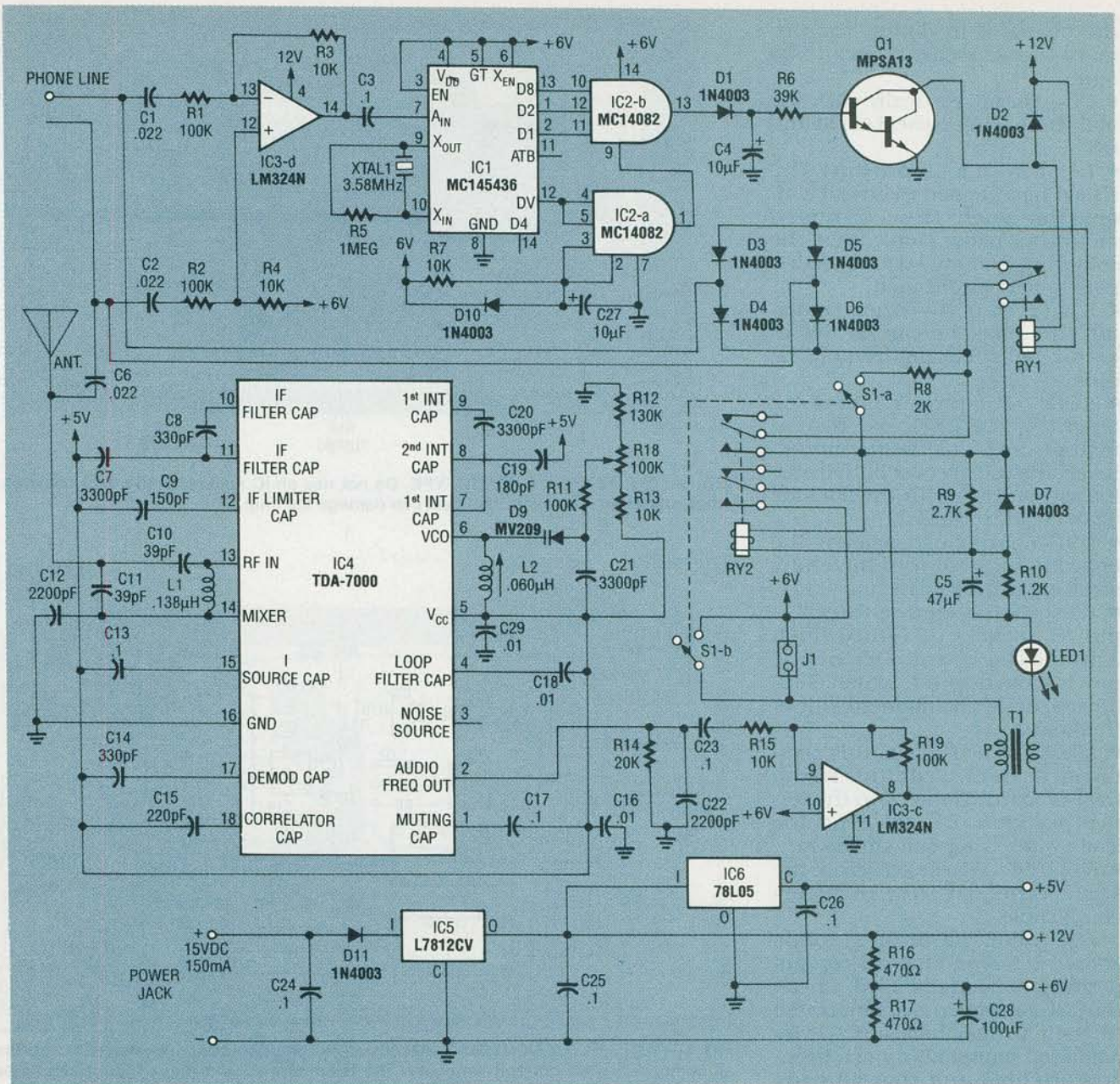

FIG. 2—SCHEMATIC OF THE FM ON-HOLD unit. The output of IC1, a DTMF decoder, is a 4-bit word that controls the on-hold logic. The FM receiver, IC4, uses a frequency-locked loop system with a 70-kHz intermediate frequency, which is tuned by a tank circuit consisting of L2 and D9. Spurious reception is eliminated by a mute circuit in the IC.

component side and solder side of the PC board if you wish to make it yourself. If you choose not to use a PC board, the use of a prototype style board is recommended. You should note that the use of wire wrapping will not work for the receiver portion of this project due to ground return path impedance problems. You can use IC sockets for all IC's except IC4, the TDA7000 FM receiver. The use of an IC socket at VHF frequencies should be avoided.

Figure 4 shows the parts-place-

ment diagram of the unit. Before you begin construction, there are a few things to keep in mind:

- Use proper soldering techniques—The importance of proper soldering cannot be emphasized enough for VHF circuits. We recommend that the flux residue be removed from the completed PC board using a mild non-CFC cleaner that's not harmful to plastics. Always read the manufacturer's label.
- Static sensitive devices—Observe electrostatic discharge precautions when handling individ-

ual semiconductors as well as the completed circuit board.

- Component leads—Pre-form component leads before installing them in the board.
- Non-polarized capacitors—When installing these components, orient them so their values can easily be read. This will help if troubleshooting is needed later on.
- Resistors—Mount resistors so they can be read from left to right and top to bottom. This also aids in troubleshooting.
- T1—Bend the tabs flush against the PC board. The audio transformer has a "P" indicating the primary side. The primary mounts towards the outside of



the board. If in doubt, the primary should measure about 500 ohms.

- C6—Mount vertically with the body in the hole closest to D4 and D6.

- L1, L2—It's important the shield have a good electrical connection with the PC board mounting pads. Don't leave the soldering iron on too long as this plastic part might melt.

- IC4 (TDA7000)—When soldering this chip, be careful not to keep a hot soldering iron on the pins too long.

- LED1—For proper mounting height of the LED, cut two 1/2-inch pieces of insulating tubing. Insert the tubing over both leads. Install the LED with the flat side (short lead) toward T1.

- D9—Mount flush against the board. That will minimize any stray capacitance effects.

- IC sockets—Mount three 14-pin IC sockets (IC1-IC3) flush against the board. Orient the notch towards pin 1, which is indicated on the component side of the board.

- XTAL1—The leads of this crystal can be connected either way to the PC board. Mount it in the vertical position. Do not bend the leads where they exit the body.

- RY1, RY2—These relays are the same type, so they're interchangeable.

The following pre-test steps should be done after all components have been installed. Check that all components are mounted in their proper location. Verify polarized components are properly oriented and that all pads and connections have been properly soldered and de-fluxed. Once those steps have been completed, you can begin bench testing.

### Testing and alignment

The only instrument needed to test the unit is a DMM. Connect the power pack (or a +15- to +28-volt DC power source) to the DC input. Connect AC power to the power pack. Don't connect the unit to the phone line at this time. Next, verify proper operation by making the check out measurements indicated in Table 2. After you have made those measurements, you can proceed with the alignment.

You'll need a plastic alignment tool, a signal source in the FM

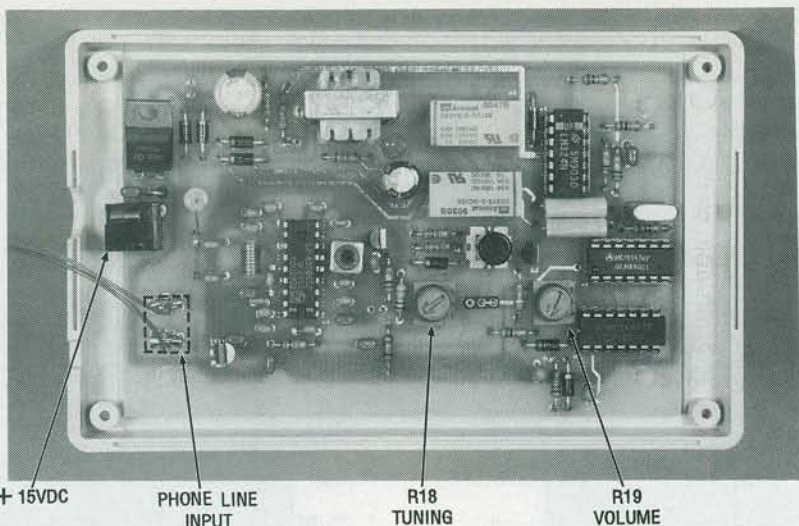

FIG. 3—THE AUTHOR'S PROTOTYPE. Do not use an IC socket for IC4, and be careful when soldering it as excessive heat can damage the chip.

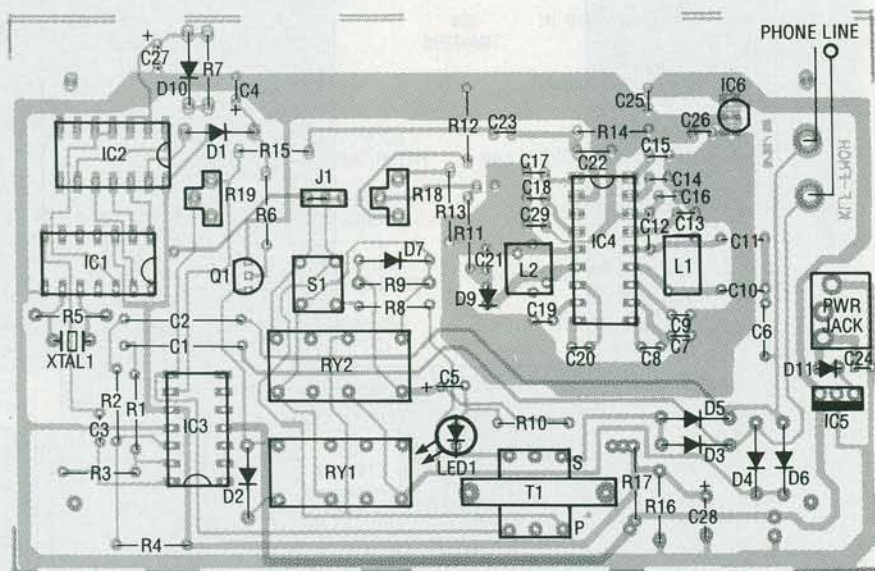

FIG. 4—PARTS-PLACEMENT DIAGRAM. Install all components as shown here. Make sure all components are correctly oriented. The telephone tip and ring conductors can be connected at either phone-line input.

broadcast band, and a method to hear the audio output. The simplest way of aligning the unit is to connect it to the phone line. The unit was designed to not be sensitive to the tip and ring polarities. Therefore, it doesn't matter which phone lead connects to which terminal on the PC board.

Once the phone line is connected, dial your own number to eliminate the signal tone and off-hook warning tone. Turn the receiver on by depressing push button switch S1. Set the tuning potentiometer to the extreme counter clockwise position (low end of the band). Note that due to the mute function, there is si-

lence until a station is received.

Turn the volume control potentiometer 1/2 and 3/4 clockwise. Adjust the slug in L2 until the station operating at the lowest dial setting in your area is received with the loudest audio output. Use care when adjusting the slug as it is quite delicate and can easily be broken.

Next, set the tuning potentiometer to the extreme clockwise position (top end of the band). Tune back down towards the bottom end of the band (counter clockwise) until the station operating at the highest frequency is received.

Tune through the entire range



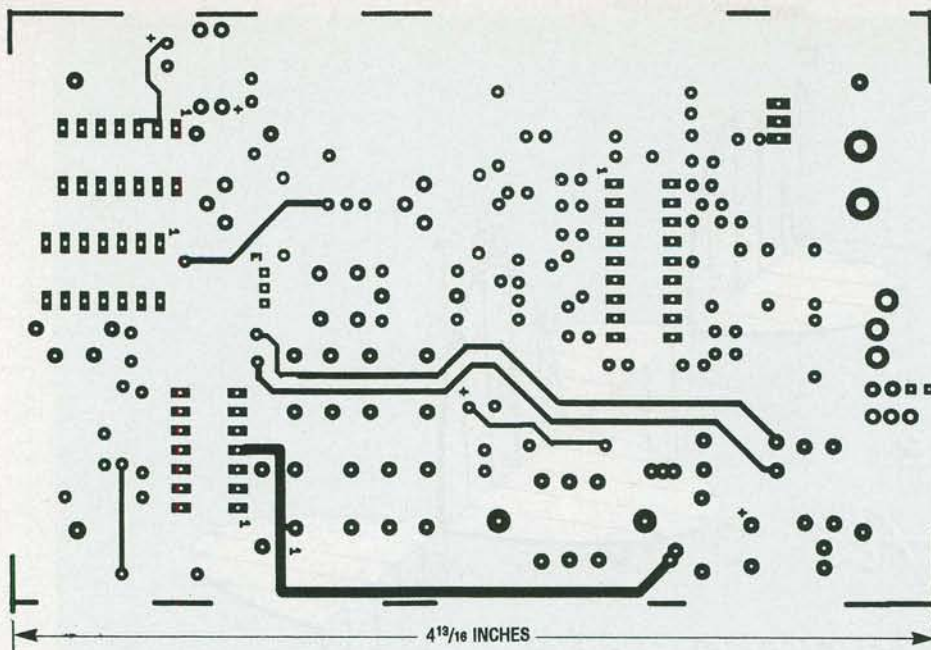

COMPONENT SIDE foil pattern shown actual size.

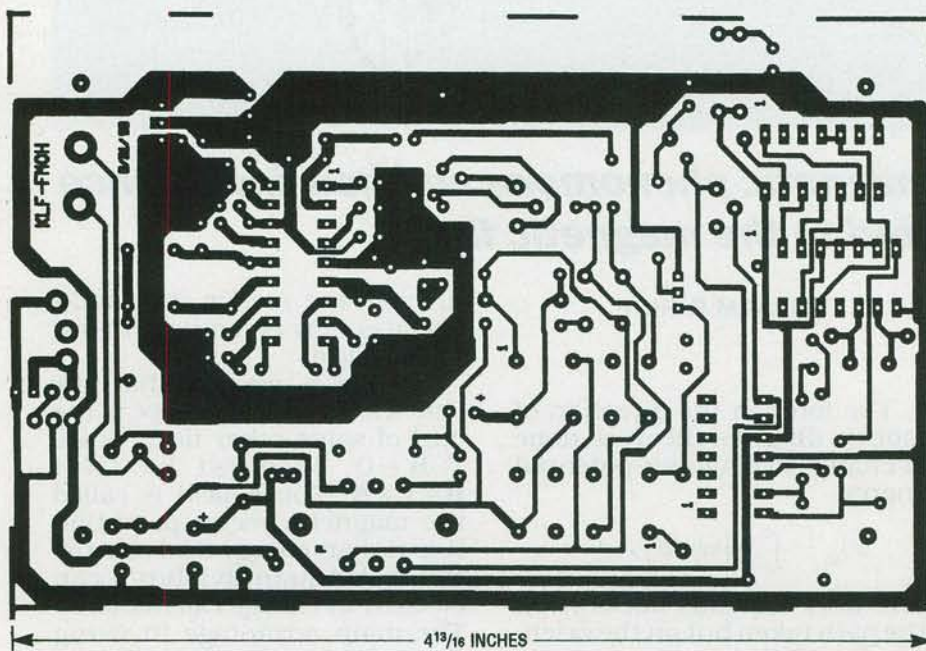

SOLDER SIDE foil pattern shown actual size.

TABLE 2—CHECKOUT MEASUREMENTS

Parameter	Low Limit	High Limit	Actual Reading
Output of Power Pak	+ 13.50	+ 28.00	_____VDC
Input Current	31.00	34.00	_____mA
IC5 output	+ 11.40	+ 12.60	_____VDC
IC6 output	+ 4.75	+ 5.25	_____VDC
+ 6.0 VDC output	+ 4.50	+ 6.50	_____VDC
IC3-d pin 12	+ 4.50	+ 6.50	_____VDC
IC2-a pin 2	+ 4.50	+ 6.50	_____VDC
IC1 pin 3	+ 4.50	+ 6.50	_____VDC
IC2-b pin 14	+ 4.50	+ 6.50	_____VDC
IC3-c pin 10	+ 4.50	+ 6.50	_____VDC
IC3-d pin 4	+ 11.40	+ 12.60	_____VDC

to verify all stations available to your area are being received. The receiver section was designed with a mute function built-in to allow only the strongest stations to be received. That makes tuning easier and suppresses images ("ghost" stations that appear in the wrong part of the tuning dial). Release the push-button and hang up the phone.

You can check for proper operation by having a friend call and be placed on hold by depressing the star "\*" key (LED1 lights dimly) and then hanging up the phone.

### Installation and use

A special feature of this project allows you to select when the music is present in the handset. Some telephone services (call waiting, call forwarding, voice mail) require the use of the "\*" key. With J1 in the OUT position (circuit open), music will not be heard in the handset when the "\*" key is depressed. It will, however, be heard by the caller when the phone is hung up. With J1 in the IN position (circuit closed), music will be heard every time the "\*" key is depressed. Install the jumper according to your available service requirements.

If you would like to connect an external antenna or RF source, such as cable, to the tuner, you can connect it to the junction of C6, C10, and C11. It may be advantageous to disconnect the phone-line antenna by breaking the connection at C6.

It's easy to use the FM on-hold unit. To place a caller on hold press the star "\*" key on any Touch Tone telephone. That places the unit in a standby mode and the LED lights dimly. The telephone must be hung up within four seconds for the caller to be placed on hold. When that's done, the LED lights brightly. If it's not hung up within 4 seconds, the unit resets itself and the LED goes out. The caller will be disconnected if the phone is hung up.

After a caller has been placed on hold, all you have to do is pick up the telephone to return to the conversation (any telephone connected to the line, Touch Tone or rotary). When the handset is picked up, the brightly lit LED will extinguish, the music will go off, and you will be connected to the caller.

R-E