

# DR-510T/E

## Service Manual

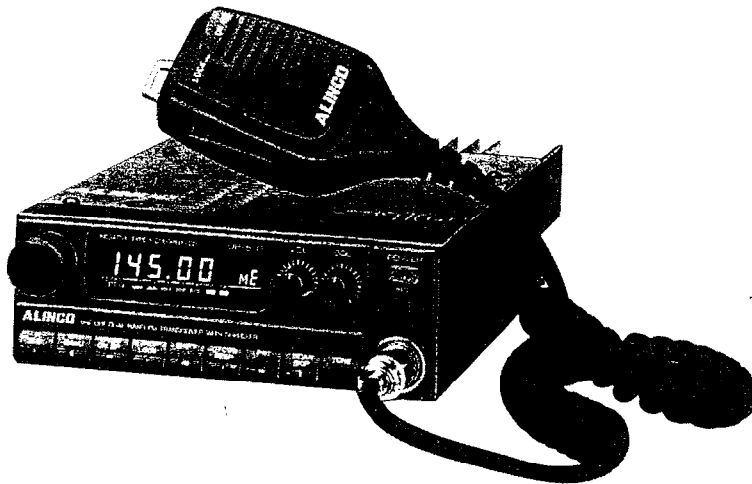

### Index

● SPECIFICATION .....	2	● CTCSS SCHEMATIC DIAGRAM .....	29
● PARTS LIST .....	3~9	● TONE SQUELCH PC BOARD .....	30
● CABINET PARTS LOCATION .....	10	● X'CON PC BOARD .....	31
● ADJUSTMENT (VHF) .....	11	● TONE BURST PC BOARD .....	32
● ADJUSTMENT (UHF) .....	12	● APC PC BOARD .....	32
● BLOCK DIAGRAM .....	13	● VHF VCO PC BOARD .....	33
● CONNECTION DIAGRAM .....	14	● UHF VCO PC BOARD .....	33
● VHF MAIN SCHEMATIC DIAGRAM .....	15~17	● SQUELCH PC BOARD .....	34
● UHF MAIN SCHEMATIC DIAGRAM .....	18~20	● X'CON-SUB PC BOARD .....	34
● PA SCHEMATIC DIAGRAM .....	21	● EARPHONE JACK PC BOARD .....	34
● VHF PA AND MAIN PC BOARD .....	22, 23	● VHF DRIVE PC BOARD .....	35
● UHF PA AND MAIN PC BOARD .....	24, 25	● UHF DRIVE PC BOARD .....	35
● CONTROL SCHEMATIC DIAGRAM .....	26	● IF PC BOARD .....	35
● CONTROL PC BOARD .....	27	● RX SW PC BOARD .....	36
● DUPLEXER SCHEMATIC DIAGRAM .....	28	● MIC PC BOARD .....	36
● DUPLEXER PC BOARD .....	28	● LOCK SW PC BOARD .....	36

**ALINCO ELECTRONICS INC.**

# PECIFICATIONS

## eneral

Frequency Coverage	144.0~148.0 MHz (DR-510T) 440.0~450.0 MHz 144.0~146.0 MHz (DR-510E) 430.0~440.0 MHz
Antenna Impedance	50 ohms unbalanced
Power Supply Requirement	13.8 Volts D.C.
Current Drain at 13.8 V	Receiving Squelched: does not exceed 500 mA Transmitting High: 45 W approx. 9.5 A at VHF 35 W approx. 10 A at UHF Low: 5 W approx. 4 A at VHF 5 W approx. 4 A at UHF
Dimensions	140 mm (W) × 50 mm (H) × 205 mm (D) (5½" × 2" × 8¼")
Weight	Approx. 1.7 kgs. (3.75 lbs.)

## ransmitter

Output Power	High; 45 Watts at VHF, 35 Watts at UHF Low; Approx. 5 Watts at both bands
Modulation Mode	16F3
Excitation System	Variable Reactance F.M.
Frequency Deviation	±5 kHz
Spurious Emission	More than 60 dB below carrier
Microphone	Electret Condenser Microphone
Operating Mode	Simplex Duplex: ±600 kHz from receive frequency at VHF ±5, 1.6, 7.6 MHz from receive frequency at UHF (Odd offsets programmable)
Frequency Encoder	Built-in

## Receiver

Operating System	Superhetrodyne, dual conversion
Modulation Acceptance	16F3
Intermediate Frequency	1st 10.7 MHz 2nd 455 kHz at VHF 1st 30.825 MHz 2nd 455 kHz at UHF
Sensitivity	12 dB SINAD less than 0.16 μV
Selectivity	More than ±6 kHz at -6 dB Less than ±12 kHz at -60 dB
Power Output	More than 1.5 Watts (8 ohms-10% Distortion)
Speaker Impedance	8 ohms

# PARTS LIST

Ref. No.	Part Code	Part Name and Number	Ref. No.	Part Code	Part Name and Number	Ref. No.	Part Code	Part Name and Number
<b>UHF Drive Unit</b>								
R7	RK0018	Chip R, MCR10EZHZ101E	R43	RK0045	Chip R, MCR10EZHZ472E	R136	RD0018	R. 1/4 W 100Ω R20
R8	RK0035	Chip R, MCR10EZHZ102E (DR-510T only)	R44	RK0005	Chip R, MCR10EZHZ220E	R137	RD0116	R. R20 R02 J1R0
R8	RK0048	Chip R, MCR10EZHZJ682F (DR-510E only)	R45	RK0045	Chip R, MCR10EZHZ472E	R138	RK0062	Chip R, MCR10EZHZ473E
R9	RK0105	Chip R, MCR10EZHZJ2R2E (DR-510T only)	R46	RK0062	Chip R, MCR10EZHZ473E	R140	RK0052	Chip R, MCR10EZHZ103E
R9	RK0011	Chip R, MCR10EZHZJ470E (DR-510E only)	R47	RK0062	Chip R, MCR10EZHZ473E	R141	RK0035	Chip R, MCR10EZHZ102E
R10	RK0011	Chip R, MCR10EZHZJ470E	R48	RK0062	Chip R, MCR10EZHZ473E	R142	RK0035	Chip R, MCR10EZHZ102E
R11	RK0042	Chip R, MCR10EZHZJ332E	R49	RK0062	Chip R, MCR10EZHZ473E	C1	CU0011	Chip C, C2012CH1H100D
R12	RK0031	Chip R, MCR10EZHZJ681E	R50	RK0062	Chip R, MCR10EZHZ473E	C2	CU0004	Chip C, C2012CH1H030C
R13	RK0011	Chip R, MCR10EZHZJ470E	R51	RK0018	Chip R, MCR10EZHZ101E	C3	CU0035	Chip C, C2012CH1H101K
R14	RK0005	Chip R, MCR10EZHZ220E	R52	RK0052	Chip R, MCR10EZHZ103E	C4	CU8016	Chip C, C2012B1H102K
R17	RK0035	Chip R, MCR10EZHZ102E (DR-510T only)	R53	RK0056	Chip R, MCR10EZHZ223E	C5	CU8016	Chip C, C2012B1H102K
R17	RK0062	Chip R, MCR10EZHZJ473E (DR-510E only)	R54	RK0035	Chip R, MCR10EZHZ102E	C6	CU0035	Chip C, C2012CH1H101K
R18	RK0018	Chip R, MCR10EZHZJ101E (DR-510T only)	R55	RK0062	Chip R, MCR10EZHZ473E	C7	CU0002	Chip C, C2012CH1H010C
R18	RK0028	Chip R, MCR10EZHZJ471E (DR-510E only)	R56	RK0062	Chip R, MCR10EZHZ473E	C8	CU8016	Chip C, C2012B1H102K
Q4	XT0030	Transistor, 2SC3356T1 (DR-510T only)	R57	RK0062	Chip R, MCR10EZHZ473E	C9	CU0025	Chip C, C2012CH1H390K
Q4	XT0074	Transistor, 2SC2759T1 (DR-510E only)	R58	RK0022	Chip R, MCR10EZHZ221E	C10	CU8016	Chip C, C2012B1H102K
Q5	XT0030	Transistor, 2SC3356T1 (DR-510T only)	R59	RK0052	Chip R, MCR10EZHZ103E	C11	CU8016	Chip C, C2012B1H102K
Q5	XT0074	Transistor, 2SC2759T1 (DR-510E only)	R60	RK0038	Chip R, MCR10EZHZ182E	C12	CU8016	Chip C, C2012B1H102K
L1	QC0018	Coil K3002 12NH	R61	RK0050	Chip R, MCR10EZHZ822E	C13	CU8016	Chip C, C2012B1H102K
L2	QC0018	Coil K3002 12NH	R62	RK0038	Chip R, MCR10EZHZ182E	C14	CU0003	Chip C, C2012CH1H020C
C3	CV8016	Chip C, C2012B1H102K	R63	RK0079	Chip R, MCR10EZHZ474E	C15	CU0023	Chip C, C2012CH1H390K
C4	CV8016	Chip C, C2012B1H102K	R64	RK0052	Chip R, MCR10EZHZ103E	C16	CU8016	Chip C, C2012B1H102K
C5	CV8016	Chip C, C2012B1H102K	R66	RK0052	Chip R, MCR10EZHZ103E	C17	CU0035	Chip C, C2012CH1H101K
C6	CV0064	Chip C, C2012B1H220J	R67	RK0056	Chip R, MCR10EZHZ223E	C18	CU8016	Chip C, C2012B1H102K
C7	CV8016	Chip C, C2012B1H102K	R68	RK0035	Chip R, MCR10EZHZ102E	C19	CU8016	Chip C, C2012B1H102K
C8	CV0051	Chip C, C2012CH1H471K	R69	RK0018	Chip R, MCR10EZHZ101E	C20	CU0008	Chip C, C2012CH1H070D
C9	CV0051	Chip C, C2012CH1H471K	R70	RK0045	Chip R, MCR10EZHZ472E	C21	CU0035	Chip C, C2012CH1H101K
C10	CV8016	Chip C, C2012B1H102K	R71	RK0039	Chip R, MCR10EZHZ222E	C22	CU8028	Chip C, C2012B1H103K
C11	CS0049	Chip Tantal, TMC1C105TR	R72	RK0018	Chip R, MCR10EZHZ101E	C23	CU8028	Chip C, C2012B1H103K
			R73	RK0035	Chip R, MCR10EZHZ102E (DR-510E only)	C24	CU8028	Chip C, C2012B1H103K
			R74	RK0039	Chip R, MCR10EZHZ222E	C25	CU8016	Chip C, C2012B1H102K
			R75	RK0106	Chip R, MCR10EZHZ3R3E	C26	CU0016	Chip C, C2012CH1H150K
			R76	RK0018	Chip R, MCR10EZHZ101E	C27	CU0029	Chip C, C2012CH1H560K
			R77	RK0022	Chip R, MCR10EZHZ221E	C28	CE0064	Chemical C, 10 V 47 μF MS9
			R79	RK0031	Chip R, MCR10EZHZ681E	C29	CE8028	Chemical C, B1H103K
			R81	RK0106	Chip R, MCR10EZHZ3R3E	C30	CE8016	Chemical C, B1H102K
			R82	RK0062	Chip R, MCR10EZHZ473E	C31	CE0030	Chemical C, 16 V 10 μF MS7
			R83	RK0062	Chip R, MCR10EZHZ473E	C33	CU8028	Chip C, C2012B1H103K
			R85	RK0020	Chip R, MCR10EZHZ151E	C34	CE0064	Chemical C, 10 V 47 μF MS9
			R86	RK0038	Chip R, MCR10EZHZ182E	C35	CE0121	Chemical C, 10 V 100 μF MS7
			R87	RK0107	Chip R, MCR10EZHZ000E (DR-510T only)	C36	CU8003	Chemical C, JF1E104Z
			R87	RK0128	Chip R, MCR10EZHZ5R6E (DR-510E only)	C38	CU8016	Chip C, C2012B1H102K
			R88	RK0022	Chip R, MCR10EZHZ221E	C39	CU8016	Chip C, C2012B1H102K
			R89	RK0107	Chip R, MCR10EZHZ000E (DR-510T only)	C40	CE0064	Chemical C, 10 V 47 μF MS9
			R89	RK0128	Chip R, MCR10EZHZ5R6E (DR-510E only)	C41	CU8007	Chemical C, JF1H473Z
			R90	RK2008	Chip R, MCR10EZHZ220E	C42	CE0064	Chemical C, 10 V 47 μF MS9
			R91	RK0069	Chip R, MCR10EZHZ104E	C44	CU8038	Chip C, CM316Y5V105Z25VAT
			R92	RK0069	Chip R, MCR10EZHZ104E	C45	CU8016	Chip C, C2012B1H102K
			R95	RK0035	Chip R, MCR10EZHZ102E	C46	CE0149	Chemical C, 10 V 220 μF SSP
			R96	RK0035	Chip R, MCR10EZHZ102E	C47	CE8028	Chemical C, 103K
			R97	RK0052	Chip R, MCR10EZHZ103E	C48	CS0064	Chip Tantal C, TMC1A155TR
			R99	RK0079	Chip R, MCR10EZHZ474E	C49	CE0064	Chemical C, 10 V 47 μF MS9
			R100	RK0062	Chip R, MCR10EZHZ473E	C50	CE8028	Chemical C, 103K
			R101	RK0039	Chip R, MCR10EZHZ222E	C51	CE0019	Chemical C, CH1H220K
			R102	RK0035	Chip R, MCR10EZHZ102E	C52	CE8028	Chemical C, 103K
			R106	RK0069	Chip R, MCR10EZHZ104E	C53	CE0043	Chemical C, CH1H221K
			R107	RK0039	Chip R, MCR10EZHZ222E	C54	CE0035	Chemical C, CH1H101K
			R108	RK0062	Chip R, MCR10EZHZ473E	C55	CU8016	Chip C, C2012B1H102K
			R115	RK0076	Chip R, MCR10EZHZ334E	C56	CU0035	Chip C, C2012CH1H101K
			R116	RK0076	Chip R, MCR10EZHZ334E	C57	CU8032	Chip C, C2012CH1H223K
			R119	RK0056	Chip R, MCR10EZHZ223E	C58	CU8032	Chip C, C2012CH1H223K
			R120	RK0057	Chip R, MCR10EZHZ273E	C59	CS0064	Chip Tantal C, TMC1A155TR
			R123	RK0045	Chip R, MCR10EZHZ472E	C60	CQ0008	Film C, 50F2M683K
			R125	RK0056	Chip R, MCR10EZHZ223E	C61	CU8016	Chip C, C2012B1H102K
			R126	RK0107	Chip R, MCR10EZHZ000E	C62	CQ0008	Film C, 50F2M683K
			R127	RK0056	Chip R, MCR10EZHZ223E	C63	CQ8028	Film C, 50F2M103K
			R128	RK0052	Chip R, MCR10EZHZ103E	C64	CS0049	Chip Tantal C, TMC1C105TR
			R130	RK0052	Chip R, MCR10EZHZ103E	C65	CS8028	Chip Tantal C, TMC1C103K
			R131	RK0052	Chip R, MCR10EZHZ103E	C66	CU8016	Chip C, C2012B1H102K
			R133	RK0056	Chip R, MCR10EZHZ223E	C67	CU8028	Chip C, C2012B1H103K
			R134	RK0107	Chip R, MCR10EZHZ000E	C68	CE0149	Chemical C, 10 V 220 μF SSP
			R135	RK0039	Chip R, MCR10EZHZ222E	C69	CE8028	Chemical C, 103K
						C70	CE0149	Chemical C, 10 V 220 μF SSP
						C71	CE0003	Chemical C, CH1H020C
						C72	CE0007	Chemical C, CH1H060D (DR 510E only)
<b>UHF Main Unit</b>								
R1	RK0056	Chip R, MCR10EZHZ223E						
R2	RK0056	Chip R, MCR10EZHZ223E						
R3	RK0069	Chip R, MCR10EZHZ104E						
R4	RK0018	Chip R, MCR10EZHZ101E						
R5	RK0018	Chip R, MCR10EZHZ101E						
R6	RK0011	Chip R, MCR10EZHZ470E						
R7	RK0106	Chip R, MCR10EZHZ3R3E						
R8	RK0005	Chip R, MCR10EZHZ220E						
R12	RK0022	Chip R, MCR10EZHZ221E						
R13	RK0011	Chip R, MCR10EZHZ470E						
R15	RK0062	Chip R, MCR10EZHZ473E						
R16	RK0052	Chip R, MCR10EZHZ103E						
R17	RK0028	Chip R, MCR10EZHZ471E						
R18	RK0020	Chip R, MCR10EZHZ151E						
R19	RK0018	Chip R, MCR10EZHZ101E						
R20	RK0052	Chip R, MCR10EZHZ103E						
R21	RK0106	Chip R, MCR10EZHZ3R3E						
R24	RK0059	Chip R, MCR10EZHZ333E						
R26	RK0035	Chip R, MCR10EZHZ102E						
R28	RK0035	Chip R, MCR10EZHZ102E						
R29	RK0035	Chip R, MCR10EZHZ102E						
R31	RK0035	Chip R, MCR10EZHZ102E						
R33	RK0039	Chip R, MCR10EZHZ222E						
R35	RK0069	Chip R, MCR10EZHZ104E						
R38	RK0052	Chip R, MCR10EZHZ103E						
R40	RK0052	Chip R, MCR10EZHZ103E						
R41	RK0038	Chip R, MCR10EZHZ182E						
R42	RK0005	Chip R, MCR10EZHZ220E						

Part Code	Part Name and Number	Ref. No.	Part Code	Part Name and Number	Ref. No.	Part Code	Part Name and Number
CU0015	Chip C, C2012CH1H150K (DR-510T only)	L1	QA0050	Coil 5x5 1/4 T	R2	RK0052	Chip R, MCR10EZHU103E
CE0004	Chemical C, CH1H030C (DR-510E only)	L2	QA0036	Coil 3x1.5 T	R3	RK0056	Chip R, MCR10EZHU223E
CU8016	Chip C, C2012B1H102K	L3	QA0061	Coil 110-7H2-440C	R4	RK0018	Chip R, MCR10EZHU101E
CU0019	Chip C, C2012CH1H220K	L4	QA0061	Coil 110-7H2-440C	R5	RK0028	Chip R, MCR10EZHU471E
CU8016	Chip C, C2012B1H102K	L5	QC0018	Coil K3002 12NH	R6	RK0022	Chip R, MCR10EZHU221E (DR-510E only)
CU8016	Chip C, C2012B1H102K	L6	QC0050	Coil 5x5 1/4 T	R8	RK0037	Chip R, MCR10EZHU152E
CU8016	Chip C, C2012B1H102K	L7	QA0042	Coil 30R8MIF	R9	RK0011	Chip R, MCR10EZHU470E
CU0011	Chip C, C2012CH1H100D	L8	QA0043	Coil 30R8MIF	R10	RK0052	Chip R, MCR10EZHU103E
CU8016	Chip C, C2012B1H102K	L9	QA0043	Coil 30R8MIF	R11	RK0069	Chip R, MCR10EZHU104E
CU8038	Chip C, CM316Y5V105Z25VAT	L10	QC0039	Coil NL322522T-1ROM	R12	RK0028	Chip R, MCR10EZHU471E
CU8038	Chip C, CM316Y5V105Z25VAT	L11	QC0045	Coil 4x1R2xOR6	R13	RK0022	Chip R, MCR10EZHU221E (DR-510E only)
CU8034	Chip C, C2012B1E333K	L12	QA0041	Coil 455K IF	R14	RK0011	Chip R, MCR10EZHU470E
CE0064	Chemical C, 10 V 47 μF MS9	L13	QC0048	Coil NL322522T 100K	R15	RK0107	Chip R, MCR10EZHU000E
CE0064	Chemical C, 10 V 47 μF MS9	L14	QC0020	Coil K3004 25NH	R16	RK0107	Chip R, MCR10EZHU000E
CE0064	Chemical C, 10 V 47 μF MS9	L15	QC0020	Coil K3004 25NH	R17	RK0052	Chip R, MCR10EZHU103E
CE0151	Chemical C, 10 V 470 μF SSP	L16	QC0020	Coil K3004 25NH	R18	RK0035	Chip R, MCR10EZHU102E
CU8003	Chemical C, JF1E104Z	L17	QC0020	Coil K3004 25NH	R19	RK0052	Chip R, MCR10EZHU103E
CE0051	Chemical C, 16 V 1000 μF MS16	IC1	XA0082	IC, MC7808CT	C1	CU8016	Chip C, C2012B1H102K
CE8028	Chemical C, 103K	IC2	XA0078	IC, M54959	C2	CU8028	Chip C, C2012B1H103K
CE0051	Chemical C, 16 V 1000 μF MS16	IC4	XA0079	IC, μPC1241H	C3	CU0003	Chip C, C2012CH1H020C
CE8028	Chemical C, 103K	FL1	XF0005	XF IL30. 8M 15A HC49/T	C4	CU0009	Chip C, C2012CH1H080D
CE0006	Chemical C, C2012CH1H050C	FL2	XC0001	Ceramic F, CFW 455F	C5	CU0011	Chip C, C2012CH1H100D
CE0064	Chemical C, 10 V 47 μF MS9	D1	XD0103	Diode, ISS226TE85L	C6	CU0061	Chip C, C2012CH1H120J
CU8016	Chip C, C2012B1H102K	D3	XD0040	Diode, DAN202KT96	C7	CU0029	Chip C, C2012CH1H560K (DR-510T only)
CU8016	Chip C, C2012B1H102K	D4	XD0040	Diode	C7	CU0008	Chip C, C2012CH1H070D (DR-510E only)
CE0030	Chemical C, 16 V 10 μF MS7	D5	XD0104	Diode, 02CZ6.2YTE85L	C8	CU8016	Chip C, C2012B1H102K
CU8016	Chip C, C2012B1H102K	D6	XD0041	Diode, DAP202KT96	C9	CU0003	Chip C, C2012CH1H020C
CE0199	Chemical C, 16 V 100 μF MS7	D7	XD0070	Diode, ISS265	C10	CU0009	Chip C, C2012CH1H080D
CU8016	Chip C, C2012B1H102K	D8	XD0070	Diode, ISS265	C11	CU0011	Chip C, C2012CH1H100D
CU8016	Chip C, C2012B1H102K	D9	XD0041	Diode, DAP202KT96	C12	CU8016	Chip C, C2012B1H102K
CU8016	Chip C, C2012B1H102K	D10	XD0058	Diode, ISS181	C13	CU8016	Chip C, C2012B1H102K
CU8016	Chip C, C2012B1H102K	D11	XD0040	Diode, DAN202KT96	C14	CU8016	Chip C, C2012B1H102K
CU8016	Chip C, C2012B1H102K	D12	XD0040	Diode, DAN202KT96	C15	CU8016	Chip C, C2012B1H102K
CU8016	Chip C, C2012B1H102K	D13	XD0080	Diode, RB400D796	C16	CU8016	Chip C, C2012B1H102K
CE0122	Chemical C, 16 V 22 μF SM7	D14	XD0080	Diode, RB400DT96	C17	CU0001	Chip C, C2012CH1H0R5C
CS0064	Chip Tantal C, TMC1A155TR	D15	XD0040	Diode, DAN202KT96	C18	CU8016	Chip C, C2012B1H102K
CU8025	Chip C, C2012B1H562K	D17	XD0040	Diode, DAN202KT96	C19	CU0003	Chip C, C2012CH1H020C
CU8025	Chip C, C2012B1H562K	D18	XD0078	Diode, DAN235KT96	C20	CU8016	Chip C, C2012B1H102K
CE0125	Chemical C, 25 V 4.7 μF MS7	D20	XL0011	LED, TLG211	Q1	XT0074	Transistor 2SC2759T1
CE8028	Chemical C, 103K	Q1	XE0013	FET, 3SK184STX	Q2	XE0010	Transistor 2SK508K52T1
CE8028	Chemical C, 103K	Q2	XE0002	FET, 2SK125	Q3	XT0037	Transistor 2SC2412KT96R
CE8028	Chemical C, 103K	Q3	XE0014	FET, 3SK184RTX	Q4	XE0010	Transistor 2SK508K52T1
CE8028	Chemical C, 103K	Q4	XT0059	Transistor, 2SC3082	Q5	XU0012	Transistor DTC114EKT96
CE8028	Chemical C, 103K	Q5	XT0077	Transistor, 2SC3326ATE85L	D1	XD0100	Varicap 1SV164T1
CE8003	Chemical C, JF1E104Z	Q6	XT0061	Transistor, 2SB1132T100Q	D2	XD0100	Varicap 1SV164T1
CU8016	Chip C, C2012B1H102K	Q7	XT0061	Transistor, 2SB1132T100Q	D3	XD0100	Varicap 1SV164T1
CU8016	Chip C, C2012B1H102K	Q8	XU0018	Digital Transistor DTC124EKT96	D4	XD0100	Varicap 1SV164T1
CU8016	Chip C, C2012B1H102K	Q9	XU0018	Digital Transistor DTC124EKT96	D5	XD0078	Diode DAN235KT96
CU8016	Chip C, C2012B1H102K	Q10	XT0037	Transistor, 2SC2412KT96R	TC1	CT0022	Trimmer C, ECRJA020E12W
CU8016	Chip C, C2012B1H102K	Q11	XT0037	Transistor, 2SC2412KT96R	TC2	CT0021	Trimmer C, ECRJA010A12W
CU8016	Chip C, C2012B1H102K	Q12	XT0037	Transistor, 2SC2412KT96R	L1	QK0076	Coil QK0076 (DR-510T only)
CU0035	Chip C, C2012CH1H101K	Q13	XT0037	Transistor, 2SC2412KT96R	L1	QK0039	Coil QK0039 (DR-510E only)
CU0035	Chip C, C2012CH1H101K	Q14	XT0037	Transistor, 2SC2412KT96R	L2	QK0039	Coil QK0039
CU0035	Chip C, C2012CH1H101K	Q15	XT0037	Transistor, 2SC2412KT96R	L3	QC0036	Coil NL322522T-R56M
CU8016	Chip C, C2012B1H102K	Q16	XT0038	Transistor, 2SA1037KT96R	L4	QC0036	Coil NL322522T-R56M
CU8016	Chip C, C2012B1H102K	Q17	XT0030	Transistor, 2SC3356T1	L5	QC0036	Coil NL322522T-R56M
CU8016	Chip C, C2012B1H102K	Q18	XT0030	Transistor, 2SC3356T1	L6	QC0036	Coil NL322522T-R56M
CU8016	Chip C, C2012B1H102K	Q19	XT0037	Transistor, 2SC2412KT96R	L7	QC0036	Coil NL322522T-R56M
CU8016	Chip C, C2012B1H102K	Q20	XT0078	Transistor, 2SC3369	L8	QC0036	Coil NL322522T-R56M
CK0003	Ceramic C, 50 V 102Z	Q21	XT0064	Transistor, 2SD1761E	L9	QC0022	Coil K300639NH
CE0149	Chemical C, 10 V 220 μF 8SP	Q22	XT0037	Transistor, 2SC2412KT96R	L10	QC0010	Coil MLF3216E100M (DR-510T only)
RH0043	VR, VM6CK-PV-1S501B	Q23	XT0037	Transistor, 2SC2412KT96R	L10	QC0052	Coil LER015TR56M (DR-510E only)
RH0044	VR, VM6CK-PV-1S103B	Q24	XT0037	Transistor, 2SC2412KT96R	<b>RX-SW Unit</b>		
RH0044	VR, VM6CK-PV-1S103B	Q25	XU0012	Digital Transistor DTC114EKT96			
RH0046	VR, VM6CK-PV-1S503B	X1	XQ0037	X'tal HC-49/u 12.8 MHz	R1	RK0062	Chip R, MCR10EZHU473E
RH0044	VR, VM6CK-PV-1S103B	X2	XQ0034	X'tal HC-49/u 30.4 MHz	R2	RK0107	Chip R, MCR10EZHU000E
RH0044	VR, VM6CK-PV-1S103B	TH1	Thermistor	TD 5A150D	R3	RK0107	Chip R, MCR10EZHU000E
RH0045	VR, VM6CK-PV-1S303B	<b>UHF VCO Unit</b>			R4	RK0107	Chip R, MCR10EZHU000E
RH0021	VR, H0651A 10KB	R1	RK0019	Chip R, MCR10EZHU121E			
CT0015	Trimmer C, CV05A0601						
CT0015	Trimmer C, CV05A0601						
CT0015	Trimmer C, CV05A0601						
CT0024	Trimmer C, ECRLA010A12						
CT0024	Trimmer C, ECRLA010A12						
CT0015	Trimmer C, CV05A0601						

Ref. No.	Part Code	Part Name and Number
R5	RK0107	Chip R, MCR10EZJH000E
D1	XD0040	Diode DAN202KT96
D2	XD0040	Diode DAN202KT96
D3	XD0041	Diode DAP202KT96
D4	XD0105	Diode 02CZ3.9XTE85L
D5	XD0105	Diode 02CZ3.9XTE85L
C1	CS0049	Chip Tantal, TMC1C105TR
C2	CS0049	Chip Tantal, TMC1C105TR
C3	CS0049	Chip Tantal, TMC1C105TR
Q1	XU0019	Transistor DTA114YKT96
Q2	XU0021	Transistor FMC3T98
Q3	XU0019	Transistor DTA114YKT96
Q4	XU0019	Transistor DTA114YKT96
<b>APC Unit</b>		
R1	RK0039	Chip R, MCR10EZJH222E
R2	RK0035	Chip R, MCR10EZJH102E
R3	RK0037	Chip R, MCR10EZJH152E
R4	RK0052	Chip R, MCR10EZJH103E
R5	RK0052	Chip R, MCR10EZJH103E
R6	RK0036	Chip R, MCR10EZJH122E
C1	CU8016	Chip C, C2012B1H102K
C2	CS0064	Chip Tantal, TMC1A155TR
C3	CU8024	Chip C, C2012B1H472K
C4	CU8016	Chip C, C2012B1H102K
C5	CU8024	Chip C, C2012B1H472K
C6	CU8016	Chip C, C2012B1H102K
Q1	XU0020	Transistor FMW1T98
Q2	XU0020	Transistor FMW1T98
Q3	XU0038	Transistor 2SA1037KT96R
<b>Lock SW Unit</b>		
R1	RK0045	Chip R, MCR10EZJH472E
R2	RK0045	Chip R, MCR10EZJH472E
R3	RK0045	Chip R, MCR10EZJH472E
R4	RK0045	Chip R, MCR10EZJH472E
R5	RK0045	Chip R, MCR10EZJH472E
R6	RK0052	Chip R, MCR10EZJH103E
C1	CU8016	Chip C, C2012B1H102K
C2	CU8016	Chip C, C2012B1H102K
D1	XD0040	Diode DAN202KT96
Q1	XT0038	Transistor 2SA1037KT96R
Q2	XT0038	Transistor 2SA1037KT96R
Q3	XT0037	Transistor 2SC2412KT96R
<b>IF Unit</b>		
R1	RK0069	Chip R, MCR10EZJH104E
R2	RK0069	Chip R, MCR10EZJH104E
R4	RK0042	Chip R, MCR10EZJH332E
R5	RK0038	Chip R, MCR10EZJH182E
C2	CU8016	Chip C, C2012B1H102K
C3	CU0066	Chip C, C2012CH1H330J
C4	CU8024	Chip C, C2012B1H472K
C5	CU2059	Chip C, C2012SL1H561J
C6	CU8024	Chip C, C2012B1H472K
C7	CU8028	Chip C, C2012B1H103K
C8	CU8003	Chip C, C2012JF1E104Z
C9	CU8003	Chip C, C2012JF1E104Z
C10	CU8003	Chip C, C2012JF1E104Z
IC1	XA0070	IC, MC3361D T
L1	QC0049	Coil, NL322522T-221K
L2	QC0050	Coil, NL453232T-102K

Ref. No.	Part Code	Part Name and Number
<b>SQL Unit</b>		
R1	RK0069	Chip R, MCR10EZJH104E
R2	RK0040	Chip R, MCR10EZJH272E
R3	RK0039	Chip R, MCR10EZJH222E
R4	RK0056	Chip R, MCR10EZJH223E
R5	RK0042	Chip R, MCR10EZJH332E
R6	RK0048	Chip R, MCR10EZJH682E
R7	RK0052	Chip R, MCR10EZJH103E
R8	RK0069	Chip R, MCR10EZJH104E
R9	RK0045	Chip R, MCR10EZJH472E
R10	RK0079	Chip R, MCR10EZJH474E
R11	RK0057	Chip R, MCR10EZJH273E
R12	RK0056	Chip R, MCR10EZJH223E
R13	RK0039	Chip R, MCR10EZJH222E
R14	RK0061	Chip R, MCR10EZJH393E
R15	RK0057	Chip R, MCR10EZJH273E
R17	RK0039	Chip R, MCR10EZJH222E
C1	CU8016	Chip C, C2012B1H102K
C2	CU0066	Chip C, C2012CH1H330J
C4	CU9015	Chip C, 32161E 0.1 μFZ
C5	CU8038	Chip C, CM316Y5V105Z25VAT
C6	CS0065	Chip Tantal, TMC1D684TR
C7	CU8035	Chip C, C2012B1E393K
C8	CU8035	Chip C, C2012B1E393K
C9	CU8030	Chip C, C2012B1H153K
C10	CU8034	Chip C, C2012B1E333K
D1	XD0103	Diode ISS226TE85L
D2	XD0041	Diode DAP202KT96
Q1	XT0037	Transistor, 2SC2412KT96R
Q2	XT0037	Transistor, 2SC2412KT96R
Q3	XT0076	Transistor, 2SC3295BTE85L
Q4	XT0076	Transistor, 2SC3295BTE85L
Q5	XT0037	Transistor, 2SC2412KT96R
Q6	XT0037	Transistor, 2SC2412KT96R
<b>MIC Unit</b>		
R1	RK0053	Chip R, MCR10EZJH123E
R2	RK0062	Chip R, MCR10EZJH473E
R3	RK0064	Chip R, MCR10EZJH563E
R4	RK0018	Chip R, MCR10EZJH101E
R5	RK0071	Chip R, MCR10EZJH154E
R6	RK0069	Chip R, MCR10EZJH104E
R7	RK0018	Chip R, MCR10EZJH101E
R8	RK0062	Chip R, MCR10EZJH473E
R9	RK0062	Chip R, MCR10EZJH473E
R10	RK0030	Chip R, MCR10EZJH561E
R11	RK0074	Chip R, MCR10EZJH274E
R12	RK0064	Chip R, MCR10EZJH563E
R13	RK0073	Chip R, MCR10EZJH224E
R14	RK0067	Chip R, MCR10EZJH823E
R15	RK0067	Chip R, MCR10EZJH823E
R16	RK0067	Chip R, MCR10EZJH823E
R17	RK0052	Chip R, MCR10EZJH103E
R18	RK0107	Chip R, MCR10EZJH000E
C1	CU8032	Chip C, C2012B1E223K
C2	CU8038	Chip C, CM316Y5V105Z25VAT
C3	CU8034	Chip C, C2012B1E333K
C4	CU8032	Chip C, C2012B1E223K
C6	CU8038	Chip C, CM316Y5V105Z25VAT
C7	CU0071	Chip C, C2012CH1H101J
C8	CU8021	Chip C, C2012B1H272K
C9	CU8038	Chip C, CM316Y5V105Z25VAT
C10	CU0071	Chip C, C2012CH1H101J
C11	CU8015	Chip C, C2012B1H821K
IC1	XA0068	IC, M5218FP-T01-1
IC2	XA0068	IC, M5218FP-T01-1
<b>APC Unit</b>		
R1	RK0039	Chip R, MCR10EZJH222E

Ref. No.	Part Code	Part Name and Number
R2	RK0035	Chip R, MCR10EZJH102E
R3	RK0037	Chip R, MCR10EZJH152E
R4	RK0052	Chip R, MCR10EZJH103E
R5	RK0052	Chip R, MCR10EZJH103E
R6	RK0036	Chip R, MCR10EZJH122E
Q1	XU0020	Transistor, FMW1 T98
Q2	XU0020	Transistor, FMW1 T98
Q3	XT0038	Transistor, 2SA1037KT96R
C1	CU8016	Chip C, C2012B1H102K
C2	CS0064	Chip Tantal, TMC1A155TR
C3	CU8024	Chip C, C2012B1H472K
C4	CU8016	Chip C, C2012B1H102K
C5	CU8024	Chip C, C2012B1H472K
C6	CU8016	Chip C, C2012B1H102K
<b>VHF Drive Unit</b>		
R7	RK0018	Chip R, MCR10EZJH101E
R8	RK0035	Chip R, MCR10EZJH102E
R10	RK0014	Chip R, MCR10EZJH680E
R11	RK0038	Chip R, MCR10EZJH182E
R12	RK0028	Chip R, MCR10EZJH471E
R13	RK0010	Chip R, MCR10EZJH390E
R14	RK0005	Chip R, MCR10EZJH220E
R16	RK0025	Chip R, MCR10EZJH331E
R17	RK0045	Chip R, MCR10EZJH472E
R19	RK0056	Chip R, MCR10EZJH223E
Q4	XT0059	Transistor, 2SC3082KT96Q
Q5	XT0071	Transistor, 2SC3837KT96N
L1	QC0024	Chip L, K300860NH
C3	CU8028	Chip C, C2012B1H103K
C4	CU8028	Chip C, C2012B1H103K
C5	CU8016	Chip C, C2012B1H102K
C6	CU0066	Chip C, C2012CH1H330J
C7	CU8028	Chip C, C2012B1H103K
C8	CU8028	Chip C, C2012B1H103K
C9	CU8028	Chip C, C2012B1H103K
C10	CU8016	Chip C, C2012B1H102K
C11	CS0049	Chip Tantal, TMC1C105TR
C12	CU0003	Chip C, C2012CH1H020C
<b>VHF VCO Unit</b>		
R1	RK0018	Chip R, MCR10EZJH101E
R2	RK0056	Chip R, MCR10EZJH223E
R3	RK0052	Chip R, MCR10EZJH103E
R4	RK0018	Chip R, MCR10EZJH101E
R5	RK0011	Chip R, MCR10EZJH470E
R6	RK0027	Chip R, MCR10EZJH391E
R7	RK0069	Chip R, MCR10EZJH104E
R8	RK0052	Chip R, MCR10EZJH103E
R9	RK0037	Chip R, MCR10EZJH152E
R10	RK0067	Chip R, MCR10EZJH823E
R11	RK0073	Chip R, MCR10EZJH224E
R12	RK0011	Chip R, MCR10EZJH470E
R13	RK0021	Chip R, MCR10EZJH181E
R14	RK0048	Chip R, MCR10EZJH682E
R15	RK0052	Chip R, MCR10EZJH103E
R16	RK0052	Chip R, MCR10EZJH103E
R17	RK0035	Chip R, MCR10EZJH102E
D1	XD0040	Diode DAN202KT96
D2	XD0100	Varicap ISV164T1
D3	XD0101	Varicap ISV166T1
D4	XD0101	Varicap ISV166T1
D5	XD0094	Diode ISS153T1
Q1	XT0075	Transistor, 2SC2757T1
Q2	XE0010	FET 2SK508K52T1
Q3	XT0037	Transistor, 2SC2412KT96R
Q4	XE0011	FET 2SK508K51T1

Part Code	Part Name and Number	Ref. No.	Part Code	Part Name and Number	Ref. No.	Part Code	Part Name and Number
QC0045	Chip L, NL322522T-3R3M	X2	XQ0033	X'tal HC-49/u 10.245 MHz	R82	RK0052	Chip R, MCR10EZHZ103E
QK0042	Coil 3x5R0x0R6				R89	RK0018	Chip R, MCR10EZHZ101E
QC0045	Chip L, NL322522T-3R3M	TH1	XS0004	Thermistor TD5A150D	R90	RK0038	Chip R, MCR10EZHZ182E
QC0045	Chip L, NL322522T-3R3M				R91	RK0020	Chip R, MCR10EZHZ151E
QK0041	Coil 3x4R0x0R8	IC1	XA0082	IC, MC7808CT	R94	RK0039	Chip R, MCR10EZHZ222E
QC0039	Chip L, NL322522T-1R0M	IC2	XA0078	IC, M54959P	R95	RK2008	Chip R, MCR50JZHJ220E
					R96	RK0069	Chip R, MCR50JZHJ104E
CT0021	Trimmer C, ECRJA010A12W	R1	RK0047	Chip R, MCR10EZHZ562E	R98	RK0069	Chip R, MCR50JZHJ104E
CT0021	Trimmer C, ECRJA010A12W	R2	RK0052	Chip R, MCR10EZHZ103E	R100	RK0045	Chip R, MCR50JZHJ472E
		R3	RK0056	Chip R, MCR10EZHZ223E	R103	RK0055	Chip R, MCR50JZHJ183E
CU8016	Chip C, C2012B1H102K	R4	RK0018	Chip R, MCR10EZHZ101E	R104	RK0052	Chip R, MCR50JZHJ103E
CU8016	Chip C, C2012B1H102K	R5	RK0011	Chip R, MCR10EZHZ470E	R109	RK0035	Chip R, MCR50JZHJ102E
CU0004	Chip C, C2012CH1H030C	R6	RK0025	Chip R, MCR10EZHZ331E	R110	RK0069	Chip R, MCR50JZHJ104E
CU8028	Chip C, C2012B1H103K	R7	RK0011	Chip R, MCR10EZHZ470E	R111	RK0069	Chip R, MCR50JZHJ104E
CU0004	Chip C, C2012CH1H030C	R8	RK0052	Chip R, MCR10EZHZ103E	R112	RK0069	Chip R, MCR50JZHJ104E
CU0011	Chip C, C2012CH1H100D	R9	RK0062	Chip R, MCR10EZHZ473E	R113	RK0062	Chip R, MCR50JZHJ473E
CU0009	Chip C, C2012CH1H080D	R10	RK0011	Chip R, MCR10EZHZ470E	R114	RK0035	Chip R, MCR50JZHJ102E
CU0064	Chip C, C2012CH1H220J	R11	RK0062	Chip R, MCR10EZHZ473E	R115	RK0035	Chip R, MCR50JZHJ102E
CU0001	Chip C, C2012CH1H0R5C	R12	RK0035	Chip R, MCR10EZHZ102E	R116	RK0035	Chip R, MCR50JZHJ102E
CU0065	Chip C, C2012CH1H270J	R13	RK0001	Chip R, MCR10EZHZ470E	R118	RK0107	Chip R, MCR50JZHJ000E
CU8016	Chip C, C2012B1H102K	R14	RK0074	Chip R, MCR10EZHZ274E	R121	RK0107	Chip R, MCR50JZHJ000E
CU0004	Chip C, C2012CH1H030C	R15	RK0018	Chip R, MCR10EZHZ101E	R122	RK0107	Chip R, MCR10EZHZ000E
CU8028	Chip C, C2012B1H103K	R16	RK0038	Chip R, MCR10EZHZ182E	R124	RK0107	Chip R, MCR10EZHZ000E
CU0004	Chip C, C2012CH1H030C	R17	RK0062	Chip R, MCR10EZHZ473E	R127	RK0056	Chip R, MCR10EZHZ223E
CU0061	Chip C, C2012CH1H120J	R18	RK0052	Chip R, MCR10EZHZ103E	R128	RK0057	Chip R, MCR10EZHZ273E
CU0066	Chip C, C2012CH1H330J	R19	RK0018	Chip R, MCR10EZHZ101E	R129	RK0008	Chip R, MCR10EZHZ330E
CU0060	Chip C, C2012CH1H470J	R20	RK0028	Chip R, MCR10EZHZ471E	R130	RK0052	Chip R, MCR10EZHZ103E
CU0011	Chip C, C2012CH1H100D	R21	RK0018	Chip R, MCR10EZHZ101E	R131	RK0052	Chip R, MCR10EZHZ101E
CU8016	Chip C, C2012B1H102K	R23	RK0038	Chip R, MCR10EZHZ182E	R132	RK0056	Chip R, MCR10EZHZ223E
CU0060	Chip C, C2012CH1H470J	R25	RK0059	Chip R, MCR10EZHZ333E	R133	RK0052	Chip R, MCR10EZHZ103E
CU8016	Chip C, C2012B1H102K	R31	RK0035	Chip R, MCR10EZHZ102E	R140	RK0107	Chip R, MCR10EZHZ000E
CU8016	Chip C, C2012B1H102K	R33	RK0069	Chip R, MCR10EZHZ104E	R141	RK0035	Chip R, MCR10EZHZ102E
CE0198	Chemical C, 10MS5100	R34	RK0039	Chip R, MCR10EZHZ222E	R142	RD0116	R, R20R02J1R0
		R35	RK0107	Chip R, MCR10EZHZ000E	R143	RK0039	Chip R, MCR10EZHZ222E
		R36	RK0038	Chip R, MCR10EZHZ182E	R144	RK0107	Chip R, MCR10EZHZ000E
		R37	RK0052	Chip R, MCR10EZHZ103E			
		R38	RK0038	Chip R, MCR10EZHZ182E	L1	QA0038	Coil, 114M RF
		R39	RK0035	Chip R, MCR10EZHZ102E	L2	QA0038	Coil, 114M RF
		R40	RK0052	Chip R, MCR10EZHZ103E	L3	QA0053	Coil, 144M
		R41	RK0038	Chip R, MCR10EZHZ182E	L4	QA0053	Coil, 144M
		R42	RK0035	Chip R, MCR10EZHZ102E	L5	QA0054	Coil, 144M
		R43	RK0001	Chip R, MCR10EZHZ100E	L6	QA0037	Coil, 144M TC
		R44	RK0045	Chip R, MCR10EZHZ472E	L7	QA0039	Coil, 10R7M IF
		R45	RK0062	Chip R, MCR10EZHZ473E	L8	QA0039	Coil, 10R7M IF
		R46	RK0062	Chip R, MCR10EZHZ473E	L10	QA0041	Coil, 455K IF
		R47	RK0062	Chip R, MCR10EZHZ473E	L11	QL0007	Choke Coil, 1R6MH R6A
		R48	RK0062	Chip R, MCR10EZHZ473E	L13	QC0045	Chip L, NL322522T-3R3M
		R49	RK0062	Chip R, MCR10EZHZ473E	L14	QC0034	Chip L, NL322522T-R39M
		R50	RK0048	Chip R, MCR10EZHZ682E	L15	QK0032	Coil, 3x4T
		R51	RK0076	Chip R, MCR10EZHZ334E	L16	QK0042	Coil, 3x5R0x0R6
		R52	RK0044	Chip R, MCR10EZHZ392E			
		R53	RK0076	Chip R, MCR10EZHZ334E	C1	CU0066	Chip C, C2012CH1H330J
		R54	RK0044	Chip R, MCR10EZHZ392E	C2	CU0061	Chip C, C2012CH1H120J
		R55	RK0056	Chip R, MCR10EZHZ223E	C3	CU0009	Chip C, C2012CH1H080C
		R58	RK0018	Chip R, MCR10EZHZ101E	C4	CU0010	Chip C, C2012CH1H080D
		R59	RK0056	Chip R, MCR10EZHZ223E	C5	CU8016	Chip C, C2012B1H102K
		R60	RK0052	Chip R, MCR10EZHZ103E	C6	CU8016	Chip C, C2012B1H102K
		R62	RK0052	Chip R, MCR10EZHZ103E	C7	CU8028	Chip C, C2012B1H103K
		R63	RK0062	Chip R, MCR10EZHZ473E	C8	CU8016	Chip C, C2012B1H102K
		R64	RK0040	Chip R, MCR10EZHZ272E	C9	CU8016	Chip C, C2012B1H102K
		R65	RK0040	Chip R, MCR10EZHZ272E	C10	CU8028	Chip C, C2012B1H103K
		R66	RK0050	Chip R, MCR10EZHZ822E	C11	CU0005	Chip C, C2012CH1H040C
		R67	RK0038	Chip R, MCR10EZHZ182E	C12	CU0062	Chip C, C2012CH1H150J
		R68	RK0052	Chip R, MCR10EZHZ103E	C13	CU8016	Chip C, C2012B1H102K
		R69	RK0052	Chip R, MCR10EZHZ103E	C14	CU8028	Chip C, C2012B1H103K
		R70	RK0045	Chip R, MCR10EZHZ472E	C15	CU0006	Chip C, C2012CH1H050C
		R71	RK0056	Chip R, MCR10EZHZ223E	C16	CU8016	Chip C, C2012B1H102K
		R72	RK0052	Chip R, MCR10EZHZ103E	C17	CU8028	Chip C, C2012B1H103K
		R73	RK0056	Chip R, MCR10EZHZ223E	C18	CU8028	Chip C, C2012B1H103K
		R74	RK0018	Chip R, MCR10EZHZ101E	C19	CU8028	Chip C, C2012B1H103K
		R75	RK0035	Chip R, MCR10EZHZ102E	C20	CU8016	Chip C, C2012B1H102K
		R76	RK0018	Chip R, MCR10EZHZ101E	C21	CE0064	Chemical C, 10 V 47 uF MS9
		R77	RK0035	Chip R, MCR10EZHZ102E	C22	CU2073	Chip C, C2012S1L15J
		R78	RK0056	Chip R, MCR10EZHZ223E	C23	CU8028	Chip C, C2012B1H103K
		R79	RK0052	Chip R, MCR10EZHZ103E	C25	CU0066	Chip C, C2012CH1H330J
		R80	RK0018	Chip R, MCR10EZHZ101E	C27	CU8016	Chip C, C2012B1H102K
		R81	RK0052	Chip R, MCR10EZHZ103E	C32	CU8003	Chip C, C2012JF1E104Z
<b>VHF Main Unit</b>							
XE0013	FET, 3SK184STX						
XE0012	FET, 3SK131V11(V12)T1						
XT0059	Transistor, 2SC3082KT96Q						
XT0061	Transistor, 2SB1132T100Q						
XT0061	Transistor, 2SB1132T100Q						
XU0018	Transistor, DTC124EKT96						
XU0018	Transistor, DTC124EKT96						
XT0037	Transistor, 2SC2412KT96R						
XT0081	Transistor, 2SC2714Y						
XT0037	Transistor, 2SC2412KT96R						
XT0037	Transistor, 2SC2412KT96R						
XT0038	Transistor, 2SA1037KT96R						
XT0030	Transistor, 2SC3356T1						
XT0030	Transistor, 2SC3356T1						
XT0037	Transistor, 2SC2412KT96R						
XT0078	Transistor, 2SC3369						
XT0064	Transistor, 2SD1761E						
XT0037	Transistor, 2SC2412KT96R						
XT0037	Transistor, 2SC2412KT96R						
XD0103	Diode ISS226TE85L						
XD0040	Diode DAN202KT96						
XD0040	Diode DAN202KT96						
XD0104	Diode 02CZ6.2YTE85L						
XD0041	Diode DAP202KT96						
XD0070	Diode ISS265						
XD0070	Diode ISS265						
XD0041	Diode DAP202KT96						
XD0058	Diode ISS181TE85L						
XD0100	Varicap ISV164T1						
XD0100	Varicap ISV164T1						
XD0100	Varicap ISV164T1						
XD0040	Diode DAN202KT96						
XD0040	Diode DAN202KT96						
XD0080	Diode RB400DT96						
XD0080	Diode RB400DT96						
XF0004	XF 1L10.7M 15 A 49/T						
XC0001	Ceramic Filter CFW455F						
XQ0037	X'tal HC-49/u 12.8 MHz						

Ref. No.	Part Code	Part Name and Number	Ref. No.	Part Code	Part Name and Number	Ref. No.	Part Code	Part Name and Number
C33	CU8003	Chip C, C2012JF1E104Z	TC4	CT0025	Trimmer C, ECRLA020E12	R20	RK0107	Chip R, MCR10EZHZJ000E
C34	CU8028	Chip C, C2012B1H103K	VR1	RH0043	VR VM6CK-PV-1S501B	C1	CS0049	Chip Tantal, TMC1C105TR
C35	CU8016	Chip C, C2012B1H102K	VR2	RH0044	VR VM6CK-PV-1S103B	C2	CS0049	Chip Tantal, TMC1C105TR
C36	CU8016	Chip C, C2012B1H102K	VR3	RH0044	VR VM6CK-PV-1S103B	C3	CU8003	Chip C, C2012JF1E104Z
C37	CE0064	Chemical C, 10 V 47 $\mu$ F MS9	VR4	RH0046	VR VM6CK-PV-1S503B	C4	CU8003	Chip C, C2012JF1E104Z
C38	CU8034	Chip C, C2012B1E333K	VR5	RH0046	VR VM6CK-PV-1S503B	C5	CU8028	Chip C, C2012B1H103K
C39	CE0064	Chemical C, 10 V 47 $\mu$ F MS9	VR6	RH0044	VR VM6CK-PV-1S103B	C6	CU0051	Chip Tantal, TMC1C106TR
C40	CU8038	Chip C, CM316Y5V105Z25VAT	VR7	RH0045	VR VM6CK-PV-1S303B	C8	CU8003	Chip C, C2012JF1E104Z
C41	CU8028	Chip C, C2012B1H103K	1750 Hz Tone Burst Unit			C11	CS0051	Chip Tantal, TMC1C106TR
C42	CE0064	Chemical C, 10 V 47 $\mu$ F MS9				C2	CU8003	Chip C, C2012JF1E
C43	CU8028	Chip C, C2012B1H103K	C3	CU0051	Chip C, C2012CH1H471K	C13	CU8038	Chip C, C3216B1H105K
C44	CE0030	Chemical C, 16 V 10 $\mu$ F MS7	C4	CU8005	Chip C, C2012B1H222K	C14	CS0049	Chip Tantal, TMC1C105TR
C45	CS0049	Chip Tantal, TMC1C105TR	C5	CU8016	Chip C, C2012B1H102K	C15	CS0050	Chip Tantal, TMC1A475TR
C46	CE0064	Chemical C, 10 V 47 $\mu$ F MS9	C6	CU8028	Chip C, C2012B1H103K	C16	CC0105	Ceramic C, 50 V 4 pF CH
C47	CU8016	Chip C, C2012B1H102K	C7	CS0049	Chip Tantal, TMC1C105TR	C17	CU8003	Chip C, C2012JF1E104Z
C48	CU8028	Chip C, C2012B1H103K	C8	CU8016	Chip C, C2012B1H102K	Q1	XU0002	Transistor, DTC114YKT96
C49	CU8028	Chip C, C2012B1H103K	C9	CS0050	Chip Tantal, TMC1A475TR	Q2	XU0002	Transistor, DTC114YKT96
C50	CU8028	Chip C, C2012B1H103K	C10	CU0011	Chip C, C2012CH1H100D	Q3	XT0037	Transistor, 2SC2412KT96R
C51	CU8003	Chip C, C2012JF1E104Z	C11	CU0011	Chip C, C2012CH1H100D	Q4	XU0002	Transistor, DTC114YKT96
C53	CU8028	Chip C, C2012B1H103K	C12	CU8016	Chip C, C2012B1H102K	Q5	XU0002	Transistor, DTC114YKT96
C54	CU0064	Chip C, C2012CH1H220J	R1	RK0079	Chip R, MCR10EZHZJ474E	Q6	XT0037	Transistor, 2SC2412KT96R
C55	CU0043	Chip C, C2012CH1H221K	R2	RK0062	Chip R, MCR10EZHZJ473E	Q7	XU0002	Transistor, DTC114YKT96
C56	CU0071	Chip C, C2012CH1H101J	R3	RK0069	Chip R, MCR10EZHZJ104E	IC1	XA0020	IC, MN6520
C57	CU0071	Chip C, C2012CH1H101J	R4	RK0056	Chip R, MCR10EZHZJ223E	IC2	XA0019	IC, MPD4094BG
C59	CQ0007	Film C, 50F2M473K	R5	RK0052	Chip R, MCR10EZHZJ103E	FAR1	XB0002	FAR, C4CA04194000K01
C60	CU0071	Chip C, C2012CH1H101J	R7	RK0107	Chip R, MCR10EZHZJ000E	VR1	RH0051	VR, CVR-42A-472AW1D
C61	CU2051	Chip C, C2012SL471K	R8	RK0107	Chip R, MCR10EZHZJ000E	Crystal Converter Unit		
C62	CU8019	Chip C, C2012B1H182K	R9	RK0086	Chip R, MCR10EZHZJ105E			
C63	CU8028	Chip C, C2012B1H103K	R10	RK0107	Chip R, MCR10EZHZJ000E	R2	RK0048	Chip R, MCR10EZHZJ682E
C65	CU8016	Chip C, C2012B1H102K	R11	RK0062	Chip R, MCR10EZHZJ473E	R3	RK0054	Chip R, MCR10EZHZJ153E
C67	CU8028	Chip C, C2012B1H103K	R12	RK0018	Chip R, MCR10EZHZJ101E	R4	RK0045	Chip R, MCR10EZHZJ472E
C68	CQ0008	Film C, 50F2M683K	R13	RK0035	Chip R, MCR10EZHZJ102E	R5	RK0028	Chip R, MCR10EZHZJ471E
C69	CS0049	Chip Tantal, TMC1C105TR	R14	RK0035	Chip R, MCR10EZHZJ102E	R6	RK0052	Chip R, MCR10EZHZJ103E
C70	GE0199	Chemical C, 16 V 100 $\mu$ F MS7	R15	RK0062	Chip R, MCR10EZHZJ473E	R7	RK0040	Chip R, MCR10EZHZJ272E
C72	CU0066	Chip C, C2012CH1H330J	R16	RK0107	Chip R, MCR10EZHZJ000E	R8	RK0062	Chip R, MCR10EZHZJ473E
C73	CU8016	Chip C, C2012B1H102K	R17	RK0107	Chip R, MCR10EZHZJ000E	R9	RK0054	Chip R, MCR10EZHZJ153E
C74	CU0066	Chip C, C2012CH1H330J	R18	RK0062	Chip R, MCR10EZHZJ473E	R10	RK0028	Chip R, MCR10EZHZJ471E
C75	CU8028	Chip C, C2012B1H103K	R19	RK0107	Chip R, MCR10EZHZJ000E	R11	RK0020	Chip R, MCR10EZHZJ151E
C76	CU0011	Chip C, C2012CH1H100D	VR1	RH0031	VR, CVR-42A-103AW1D	R13	RK0045	Chip R, MCR10EZHZJ472E
C77	CU8016	Chip C, C2012B1H102K	Q1	XT0037	Transistor, 2SC2412KT96R	R14	RK0054	Chip R, MCR10EZHZJ153E
C78	CU0011	Chip C, C2012CH1H100D	Q2	XT0038	Transistor, 2SA1037KT96R	R15	RK0059	Chip R, MCR10EZHZJ333E
C79	CU8028	Chip C, C2012B1H103K	X1	XQ0021	X'Tal DSMAT 3.58 MHz	R16	RK0025	Chip R, MCR10EZHZJ331E
C80	CU2051	Chip C, C2012SL471K	IC2	XA0084	IC, MPD4020BG-T1	R17	RK0054	Chip R, MCR10EZHZJ153E
C81	CU8016	Chip C, C2012B1H102K	IC3	XA0085	IC, MPD4069BG-T1	R18	RK0062	Chip R, MCR10EZHZJ473E
C82	CU8028	Chip C, C2012B1H103K	Tone Squelch Unit			R19	RK0025	Chip R, MCR10EZHZJ331E
C84	CU8028	Chip C, C2012B1H103K				R1	RK0062	Chip R, MCR10EZHZJ473E
C85	CU8028	Chip C, C2012B1H103K	R2	RK0062	Chip R, MCR10EZHZJ473E	R21	RK0039	Chip R, MCR10EZHZJ222E
C93	CE0051	Chemical C, 16 V 1000 $\mu$ F MS16	R3	RK0039	Chip R, MCR10EZHZJ222E	R22	RK0056	Chip R, MCR10EZHZJ223E
C96	CE0125	Chemical C, 25 V 4.7 $\mu$ F MS7	R4	RK0073	Chip R, MCR10EZHZJ224E	R23	RK0054	Chip R, MCR10EZHZJ153E
C97	CE0030	Chemical C, 16 V 10 $\mu$ F MS7	R5	RK0062	Chip R, MCR10EZHZJ473E	R24	RK0037	Chip R, MCR10EZHZJ152E
C98	CU8016	Chip C, C2012B1H102K	R6	RK0031	Chip R, MCR10EZHZJ681E	R25	RK0031	Chip R, MCR10EZHZJ681E
C100	CU8016	Chip C, C2012B1H102K	R7	RK0052	Chip R, MCR10EZHZJ103E	R26	RK0048	Chip R, MCR10EZHZJ682E
C101	CE0030	Chemical C, 16 V 10 $\mu$ F MS7	R8	RK0052	Chip R, MCR10EZHZJ103E	R27	RK0056	Chip R, MCR10EZHZJ223E
C102	CU8016	Chip C, C2012B1H102K	R9	RK0039	Chip R, MCR10EZHZJ222E	R28	RK0035	Chip R, MCR10EZHZJ102E
C103	CE0199	Chemical C, 16 V 100 $\mu$ F MS7	R10	RK0086	Chip R, MCR10EZHZJ105E	R31	RK0011	Chip R, MCR10EZHZJ470E
C104	CU8028	Chip C, C2012B1H103K	R11	RK0062	Chip R, MCR10EZHZJ473E	R32	RK0052	Chip R, MCR10EZHZJ103E
C105	CU8016	Chip C, C2012B1H102K	R12	RK0022	Chip R, MCR10EZHZJ221E	D1	XD0078	Diode, DAN235KT96
C106	CU8016	Chip C, C2012B1H102K	R13	RK0052	Chip R, MCR10EZHZJ103E	D2	XD0078	Diode, DAN235KT96
C107	CU8016	Chip C, C2012B1H102K	R14	RK0050	Chip R, MCR10EZHZJ822E	X1	XQ0031	X'Tal UM-1 57.7777 MHz
C108	CU8016	Chip C, C2012B1H102K	R15	RK0039	Chip R, MCR10EZHZJ222E	Q1	XT0030	Transistor, 2SC3356T1
C109	CU8016	Chip C, C2012B1H102K	R16	RK0071	Chip R, MCR10EZHZJ154E	Q2	XT0030	Transistor, 2SC3356T1
C113	CU8028	Chip C, C2012B1H103K	R17	RK0053	Chip R, MCR10EZHZJ123E	Q3	XT0030	Transistor, 2SC3356T1
C114	CU0006	Chip C, C2012CH1H050C	R18	RK0050	Chip R, MCR10EZHZJ822E	Q4	XT0030	Transistor, 2SC3356T1
C115	CU0061	Chip C, C2012CH1H120J	R19	RK0035	Chip R, MCR10EZHZJ102E	Q5	XT0030	Transistor, 2SC3356T1
C116	CU0006	Chip C, C2012CH1H050C				Q6	XT0030	Transistor, 2SC3356T1
C117	CU0061	Chip C, C2012CH1H120J				TC1	CT0020	Trimmer C, CV38A2001
C118	CU0064	Chip C, C2012CH1H220J				TC2	CT0020	Trimmer C, CV38A2001
C119	CU8028	Chip C, C2012B1H103K						
C120	CS0033	Chip Tantal, TMC1A225TR						
C121	CU8016	Chip C, C2012B1H102K						
C141	CU0071	Chip C, C2012CH1H101J						
C142	CU0071	Chip C, C2012CH1H101J						
C143	CU0071	Chip C, C2012CH1H101J						
C144	CU0071	Chip C, C2012CH1H101J						
TC2	CT0023	Trimmer C, ECRLA006A12						
TC3	CT0025	Trimmer C, ECRLA020E12						

Part Code	Part Name and Number
CT0020	Trimmer C, CV38A2001
CT0017	Trimmer C, CV38A0301
CT0017	Trimmer C, CV38A0301
CT0017	Trimmer C, CV38A0301
CT0018	Trimmer C, CV38A0601
CT0019	Trimmer C, CV38A1001
CT0019	Trimmer C, CV38A1001
CU0064	Chip C, C2012CH1H220J
CU0009	Chip C, C2012CH1H080D
CU0060	Chip C, C2012CH1H470J
CU0002	Chip C, C2012CH1H010C
CU0060	Chip C, C2012CH1H470J
CU0004	Chip C, C2012CH1H030C
CU8016	Chip C, C2012B1H102K
CU0071	Chip C, C2012CH1H101J
CU0064	Chip C, C2012CH1H220J
CU0002	Chip C, C2012CH1H010C
CU8028	Chip C, C2012B1H103K
CU0063	Chip C, C2012CH1H180J
CU0002	Chip C, C2012CH1H010J
CU8016	Chip C, C2012B1H102K
CU8016	Chip C, C2012B1H102K
CU8026	Chip C, C2012B1H103K
CU0006	Chip C, C2012CH1H050C
CU0003	Chip C, C2012CH1H020C
CU0003	Chip C, C2012CH1H020C
CU0008	Chip C, C2012CH1H050C
CU0001	Chip C, C2012CH1H0R5C
CU0051	Chip C, C2012CH1H471K
CU0006	Chip C, C2012CH1H050C
CU8016	Chip C, C2012B1H102K
CU0009	Chip C, C2012CH1H080D
CU0071	Chip C, C2012CH1H101J
CU0066	Chip C, C2012CH1H330J
CU0062	Chip C, C2012CH1H150J
CU0061	Chip C, C2012CH1H120J
CU0004	Chip C, C2012CH1H030C
CU0061	Chip C, C2012CH1H120J
CU8016	Chip C, C2012B1H102K
CU0004	Chip C, C2012CH1H030C
CU8016	Chip C, C2012B1H102K
CU8016	Chip C, C2012B1H102K
CU8028	Chip C, C2012B1H103K
CU8028	Chip C, C2012B1H103K
CU8028	Chip C, C2012B1H103K
QK0037	Coil, 3x2.5T
QK0037	Coil, 3x2.5T
QA0046	Coil, 30R8MIF
QK0036	Coil, 3x1.5T
QK0036	Coil, 3x1.5T
QK0005	Coil, 3x3T
QA0048	Coil, 58MOSC
QA0047	Coil, 177MTC
QA0047	Coil, 177MTC
RD0108	JPW01 R-01
RD0108	JPW01 R-01

**UHF PA Unit**

RD1008	R, 1/2 W 150Ω
RD0052	R, 1/4 W 10K R20
CU0051	Chip C, C2012CH1H471K
CE0044	Chemical C, 16 V 10 μF MS5
CU0051	Chip C, C2012CH1H471K
CF0044	Chemical C, 16 V 10 μF MS5
CU7014	Chip C, UC232H0060D-T
CU0051	Chip C, C2012CH1H471K
CU0051	Chip C, C2012CH1H471K
CC5014	Ceramic C, HM60SJSJL040C
CU0005	Chip C, C2012CH1H040C
CC5019	Ceramic C, HM60SJSJL150J
CC5020	Ceramic C, HM60SJSJL180J
CC5021	Ceramic C, HM60SJSJL220J
CC0101	Ceramic C, 50 V 0.5 pF CH

Ref. No.	Part Code	Part Name and Number
C14	CU0051	Chip C, C2012CH1H471K
C15	CC5014	Ceramic C, HM60SJSJL040C
C16	CU7018	Chip C, VC232H0180J-T
C17	CC5014	Ceramic C, HM60SJSJL040C
C18	CU0051	Chip C, C2012CH1H471K
C19	CU0051	Chip C, C2012CH1H471K
C21	CU0002	Chip C, C2012CH1H010C
C25	CU8016	Chip C, C2012B1H102K
C26	CU0005	Chip C, C2012CH1H040C (DR-510E only)
VR1	RH0049	VR, TM64K2PV101B
L1	QK0044	Coil, 3x9R5x0R5
L2	QK0038	Coil, 3x1R5x0R7
L3	QK0040	Coil, 3x3R5x0R6
L4	QK0038	Coil, 3x1R5x0R7
L5	QK0038	Coil, 3x1R5x0R7
L6	QC0051	Inductor FL4H1R0
Q1	XA0077	IC, M57788M
D2	XD0106	Diode, UM9401
D3	XD0014	Diode, M1308
D4	XD0102	Diode, ISS101
D5	XD0102	Diode, ISS101

**VHF PA Unit**

R1	RD1008	R, 1/2 W 150Ω
R2	RD0054	R, 1/4 W 15 kΩ
C1	CE0044	Chemical C, 16 V 10 μF MS5
C2	CE0044	Chemical C, 16 V 10 μF MS5
C3	CC5002	Ceramic C, 500 V 10 pF SL
C4	CC5020	Ceramic C, HM60SJSJL180J
C5	CC5025	Ceramic C, HM60SJSJYB102K
C6	CC5020	Ceramic C, HM60SJSJL180J
C7	CC5023	Ceramic C, HM60SJSJL390J
C8	CC0102	Ceramic C, 50 V 1 pF CH
C9	CC5003	Ceramic C, 500 V 33 pF SL
C10	CC0102	Ceramic C, 50 V 1 pF CH
C11	CC5021	Ceramic C, HM60SJSJL220J
C12	CU8016	Chip C, C2012B1H102K
C13	CU8016	Chip C, C2012B1H102K
C14	CU8016	Chip C, C2012B1H102K
C15	CU8016	Chip C, C2012B1H102K
C16	CU8016	Chip C, C2012B1H102K
D1	XD0107	Diode, G3B
D2	XD0106	Diode, UM9401
D3	XD0014	Diode, M1308
D4	XD0095	Diode, 1S2472
D5	XD0095	Diode, 1S2472
IC1	XA0043	IC, M57726
L1	QK0044	Coil, 3x9R5x0R5
L2	QK0031	Coil, 3x6T
L3	QK0041	Coil, 3x4R0x0R8
L4	QK0044	Coil, 3x9R5x0R5
L5	QK0041	Coil, 3x4R0x0R8
L6	QK0041	Coil, 3x4R0x0R8
L7	QC0051	Inductor, FL4H1R0
VR1	RH0049	VR, TM64K2PU101B

**Duplexer Unit**

R1	RK0039	Chip R, MCR10EZHZJ222E
R2	RK0069	Chip R, MCR10EZHZJ104E
R3	RK0069	Chip R, MCR10EZHZJ104E
C1	CC5022	Ceramic C, HM60SJSJL270D
C2	CC5022	Ceramic C, HM60SJSJL270D
C3	CU7012	Chip C, UC232H0040C-T
C4	CU0051	Chip C, C2012CH1H471K

Ref. No.	Part Code	Part Name and Number
C5	CU0051	Chip C, C2012CH1H471K
C6	CC5016	Ceramic C, HM60SJSJL080D
C7	CC5015	Ceramic C, HM60SJSJL060D
C8	CC5015	Ceramic C, HM60SJSJL060D
C9	CU0011	Chip C, C2012CH1H100D
C10	CU0051	Chip C, C2012CH1H471K
C11	CS0049	Chip Tantal, TMC1C105TR
C12	CU8016	Chip C, C2012B1H102K
C13	CU0005	Chip C, C2012CH1H040C
L1	QK0055	Coil, 3x6Tx0.8
L2	QK0055	Coil, 3x6Tx0.8
L3	QK0054	Coil, 3x1.75Tx0.8
L5	QK0054	Coil, 3x1.75Tx0.8
L6	QK0054	Coil, 3x1.75Tx0.8
RL1	UL0006	Relay, AG201344
Q1	XT0037	Transistor, 2SC2412KT96R

**Dual Control Unit**

R1	RK0035	Chip R, MCR10EZHZJ102E
R2	RK0062	Chip R, MCR10EZHZJ473E
R3	RK0062	Chip R, MCR10EZHZJ473E
R4	RK0052	Chip R, MCR10EZHZJ103E
R5	RK0018	Chip R, MCR10EZHZJ101E
R6	RK0067	Chip R, MCR10EZHZJ823E
R7	RK0071	Chip R, MCR10EZHZJ154E
R8	RK0067	Chip R, MCR10EZHZJ823E
R9	RK0059	Chip R, MCR10EZHZJ333E
R10	RK0052	Chip R, MCR10EZHZJ103E
R11	RK0062	Chip R, MCR10EZHZJ473E
R12	RK0062	Chip R, MCR10EZHZJ473E
R13	RK0062	Chip R, MCR10EZHZJ473E
R14	RK0062	Chip R, MCR10EZHZJ473E
R15	RK0062	Chip R, MCR10EZHZJ473E
R16	RK0062	Chip R, MCR10EZHZJ473E
R17	RK0062	Chip R, MCR10EZHZJ473E
R18	RK0062	Chip R, MCR10EZHZJ473E
R19	RK0062	Chip R, MCR10EZHZJ473E
R20	RK0062	Chip R, MCR10EZHZJ473E
R21	RK0062	Chip R, MCR10EZHZJ473E
R22	RK0062	Chip R, MCR10EZHZJ473E
R23	RK0062	Chip R, MCR10EZHZJ473E
R24	RK0062	Chip R, MCR10EZHZJ473E
R25	RK0062	Chip R, MCR10EZHZJ473E
R26	RK0045	Chip R, MCR10EZHZJ472E
R27	RK0070	Chip R, MCR10EZHZJ124E
R28	RK0070	Chip R, MCR10EZHZJ124E
R29	RK0070	Chip R, MCR10EZHZJ124E
R30	RK0070	Chip R, MCR10EZHZJ124E
R31	RK0062	Chip R, MCR10EZHZJ473E
R35	RK0052	Chip R, MCR10EZHZJ103E
R36	RK0052	Chip R, MCR10EZHZJ103E
R37	RK0045	Chip R, MCR10EZHZJ472E
R38	RK0069	Chip R, MCR10EZHZJ104E
R39	RK0035	Chip R, MCR10EZHZJ102E
R42	RK0069	Chip R, MCR10EZHZJ104E
R43	RK1035	Chip R, MCR18EZHZJ102E
R44	RK0052	Chip R, MCR10EZHZJ103E
R47	RK0018	Chip R, MCR10EZHZJ101E
R48	RK0062	Chip R, MCR10EZHZJ473E
R49	RK0062	Chip R, MCR10EZHZJ473E
R50	RK0038	Chip R, MCR10EZHZJ182E
R51	RK0038	Chip R, MCR10EZHZJ182E
R52	RK0038	Chip R, MCR10EZHZJ182E
R53	RK0038	Chip R, MCR10EZHZJ182E
R54	RK0038	Chip R, MCR10EZHZJ182E
R55	RK1039	Chip R, MCR18EZHZJ222E
R56	RK0035	Chip R, MCR10EZHZJ102E
R57	RK0107	Chip R, MCR10EZHZJ000E (DR-510T only)
R58	RK0035	Chip R, MCR10EZHZJ102E
R59	RK0035	Chip R, MCR10EZHZJ102E
R60	RK0035	Chip R, MCR10EZHZJ102E
R61	RK0035	Chip R, MCR10EZHZJ102E
R62	RK0035	Chip R, MCR10EZHZJ102E



## ■ ADJUSTMENT (VHF)

Item	Adjustment point	Adjustment method
VCO P/D Voltage (RX)	TC2 (VCO Box)	Adjust TC2 so that the voltage of TP3 is 4V on the receiving mode.
VCO P/D Voltage (TX)	TC1 (VCO Box)	Adjust TC1 so that the voltage of TP3 is 3V on the transmission mode.
Frequency	TC2 (Main Board)	Set the unit in the transmission mode at 145.00 MHz and adjust TC2.
Power output	VR6 (Hi)	On "HI" position, turn VR6 for 45 W output at 145.00 MHz.
	VR7 (Lo)	On "LO" position, turn VR7 for 5 W output at 145.00 MHz.
RF Power Meter	VR4	Turn VR4 so that three segments will light on "LO" position.
Deviation	VR3	Input a signal of 1 KHz/25 mV into the MIC jack and adjust VR3 so that you obtain 4.9 KHz/Dev in the transmission mode.
MIC Gain	VR2	Input a signal of 1 KHz/10 mV into the MIC jack and adjust VR2 so that you obtain 4.0 KHz/Dev in the transmission mode.
Protection Circuit	VR5	Disconnect the antenna in the transmission mode and adjust VR5 so that the current consumption will be 5A.
Subaudible Tone Deviation (DR-510T)	VR1 (Tone squelch board)	On the "ENC" mode at 146.00 MHz, turn VR1 so that the deviation is 0.7 KHz.
1750 Hz Tone Deviation (DR-510E)	VR1 (Tone burst board)	Pressing Tone button at 145.00 MHz, turn VR1 so that the deviation is 3.5 KHz.
S-Meter (SG output: 3 dB $\mu$ EMF)	VR1	Turn VR1 so that the <input type="checkbox"/> begins to light.
Squelch Sensitivity (SG output: -6 dB $\mu$ EMF)	VR9	Turn the squelch control fully clockwise and turn VR9 so that the squelch will be closed at the SG output of -6 dB $\mu$ .

### Upper Side View

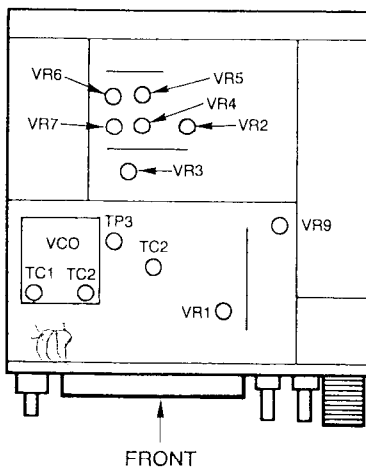

## ■ ADJUSTMENT (UHF)

Item	Adjustment point	Adjustment method
VCO P/D Voltage (RX)	TC2 (VCO Box)	Adjust TC2 so that the voltage of TP3 is 2 V on the receiving mode.
VCO P/D Voltage (TX)	TC1 (VCO Box)	Adjust TC1 so that the voltage of TP3 is 1 V on the transmission mode.
Frequency	TC3 (Main Board)	Set the unit in the transmission mode at 435.00 MHz (T: 445.00 MHz) and adjust TC3.
Power output	VR6 (Hi)	On "HI" position, turn VR6 for 35 W output at 435 (T: 445) MHz.
	VR7 (Lo)	On "LO" position, turn VR7 for 5 W output at 145.00 MHz.
RF Power Meter	VR4	Turn VR4 so that three segments will light on "LO" position.
Deviation	VR3	Input a signal of 1 KHz/25 mV into the MIC jack and adjust VR3 so that you obtain 4.9 KHz/Dev in the transmission mode.
MIC Gain	VR2	Input a signal of 1 KHz/10 mV into the MIC jack and adjust VR2 so that you obtain 4.0 KHz/Dev in the transmission mode.
Protection Circuit	VR5	Disconnect the antenna in the transmission mode and adjust VR5 so that the current consumption will be 4A.
Subaudible Tone Deviation (DR-510T)	VR1 (Tone squelch board)	On the "ENC" mode at 435.00 MHz, (T: 445.00 MHz), turn VR1 so that the deviation is 0.7 KHz.
1750 Hz Tone Deviation (DR-510E)	VR1 (Tone burst board)	Pressing Tone button at 435.00 MHz (T: 445.00 MHz), turn VR1 so that the deviation is 3.5 KHz.
S-Meter (SG output: 3 dB $\mu$ EMF)	VR1	Turn VR1 so that the <input type="checkbox"/> begins to light.
Squelch Sensitivity (SG output: -6 dB $\mu$ EMF)	VR9	Turn the squelch control fully clockwise and turn VR9 so that the squelch will be closed at the SG output of -6 dB $\mu$ .

### Lower Side View

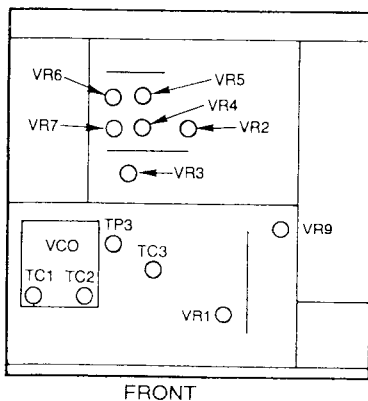

# BLOCK DIAGRAM

DH510 T/E BLOCK DIAGRAM

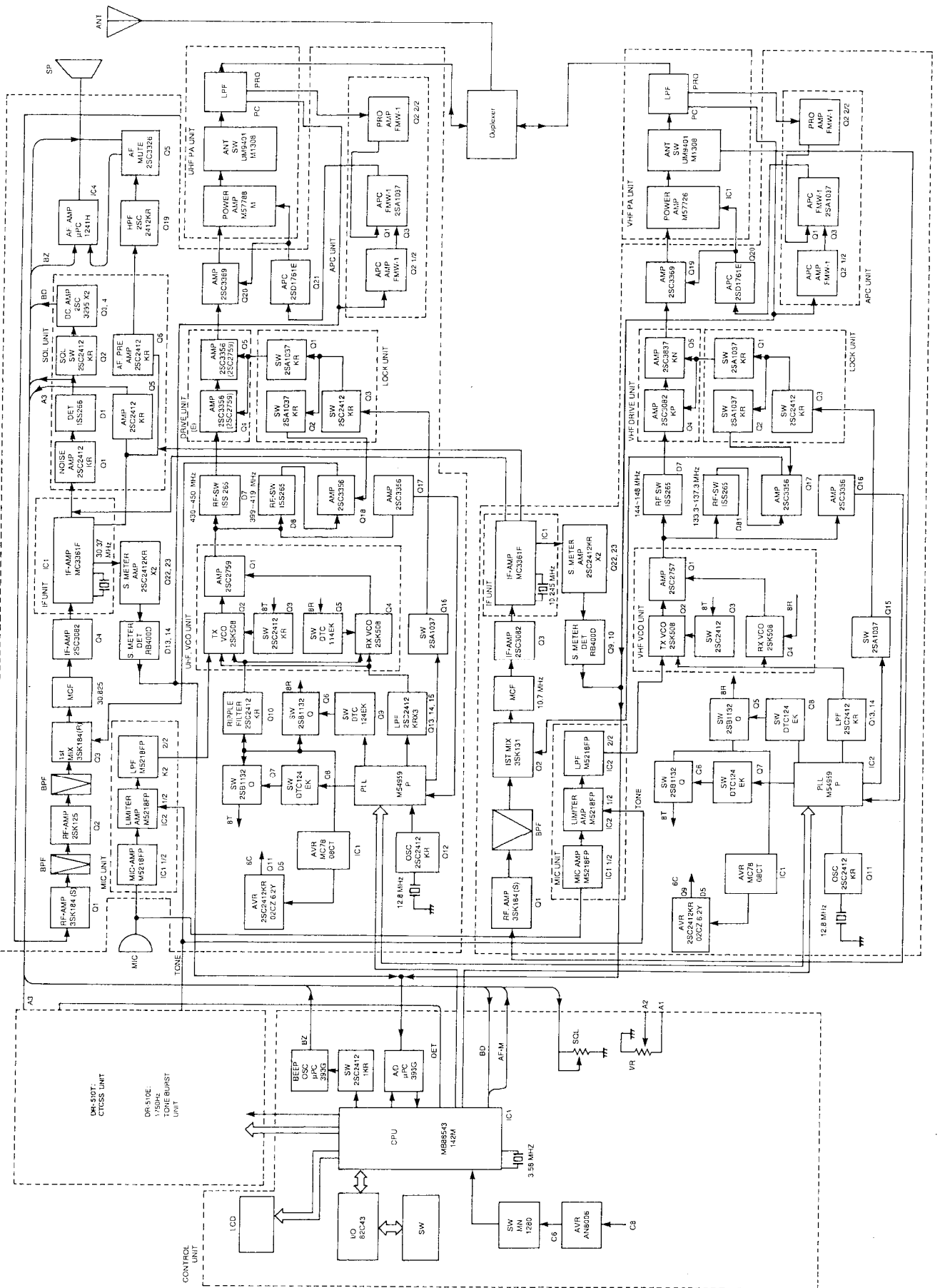

# CONNECTION DIAGRAM

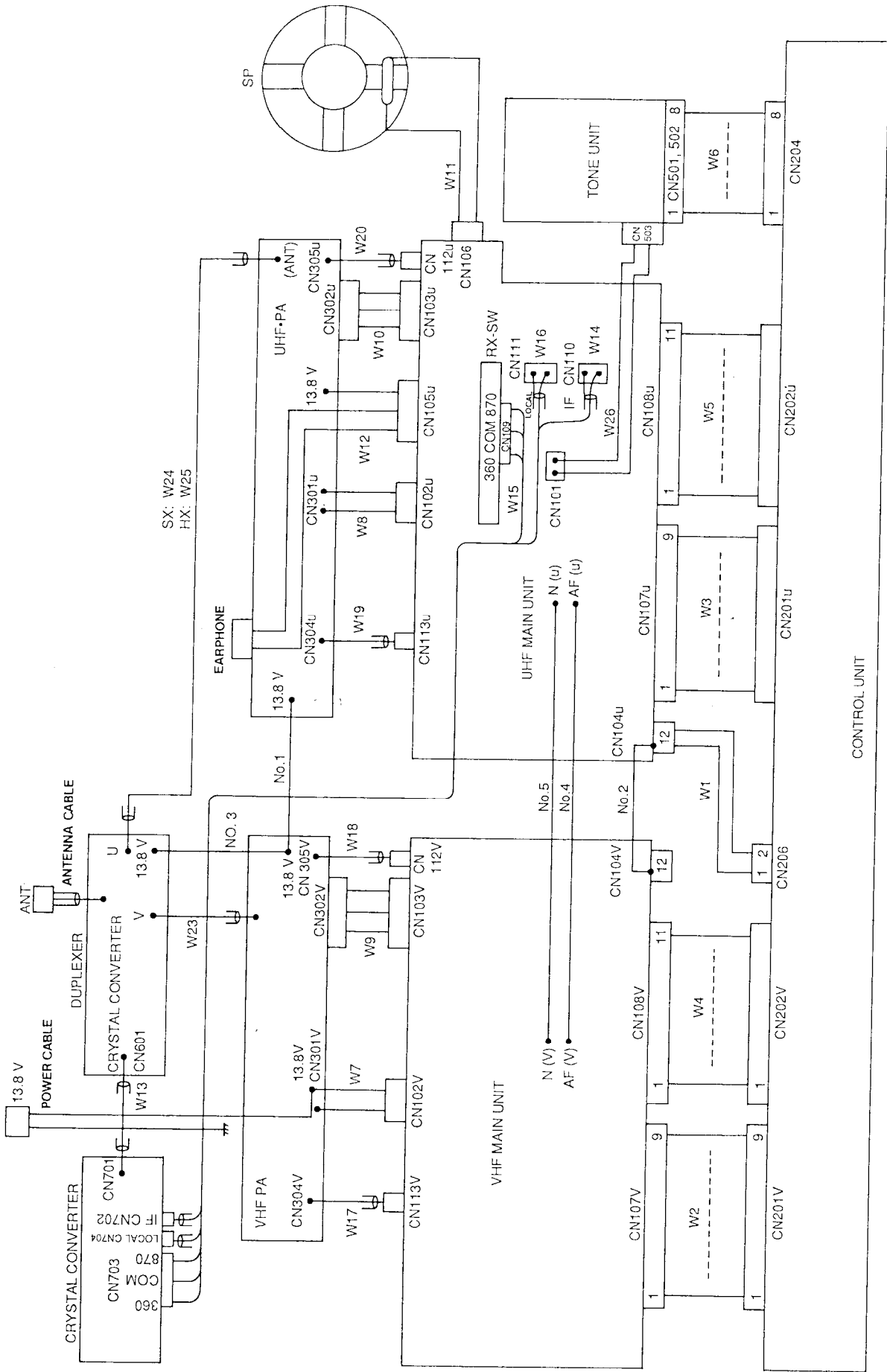

**VHF MAIN SCHEMATIC DIAGRAM**

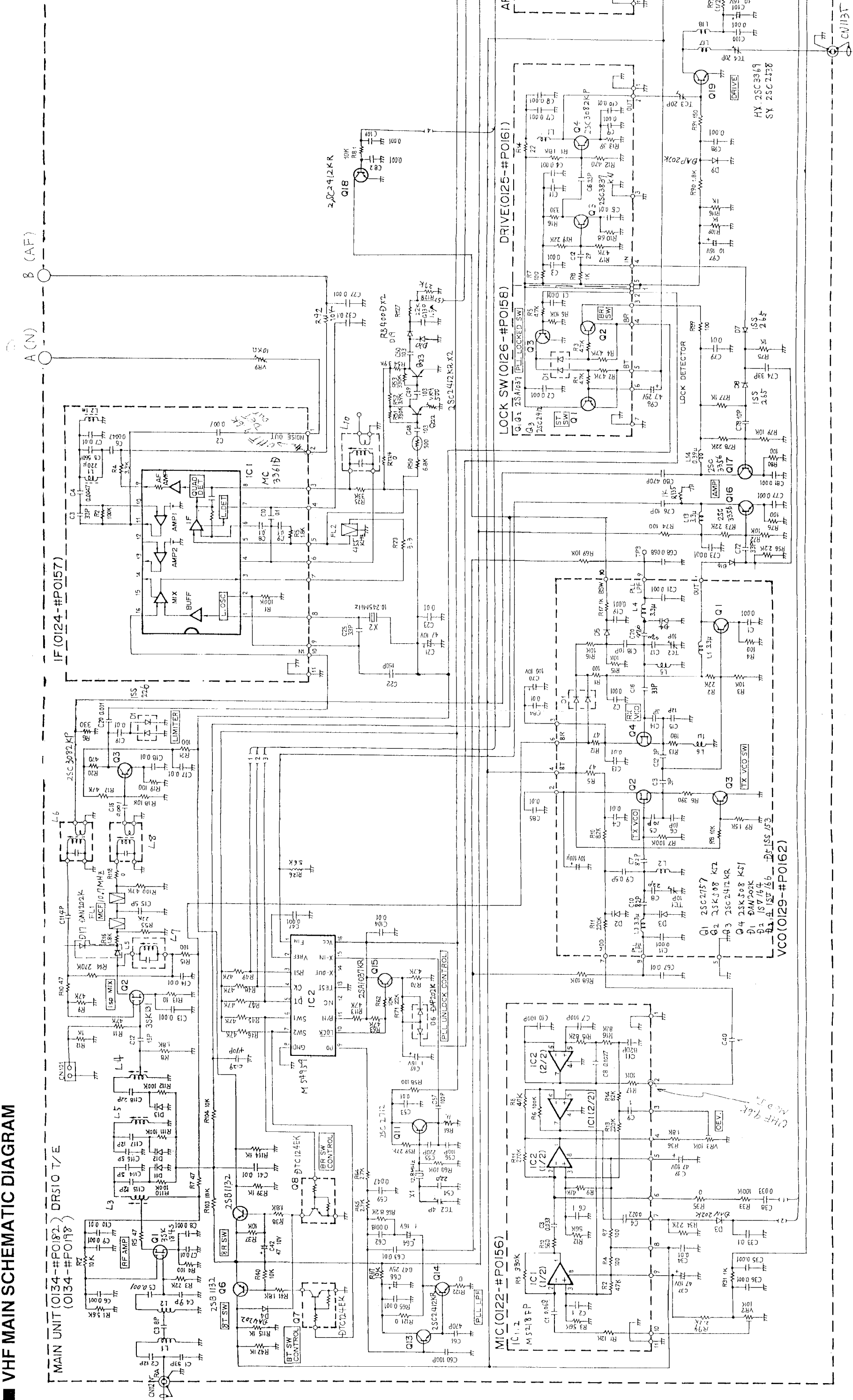

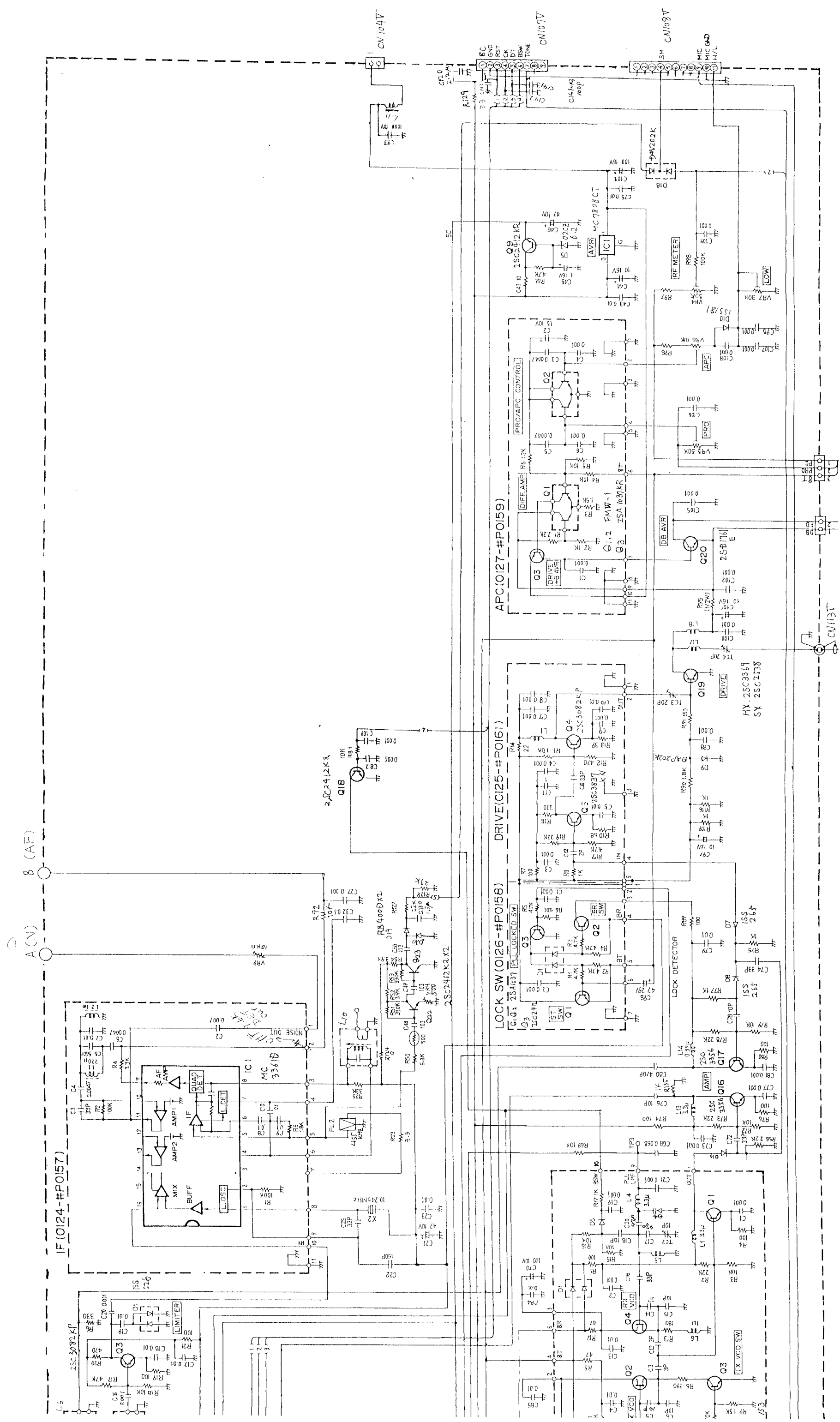









# VHF PA AND MAIN PC BOARD

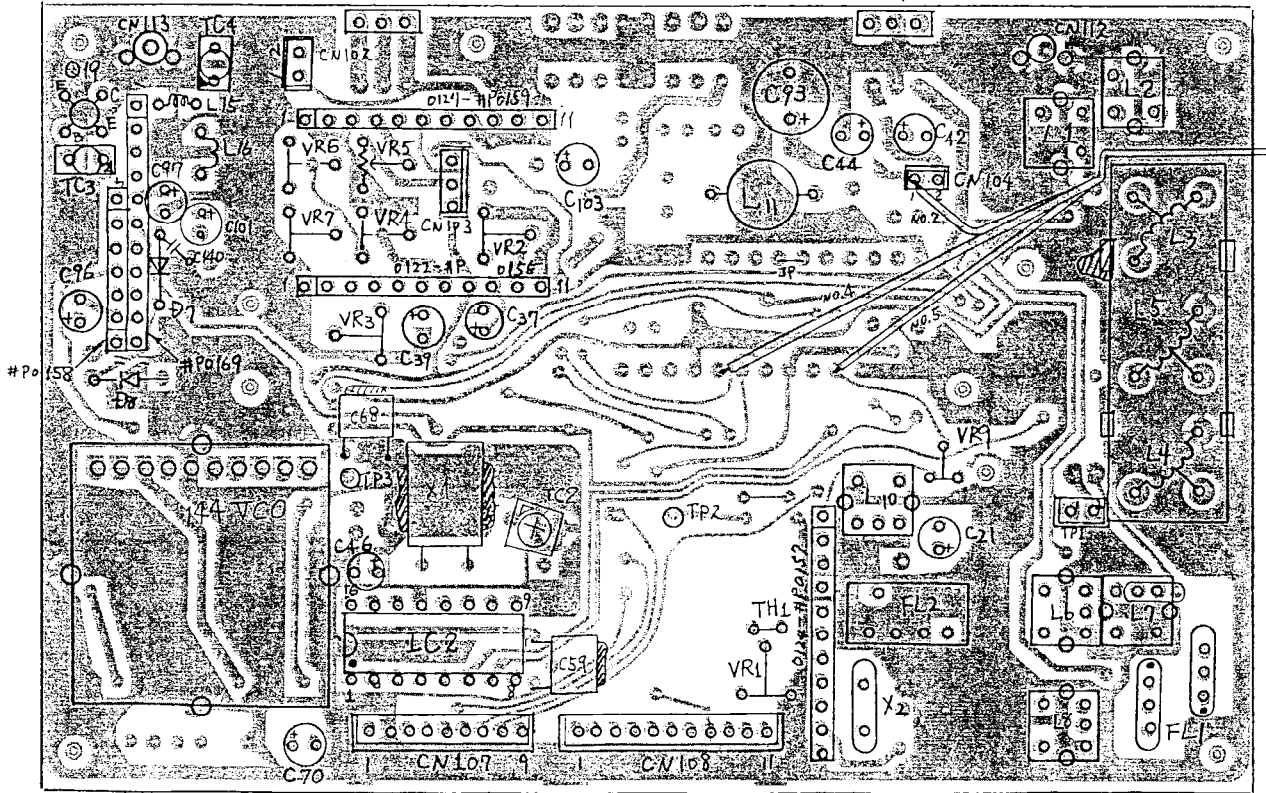
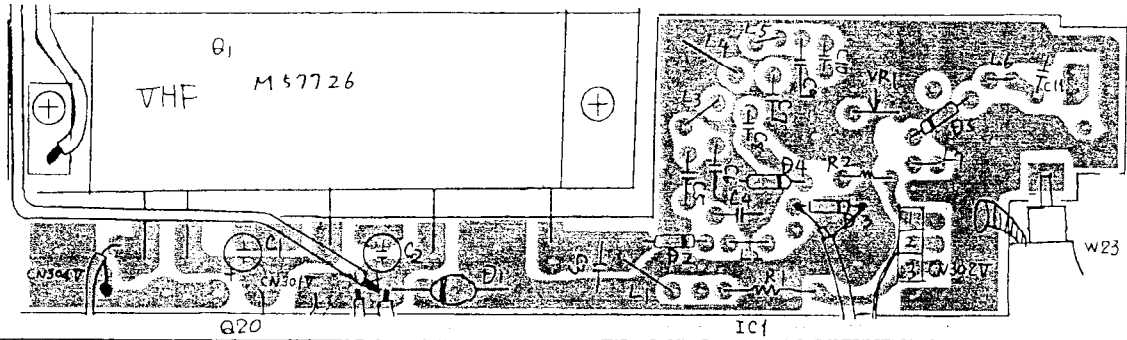

(Part)

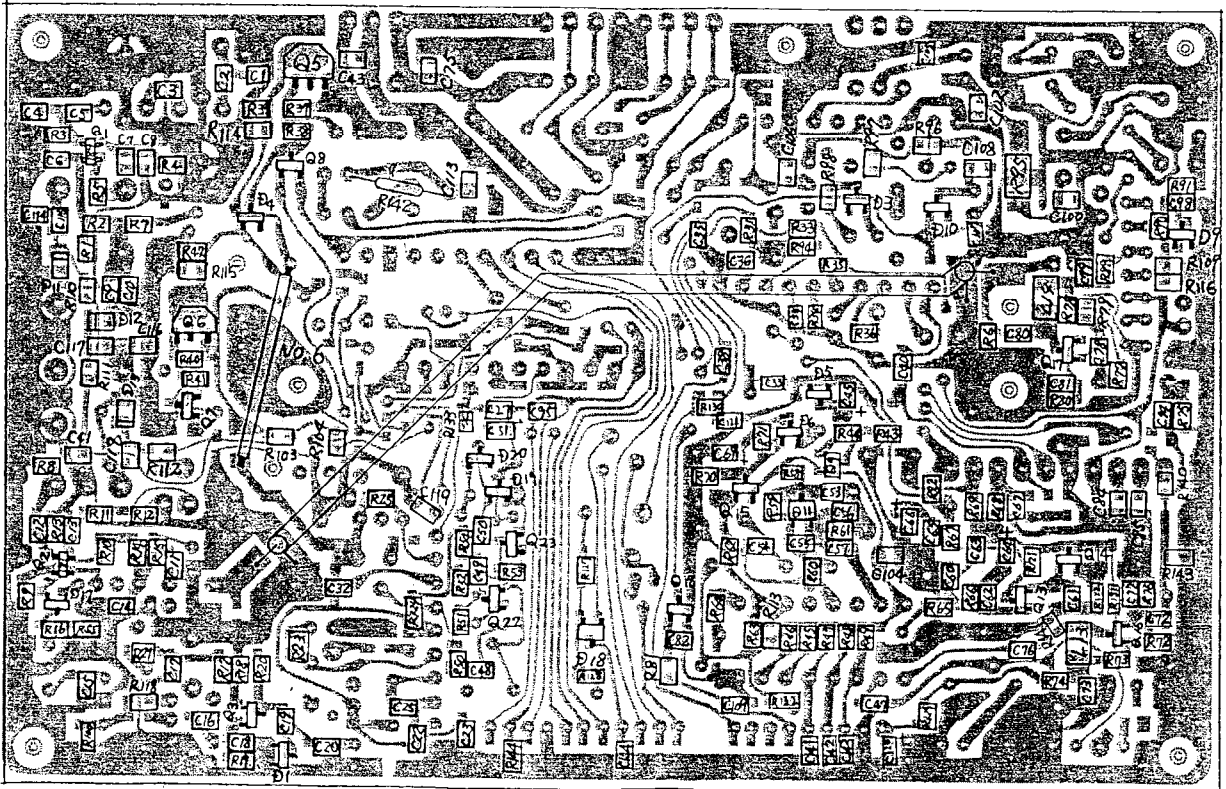
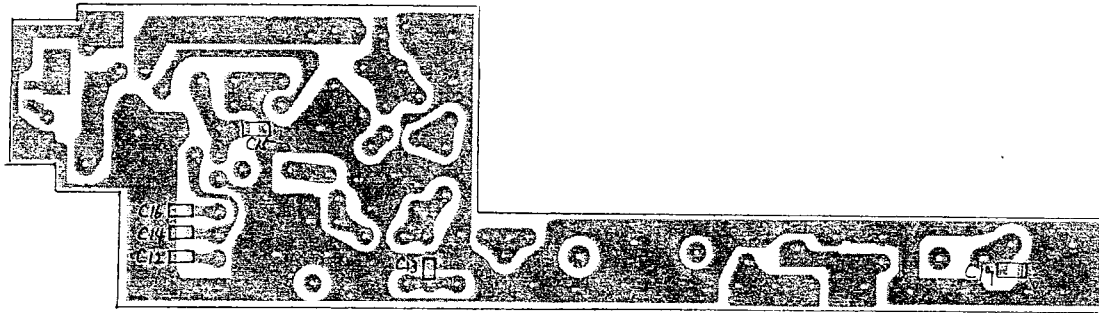

(Solder)

# UHF PA AND MAIN PC BOARD

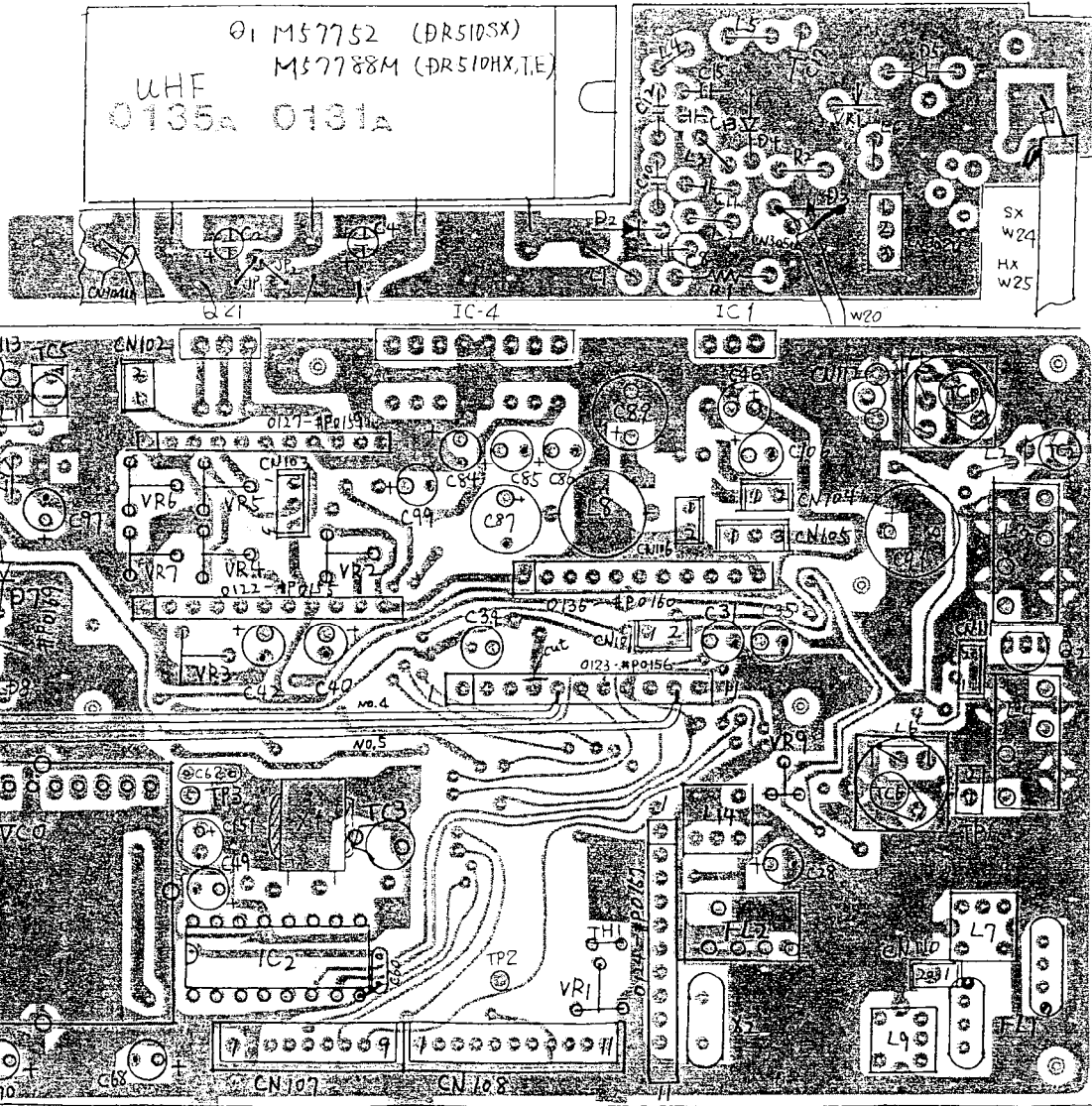

(Part)







■ X'CON PC BOARD

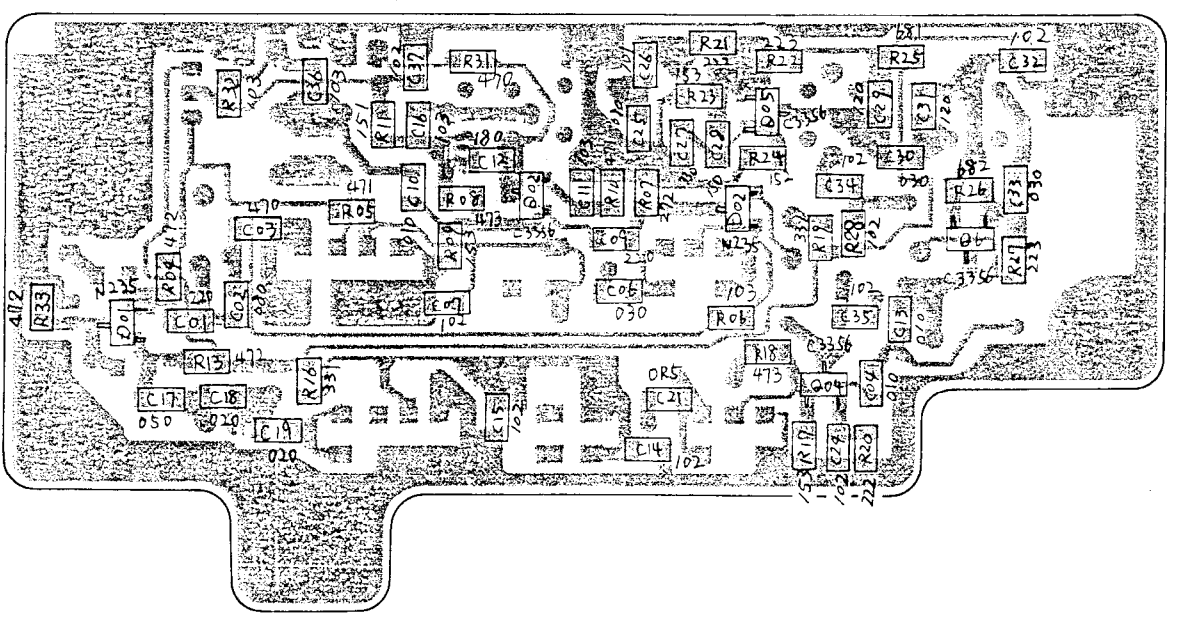
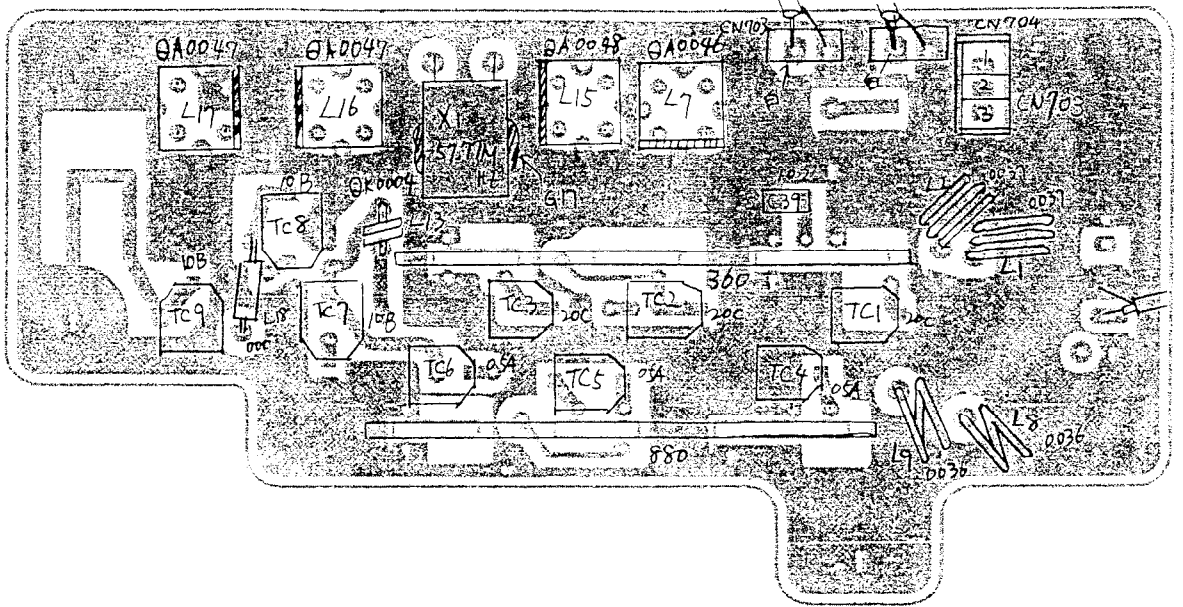



## ■ TONE BURST UNIT CIRCUIT DIAGRAM

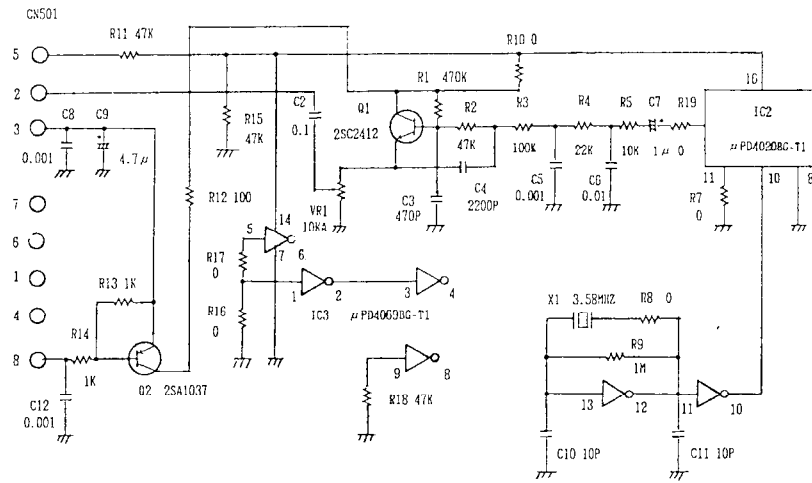

## ■ TONE BURST PC BOARD

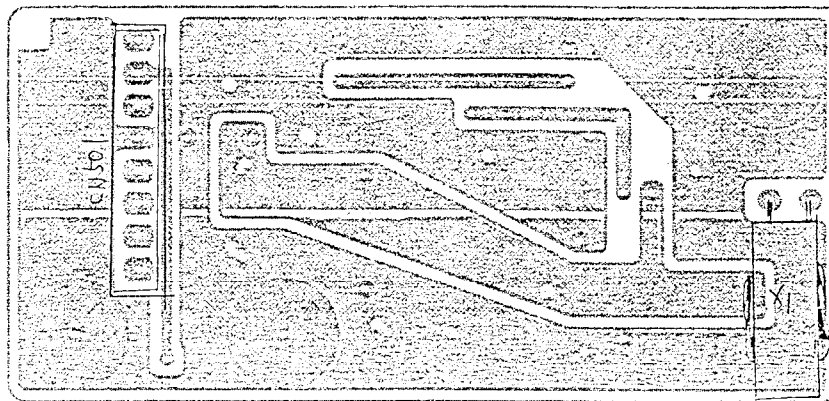
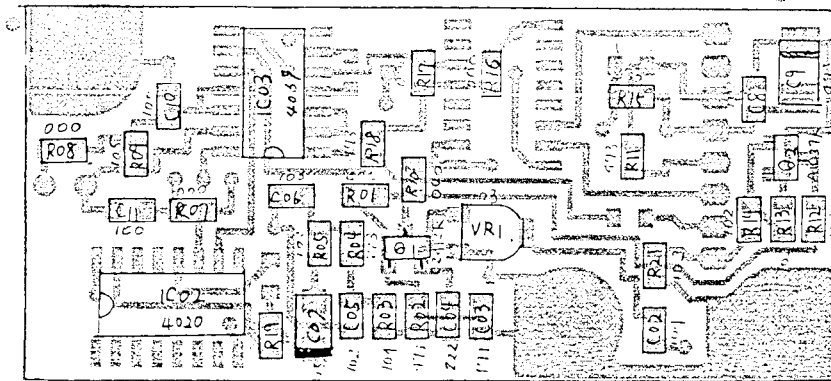

■ APC PC BOARD

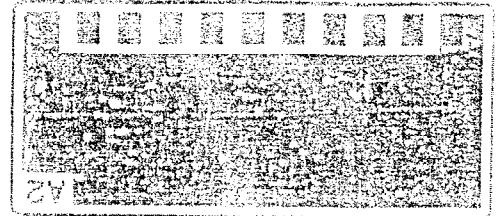
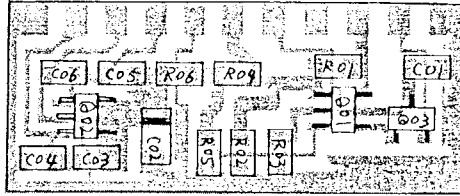

■ VHF VCO PC BOARD

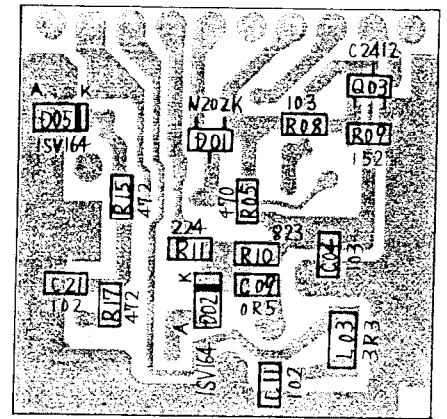
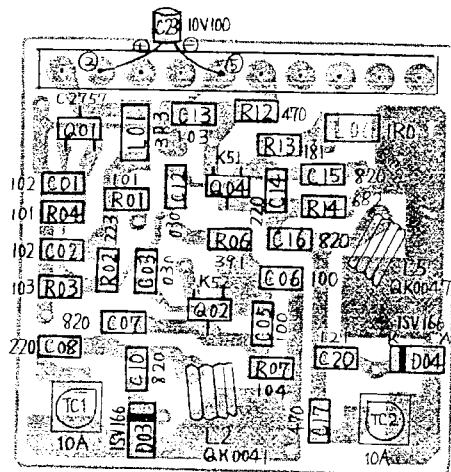

■ UHF VCO PC BOARD

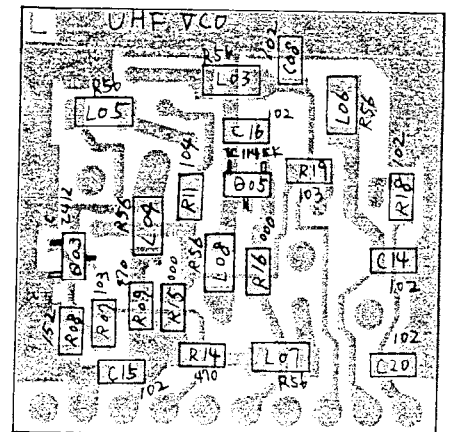
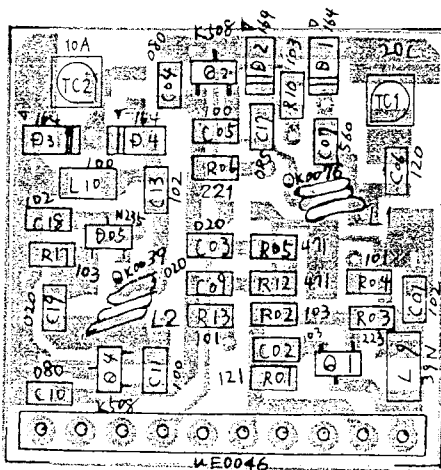



## ■ VHF DRIVE PC BOARD

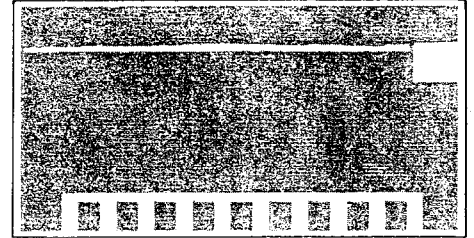
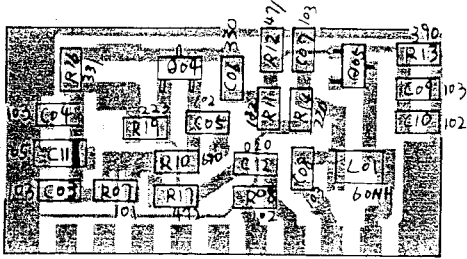

## ■ UHF DRIVE PC BOARD

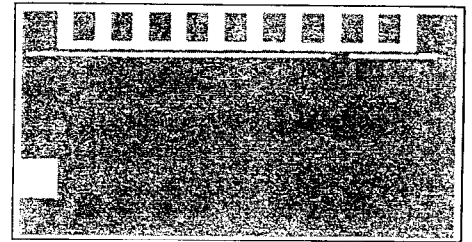
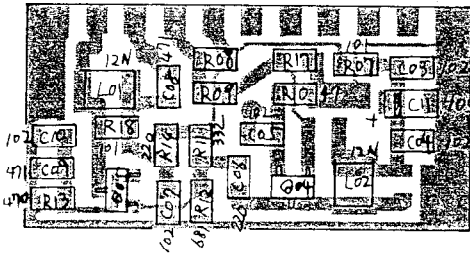

## ■ IF PC BOARD

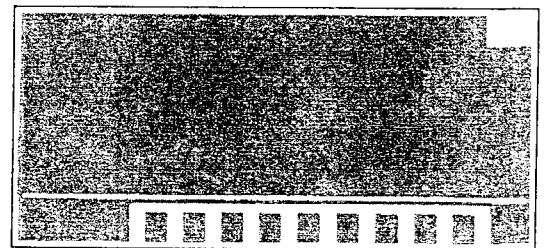
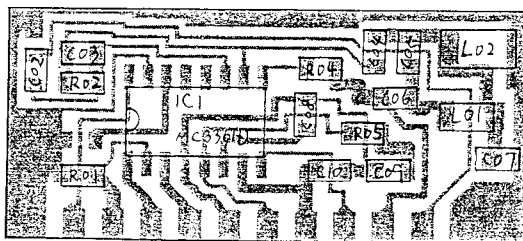

■ RX SW PC BOARD

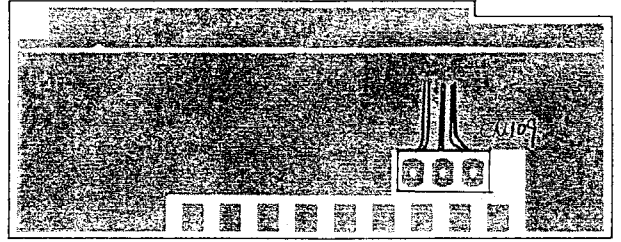
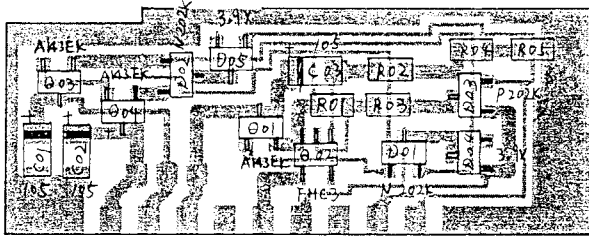

■ MIC PC BOARD

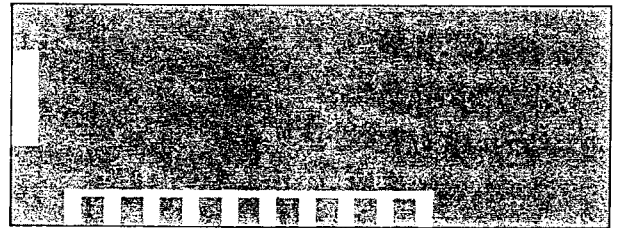
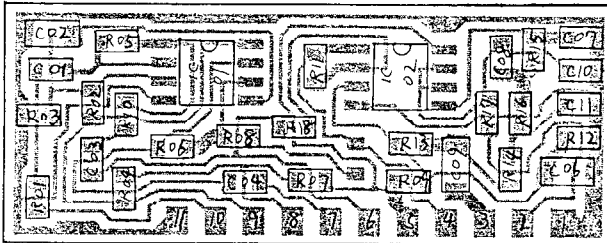

■ LOCK SW PC BOARD

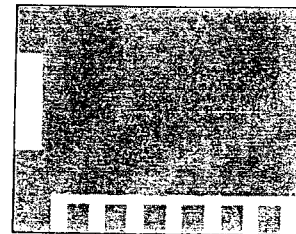
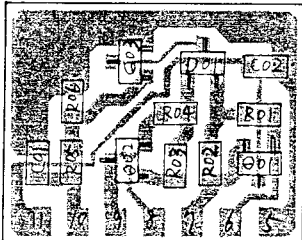



## **ALINCO ELECTRONICS INC.**

**Head Office:** "TWIN 21" MID Tower Building 23F  
1-61, 2-Chome, Shiromi, Chuo-ku, Osaka No. 540, Japan  
**Factory:** 1-1-1, Mishimae, Takatsuki, Osaka No. 569, Japan



## **ALINCO ELECTRONICS INC.**

20705 S. Western Ave., Suite 104 Torrance Ca. 90501, U.S.A.  
Phone: 213-618-8616

Dealer/Distributor