



1. ALIGNMENT PROCEDURE

TEST EQUIPMENT REQUIRED

- |                           |                   |
|---------------------------|-------------------|
| SINAD Meter               | Distortion Meter  |
| Digital Voltmeter         | Analog Voltmeter  |
| Oscilloscope              | Frequency Counter |
| Standard Signal Generator |                   |
| DC Power Supply           | VTVM              |

1-0. PREPARATION FOR ALIGNMENT

- Power Supply
  - DC voltage (Batt. Terminal) : 6.5V (6.4V~6.6V)
  - AC voltage (Batt. Pack voltage jack using AC Adapter/charger) : 120V (108V~132V) 60Hz
- Power Switch : OFF
- Volume : MINIMUM (FULL CCW)
- Squelch : MINIMUM (FULL CW)

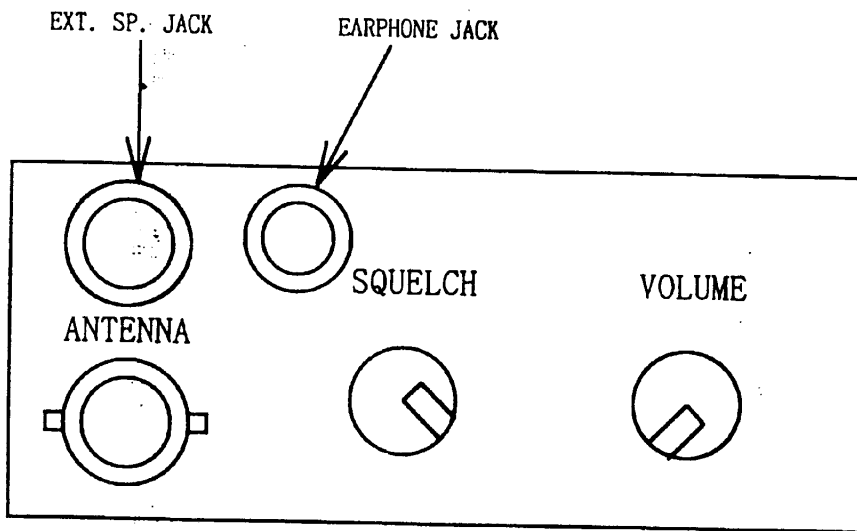

Figure 1. TOP VIEW OF THE UNIT



REVISIONS:	REV. CODE	△	△	△	△	△	△	△	△	△	△	△	△	△	△	△	△
	DATE	01/08/25															
	LOT # / RMN	1A117A4 / 12542															
	REVISED BY	[Signature]															
CHECKED BY	[Signature]																

6.12.27  
E 54-2699

1-1-1. CHANGE TO THE LCD CHECK MODE

Turn on the power switch by pressing "2", "9" and "L/O" keys simultaneously then confirm that LCD DISPLAY indicate all LCD segment(Fig. 2).

Figure 2. LCD segment

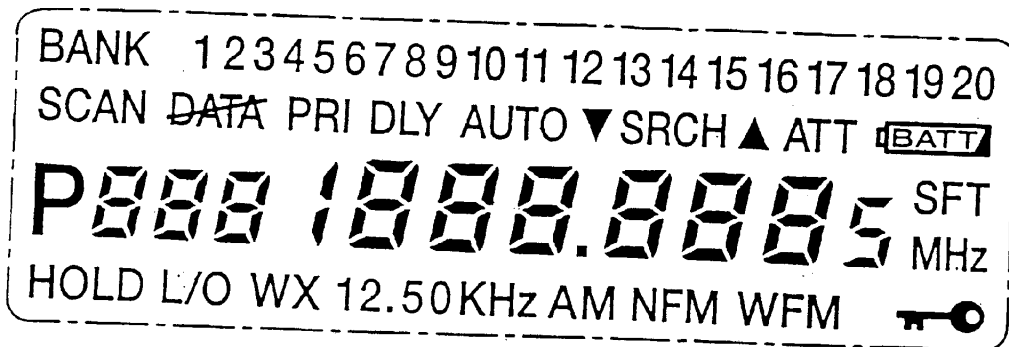

REVISIONS:	REV. CODE	△	△	△	△	△	△	△	△	△	△	△	△	△	△	△	△	△	△	△	
	DATE	010325																			
	LOT # / RM	INITIAL / LCM																			
	REVISED BY	✓																			
CHECKED BY	✓																				

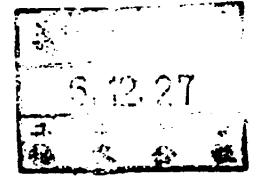
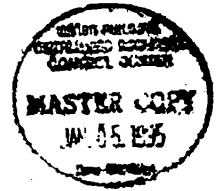

E 54-2699





2. PCB ALIGNMENT

2-1. PREPARATION FOR ALIGNMENT

· Power Supply

DC voltage (Batt. Terminal) : 6.5V (6.4V~6.6V)

AC voltage (Batt. Pack voltage jack

using AC Adapter/charger) : 120V (108V~132V) 60Hz

· SIGNAL : NFM: 1KHz,  $\pm 3$  KHz deviation

WFM: 1KHz,  $\pm 22.5$  KHz deviation

AM : 1kHz,  $\pm 60$  % deviation

REVISIONS:				
REV CODE	LOT # /RNN	DATE	REV BY	CHK BY
0	INITIAL			
1	PD 3488 95-004 95-092	21/09/95		
2	PD 3488 95-010	27/09/95		

STEP	PRESET TO	ADJUSTMENT	REMARKS
1	CH 21 (25.100 MHz) CH 24 (249.600 MHz) CH 25 (249.700 MHz) CH 14 (1299.9125 MHz)	No Alignment	* VCO 1 & VCO 2 CHECKING · Connect digital voltmeter to TP1. · Check VCO VOLTAGE. CH 21: 1.6 $\pm$ 0.8V DC CH 24: 14.5 $\pm$ 2.0V DC (12.5 ~ 16.5VDC) CH 25: 3.0 $\pm$ 1.2V DC CH 14: 14.1 $\pm$ 2.0V DC
2	CH 14 (1299.9125 MHz)	CT 2	* VCO 3 ADJUSTMENT · Connect digital voltmeter to TP2. · ADJUST CT2 to 2.5V $\pm$ 0.05V DC.
3	CH 12 (765.250 MHz)	No Alignment	* VCO 3 CHECKING · Check TP2 VOLTAGE. CH 12: 1.1V $\pm$ 0.3V DC
4	CH 14 (1299.9125 MHz)	CT 1	* REF. OSC ADJUSTMENT · Connect frequency counter to TP4. · ADJUST CT1 to 322.6125 MHz $\pm$ 100 Hz
5	CH 3 (62.450 MHz) SSG: 62.450 MHz 100 $\mu$ V, MOD. OFF	L208	* WFM DISCRI. ADJUSTMENT. · Connect digital voltmeter to TP202. · ADJUST L208 to 1.2V $\pm$ 0.05V DC.
6	CH 3 (62.450 MHz) SSG: 62.450 MHz 1.5 $\mu$ V, WFM	L206	* WFM IF ADJUSTMENT · ADJUST L206 for maximum SINAD meter reading. (Reduce SSG Level for better adjustment.)
7	CH 2 (40.840 MHz) SSG: 40.84 MHz 100 $\mu$ V, MOD. OFF	L204	* NFM DISCRI. ADJUSTMENT · Connect digital voltmeter to TP203. · ADJUST L204 to 1.5V $\pm$ 0.05V



6.12.27

2699

8	CH 5 (127.175MHz) SSG: 127.175 MHz 0.4 μV, MOD AM 60% VOL: MAX.	L201	*NFM/AM IF ADJUSTMENT • ADJUST L201 for maximum Audio output.
9	CH 5 (127.175MHz) SSG: 127.175 MHz 20 μV, MOD AM 60%	VR201	*AGC ADJUSTMENT • Connect analog voltmeter to TP201. • ADJUST VR201 to 1.0V ± 0.5V DC.
10	CH 5 (127.175MHz) SSG: 127.175 MHz 18.8 μV or 21.1 μV MOD AM 60%	No Alignment	*AGC CHECKING • Connect analog voltmeter to TP201. • Check analog voltmeter reading deflects to the right(SSG output at 18.8 μV) and left(SSG output at 21.1 μV) from adjusted position.
11	CH 2 (40.840 MHz) SSG: 40.84 MHz 0.90 μV (TYP.) MOD NFM SQ: CCW	VR202	* SQ ADJUSTMENT • Connect probe to TP205. (See figure 3) Then measure DC voltage. 0.90V ± 0.02V (Adjust SSG output level if voltage is not 0.90V ± 0.02V) • Turn VR202 fully COUNTERCLOCKWISE until Audio output disappears. • Then ADJUST VR202 slowly CLOCKWISE to a point where Audio output appears.
12	CH1 CH2 CH3 CH4 CH5 CH6 CH7 CH8 CH9 CH10 CH11 CH12 CH13 CH14	No Alignment	* SENSITIVITY CHECKING • Check 12dB SINAD SENSITIVITY. CH1: < 1.2 μV CH2: < 0.8 μV CH3: < 6.0 μV CH4: < 1.2 μV CH5: < 1.2 μV CH6: < 0.8 μV CH7: < 6.0 μV CH8: < 1.2 μV CH9: < 1.2 μV CH10: < 0.95 μV CH11: < 6.0 μV CH12: < 1.2 μV CH13: < 1.2 μV CH14: < 1.2 μV

REVISIONS:				
REV CODE	LOT # /RNN	DATE	REV BY	CHCK BY
0	INITIAL ISSUE	01/27/95	/	3/21/95
△				
△				
△				
△				
△				
△				
△				
△				
△				
△				
△				
△				
△				
△				
△				

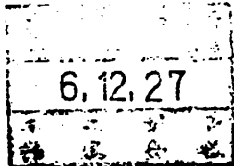
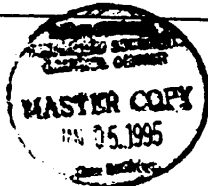

E 54-2699



3. FUNCTION CHECK

NOTICE: Right after microprocessor is soldered to PCB, turn power switch to on by pressing "2", "9" and "MANUAL" keys simultaneously. There is no need to do memory clear mode once the above procedure is done.

STEP	PRESS	REMARKS
1	2, 9, L/O keys simultaneously.	Power on confirm LCD display showing all LCD segment.
2		Power switch off.
3	2, 9,  keys simultaneously.	Power on confirm LCD display showing ROM number(EX.989bh) then "EUR" and version number (EX.1.02) display appears.
4		Power switch off.
5	2, 9, SCAN keys simultaneously.	Power on confirm LCD display showing "ubc 3000" then "25.500 MHz" display appears with bank 1 blinking at SCAN mode.
6	MANUAL	CH. 1 at bank 1. "SCAN" display disappears.
7	1 2 3 4 . 5 6 7 8 E	Confirm a "1234.5625 MHz" display (12.5KHz step NFM).
8	9 8 7 . 9 0 E	Confirm a "987.900 MHz" display (12.5KHz step NFM).
9	DLY (x2)	"DLY" display appears and disappears.
10	L/O (x2)	"L/O" display appears and disappears.
11	ATT (x2)	"ATT" display appears and disappears.
12	PRI (x2)	"PRI" display appears and disappears.
13	LHT (x2)	LCD back lights on then off.
14	STP (x4)	Confirm step frequency blinking and changing to 25, 50, 5, 12.5KHz display on LCD.
15	25, LMT, 54, LMT	"54.000 MHz" display with CH. "1" and "12.5KHz" blinking.
16	SRC	"SRCH▲" and "25.000 MHz" display with CH. "1" blinking at AM.
17	HLD (x2)	"Hold" display appears then an increment of 5KHz while CH. "1" blink.
18	LMT	Confirm decrement of 5KHz with CH. "1" blinking. "▼SRCH" display appears.





REVISIONS:				
REV CODE	LOT # /RNN	DATE	REV BY	CHCK BY
△ 10	INITIAL			
△	KLIVE	0102K		
△				
△				
△				
△				
△				
△				
△				
△				
△				
△				
△				
△				
△				
△				

6.12.27



E 54-2699

8/26

19	AUTO, 3	Confirm a "25.000 MHz" display with CH. "1", "AUTO" and all banks (1-20) are blinking except bank 3. "DATA" display appears.
20	DATA	"DATA" display disappears.
21	SRC	Confirm a "▼SRCH" display with "AUTO", bank "3" and CH. "1" blinking as channel memory increments until "FULL" display appears.
22		Confirm a "53.910 MHz" display at CH.60 bank 3.
23	SND (×2)	Confirm "CH" display is blinking.
24	2, HLD	Confirm alternative display of CH.60 and CH. 2 at banks 3 and 1 respectively.
25	E	Confirm CH. 60 memory frequency is transferred to CH. 2.
26	6, 0, MANUAL	Confirm a "000.000" display at CH.60.
27	2, MANUAL	Confirm a "53.910 MHz" display at CH. 2.
26	SND	Confirm that "BANK" is blinking.
27	5, E	Confirm that CH. 2 memory frequency is transferred to CH. 81 at bank 5.
28	2, MANUAL	Confirm a "000.000" display at CH. 2.
29	SND	Confirm an "Error" display appears on LCD.
30	[·] (×2)	Confirm that "Error" display disappears on LCD. Then back to "000.000" display.
31	8, 1, MANUAL	Confirm that CH. 2 memory frequency is transferred to CH. 81.
32	 for 2 sec.	Confirm "  " display when a beep tone is heard. There is no change in LCD display on key button input.
33	 for 2 sec.	Confirm "  " display disappears when a beep tone is heard. Key buttons already function.
34	[·] , STP (SFT), (AM)	Confirm "NFM" display disappears and "AM" display appears with blinking.
35	[·] , AUTO (SFT), (NFM)	Confirm "AM" display disappears and "NFM" display appears.
36	[·] , SND (SFT) (WFM)	Confirm "NFM" display disappears and "WFM" display appears with blinking.
37		Power switch off.
38	2, 9, MANUAL Simultaneously.	Power on confirm "000.000" display on LCD for all channels.

REVISIONS:				
REV CODE	LOT # /RNN	DATE	REV BY	CHCK BY
△	INITIAL			
△	LSLUE			
△				
△				
△				
△				
△				
△				
△				
△				
△				
△				
△				
△				
△				
△				
△				



6.12.27

E54-2609

9/26

4. TURBO SEARCH / WINDOW DETECTOR / DATASKIP TEST

PRESET TO

SQUELCH: Tight (Fully counterclockwise)

SIGNAL : NFM: 1KHz,  $\pm 3$ KHz deviation, 20  $\mu$ V

WFM: 1KHz,  $\pm 22.5$ KHz deviation, 100  $\mu$ V

MODE : SEARCH

STEP	REMARKS
1	• Turn on the power switch while pressing "2", "9" and "E" keys simultaneously. Press "SRC" to start searching. Then press "DATA" to deactivate data function. Confirm that the unit will stop searching at 173.225MHz (input from SSG).
2	• Press "TRBO" to activate turbo function ("SRCH" start blinking). Then press "SRC" to start searching. Confirm that the unit will stop searching at 173.225MHz(input from SSG). Press " TRBO " again to deactivate turbo function("SRCH" stop blinking).
3	• Confirm also that searching will stop at 173.225MHz $\pm 5$ KHz when 173.225MHz $\pm 4.8$ KHz is entered into the SSG.
4	• Press "DATA" to activate dataskip function. Confirm that the unit stop at 173.225MHz when modulation off. Confirm that the unit start searching after about 2 seconds. While dataskip function still on, set SSG to external modulation at $\pm 4$ KHz deviation and set AF generator to 600Hz, square wave. The unit should stop searching at 173.225MHz (SSG input frequency). Confirm that searching continues after about 2 seconds.
5	• Turn on the power switch while pressing "2", "9" and "L/O" keys simultaneously. Press "SRC" to start searching. Then press "DATA" to deactivate data function. Confirm that unit will stop searching at 511.9125MHz (input from SSG). Then confirm that searching will stop at 511.9125MHz $\pm 12.5$ KHz when 511.9125MHz $\pm 12$ KHz is entered into the SSG.
6	• Turn on the power switch while pressing "2", "9" and "SCAN" keys simultaneously. Press "SRC" to start searching. Then press "DATA" to deactivate data function. Confirm that unit will stop searching at 531.5MHz (input from SSG). Then confirm also that searching will stop at 531.5MHz $\pm 50$ KHz when 531.5MHz $\pm 46$ KHz is entered into the SSG.
7	• Press "DATA" to activate data function. Confirm that the unit stop at 531.5MHz. Then modulation off. Confirm that the unit start searching after about 2 seconds.



REVISIONS:	REV. CODE	△	△	△	△	△	△	△	△	△	△	△	△	△	△	△
	DATE	01/02/95	2/08/95													
	LOT # / RNN	INITIAL	PD 9489													
	REVISED BY	1/5/95	95-02													
	CHECKED BY															

E 54-2699

12.27

10/26

TABLE 2. VCO 1 AND VCO 2 VOLTAGE (at TP 1)

CH	FREQUENCY	STEP	MODE	VCO VOLTAGE
1	25.500 MHz	5 KHz	AM	1.6 ± 0.8V
2	40.840 MHz	5 KHz	NFM	2.8 ± 1.0 V
3	62.450 MHz	50 KHz	WFM	4.5 ± 1.0 V
4	108.500MHz	12.5KHz	AM	7.5 ± 1.0 V
5	127.175MHz	12.5KHz	AM	8.6 ± 1.0 V
6	162.400MHz	5 KHz	NFM	10.4 ± 1.5V
7	195.500MHz	50 KHz	WFM	12.0 ± 1.5V
8	230.050MHz	12.5KHz	AM	13.8 ± 1.5V
9	325.050MHz	12.5KHz	AM	12.2 ± 1.5V
10	453.250MHz	12.5KHz	NFM	6.3 ± 1.0 V
11	531.500MHz	50 KHz	WFM	9.3 ± 1.0 V
12	765.250MHz	12.5KHz	NFM	8.7 ± 1.0 V
13	954.9125MHz	12.5KHz	NFM	11.9 ± 1.5V
14	1299.9125MHz	12.5KHz	NFM	14.1 ± 2.0 V

REVISIONS:				
REV CODE	LOT # /RNN	DATE	REV BY	CHK BY
10	INITIAL ISSUE			By [Signature]
△				
△				
△				
△				
△				
△				
△				
△				
△				
△				
△				
△				
△				
△				
△				
△				
△				
△				
△				
△				
△				

FIGURE 3 SQ ADJUSTMENT

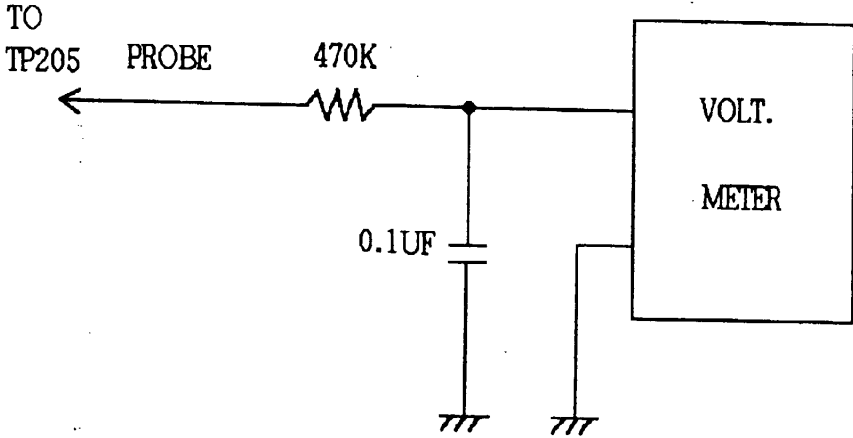
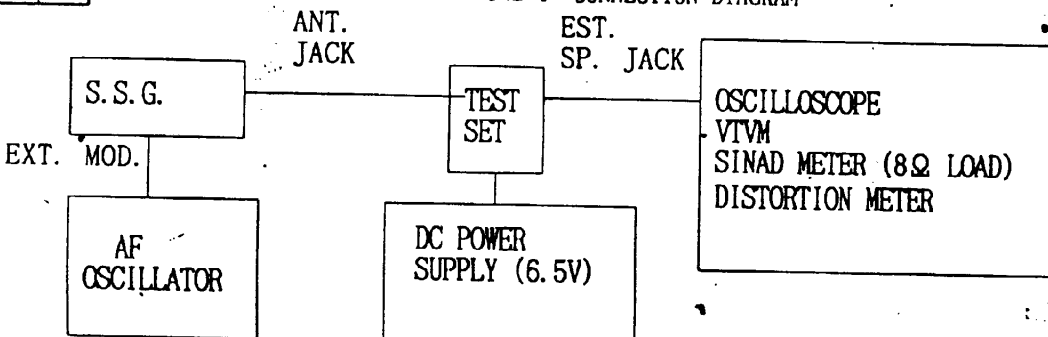

FIGURE 4 CONNECTION DIAGRAM



6 12 27

E 54-2699





12/26

5. GENERAL OPERATIONAL TESTS

5-1. ANTENNA TEST

Keep the unit in the receiving status, pull out the ANT. plug from the terminal and mount the telescopic rod antenna.

Bring the end of the ANT. plug (disconnected previously) near the rod antenna and confirm that the unit returns to the receiving status. Change the length of the rod antenna and check if there is no oscillation problem.

5-2. HOWLING TEST

There must be no howling under the conditions described below, or no strange, loud sounds produced when the unit is tapped or pushed with fingers.

Measuring Conditions:

SSG: 1mV, Mod. Off

Volume Control: Set at 10% THD in standard modulation.

Note: Set at the maximum position if less than 10% THD.

5-3. ELECTROSTATIC DISCHARGE (ESD) TEST

a) Test Method

Based on the General Standards for ESD test.

Tested in 2 ways; By applying the power to the unit through an AC Adaptor and another is by pulling out the DC power jack.

For discharging the electrostatics, use the antenna with a 1M ohm resistor.

b) Testing Points and Conditions

Based Points and Conditions

Applied only to the exposed metal parts and operational portions.

c) Judging Standards

(1) No damage is done (when the DC power jack is connected).

(2) No memory blank, damage, etc. (when the power is switched on).

It will be judged as acceptable if the unit starts scanning or temporarily error which can be corrected by pressing the MANUAL key or turning the power switch on and off.

d) Setting Up

Based on the General Standards for ESD test.

The Provided antenna is mounted and the EXT. SP. jack is open.

e) Equipment To Be Used

ELECTROSTATIC SIMULATOR (MODEL ESS-625S)

± 15kv 150pF 500Ω

MEMORY CLEAR

Press keys 2, 9, and MANUAL keys simultaneously, and turn the power switch on. Confirm that all the channels display 000.0000MHz.

REVISIONS:				
REV CODE	LOT # /RNN	DATE	REV BY	CHCK BY
0	INITIAL	1-11-82	CHD/MC	[Signature]
△				
△				
△				
△				
△				
△				
△				
△				
△				
△				
△				
△				
△				
△				
△				
△				

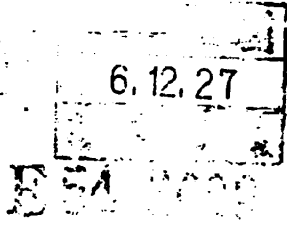

13/26

### 6. Test Mode

UBC3000XLT has following the Test Mode.

Test Mode function works only first times when you press TEST MODE key(as like [2][9][L/O] key) and turn to power on.

Test Mode is shown as below.

No.	Keys Operation	Action
1	[2][9][SCAN]+Power On	Program the Test Frequency Search Limit=531.0-532.0MHz Battery Save Function=Off
2	[2][9][MANUAL]+Power On	Initial All Memory Battery Save Function=On
3	[2][9][L/O]+Power On	LCD Segment Check
4	[2][9][LCK]+Power On	Display Country Code and Check SUM
5	[2][9][E]+Power On	Search Limit=173.0-173.3MHz
6	[2][9][L/O]+Power On	Search Limit=511.5-512.0MHz
7		

#### 6.1. Program Test Frequency([2][9][SCAN])

Test Frequency are programmed into Channel Memory. Their frequency is used to check hard ware.

Test frequency are followings.

CH	Frequency	CH	Frequency
1	25.5000	21	25.1000
2	40.8400	22	139.2000
3	62.4500	23	139.3000
4	108.5000	24	249.6000
5	127.1750	25	249.7000
6	162.4000	26	269.2000
7	195.5000	27	269.3000
8	230.0500	28	530.5000
9	325.0500	29	530.6000
10	453.2500	30	1299.9000
11	531.5000	31	000.0000
12	765.2500	32	000.0000
13	954.9125	33	000.0000
14	1299.9125	34	000.0000
15	000.0000	35	000.0000
16	000.0000	36	000.0000
17	000.0000	37	000.0000
18	000.0000	38	000.0000
19	000.0000	39	000.0000
20	000.0000	40	000.0000

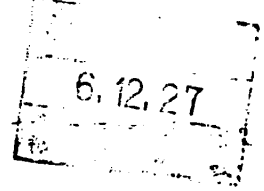

REVISIONS:	REV. CODE	△	△	△	△	△	△	△	△	△	△	△	△	△	△	△	△	△	△
	DATE	06/12/27																	
	LOT # / R/N	INITIAL																	
	REVISED BY																		
	CHECKED BY																		

E 54 56 10

14/26

**6.2. Initial All Memory([2][9][MANUAL])**

This mode is used to clear all memory at factory where unit(UBC3000XLT) is assembled.

Initial Settings

No.	Function	Initial Setting
1	CH Memory	000.0000MHz(1-400CH)
2	L/O	ALL On(1-400CH)
3	Delay a. CH Memory b. Search mode	a. Off b. On
4	Data Skip	On
5	Turbo Search(3 Step Search)	Off
6	Scan Bank	Only Bank 1
7	Search Limit	Upper:000.0000MHz Lower:000.0000MHz
8	Key Lock	Off
9	Priority Priority Channels	Off The lowest channel in each Bank (Bank 1-10)
10	Search Direction	To Upper
11	Step	Auto Step
12	Light	Off
13	Attenuator	Off
14		

**6.3. Segment Check([2][9][L/O])**

This mode need to check connection of LCD segment at factory.

**6.4. Display Country Code and Check SUM([2][9][LCK])**

This function has advantage easy to confirm soft-ware version without opening unit.

REVISIONS :	REV. CODE	△	△	△	△	△	△	△	△	△	△	△	△	△	△	△	△	△	△	△
	DATE	01/02/05																		
	LOT # / RNN	INITIAL ISSUE																		
	REVISED BY																			
	CHECKED BY																			

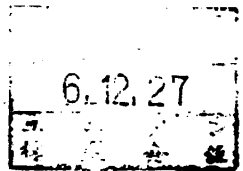

554-1110

7. SPECIFICATION

15/  
/26

SPECIFICATION

SCANNING RECEIVER MODEL : UBC3000XLT (UB-247B)

Issued : 1994/10/18

Revised:

GENERAL

- 1. Band Coverage : 13 Bands
- 2. Frequency Range :
  - 25.0000 - 25.9950 MHz ( 5 kHz STEP AM )
  - 26.0000 - 53.9950 MHz ( 5 kHz STEP NFM )
  - 54.0000 - 67.9950 MHz ( 50.0kHz STEP WFM )
  - 68.0000 - 87.9950 MHz ( 5 kHz STEP NFM )
  - 88.0000 - 107.9950 MHz ( 50.0kHz STEP WFM )
  - 108.0000 - 136.9950 MHz ( 12.5kHz STEP AM )
  - 137.0000 - 173.9950 MHz ( 5 kHz STEP NFM )
  - 174.0000 - 215.9950 MHz ( 50.0kHz STEP WFM )
  - 216.0000 - 224.9950 MHz ( 5 kHz STEP NFM )
  - 225.0000 - 399.9950 MHz ( 12.5kHz STEP AM )
  - 400.0000 - 511.9950 MHz ( 12.5kHz STEP NFM )
  - 512.0000 - 549.9950 MHz ( 50.0kHz STEP WFM )
  - 760.0000 - 1300.0000 MHz ( 12.5KHz STEP NFM )

※ User can select frequency steps (5K/12.5K/25K/50K) at all frequency range and can select modulation mode (AM/NFM/WFM) from 25.000MHz to 549.995MHz. Other frequency range have NFM and WFM only.

- 3.Channels : 400 Channels(20Ch × 20 Banks)
- 4.Display : LCD (With Back Light) 10 Digits and special Annunciator (BANK 1~20, SCAN, DATA, PRI, DLY, AUTO, ▼, SRCH, ▲, ATT, BATT, P, SFT, MHz, HOLD, L/O, 12.50KHz, AM, NFM, WFM, KEYLOCK)
- 5.Keys (PROGRAM) : Total 1 set 12 Keys
  - Numeric : "0" to "9"
  - Enter : "E"
  - Decimal/Clear : "."

REVISIONS:	REV. CODE	△	△	△	△	△	△	△	△	△	△	△	△	△	△	△	△	△
	DATE	01/23/95																
	LOT # / R/N	INITIAL ISSUE																
	REVISED BY																	
	CHECKED BY																	

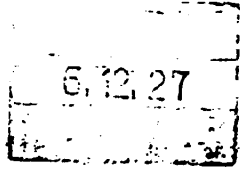

5A-9A

16/26

- (OPERATION) : Total 16 Keys
- SCAN : Start Scan
  - MANUAL : Direct channel access
  - TURBO : TURBO-SEARCH on/off
  - DLY : 2 seconds stay on frequencies
  - L/O : Channel-skip/Search-Skip on/off
  - PRI : Sample a Designated Frequency on Max.10 Priority Channel , every 2 seconds
  - LCK : Key lock on/off
  - LHT : LCD back light on/off  
(after 15 seconds, automatic light off.)
  - AUTO : Active Autostore mode
  - ATT : RF-ATT on/off
  - LMT : Set Upper/Lower freq. on Search
  - SRC : Start Search
  - HLD : Stop Search
  - STP : to manually set the frequency steps in Search mode (5KHz, 12.5KHz, 25KHz, 50KHz)
  - SND : Transfer displayed frequency to other bank
  - DATA : DATA-SKIP on/off

6. Controls/Switches : Volume Cont. with Power ON/OFF Switch  
: Spelch Cont.

7. External Jacks : ANT. Jack : BNC Type  
EXT. SPEAKER Jack : 3.5  $\phi$   
Phone Jack : 3.5  $\phi$  Stereo Type  
Charge Jack : 3.4  $\phi$  (on BP-2500)

8. Internal Speaker : 8 ohm, 0.5W (40  $\phi$ )

9. Power requirements : BP-2500 Ni-Cd Battery (6VDC, 600mAh)  
UAD-2500U (INPUT AC230V 50Hz, OUTPUT DC12V 200mA)

10. Operating TEMP. : -20°C ~ +60°C

11. Storage TEMP. : -30°C ~ +70°C

12. Size (mm) : 69.0 W X 38.5 D X 187.0 H (Without Antenna)

13. Weight : 370 g

14. Accessories : AC ADAPTER (UAD-2500U)  
Rubber Antenna(AT-218)  
Belt crip  
Owner's Manual  
Earphone(EP-009)  
Leatherlike case



REVISIONS:	REV. CODE	△	△	△	△	△	△	△	△	△	△	△	△	△	△	△	△	△
	DATE	01/03/95																
	LOT # / RNN	INITIAL ICLUB																
	REVISED BY																	
CHECKED BY																		

6.12.27

17/26

15. Heterodyne System : (1) 1<sup>st</sup> heterodyne  
 25.0000-310.9950MHz : Upper heterodyne (IF 308.675-308.700MHz)  
 311.0000-549.9950MHz : Upper heterodyne (IF 254.375-254.400MHz)  
 760.0000-805.9950MHz : Lower heterodyne (IF 254.375-254.400MHz)  
 806.0000-1300.000MHz : Lower heterodyne (IF 308.675-308.700MHz)
- (2) 2<sup>nd</sup> heterodyne (IF 58.075MHz)  
 254.375-254.400MHz : Upper heterodyne  
 308.675-380.700MHz : Lower heterodyne
- (3) 3<sup>rd</sup> heterodyne (IF 455KHz and 5.5MHz)  
 NFM and AM : Lower heterodyne (IF 455KHz)  
 WFM : Lower heterodyne (IF 5.5MHz)

16. Filter :  
 Monolithic X'tal Filter 58.0750MHz (NFM/AM)  
 Ceramic Filter 5.5MHz (WFM)  
 Ceramic Filter 455KHz (NFM/AM)

17. Scan/Search Rate :  
 Scan Max. 100 ch/Sec  
 Search Max. 100 Step/Sec  
 Turbo Search Max. 300 Step/Sec (at Step 5KHz)

18. Scan/Search Delay : Typ. 2 sec

REVISIONS:	REV. CODE	△	△	△	△	△	△	△	△	△	△	△	△	△	△	△	△	△
	DATE	01/20/27																
	LOT #/RNN	INITIAL KUE																
	REVISED BY	/																
CHECKED BY	/																	

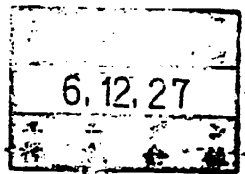

E 54-2609

18/26

MEASUREMENT CONDITIONS

1. Power Source : 6.5VDC at Battery terminal
2. Antenna Impedance : 50 ohm
3. Test Temperature : 25°C
4. Modulation Frequency : 1KHz
5. Deviation : NFM ± 3KHz Dev., WFM ±22.5KHz Dev. & AM 60%
6. Mean Signal Input Level : 1mV
7. Audio Output Load : 8 Ω resistive load (at EXT.SP JACK)
8. Standard Ref. Audio Output: 50mW (0.632V)

ITEM		UNIT	NOMINAL	LIMIT
1. Sensitivity 12dB SINAD				
NFM	at 40.8400MHz	μV	0.3	1.0
	at 162.4000MHz	μV	0.3	1.0
	at 453.2500MHz	μV	0.4	1.2
	at 765.2500MHz	μV	0.5	1.5
	at 954.9125MHz	μV	0.5	1.5
	at 1299.9125MHz	μV	0.5	1.5
WFM	at 62.4500MHz	μV	1.2	8.0
	at 195.5000MHz	μV	1.2	8.0
	at 531.5000MHz	μV	2.5	8.0
AM	at 25.5000MHz	μV	0.4	1.5
	at 108.5000MHz	μV	0.4	1.5
	at 127.1750MHz	μV	0.4	1.5
	at 230.0500MHz	μV	0.4	1.5
	at 325.0500MHz	μV	0.4	1.5
2. Threshold Squelch (MANUAL)				
NFM	at 40.8400MHz	μV	0.3	0.9
	at 162.4000MHz	μV	0.3	0.9
	at 453.2500MHz	μV	0.3	1.2
	at 765.2500MHz	μV	0.5	2.0
	at 954.9125MHz	μV	0.5	2.0
	at 1299.9125MHz	μV	0.5	2.0
WFM	at 62.4500MHz	μV	1.6	7.0
	at 195.5000MHz	μV	1.6	7.0
	at 531.5000MHz	μV	2.5	7.0
AM	at 25.5000MHz	μV	0.3	2.0
	at 108.5000MHz	μV	0.3	2.0
	at 127.1750MHz	μV	0.3	2.0
	at 230.0500MHz	μV	0.3	2.0
	at 325.0500MHz	μV	0.3	2.0

REV CODE	LOT # / RNN	DATE	REV BY	CHK BY
①	INITIAL			Panf
	LIU	CHIPS		fan
△				
△				
△				
△				
△				
△				
△				
△				
△				
△				
△				
△				
△				
△				
△				
△				
△				
△				
△				
△				
△				
△				
△				
△				
△				
△				
△				

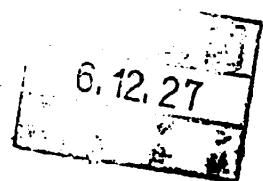

19/26

ITEM		UNIT	NOMINAL	LIMIT
3. Tight Squelch (MANUAL) (S+N)/N				
NFM	at 162.4000MHz	dB	24	15
WFM	at 62.4500MHz	dB	50	30
AM	at 127.1750MHz	dB	15	8

4. IF Rejection				
	at 40.8400MHz (IF 380.6850MHz)	dB	60	40
	at 108.5000MHz (IF 380.7000MHz)	dB	45	30
	at 162.4000MHz (IF 380.7000MHz)	dB	45	30
	at 230.0500MHz (IF 380.7000MHz)	dB	35	20
	at 453.2500MHz (IF 254.4000MHz)	dB	15	8
	at 954.9125MHz (IF 380.6875MHz)	dB	55	40

5. Acceptable Radio Frequency Displacement( EIA RS-204D)				
NFM	at 162.4000MHz	KHz	± 6	±2

6. Hum & Noise				
NFM	at 40.840 MHz	dB	40	30
	at 162.400 MHz	dB	40	30
	at 453.250 MHz	dB	36	30
	at 765.250 MHz	dB	35	25
	at 954.9125MHz	dB	35	25
	at 1299.9125MHz	dB	35	25
WFM	at 62.450 MHz	dB	50	40
	at 195.500 MHz	dB	50	40
	at 531.500 MHz	dB	50	40
AM	at 25.500 MHz	dB	45	35
	at 108.500 MHz	dB	45	35
	at 127.175 MHz	dB	45	35
	at 230.050 MHz	dB	45	35
	at 325.050 MHz	dB	45	35

7. Audio Output Power				
(at 162.400MHz NFM)				
Max.	Output Power	mW	400	180
10% THD.	Output Power	mW	300	150
(at 127.175MHz AM)				
Max.	Output Power	mW	400	180
10% THD.	Output Power	mW	300	150
(at 62.450MHz WFM)				
Max.	Output Power	mW	400	180
10% THD.	Output Power	mW	300	150

REVISIONS:				
REV CODE	LOT # /RNN	DATE	REV BY	CHK BY
0	INITIAL		/	2004
	162.4000	010325		
△				
△				
△				
△				
△				
△				
△				
△				
△				
△				
△				
△				
△				
△				

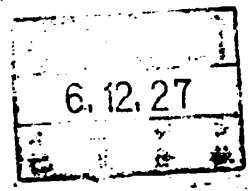

EM



20/26

ITEM		UNIT	NOMINAL	LIMIT
8. Distortion at 50mW Output Power				
at 162.400MHz	1mV Input	%	2.0	6
at 62.450MHz	1mV Input	%	1.5	5
at 127.175MHz	1mV Input	%	1.5	10
9. Audio Frequency Response -6dB				
at 162.400MHz	Low	Hz	350	250~450
	High	Hz	1800	1400~2800
at 62.450MHz	Low	Hz	220	170~320
	High	Hz	1900	1500~3000
at 127.175MHz	Low	Hz	300	250~450
	High	Hz	1800	1400~2800
10. Power Consumption (at 162.40MHz)				
(at full output)		mA DC	180	200
(at Squelched)		mA DC	70	80
(at keep alived)		mA DC	0.05	0.2
(at BATT.SAVE mode)		mA DC	15	20
11. Maximum Sensitivity (Output 50mW, Vol Max.)				
	25.500 MHz	uV	0.4	1.5
	108.500 MHz	uV	0.4	1.5
	127.175 MHz	uV	0.4	1.5
	230.050 MHz	uV	0.4	1.5
	325.050 MHz	uV	0.4	1.5
12. Residual Noise				
		mV	0.6	1.5
13. Batt.Low turn on voltage				
		V	5.5	5.2~5.8
14. Auto power off voltage				
		V	4.5	4.2~4.8
(Auto power off voltage < Batt.Low turn on voltage)				
15. Battery charge current				
		mA	50	30~70
16. Frequency stability				
		ppm	±3.5	±4.5
(-10°C~+60°C)				

REVISIONS:	REV. CODE	△	△	△	△	△	△	△	△	△	△	△	△	△	△	△	△
	DATE	9/10/92															
	LOT # / R/N	1M172A 15748															
	REVISOR																
CHECKED BY																	



6.12.27

21/26

VOLTAGE CHART

IC NO.	PIN.	CH2	CH3	CH6	CH8	CH9	CH10	CH12	CH13	CH14	CH25	REMARKS	
IC1	1	0.0	←	←	←	←	←	0.8	0.8	0.8	0.0		
	2	0.0	←	←	←	←	←	←	←	←	←		
	3	0.0	←	←	←	←	←	←	←	←	←		
	4	0.0	←	←	←	←	←	←	←	←	←		
	5	0.0	←	←	←	←	←	←	2.6	2.6	2.6	0.0	
	6	0.0	←	←	←	←	←	←	←	←	←	←	
IC2	1	0.8	0.8	0.8	0.8	0.8	0.8	0.0	0.0	0.0	0.8		
	2	0.0	←	←	←	←	←	←	←	←	←		
	3	0.0	←	←	←	←	←	←	←	←	←		
	4	2.7	2.7	2.7	2.7	2.7	2.7	2.7	0.0	0.0	0.0	2.7	
	5	0.0	←	←	←	←	←	←	←	←	←	←	
	6	2.9	2.9	2.9	2.9	2.9	2.9	2.9	0.0	0.0	0.0	2.9	
IC3	1	1.3	←	←	←	←	←	←	←	←	←		
	2	0.0	←	←	←	←	←	←	←	←	←		
	3	2.5	←	←	←	←	←	←	←	←	←		
	4	3.1	←	←	←	←	←	←	←	←	←		
	5	3.1	←	←	←	←	←	←	←	←	←		
	6	2.1	←	←	←	←	←	←	←	←	←		
IC4	1	2.4	←	←	←	←	←	←	←	←	←		
	2	0.0	←	←	←	←	←	←	←	←	←		
	3	1.2	←	←	←	←	←	←	←	←	←		
	4	3.1	←	←	←	←	←	←	←	←	←		
	5	3.1	←	←	←	←	←	←	←	←	←		
	6	1.9	←	←	←	←	←	←	←	←	←		
IC5	1	0.8	←	←	←	←	←	←	←	←	←		
	2	0.0	←	←	←	←	←	←	←	←	←		
	3	0.0	←	←	←	←	←	←	←	←	←		
	4	2.7	2.7	2.8	2.8	2.8	2.8	2.8	2.8	2.8	2.8	2.8	
	5	0.0	←	←	←	←	←	←	←	←	←	←	
	6	3.1	←	←	←	←	←	←	←	←	←	←	
IC6	1	0.0	←	←	←	←	←	←	←	←	←		
	2	3.4	←	←	←	←	←	←	←	←	←		
	3	3.4	←	←	←	←	←	←	←	←	←		
	4	1.6	←	←	←	←	←	←	←	←	←		
	5	1.6	←	←	←	←	←	←	←	←	←		
	6	1.2	1.2	1.1	1.1	1.1	1.2	1.2	1.1	1.1	1.2		
	7	1.5	←	←	←	←	←	←	←	←	←		
	8	1.3	←	←	←	←	←	←	←	←	←		
	9	3.0	←	←	←	←	←	←	←	←	←		
	10	3.1	←	←	←	←	←	←	←	←	←		
	11	0.0	←	←	←	←	←	←	←	←	←		
	12	1.6	←	←	←	←	←	←	←	←	←		
	13	1.9	←	←	←	←	←	←	←	←	←		
	14	1.3	←	←	←	←	←	←	←	←	←		
	15	0.5	←	←	←	←	←	←	←	←	←		
	16	1.3	1.3	1.3	1.4	1.4	1.4	1.4	1.4	1.4	1.4	1.4	
	17	1.5	←	←	←	←	←	←	←	←	←	←	
	18	1.5	←	←	←	←	←	←	←	←	←	←	
	19	0.0	←	←	←	←	←	←	←	←	←	←	
	20	3.1	←	←	←	←	←	←	←	←	←	←	

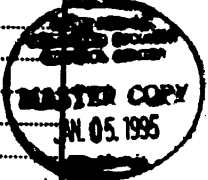

REVISIONS:	REV. CODE	△	△	△	△	△	△	△	△	△	△	△	△	△	△
	DATE	01/28/95													
	LOT # / RNN	1/11/95													
	REVISED BY														
	CHECKED BY														

6.12.27

F54-2699

VOLTAGE CHART

22/26

IC NO.	PIN.	CH2	CH3	CH6	CH8	CH9	CH10	CH12	CH13	CH14	CH25	REMARKS	
IC7	1	0.8	←	←	←	←	←	←	←	←	←		
	2	0.0	←	←	←	←	←	←	←	←	←		
	3	0.0	←	←	←	←	←	←	←	←	←		
	4	2.7	←	←	←	←	←	←	←	←	←		
	5	0.0	←	←	←	←	←	←	←	←	←		
	6	3.1	←	←	←	←	←	←	←	←	←		
IC8	1	0.0	←	←	←	←	←	←	←	←	←		
	2	0.0	←	←	←	←	←	←	←	←	←		
	3	3.4	←	←	←	←	←	←	←	←	←		
	4	3.1	0.0	←	←	←	←	←	←	←	←		
	5	0.0	3.1	0.0	0.0	0.0	0.0	0.0	0.0	0.0	0.0		
	6	0.0	0.0	3.1	0.0	0.0	0.0	0.0	0.0	0.0	0.0		
	7	0.0	0.0	0.0	3.1	0.0	0.0	0.0	0.0	0.0	0.0		
	8	0.0	←	←	←	←	←	←	←	←	←		
	9	0.0	0.0	0.0	0.0	0.0	0.0	0.0	3.1	3.1	3.1	0.0	
	10	3.1	3.1	3.1	3.1	3.1	3.1	0.0	3.1	3.1	0.0	0.0	
	11	0.0	0.0	0.0	0.0	0.0	0.0	0.0	2.9	2.9	2.9	0.0	
	12	0.0	0.0	0.0	0.0	0.0	0.0	0.0	2.9	2.9	2.9	0.0	
	13	0.0	←	←	←	←	←	←	←	←	←	←	
	14	0.0	0.0	0.0	0.0	0.0	3.1	3.1	0.0	0.0	0.0	0.0	
	15	3.4	←	←	←	←	←	←	←	←	←	←	
	16	3.1	←	←	←	←	←	←	←	←	←	←	
IC9	1	0.0	←	←	←	←	←	←	←	←	←		
	2	0.0	0.0	0.0	0.0	0.0	0.0	3.1	3.1	3.1	0.0		
	3	3.1	3.1	3.1	3.1	3.1	0.0	3.1	3.1	0.0	0.0		
	4	3.1	3.1	3.1	3.1	3.1	0.0	3.1	3.1	0.0	0.0		
	5	0.0	0.0	0.0	0.0	0.0	0.0	3.1	0.0	0.0	3.1	3.1	
	6	2.9	2.9	2.9	2.9	0.0	0.0	0.0	2.9	2.9	2.9	2.9	
	7	0.0	0.0	0.0	0.0	2.9	2.9	2.9	0.0	0.0	0.0	0.0	
	8	0.0	←	←	←	←	←	←	←	←	←	←	
	9	0.0	←	←	←	←	←	←	←	←	←	←	
	10	3.1	3.1	0.0	0.0	0.0	0.0	0.0	0.0	0.0	0.0	0.0	
	11	3.1/0	←	←	←	←	←	←	←	←	←	←	
	12	0.0	0.0	0.0	3.1	3.1	0.0	0.0	0.0	0.0	0.0	3.1	ATT. ON/OFF
	13	2.9	2.9	2.9	2.9	2.9	2.9	2.9	0.0	0.0	0.0	2.9	
	14	2.9	2.9	2.9	2.9	2.9	2.9	2.9	0.0	0.0	0.0	2.9	
	15	3.4	←	←	←	←	←	←	←	←	←	←	
	16	3.1	←	←	←	←	←	←	←	←	←	←	
IC10	1	6.4	←	←	←	←	←	←	←	←	←		
	2	0.0	←	←	←	←	←	←	←	←	←		
	3	9.3	←	←	←	←	←	←	←	←	←		
	4	9.3	←	←	←	←	←	←	←	←	←		
	5	9.3	←	←	←	←	←	←	←	←	←		
	6	24.7	←	←	←	←	←	←	←	←	←		
	7	25.4	25.3	25.2	25.0	25.1	25.3	25.2	-25.1	25.1	25.4		
	8	6.6	6.6	6.6	6.5	6.5	6.6	6.6	6.6	6.5	6.6		

TEST CONDITION SUPPLY VOLTAGE : 6.5VDC , VOLUME : MINIMUM , SQUELCH : OPEN(CW) , NO-SIGNAL  
 CH 2: 40.8400MHz (AM) CH 3: 62.4500MHz (WFM) CH 6: 162.4000MHz (NFM)  
 CH 8: 230.0500MHz (AM) CH 9: 325.0500MHz (AM) CH10: 453.2500MHz (NFM)  
 CH12: 765.2500MHz (NFM) CH13: 954.9125MHz (NFM) CH14: 1229.9125MHz (NFM)  
 CH25: 249.7000MHz (AM)



6.12.27

REVISIONS:	REV. CODE	△	△	△	△	△	△	△	△	△	△	△	△	△
	DATE	01/29/95												
	LOT #/RNN	1/117/1A												
	REVISED BY													
	CHECKED BY													

E54-2609

VOLTAGE CHART

23/26

Tr NO.		CH2	CH3	CH6	CH8	CH9	CH10	CH12	CH13	CH14	CH25	REMARKS
Q1	B	3.1	3.1	3.1	3.1	3.1	0.0	3.1	3.1	0.0	0.0	
	C	0.02	0.02	0.02	0.02	0.02	1.0	0.02	0.02	1.0	1.2	
	E	0.0	←	←	←	←	←	←	←	←	←	
Q2	B	0.0	0.0	0.0	0.0	0.0	3.1	0.0	0.0	3.1	3.1	
	C	1.5	1.5	1.5	1.5	1.5	0.03	1.5	1.5	0.03	←	
	E	0.0	←	←	←	←	←	←	←	←	←	
Q3	B	1.4	←	←	←	←	←	←	←	←	←	
	C	2.9	2.9	2.9	2.9	2.9	2.8	2.9	2.9	2.8	2.8	
	E	0.7	0.7	0.7	0.7	0.7	1.5	0.7	0.7	1.5	1.5	
Q4	B	1.9	1.9	1.9	1.9	1.9	1.7	1.9	1.9	1.7	1.7	
	C	2.9	2.9	2.9	2.9	2.9	2.8	2.9	2.9	2.8	2.8	
	E	1.4	1.4	1.4	1.4	1.4	0.9	1.4	1.4	0.9	0.9	
Q5	B	0.6	←	←	←	←	←	←	←	←	←	
	C	2.8	4.5	10.3	13.7	12.1	6.1	8.7	12.0	13.8	2.6	
	E	0.0	←	←	←	←	←	←	←	←	←	
Q6	G	1.2	1.2	1.2	1.1	1.2	1.2	1.2	1.2	1.1	1.2	
	S	1.4	←	←	←	←	←	←	←	←	←	
	D	3.1	←	←	←	←	←	←	←	←	←	
Q7	B	1.2	←	←	←	←	←	←	←	←	←	
	C	2.2	←	←	←	←	←	←	←	←	←	
	E	0.5	←	←	←	←	←	←	←	←	←	
Q8	G	1.4	1.4	1.4	1.4	1.5	1.5	1.5	1.4	1.4	1.4	
	S	1.6	1.6	1.6	1.6	1.7	1.7	1.7	1.6	1.6	1.6	
	D	3.1	←	←	←	←	←	←	←	←	←	
Q9	B	0.6	0.6	0.6	0.6	0.7	0.7	0.7	0.6	0.6	0.6	
	C	2.4	2.4	2.4	2.4	1.0	1.0	1.0	2.4	2.4	2.4	
	E	0.0	←	←	←	←	←	←	←	←	←	

TEST CONDITION SUPPLY VOLTAGE : 6.5VDC , VOLUME : MINIMUM , SQUELCH : OPEN(CW) , NO-SIGNAL  
 CH 2: 40.8400MHz (AM) CH 3: 62.4500MHz (WFM) CH 6: 162.4000MHz (NFM)  
 CH 8: 230.0500MHz (AM) CH 9: 325.0500MHz (AM) CH10: 453.2500MHz (NFM)  
 CH12: 765.2500MHz (NFM) CH13: 954.9125MHz (NFM) CH14: 1229.9125MHz (NFM)  
 CH25: 249.7000MHz (AM)

(TOP VIEW)



Q1~Q9

REVISIONS :	REV. CODE	△	△	△	△	△	△	△	△	△	△	△	△	△	△
	DATE	910321													
	LOT # / RNN	INITIAL													
	REVISED BY														
	CHECKED BY														

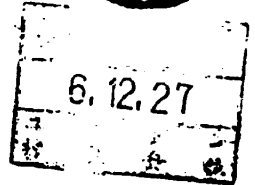
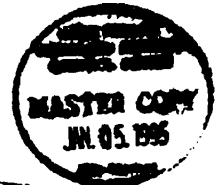

E5



VOLTAGE CHART

25/26

Tr NO.		NFM(CH6)	AM(CH5)	WFM(CH3)	REMARKS
Q201	B	0.0	4.0	0.0	※1
	C	0.0	←	←	
	E	0.0	4.0	0.0	
Q202	B	0.1	0.1	0.0	※1
	C	0.0	4.0	0.0	
	E	0.0	←	←	
Q203	B	0.0	4.0	0.0	※1
	C	0.7	0.0	0.0	
	E	0.0	←	←	
Q204	B	0.0	4.0	0.0	※1
	C	1.5	0.0	0.3	
	E	0.0	←	←	
Q205	B	1.9	1.9	0.0	※1
	C	4.0	←	←	
	E	1.3	←	←	
Q206	B	0.0	0.0	1.9	※1
	C	4.0	←	←	
	E	1.3	←	←	
Q208	B	1.9	←	←	※1
	C	4.0	←	←	
	E	1.3	←	←	
Q209	B	4.0	4.0	0.0	※1
	C	0.0	0.0	4.0	
	E	4.0	←	←	
Q210	B	0.0	0.0	3.0	※1
	C	4.0	4.0	0.0	
	E	0.0	←	←	
Q211	B	0.0	0.0	3.0	※1
	C	4.0	4.0	0.0	
	E	4.0	←	←	
Q212	B	3.0	3.0	0.0	※1
	C	0.0	0.0	3.0	
	E	0.0	←	←	
Q213	B	4.0	0.0	4.0	※1
	C	0.0	4.0	0.0	
	E	4.0	←	←	
Q214	B	0.0	3.0	0.0	※1
	C	4.0	0.0	4.0	
	E	0.0	←	←	

Tr NO.		SQ OPEN	SQ CLOSE	REMARKS
Q207	B	0.7	3.0	※1 @ CH 6 162.4000MHz
	C	1.3	0.0	
	E	1.3	←	
Q215	B	0.1	3.0	※1 @ CH 6 162.4000MHz
	C	0.3	0.0	
	E	0.0	←	

Tr NO.		BATTERY	AC ADAPTER	REMARKS
Q301	B	0	←	※1 @ CH 6 162.4000MHz
	C	3.4	←	
	E	0	←	
Q302	B	6.4	7.6	※2 @ CH 6 162.4000MHz
	C	6.4	12.0	
	E	6.4	7.0	
Q303	G	0	11.6	※3 @ CH 6 162.4000MHz
	S	6.4	12.0	
	D	6.4	7.0	

Tr NO.		LIGHT ON	LIGHT OFF	REMARKS
Q304	B	0.0	3.3	※1 @ CH 6 162.4000MHz
	C	4.9	0.0	
	E	0.0	←	

TEST CONDITION

SUPPLY VOLTAGE : 6.5VDC , VOLUME : MINIMUM  
 SQUELCH : OPEN(CW) , NO-SIGNAL  
 NFM : CH 6 162.4000MHz  
 AM : CH 5 127.1750MHz  
 WFM : CH 3 62.4500MHz

※1  
(TOP VIEW)



Q201~Q215  
Q301, Q304

※2  
(TOP VIEW)



Q302

※3  
(TOP VIEW)



Q303

REV. CODE	△	△	△	△	△	△	△	△	△	△	△	△	△	△	△
DATE	21/02/05														
LOT # / RNN	12111212														
REVISED BY															
CHECKED BY	3/2														



6.12.27

B 54-1699

VOLTAGE CHART

26/26

IC NO.	PIN.	NFM(CH6)	REMARKS	IC NO.	PIN.	NFM(CH6)	REMARKS	IC NO.	PIN.	NFM(CH6)	REMARKS
IC301	1	1.6		IC306	21	0.0		IC306	72	1.6	
	2	1.6			22	3.4			73	1.6	
	3	1.6			23	3.4			74	1.6	
	4	0.0			24	3.4			75	1.6	
	5	1.4			25	3.4			76	3.4	
	6	1.4			26	3.4			77	0.0	
	7	1.4			27	0.0			78	0.0	
	8	4.0			28	1.1			79	0.0	
IC302	1	0.0			29	2.2			80	0.0	
	2	6.4	※4		30	3.2			81	0.0	
	3	4.0			31	3.4			82	3.4	
IC303	1	3.4			32	1.6			83	3.4	
	2	3.4	※4		33	1.6			84	0.4	
	3	0.0			34	1.6			85	3.4	
IC304	1	0.0			35	1.6			86	3.3/ 0	LIGHT ON/OFF
	2	3.4			36	1.6			87	0.0	
	3	0.0			37	0.0			88	0.0	
	4	0.0			38	0.0			89	4.0	
	5	0.0			39	0.0			90	0.0	
	6	0.0			40	3.3			91	0.0	
	7	0.0		41	3.3		92	0.0			
	8	0.0		42	3.3		93	0.0			
	9	3.4		43	3.3		94	0.0			
	10	3.4		44	1.6		95	0.0			
	11	0.0		45	1.6		96	0.0			
	12	0.0		46	1.6		97	0.2			
	13	3.4		47	1.6		98	1.6			
	14	0.0		48	1.6		99	1.4			
IC305	1	0 / 11.7	BATT./AC ADAP.	49	1.6		100	2.0			
	2	3.4/7.0	BATT./AC ADAP.	50	1.6						
	3	0.0	※4	51	1.6						
IC306	1	3.3		52	1.6						
	2	0.0		53	1.6						
	3	0.0		54	1.6						
	4	0.0		55	1.6						
	5	3.3		56	1.6						
	6	0.0		57	1.6						
	7	0.5		58	1.6						
	8	0.7		59	1.6						
	9	3.4		60	1.6						
	10	3.4		61	1.6						
	11	3.4		62	1.6						
	12	3.4/ 0	SQ OPEN/CLOSE	63	1.6						
	13	0 / 3.3	SQ OPEN/CLOSE	64	1.6						
	14	0 / 3.3/ 0	CH6/CH5/CH3	65	1.6						
	15	3.3/3.3/ 0	CH6/CH5/CH3	66	1.6						
	16	0 / 0 / 3.3	CH6/CH5/CH3	67	1.6						
	17	3.3/ 0	BATT. SAVE ON/OFF	68	1.6						
	18	0.0		69	1.6						
	19	3.4		70	1.6						
	20	0.0		71	1.6						

TEST CONDITION

SUPPLY VOLTAGE : 6.5VDC  
 VOLUME : MINIMUM  
 SQUELCH: OPEN(CW) , NO-SIGNAL  
 NFM : CH 6 162.400MHz  
 AM : CH 5 127.1750MHz  
 WFM : CH 3 62.4500MHz

※4

(TOP VIEW)



IC302, IC303  
 IC305

REV. CODE	△	△	△	△	△	△	△	△	△	△	△	△	△	△	△	△
DATE	0103															
LOT #/R/N	INITIAL															
REVISED BY																
CHECKED BY	16-26															

6.12.21  
 13-1-1399





REVISIONS:				
REV CODE	LOT #	DATE	REV BY	CHK BY
0	INITIAL	11/14/94	W403S	/
△				
△				
△				
△				
△				
△				
△				
△				
△				
△				
△				
△				
△				
△				
△				
△				
△				
△				
△				
△				
△				
△				

B401 PH-153AA (BOTTOM VIEW)

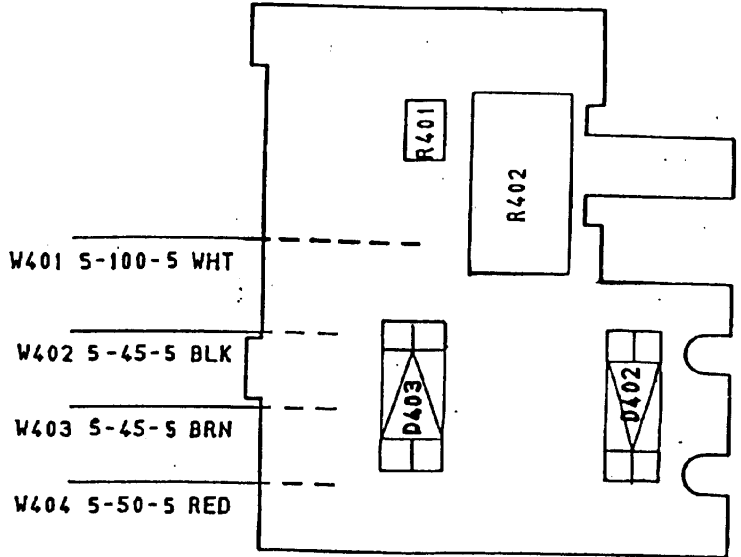

R401		1.5K
R402		150 1W
D402		DSM10C
D403		DSM10C
W401		5-100-5 WHT
W402		5-45-5 BLK
W403		5-45-5 BRN
W404		5-50-5 RED

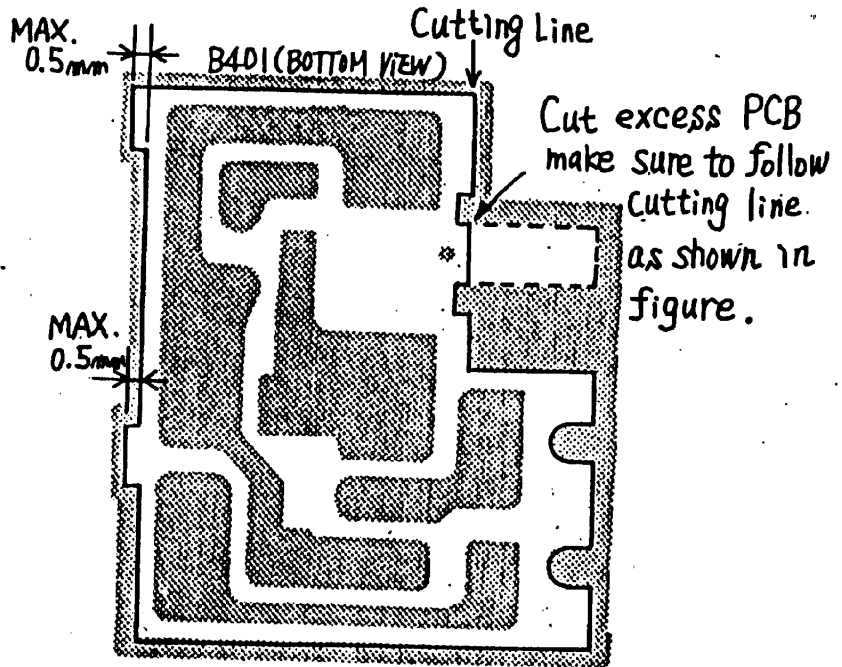
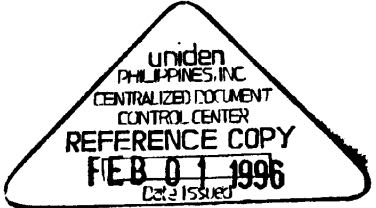

- NOTES:
- RESISTANCE VALUES ARE SHOWN IN OHMS UNLESS OTHERWISE NOTED. (K=KILO OHM, M=MEG OHM)
  - RESISTOR WATTAGES ARE 1/10W UNLESS OTHERWISE NOTED.

DESIGN. BY	DRAWN. BY	UNIDEN NO.	MODEL NO.
	94.12.22	UB-247B	UBC3000XLT
CHECK. BY	APPRO. BY	TITLE BATT. PCB PARTS ASSEMBLY BOTTOM VIEW	
'94.12.22	94.12.22	DRAWING NO. E24-11394	
REV. NO.		UNIDEN CORP.	



6.12.27

B401 PH153AA (TOP VIEW)

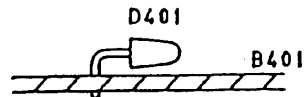
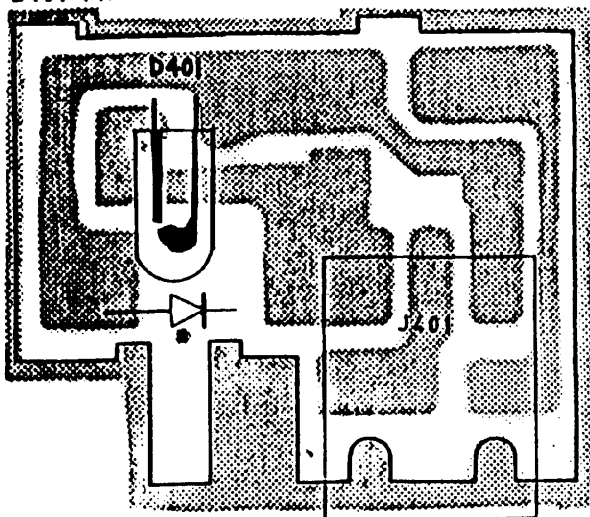

J401	JK285
D401	LLP204RS

uniden  
PHILIPPINES, INC.  
CENTRALIZED DOCUMENT  
CONTROL CENTER  
REFERENCE COPY  
1 EB 01 1998  
Date Issued

DESIGN BY	DRAWN BY	UNIDEN NO.	MODEL NO.
	94-12-22 Y. Hoshi	UB-247B	UBC3000XLT
CHECK BY	APPRO BY	TITLE BATT. PCB PARTS ASSEMBLY TOP VIEW	
94-12-22 Y. Hoshi	94.12.22 K. Yamane	DRAWING NO. E24-11393	
REV. NO.	UNIDEN CORP.		

REVISIONS:				
REV CODE	LOT # /RNN	DATE	REV BY	CHK BY
0	ISSUE	010395	/	Jung
△				
△				
△				
△				
△				
△				
△				
△				
△				
△				
△				
△				
△				
△				
△				

UNIDEN PHILIPPINES, INC.  
CENTRALIZED DOCUMENT  
CONTROL CENTER  
MASTER COPY  
JAN. 05. 1995  
REV. 010395

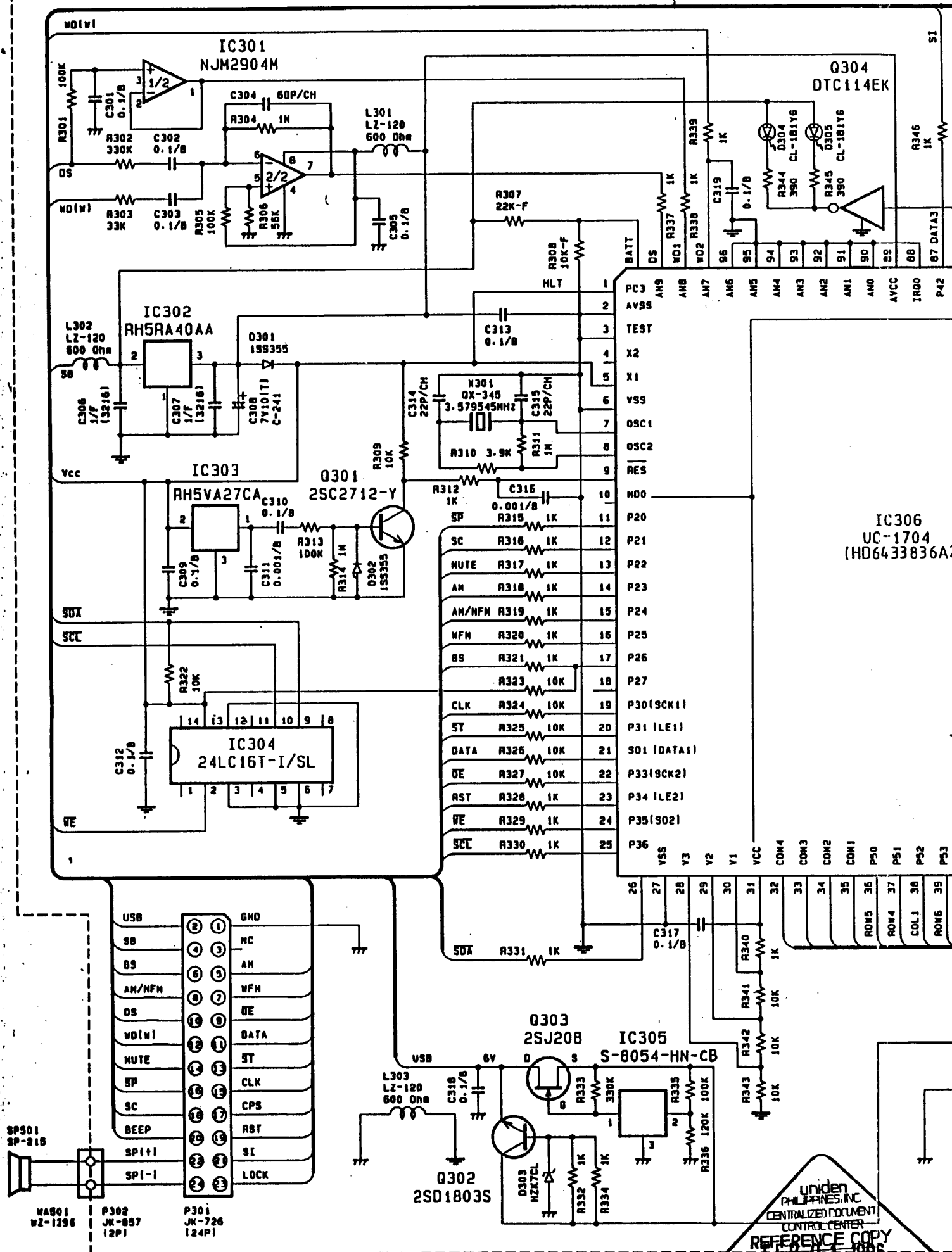

IC306  
UC-1704  
(HD6433836A2)

REV. CODE	△	△	△	△	△	△	△	△	△	△
DATE	9232C	2/11/95								
LOT # / R/RN	01/171AL	032449A								
REVISED BY										
CHECKED BY	Y. Hoshi	K. Nagai								

scn/UB247B/CP

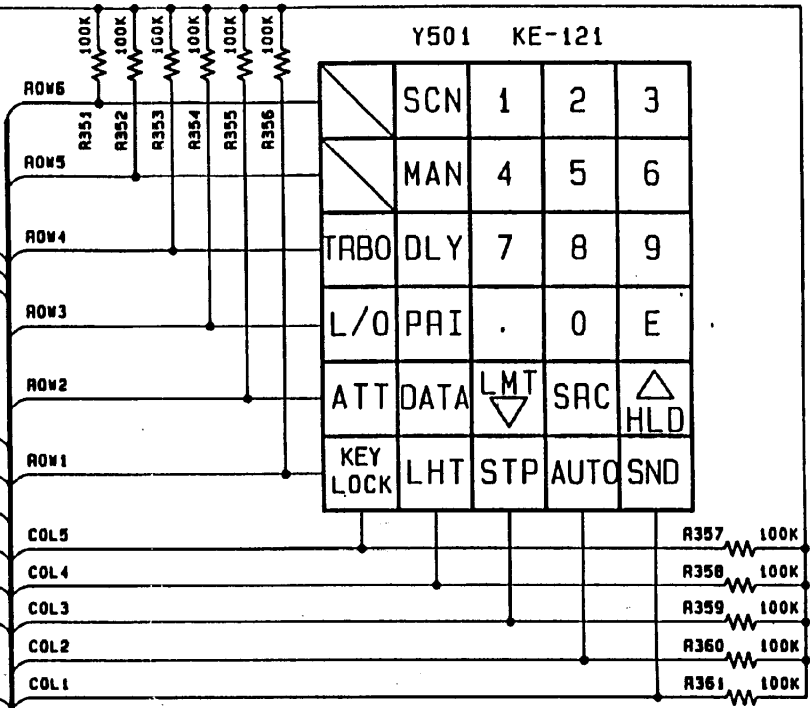
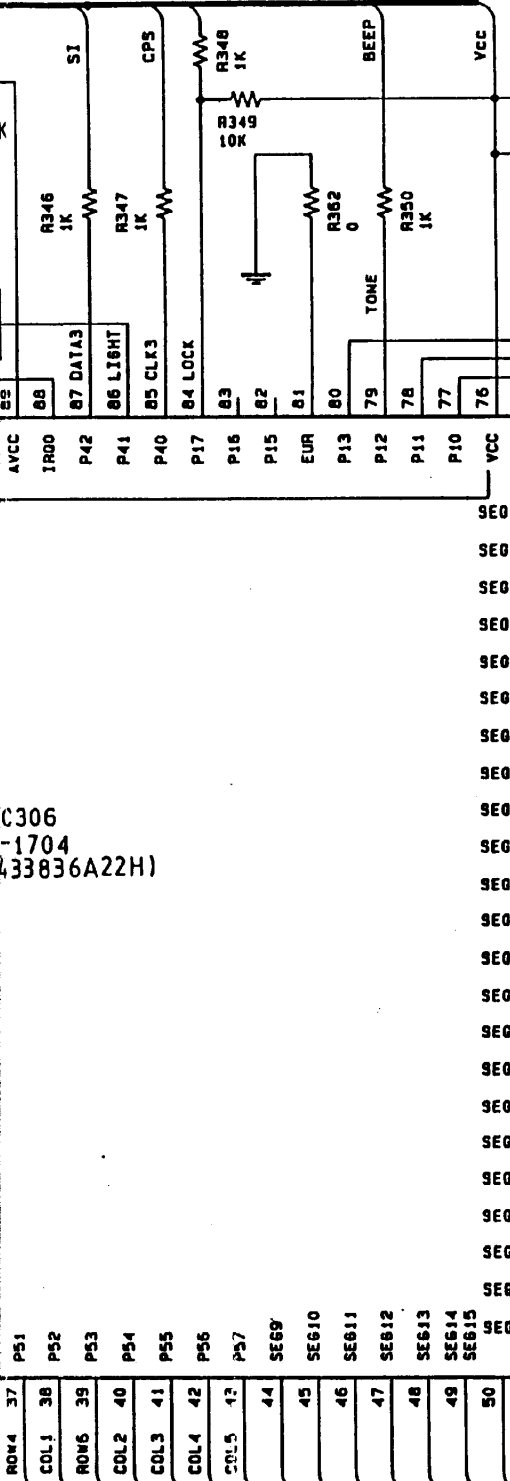

C306  
-1704  
(433836A22H)

MASTER COPY  
JAN 05 1995

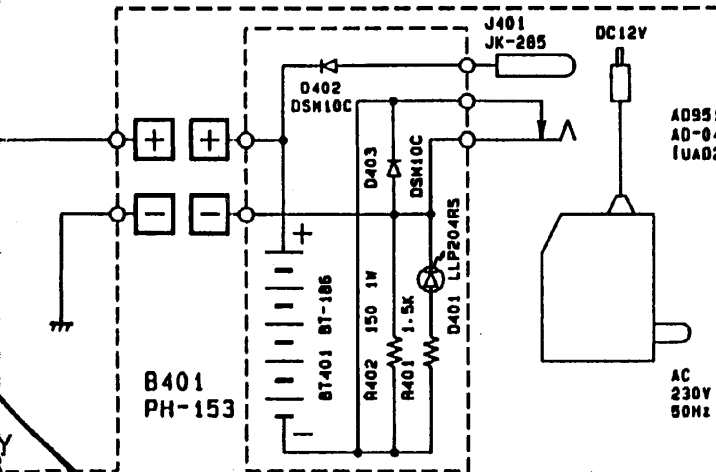
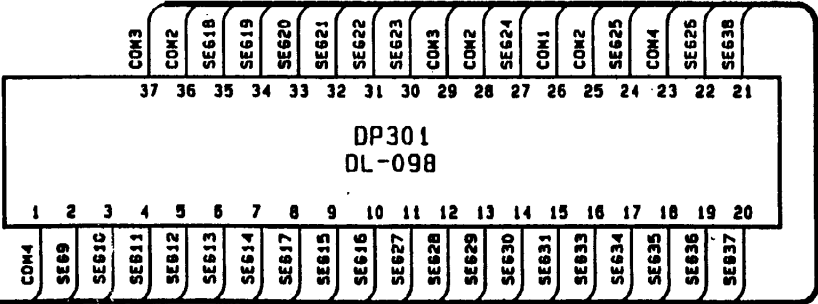

- NOTES:
1. RESISTANCE VALUES ARE SHOWN IN OHMS UNLESS OTHERWISE NOTED.
  2. RESISTOR WATTAGES ARE 1/10W UNLESS OTHERWISE NOTED.
  3. CAPACITANCE VALUES ARE INDICATED IN MICRO FARADS UNLESS OTHERWISE NOTED. (P=MICRO-MICRO FARAD)

DESIGN	94.12.6	UNIDEN NO.	UB-247B	MODEL NO.	UBC3000XLT
DRAWN BY	NAGAI	TITLE	MICOM PCB SCHEMATIC DIAGRAM		
CHECK BY	Y. HOSHI	APPRO. BY	K. Nagai	DRAWING NO.	E13-4208
REV. NO.		UNIDEN CORP.			

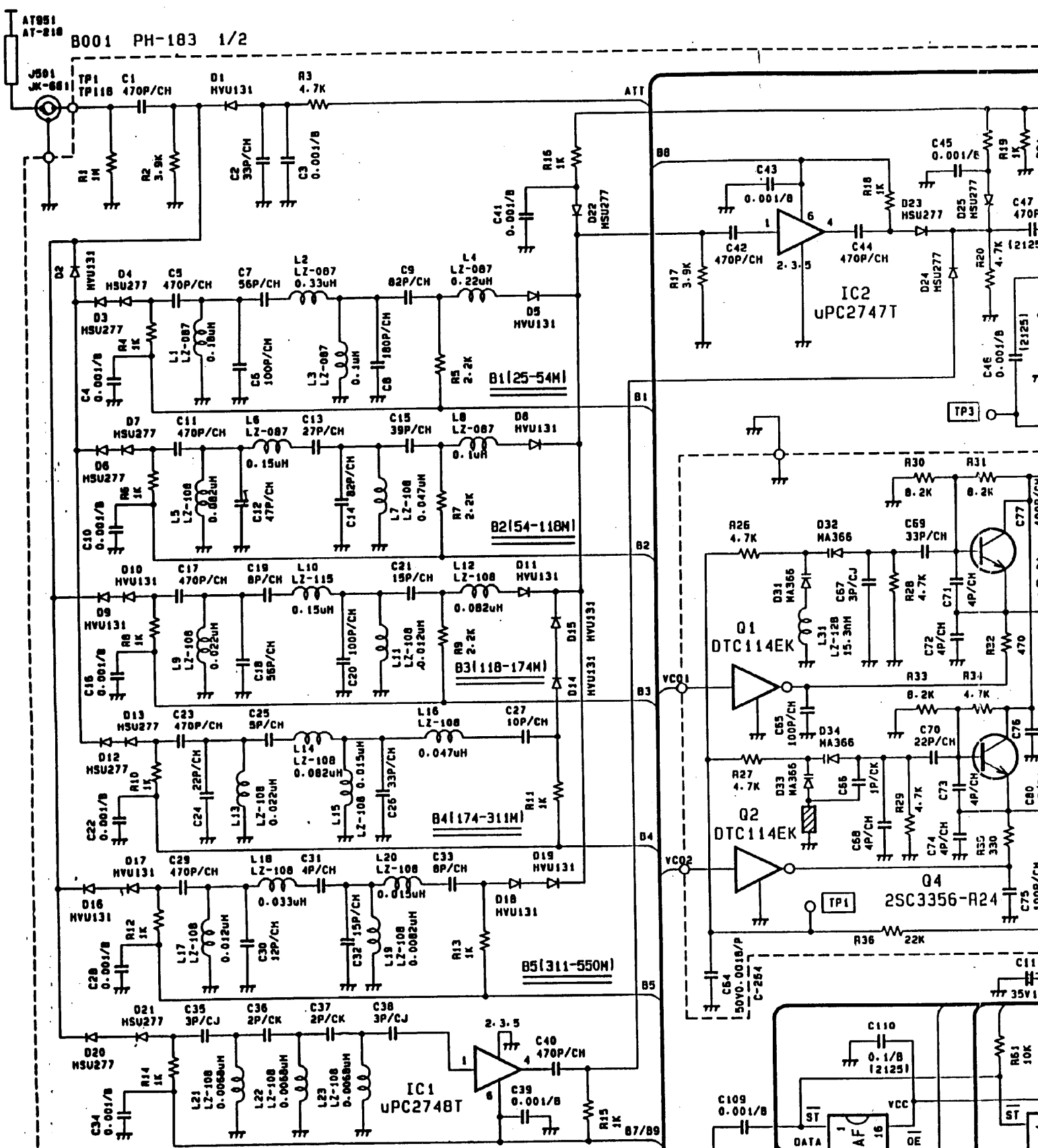

REVISIONS:

REV. CODE	DATE	LOT #/RNN	REVISED BY	CHECKED BY
△	9/10/85	INITIAL		
△				
△				
△				
△				
△				

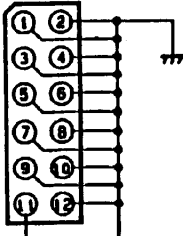

under  
PHILIPPINES, INC.  
CENTRALIZED DOCUMENT  
CONTROL CENTER  
REFERENCE COPY  
FEB 01 1996

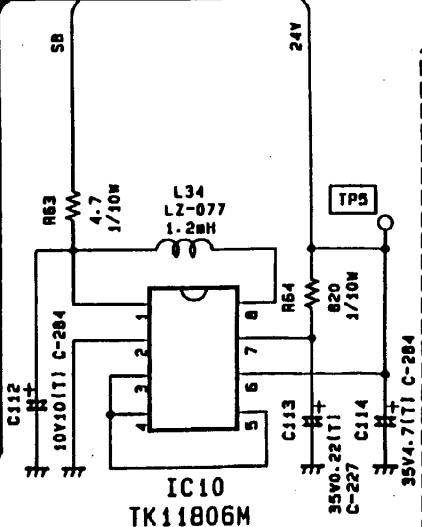
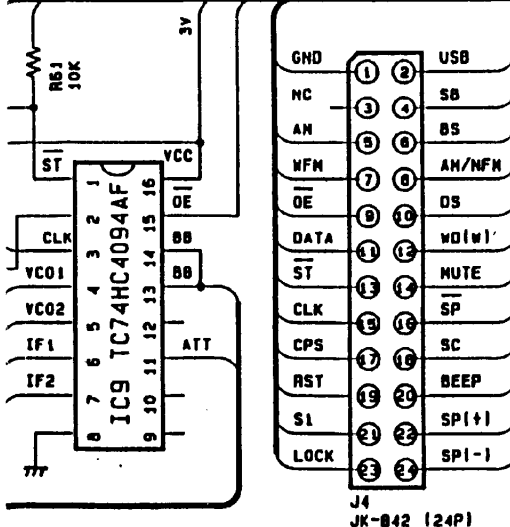
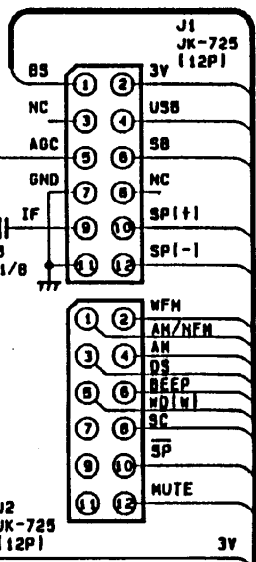
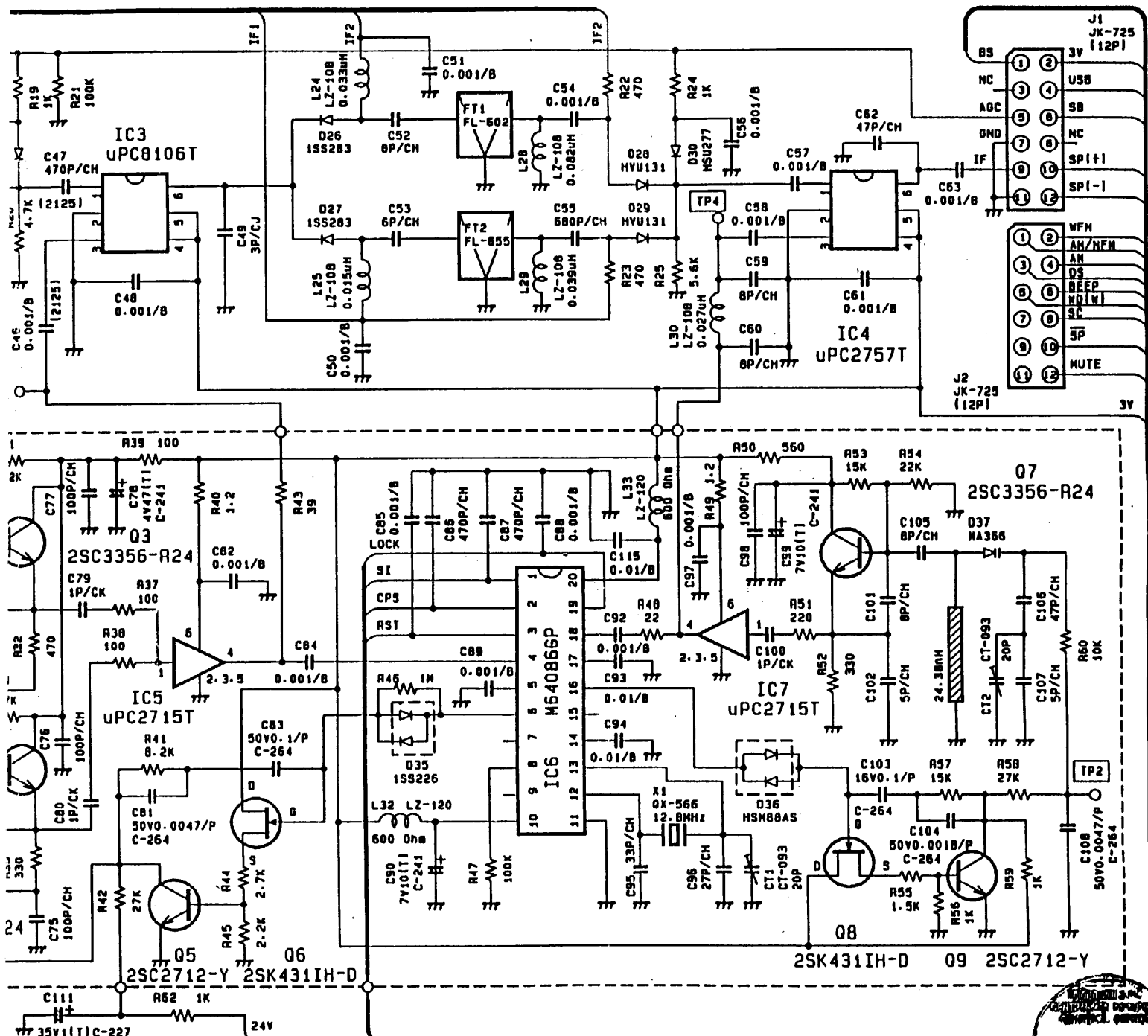

NOTES:

1. RESISTANCE VALUES ARE SHOWN IN OHMS, UNLESS OTHERWISE NOTED.
2. RESISTOR WATTAGES ARE 1/16W, 1/10W, 1/8W, 1/4W, 1/2W, 1W, 2W, 5W, 10W, 20W, 50W, 100W, UNLESS OTHERWISE NOTED.
3. CAPACITANCE VALUES ARE INDICATED IN MICRO FARADS UNLESS OTHERWISE NOTED. (P=MICRO-MICRO FARAD)

DESIGN	DRAWN BY	UNIDEN NO.	MODEL NO.
94.12.6	94.12.6	UB-247B	UBC3000XLT
HOSHI	NAGAI	TITLE RF PCB SCHEMATIC DIAGRAM	
CHECK BY	APPRO BY	DRAWING NO.	
94.12.22	94.12.22	E13-4209	
REV. NO.	UNIDEN CORP.		



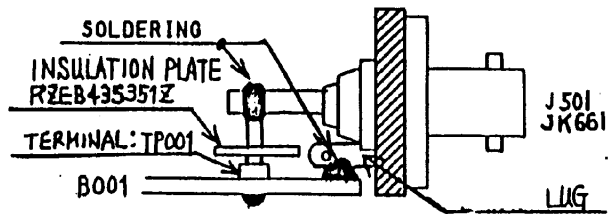

HOLDER SPEAKER  
 HHDS428717Z

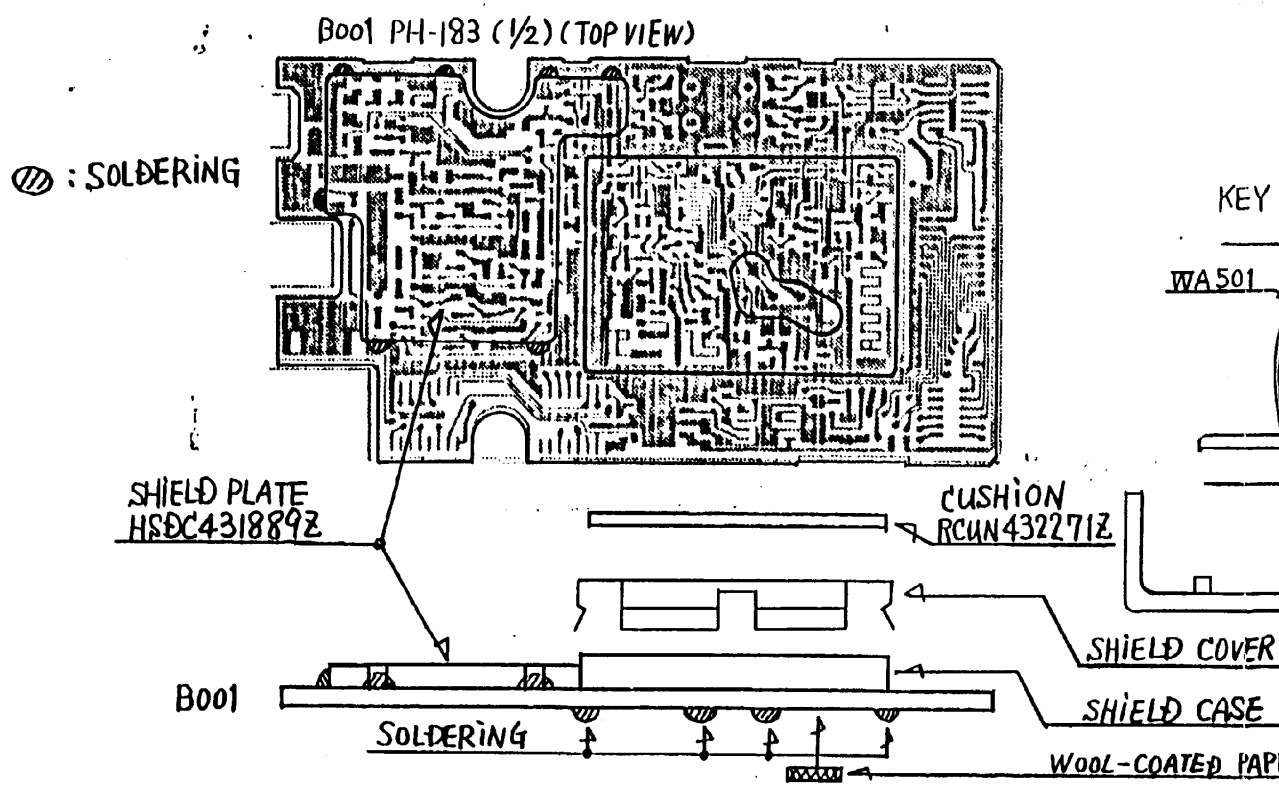
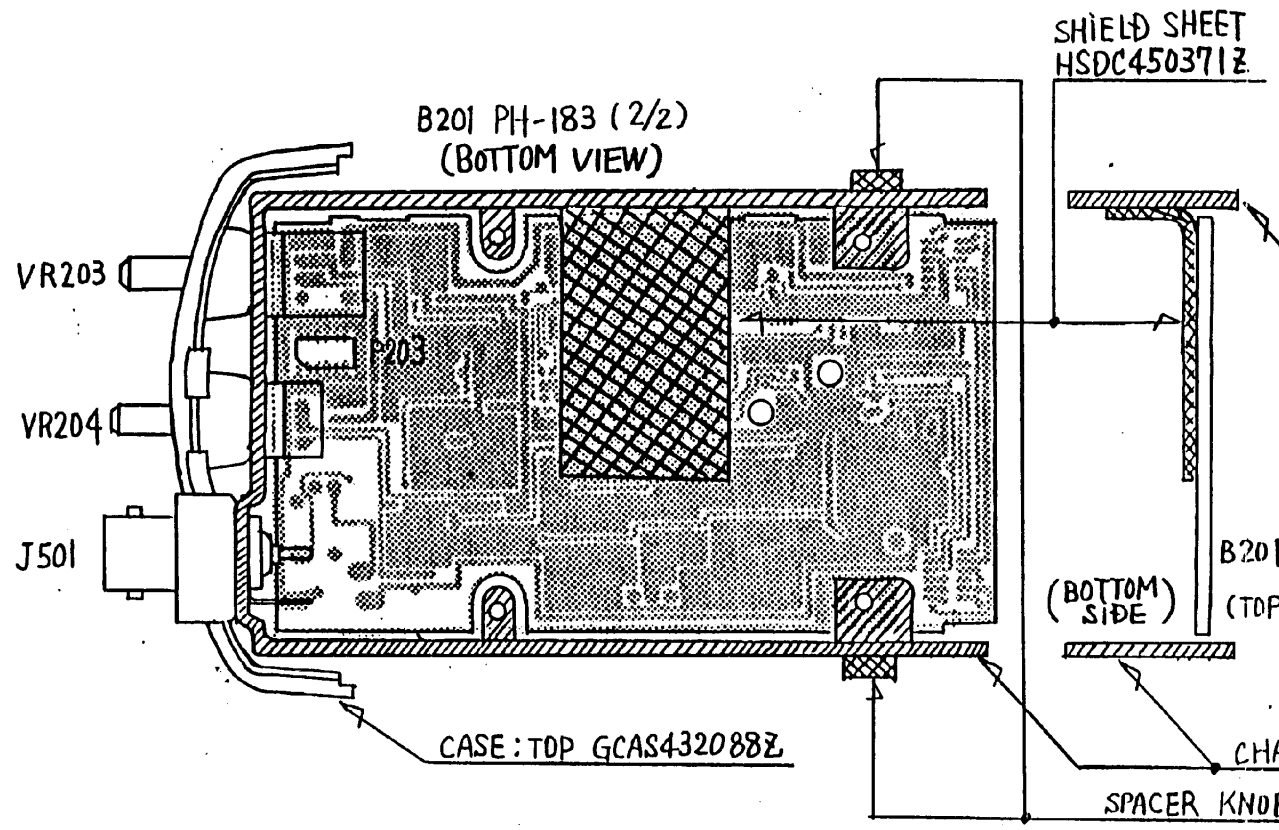

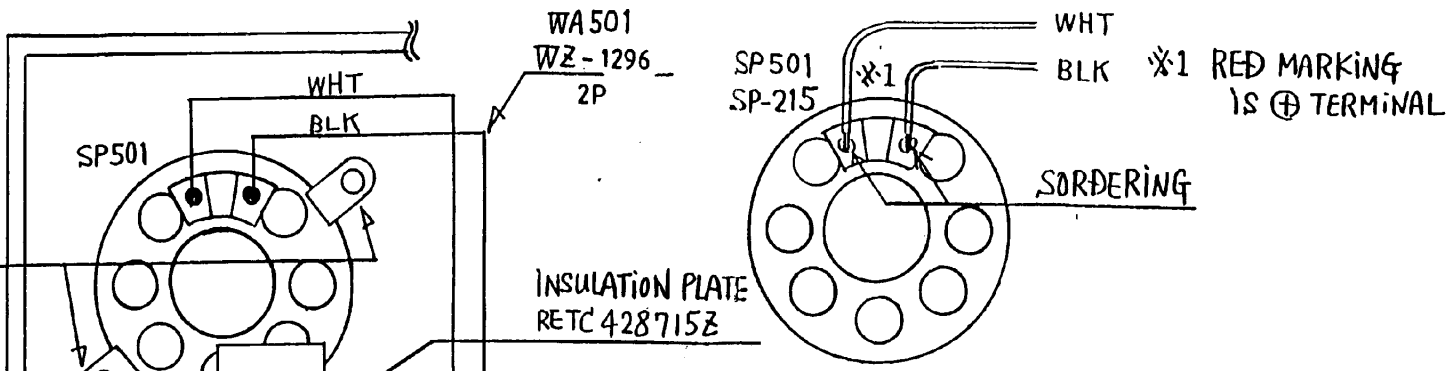

INSULATION PLATE  
RETG 428715Z

B301 PH-152 (TOP VIEW)

BATTERY SPRING  
HPSP428710Z

SOLDERING

REVISIONS:				
REV CODE	LOT # / RNN	DATE	REV BY	CH B
0	INITIAL			
1	FD 98-006	98-06-25		2
2	FD 98-011	98-07-27		2

HASSIS HCSY328709Z  
NOB LETC493827Z

Uniden  
PHILIPPINES, INC.  
CENTRALIZED DOCUMENT  
CONTROL CENTER  
REFERENCE COPY  
FEB 01 1998  
Date Issued

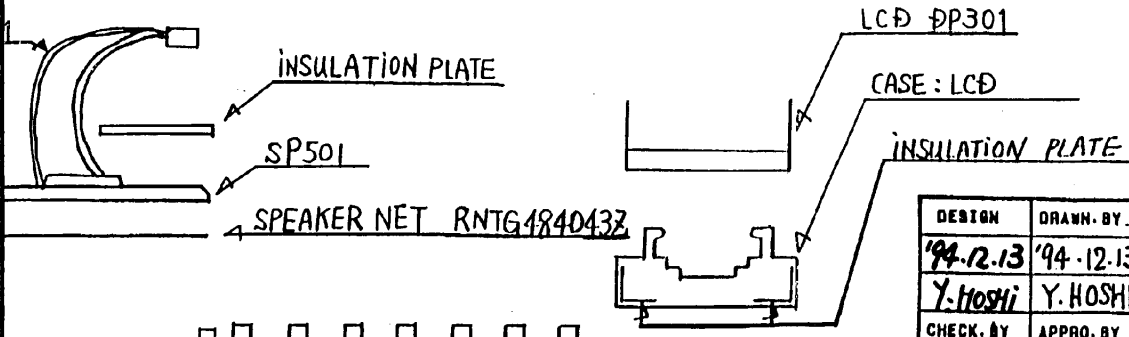
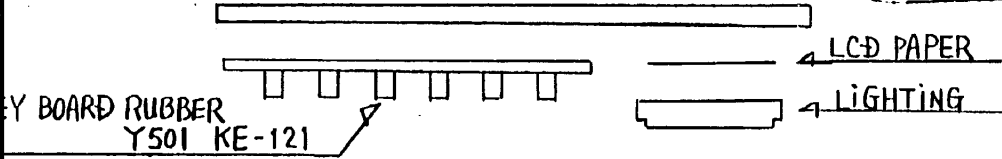

UNIDEN PHILIPPINES, INC.  
CENTRALIZED DOCUMENT CONTROL CENTER  
MASTER COPY  
AN 05 135  
ONE ORIGINAL

ER HSDC331887Z  
E HSDC331886Z  
PAPER: WOOL TACK

CASE: FRONT GCAS350475Z

DESIGN	DRAWN BY	UNIDEN NO.	MODEL NO.
'94-12-13	'94-12-13	UB-247B	UBC3000XLT
Y.HOSHI	Y.HOSHI	TITLE	
CHECK BY		APPRO. BY	
		TITLE	
		DRAWING NO.	
		E 33 - 36 02	
REV. NO.		UNIDEN CORP.	

6.12.27





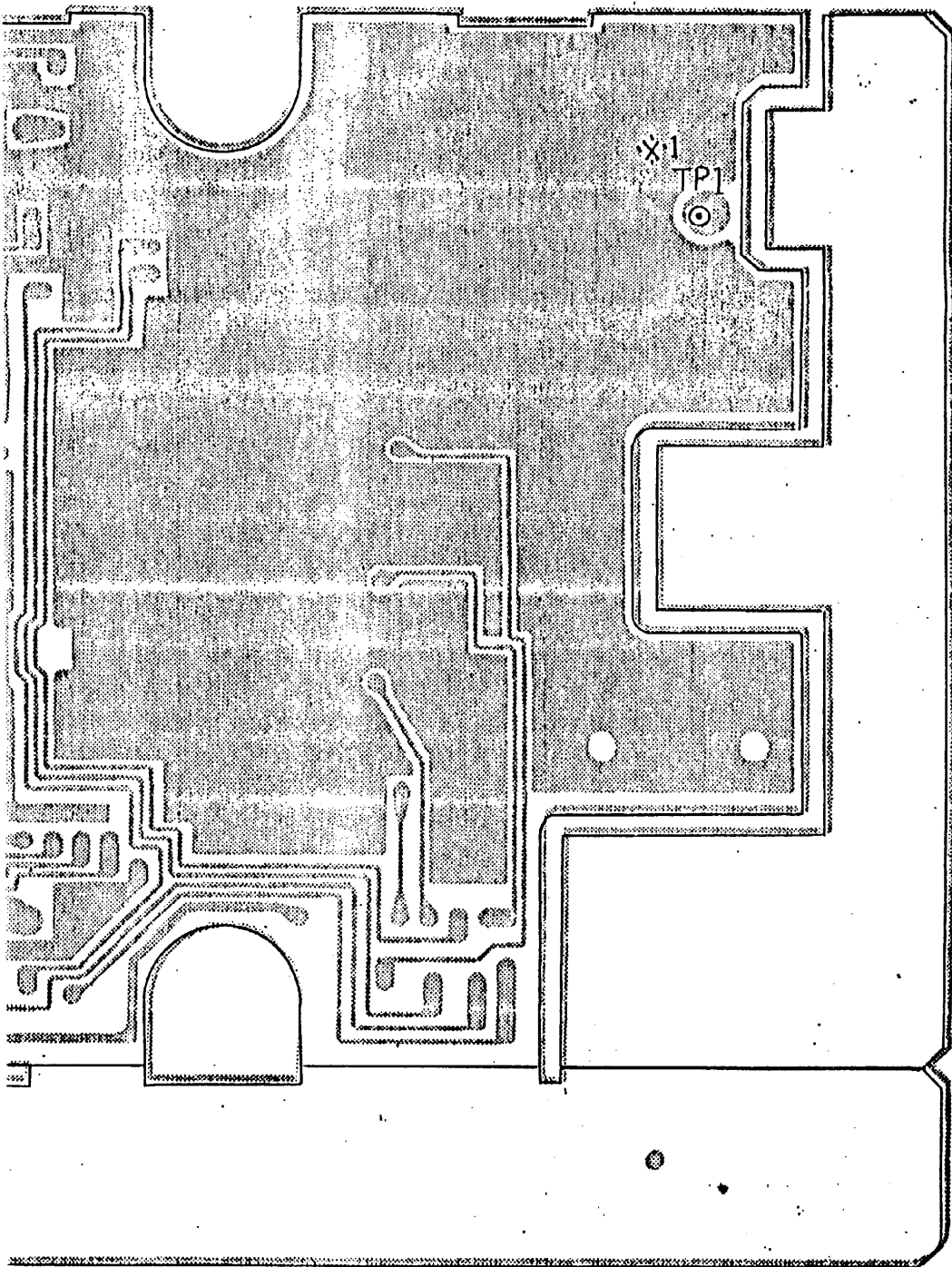

\*1 TP1

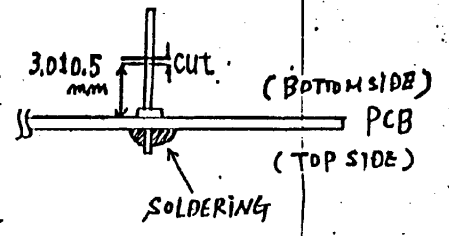

J004	JK-842 (24P)
TP001	TP-118

\*2

STICK A WOOL TACK ON PCB.

(WOOL TACK: RUTC432272Z)

UNIDEN  
 PH. JAMES, INC.  
 CENTRALIZED DOCUMENT  
 CENTRAL CENTER  
 REFERENCE COPY  
 FEB 11 1996  
 24 153 61

DESIGN BY	DRAWN BY	UNIDEN NO.	MODEL NO.
	1/4.12.20	UB-247B	UBC3000XLT
CHECK BY	APPROV. BY	TITLE R.F. PCB.	
	Y. HOSHI	PARTS ASSEMBLY BOTTOM VIEW	
04.12.22	04.12.22	DRAWING NO.	
ABE	K. Hoshino	E22-11398	
REV. NO.		UNIDEN CORP.	

REFERENCE COPY  
 JK.05.105

6.12.27

B201 PH-183AA (2/2) (BOTTOM VIEW)

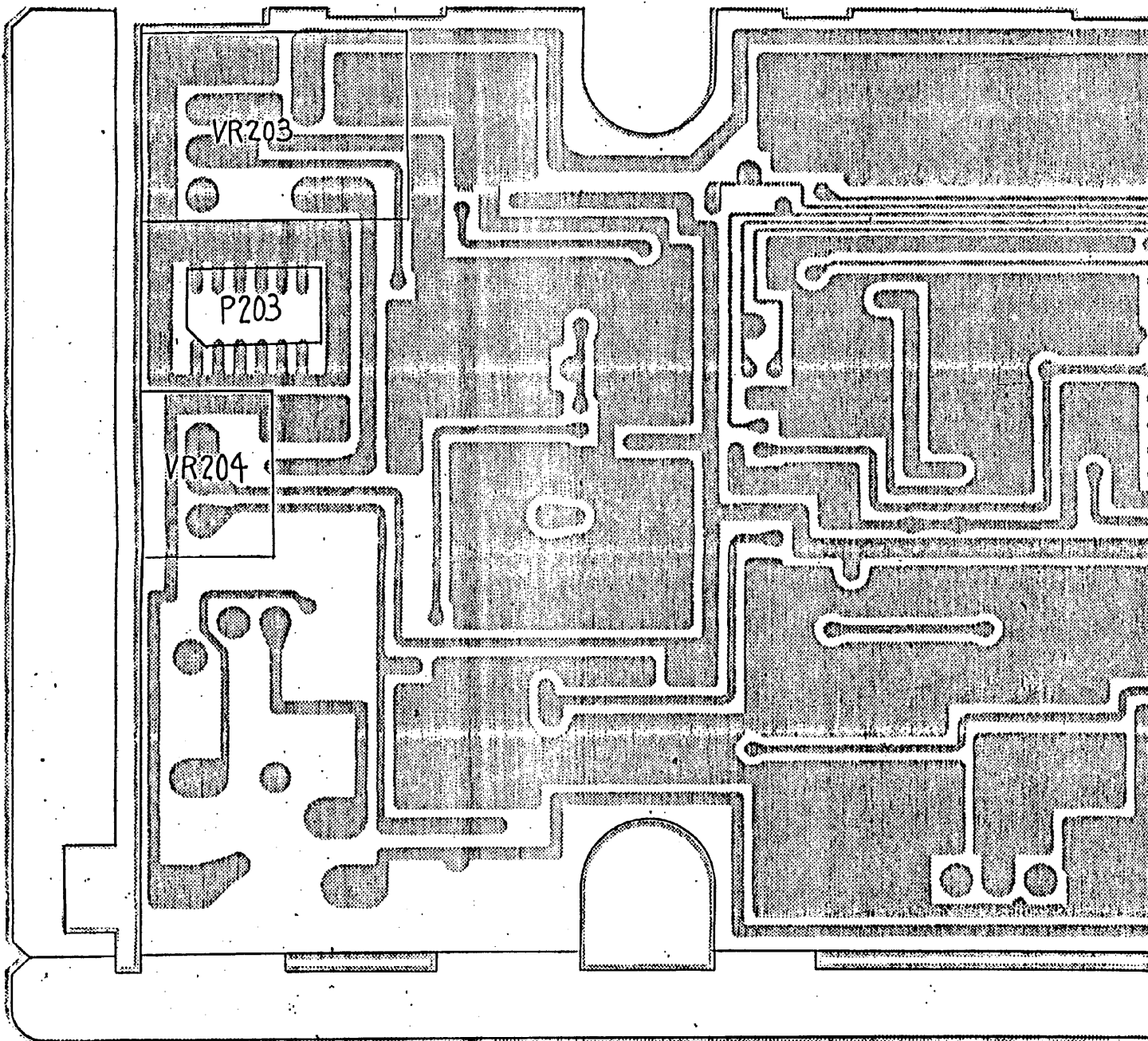

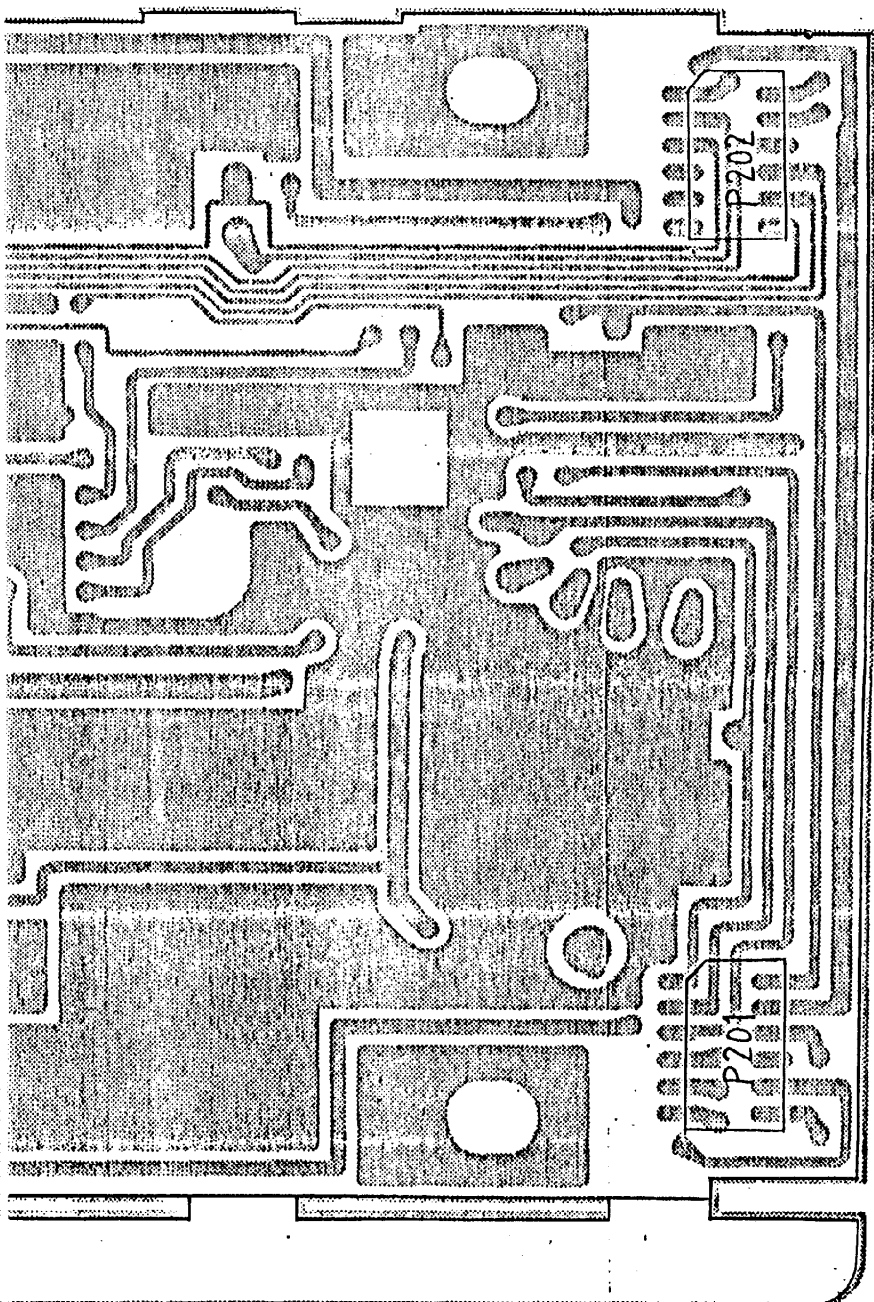

P201	JK-841 (12P)
P202	JK-841 (12P)
P203	JK-841 (12P)
VR203	RV-829 100KA
VR204	RV-830 100KA

REVISIONS:					
REV. NO.	DATE	BY	CHKD. BY	DESCRIPTION	REASON
1	04.12.22	Y.HOSHI		INITIAL	100%
2					
3					
4					
5					
6					
7					
8					
9					
10					
11					
12					
13					
14					
15					

UNIDEN  
 PHILIPPINES, INC.  
 CENTRALIZED DOCUMENT  
 CONTROL CENTER  
 REFERENCE COPY  
 FEB 01 1996  
 Doc. # 15245

DESIGN BY	Y.HOSHI	UNIDEN NO.	UB-247 B	MODEL NO.	UBC3000XLT
CHECK BY	Y.HOSHI	TITLE	IR PCB		
APPRO. BY	K.//	PARTS ASSEMBLY	BOTTOM VIEW		
REV. NO.		DRAWING NO.	E22-11400		
			UNIDEN CORP.		

MASTER COPY  
 JK 01 1995

6.12.27  
 19 25 27 29



B201 PH-183AA (3/2) (TOP VIEW)

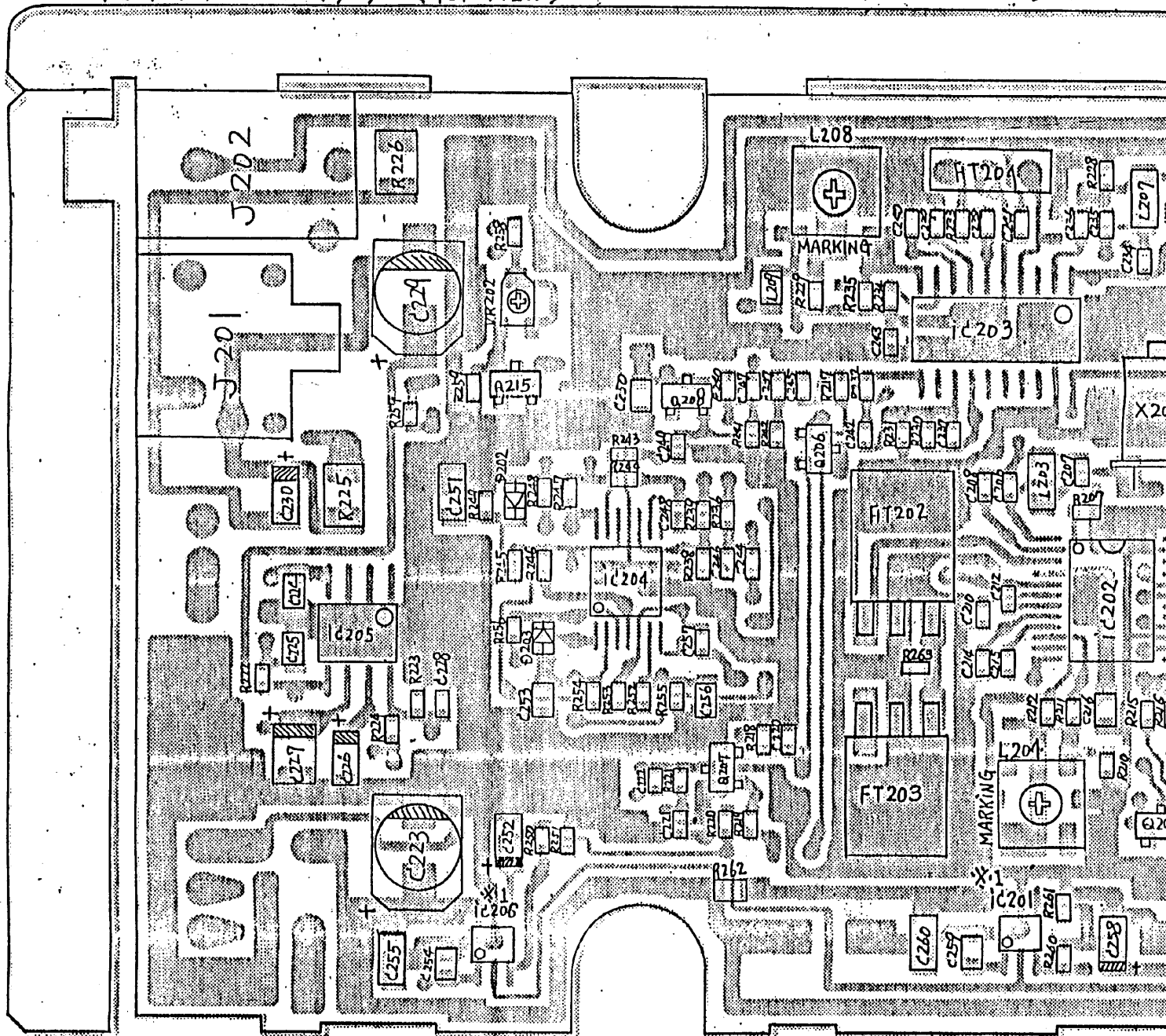

IC201	TK11000M
IC202	TK10400V
IC203	TK10400M
IC204	NJM3403AV
IC205	TDA7233D
IC206	TK11900M
Q201	2SA1162-Y
Q202	2SC2712-Y
Q203	DTC114EK
Q204	DTC114FK
Q205	2SC2712-Y
Q206	2SC2712-Y
Q207	2SA1162-Y
Q208	2SC2712-Y
Q209	DTA114YK
Q210	DTC114EK
Q211	DTA114YK
Q212	DTC114EK
Q213	DTA114YK
Q214	DTC114EK

Q215	DTC114EK
D201	DAN235K
D202	ISS355
D203	ISS355
L201	LC-246
L202	LZ-087 2.2UH
L203	LZ-087 0.47UH
L204	LF-235
L205	LZ-120 600Ω
L206	LC-247
L207	LZ-087 0.1UH
L208	LF-254
L209	LZ-120 600Ω
FT201	FL-653
FT202	FL-654
FT203	FL-654
FT204	FL-582

X201	QX-567 (57.62MI2)
X202	QX-568 (52.575MI2)
J201	JK-838
J202	JK-424
VR201	RT-550 47KD
VR202	RT-550 100KD

R201	4.7K
R202	1K
R203	1.2K
R204	47K
R205	47K
R206	3.3K
R207	4.7K
R208	47K
R209	22K
R210	47K
R211	2.2K
R212	33K
R213	56K
R214	10K
R215	27K
R216	10K
R217	10K
R218	10K
R219	47K
R220	47K
R221	680K

R222	4.7
R223	22K
R224	30K
R225	10 (1/4W)
R226	8.2 (1/4W)
R227	1K
R228	2.2K
R229	47K
R230	270K
R231	180K
R232	56K
R233	1K
R234	1.8K
R235	6.8K
R236	8.2K
R237	1.2K
R238	150K
R239	150K
R240	160K
R241	150K
R242	3.9K

R243	3.0K
R244	16K
R245	4.7K
R246	10K
R247	150K
R248	100
R249	4.7K
R250	27K-F
R251	12K-F
R252	220K
R253	680K
R254	1M
R255	2.2M
R256	330K
R257	1K
R258	1K
R259	2.7K
R260	18K-F
R261	12K-F
R262	22 (1/10W)
R263	1.5K





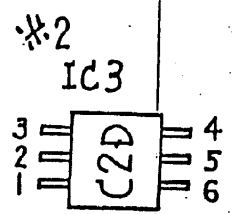
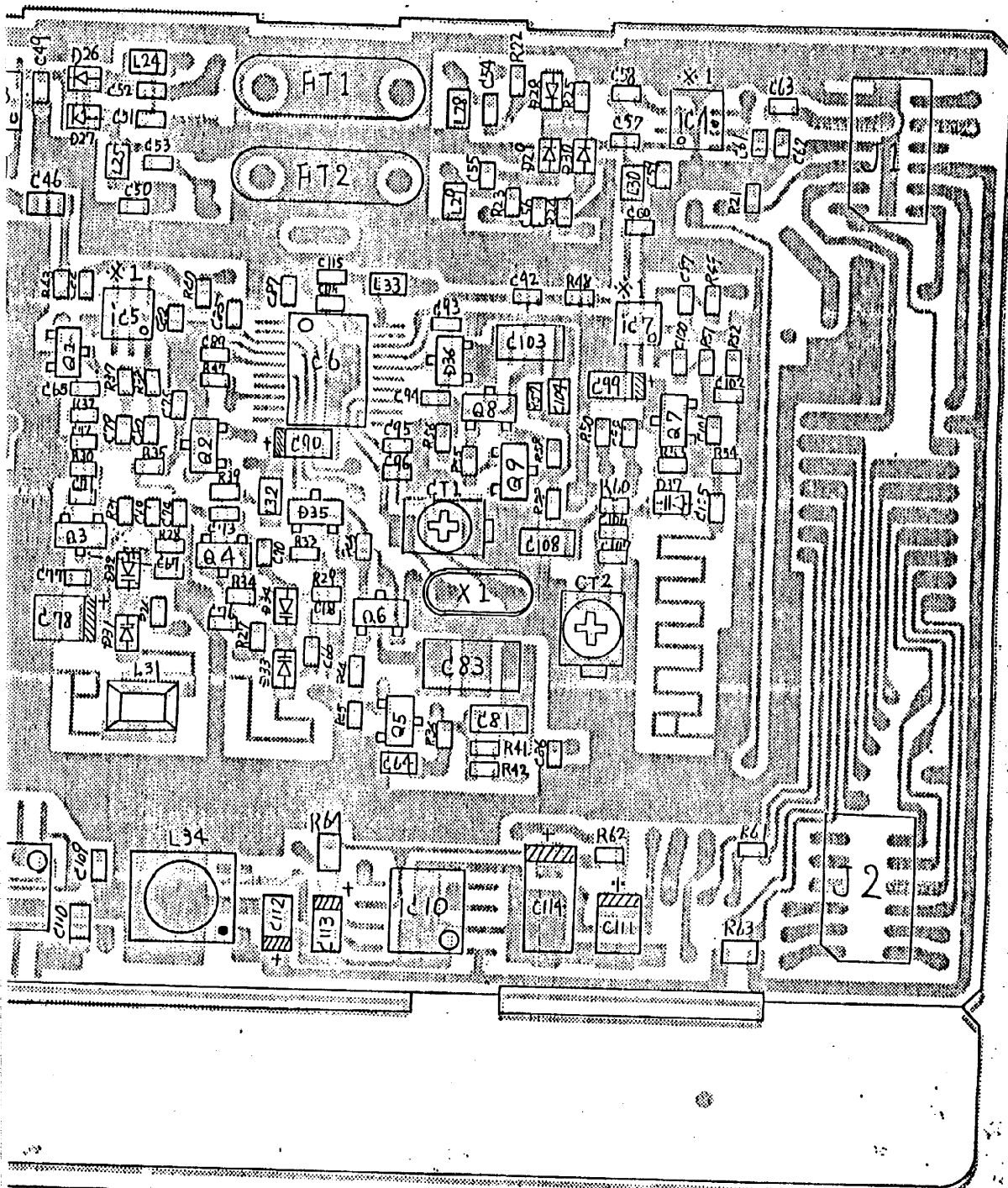

C083	0.1/P 50V C-264
C084	0.001/B
C085	0.001/B
C086	470P/CI
C087	470P/CI
C088	0.001/B
C088	0.001/B
C090	7V10(T) C-241
C092	0.001/B
C093	0.01/B
C094	0.01/B
C095	33P/CI
C098	27P/CI
C097	0.001/B
C098	100P/CI
C099	7V10(T) C-241
C100	1P/CK
C101	8P/CI
C102	5P/CI
C103	0.1/P 18V C-264
C104	0.0018/P 60V C-264
C105	8P/CI
C106	47P/CI
C107	5P/CI
C108	0.0047/P 50V C-264
C109	0.001/B
C110	0.1/B (2125)
C111	35V1(T) C-227
C112	10V10(T) C-284
C113	35V0.22(T) C-227
C114	35V4.7(T) C-284
C115	0.01/B

0	1.2	R062	1K	C010	8P/CI	C041	0.001/B	C063	0.001/B
1	R.2K	R063	4.7 (1/10W)	C020	100P/CI	C042	470P/CI	C064	0.0018/P 50V C-264
2	27K	R064	820 (1/10W)	C021	15P/CI	C043	0.001/B	C065	100P/CI
3	30			C022	0.001/B	C044	470P/CI	C066	1P/CK
4	2.7K	C001	470P/CI	C023	470P/CI	C045	0.001/B	C067	3P/CJ
5	2.2K	C002	33P/CI	C024	22P/CI	C046	0.001/B (2125)	C068	4P/CI
6	1H	C003	0.001/B	C025	5P/CI	C047	470P/CI (2125)	C069	33P/CI
7	100K	C004	0.001/B	C026	33P/CI	C048	0.001/B	C070	22P/CI
8	22	C005	470P/CI	C027	10P/CI	C049	3P/CJ	C071	4P/CI
9	1.2	C006	100P/CI	C028	0.001/B	C050	0.001/B	C072	4P/CI
0	560	C007	56P/CI	C029	470P/CI	C051	0.001/B	C073	4P/CI
1	220	C008	180P/CI	C030	12P/CI	C052	8P/CI	C074	4P/CI
2	330	C009	82P/CI	C031	4P/CI	C053	6P/CI	C075	100P/CI
3	15K	C010	0.001/B	C032	15P/CI	C054	0.001/B	C076	100P/CI
4	22K	C011	470P/CI	C033	8P/CI	C055	680P/CI	C077	100P/CI
5	1.5K	C012	47P/CI	C034	0.001/B	C056	0.001/B	C078	4V47(T) C-241
6	1K	C013	27P/CI	C035	3P/CJ	C057	0.001/B	C079	1P/CK
7	15K	C014	82P/CI	C036	2P/CK	C058	0.001/B	C080	1P/CK
8	27K	C015	30P/CI	C037	2P/CK	C059	8P/CI	C081	0.0047/P 50V C-264
9	1K	C016	0.001/B	C038	3P/CJ	C060	8P/CI	C082	0.001/B
0	10K	C017	470P/CI	C039	0.001/B	C061	0.001/B		
1	10K	C018	56P/CI	C040	470P/CI	C062	47P/CI		

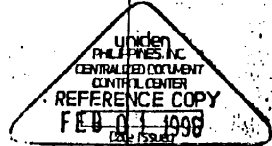

NOTES:  
 1. RESISTANCE VALUES ARE SHOWN IN OHMS UNLESS OTHERWISE NOTED. 1K-KILO OHM, M-MEG OHM  
 2. RESISTOR WATTAGES ARE 1/16W UNLESS OTHERWISE NOTED  
 3. CAPACITANCE VALUES ARE INDICATED IN MICRO FARADS UNLESS OTHERWISE NOTED. 1P-MICRO-MICRO FARAD

DESIGN BY	DRWN BY	UNIDEN NO.	MODEL NO.
	W-12-20	UB-247B	UBC9000XLT
CHECK BY	APPR BY	TITLE RF PCB	
	Y.HOSHI	PARTS ASSEMBLY TOP VIEW	
	W-12-22	DRAWING NO.	
	Y.HOSHI	E22-1139.7	
REV. NO.		UNIDEN CORP.	



6.12.27



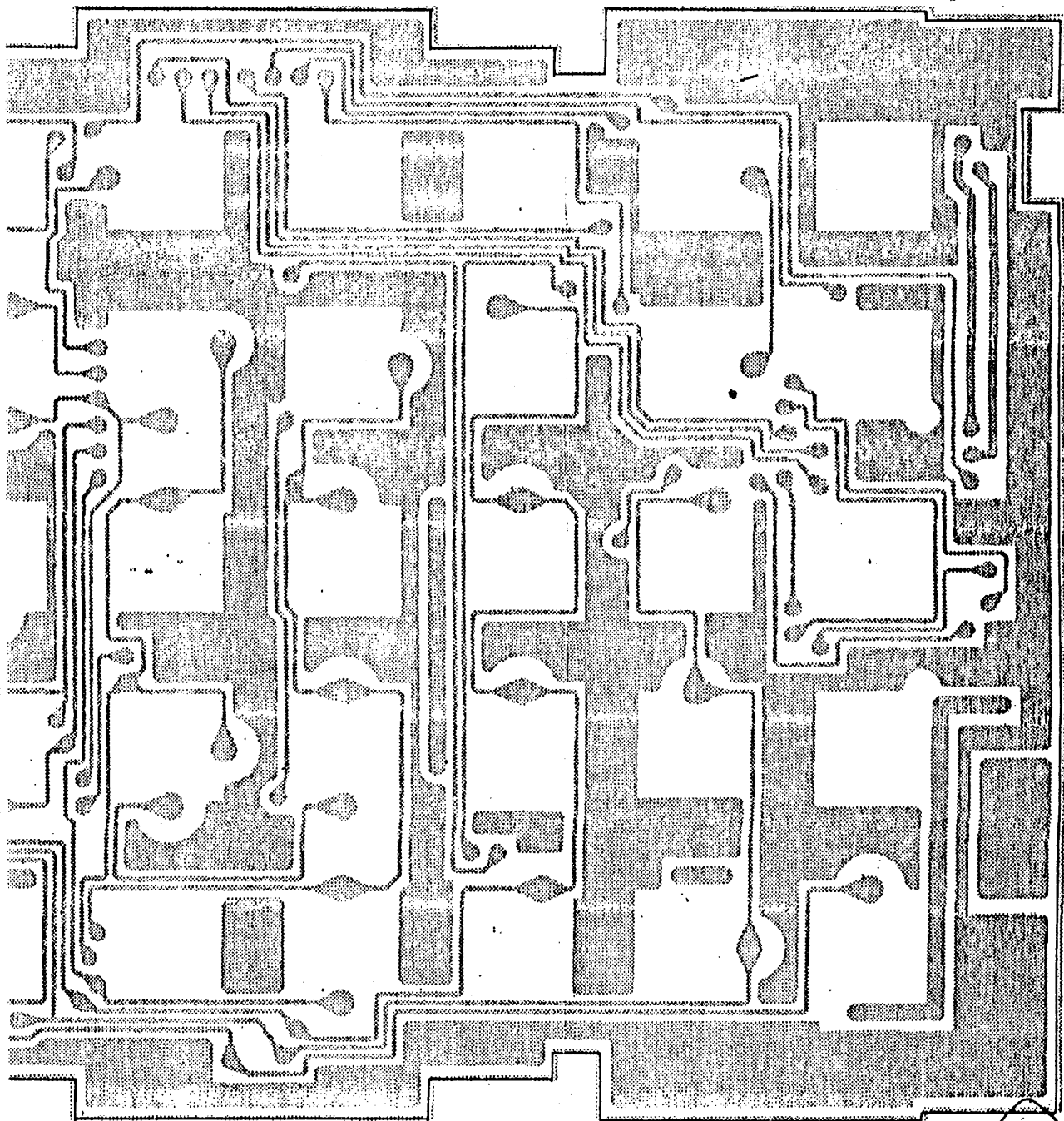

REVISIONS:				
REV	LOT #	DATE	REV	CHECK
CODE	AMN		BY	BY
△	INITIAL		/	/
△				
△				
△				
△				
△				
△				
△				
△				
△				
△				
△				
△				
△				
△				
△				
△				

Uniden  
 PALAPRES INC  
 CENTRAL DESIGN & MFG  
 CENTRAL CENTER  
 REFERENCE COPY  
 FEB 01 1996  
 02415361

MASTER COPY  
 JUN 05 1995

D304	CL-18-YG
D305	CL-18-YG
DP301	DL-018

DESIGN BY	DRAWN BY	UNIDEN NO.	MODEL NO.
	04.11.20	UB-247B	UBC3000XLT
CHECK BY	APPROV BY	TITLE	
	Y. Hoshi	MICOM PCB	
		PARTS ASSEMBLY BOTTOM VIEW	
		DRAWING NO.	
	04.12.22	E22-11396	
REV. NO.		UNIDEN CORP.	

6.12.27

ORIENTATION



# B301 PH-152 BA (BOTTOM VIEW)

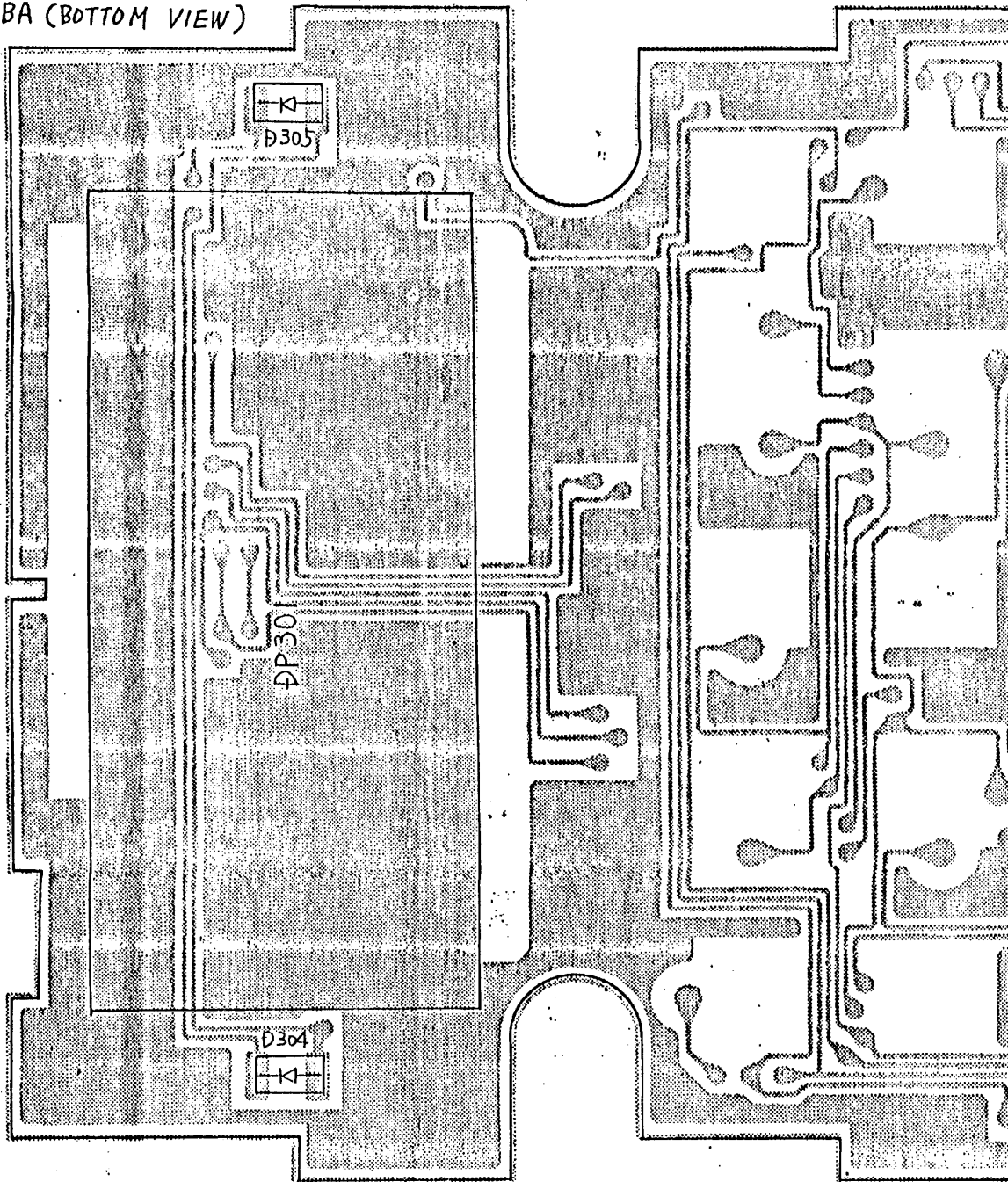

- LCR 3392378
- ATTN PLATE 450507E
- DP-301
  - \* ALL OF LEGS ARE SOLDERED AT TOP SIDE.
- ING 325746E
- PAPER 110763E
- B301
  - BOTTOM

ORIENTATION

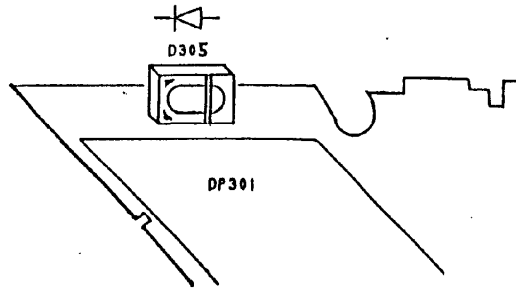

B 301 PH-152 BA (TOP VIEW)

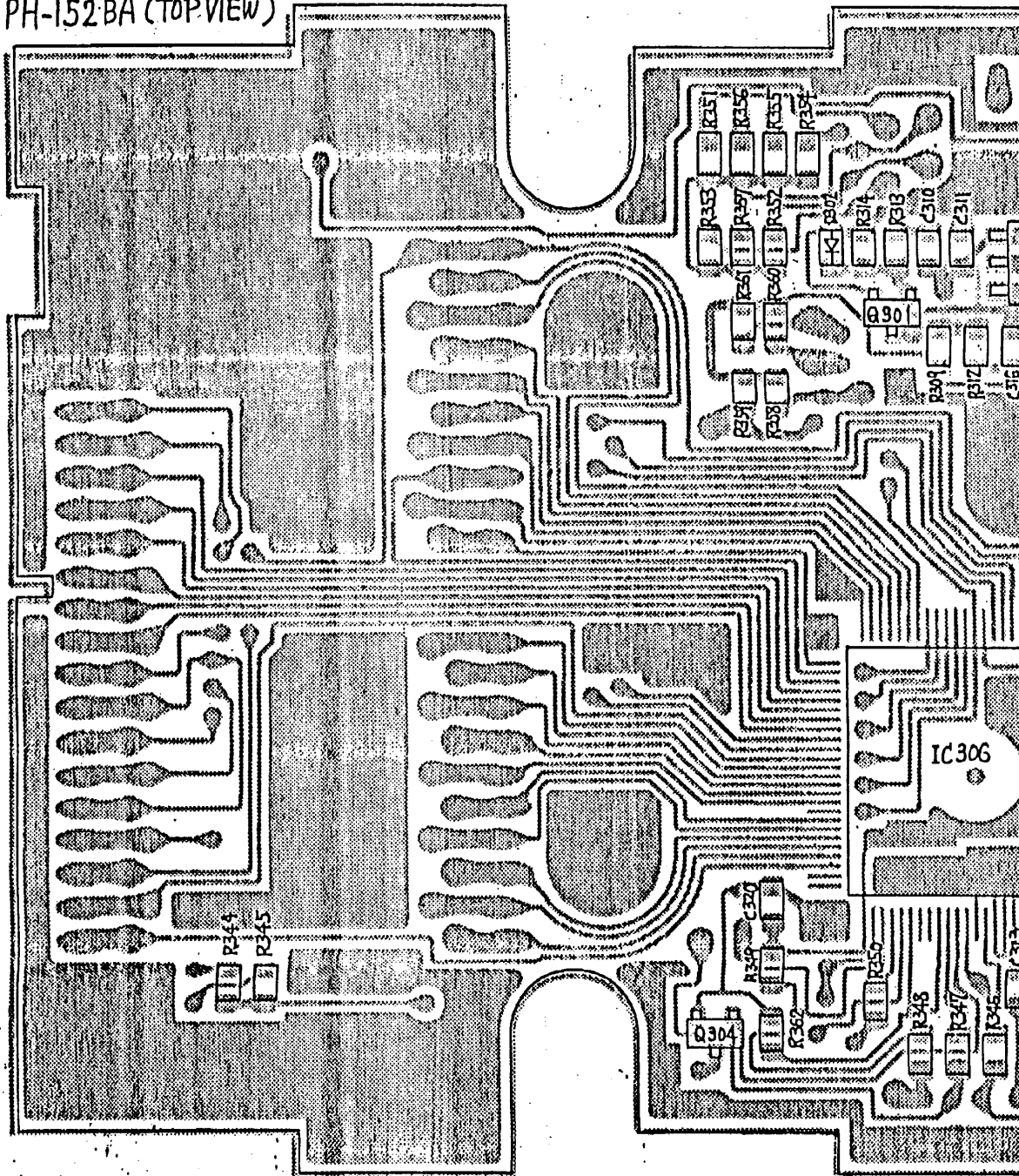

IC301	NJM2904M
IC302	RI5RA40AA
IC303	RI5VA27CA
IC304	24LC16T-1/SL
IC305	S-8054-1N-CB
IC300	IC1704 (HD6433836A22H)
Q301	2SC2712-Y
Q302	2SD1803-S
Q303	2SJ208
Q304	DTC114EK
D301	1SS355
D302	1SS355
D303	11ZK7CL
X301	QX-345 (3.570545MHz)

L301	LZ-120 600Ω
L302	LZ-120 600Ω
L303	LZ-120 600Ω
P301	JK-726 (24P)
P302	JK-857 (2P)
R301	100K
R302	330K
R303	33K
R304	1M
R305	100K
R306	56K
R307	22K-F
R308	10K-F
R309	10K
R310	3.9K
R311	1M
R312	1K
R313	100K

R314	1M
R315	1K
R316	1K
R317	1K
R318	1K
R319	1K
R320	1K
R321	1K
R322	10K
R323	10K
R324	10K
R325	10K
R326	10K
R327	10K
R328	1K
R329	1K
R330	1K
R331	1K
R332	1K
R333	330K

R334	
R335	
R336	
R337	
R338	
R339	
R340	
R341	
R342	
R343	
R344	
R345	
R346	
R347	
R348	
R349	
R350	
R351	
R352	
R353	

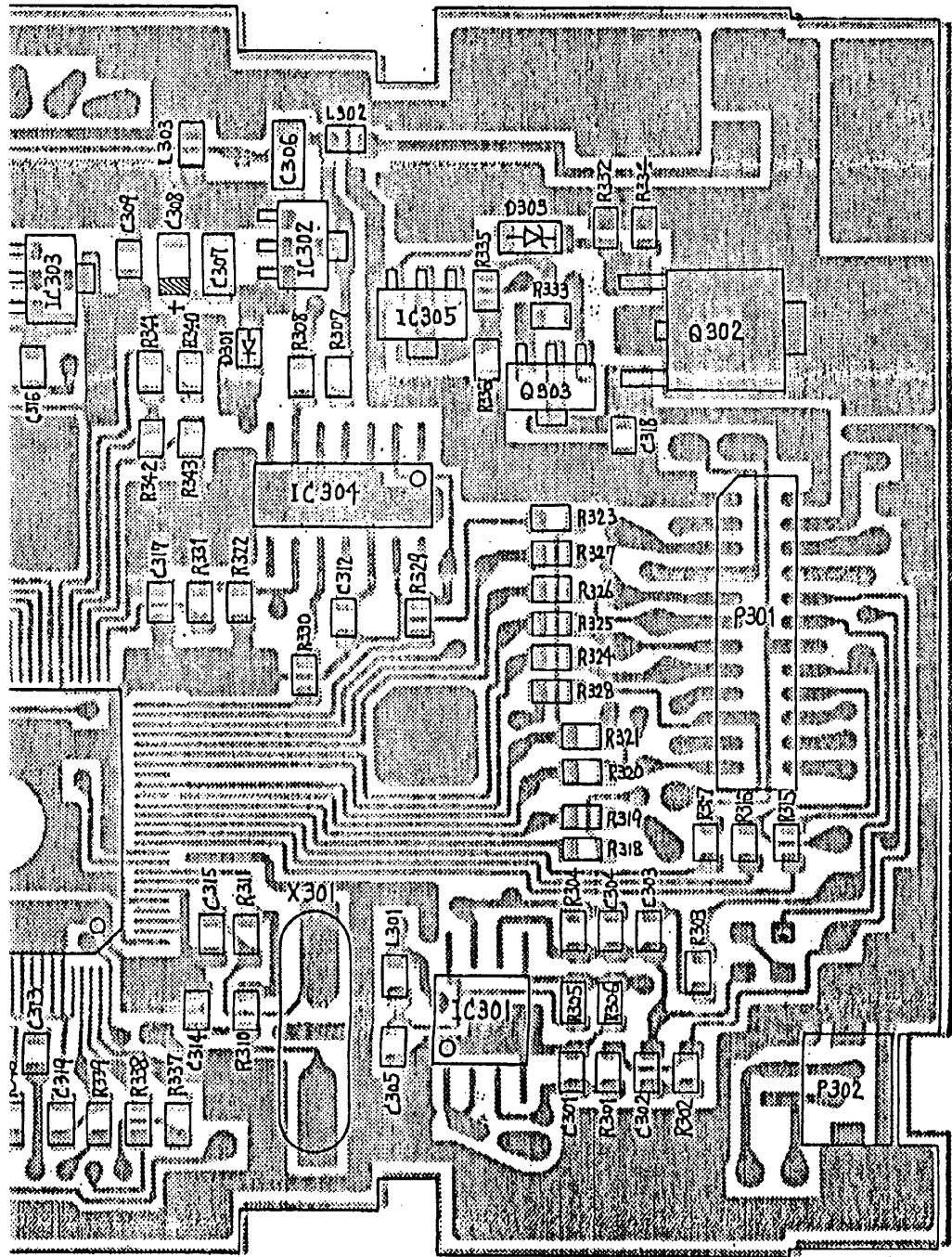

REVISIONS:					
REV	LOT#	DATE	REV BY	CHECK BY	
0					

1K	R354	100K	C301	0.1/B (2125)
100K	R355	100K	C302	0.1/B (2125)
120K	R358	100K	C303	0.1/B (2125)
1K	R357	100K	C304	68P/CH (2125)
1K	R358	100K	C305	0.1/B (2125)
1K	R350	100K	C306	1/P (3216)
1K	R300	100K	C307	1/F (3216)
10K	R361	100K	C308	7V10(T) C-241
10K	R362	0	C300	0.1/B (2125)
10K			C310	0.1/B (2125)
390			C311	0.001/B (2125)
390			C312	0.1/B (2125)
1K			C313	0.1/B (2125)
1K			C314	22P/CH (2125)
1K			C315	22P/CH (2125)
10K			C316	0.001/B (2125)
1K			C317	0.1/B (2125)
100K			C318	0.1/D (2125)
100K			C318	0.1/B (2125)
100K			C320	0.1/B (2125)

NOTES:  
 1. RESISTANCE VALUES ARE SHOWN IN OHMS UNLESS OTHERWISE NOTED. 1K-KILO OHM, M-MEG OHM  
 2. RESISTOR WATTAGES ARE 1/10W UNLESS OTHERWISE NOTED.  
 3. CAPACITANCE VALUES ARE INDICATED IN MICRO FARADS UNLESS OTHERWISE NOTED. 1P-MICRO-MICRO FARAD

DESIGN BY	DRAWN BY	UNIDEN NO.	MODEL NO.
	94-12-20	UB-247 B	MBC3000XL T
	Y.HOSHI		TITLE MICOM PCB
CHECK BY	APPRO BY		PARTS ASSEMBLY TOP VIEW
94-12-22	94-12-22		DRAWING NO.
Y.HOSHI	K/1/2		E22-11395
REV. NO.			UNIDEN CORP.

UNIDEN  
 HATTIES NC  
 CENTRALIZED DOCUMENT  
 CONTROL CENTER  
 REFERENCE COPY  
 FEB 01 1998  
 04-5524

MASTIN COPY  
 JAN 05 1998

6.12.27