

Chopper Circuits Using RCA MOS Field-Effect Transistors

by

F. M. Carlson

Although electromechanical relays have long been used to convert low-level dc signals into ac signals or for multiplex purposes, relays are seriously limited with respect to life, speed, and size. Conventional (bipolar) transistors overcome the inherent limitations of relays, but introduce new problems of offset voltage and leakage currents. This Note describes the use of MOS field-effect transistors in solid-state chopper and multiplex designs that have the long life, fast speed, and small size of bipolar-transistor choppers, but eliminate their inherent offset-voltage and leakage-current problems.

Basic Chopper Circuits

Chopper circuits are basically of either the shunt type or the series type, as shown in Fig. 1, or a combination of the two.

The shunt chopper circuit, shown in Fig. 1(a), operates as follows: When the switch S is opened, a voltage that is directly proportional to the input signal appears across the load. When the switch is closed, all of the input signal is shorted to ground. Therefore, if the switch is opened and closed periodically, the voltage across the load appears as a square wave that has an amplitude directly proportional to the input signal. This square wave may be highly amplified by a relatively drift-free, stable-gain ac amplifier. This procedure is generally used in low-level dc amplifiers, i.e., a small dc input is chopped, the resulting ac signal is amplified, and the output of the ac amplifier is rectified to produce a dc output directly proportional to the input.

The series chopper circuit, shown in Fig. 1(b), can also be used to chop dc signals. This type of circuit is

particularly useful in telemetry or other systems in which a signal source such as a transducer is to be connected periodically to a load such as a transmitter.

An ideal chopper is simply an on-off switch that has certain desirable characteristics. Table I lists

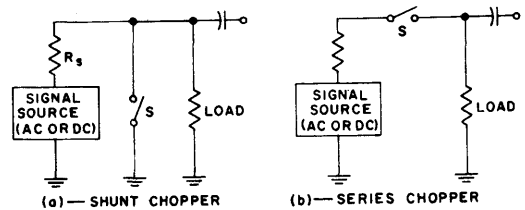

Fig. 1 - Basic chopper circuits.

Ideal Chopper Characteristics	Available Chopper Devices Compared to Ideal		
	MOS	Bipolar	Electromechanical Relay
Infinite Life	Good	Good	Poor
Infinite Frequency Response	Good	Good	Poor
Infinite OFF Resistance	Good	Fair	Good
Zero ON Resistance	Poor	Fair	Good
Zero Driving-Power Consumption	Good	Fair	Fair
Zero Offset Voltage	Good	Poor	Good
Zero Feedthrough between the driving signal and signal being chopped	Fair	Fair	Good
Small Size	Good	Good	Poor

Table I - Comparison of available chopper devices with an ideal.

some of these characteristics, and shows the relative merits of relays, bipolar transistors, and MOS transistors in each area.

Use of MOS Transistors as Choppers

Fig.2 shows voltage-current characteristics of an n-channel depletion-type MOS field-effect transistor such as the RCA-40460. Fig.3 shows an expanded view of the curves in Fig.2(a) in the region about the origin.

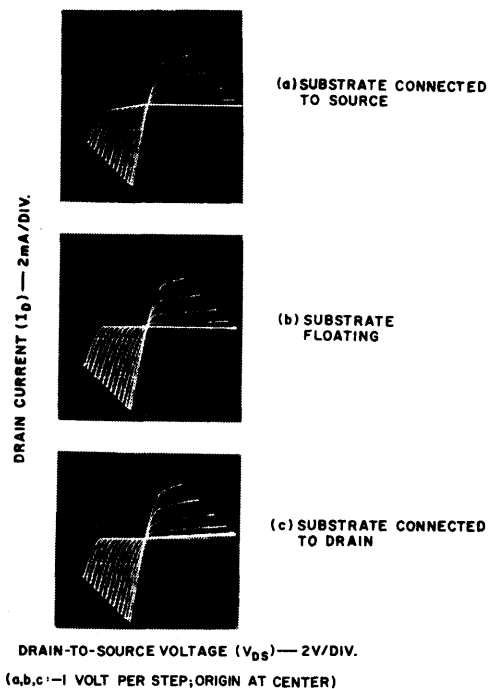

Fig.2 - Voltage-current characteristics of an n-channel depletion-type MOS transistor: (a) with substrate connected to source; (b) with substrate floating; (c) with substrate connected to drain.

Because each curve passes through the origin, the MOS transistor is said to have zero offset voltage. In an MOS shunt chopper circuit, therefore, the output is zero when the input voltage is zero. This result is not obtained with bipolar transistors. Even for zero input voltage, a bipolar transistor has an offset voltage equivalent to the collector-to-emitter saturation voltage $V_{CE(sat)}$ between its collector and emitter terminals. MOS transistors have no parameter comparable to $V_{CE(sat)}$.

When the gate-to-source voltage V_{GS} is zero, an MOS transistor such as the 40460 has an effective resistance of 200 to 300 ohms between its drain and source terminals. If the gate-to-source voltage is made positive, this resistance decreases to about 100 ohms (typically to 90 ohms for the 40460). No significant

increase in gate current occurs when V_{GS} is made positive because the gate of an MOS transistor is insulated from the source-to-drain channel by an oxide layer. (In a junction-gate field-effect transistor, the gate and the channel form a p-n junction, and low gate current can be obtained only when this junction is reverse-biased.) When the resistance between the drain and source terminals is low (100 to 300 ohms), an MOS transistor is said to be ON; the drain-to-source channel resistance is then designated as $r_{ds(ON)}$. This ON condition corresponds to the closed-switch condition in the circuits of Fig.1.

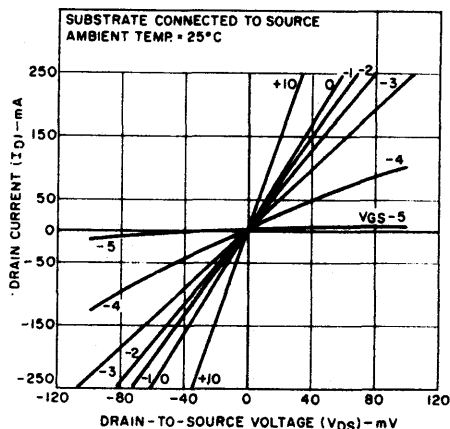

Fig.3 - Low-level drain current as a function of drain-to-source voltage in an n-channel depletion-type MOS transistor with substrate connected to source.

When a negative voltage of about -6 volts or more is applied between the gate and the source of the MOS transistor, the channel resistance between drain and source becomes extremely high (typically thousands of megohms). In this condition, which is known as "cut-off" or "pinch-off", it is impractical to measure the channel resistance directly; instead, the leakage current that flows from drain to source at cutoff is normally specified. This current $I_D(OFF)$, is typically 0.1 nanoampere for the 40460. Because $I_D(OFF)$ is measured at a drain-to-source voltage of 1 volt, the equivalent channel resistance is 10,000 megohms. This OFF condition corresponds to the open-switch condition in the circuits of Fig.1.

Fig.4 shows three basic chopper circuits using the MOS field-effect transistor. The gating signal for the 40460 should swing from zero to at least -6 volts, and may cover a range as large as ± 10 volts. The substrate (and thus the case) of the 40460 transistor is usually connected to the source. However, if the incoming

AN-3452

signal to be chopped exceeds -0.3 volt, the substrate must be "floated", connected to the drain, or biased negatively so that the source-to-substrate and drain-to-substrate voltages never exceed -0.3 volt. If this

state conditions in an MOS shunt chopper. For the ON condition, the output voltage E_O is given by

$$E_O = E_S \left[\frac{\frac{r_{ds} R_L}{r_{ds} + R_L}}{R_S + \frac{r_{ds} R_L}{r_{ds} + R_L}} \right] \quad (1)$$

In Eq.(1), it is assumed that the gate leakage resistance R_G is much larger than the drain-to-source resistance r_{ds} . If the load resistance R_L is also much larger than r_{ds} ; Eq.(1) can be simplified as follows:

$$E_O = E_S \left[\frac{r_{ds}}{R_S + r_{ds}} \right] \quad (2)$$

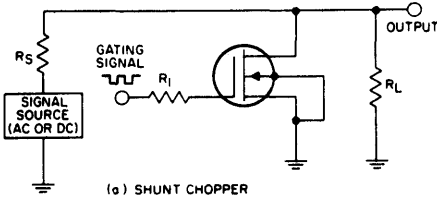

(a) SHUNT CHOPPER

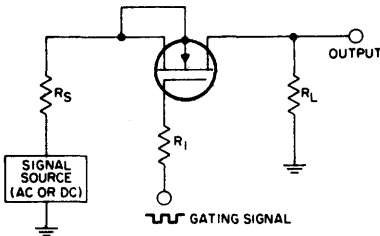

(b) SERIES CHOPPER

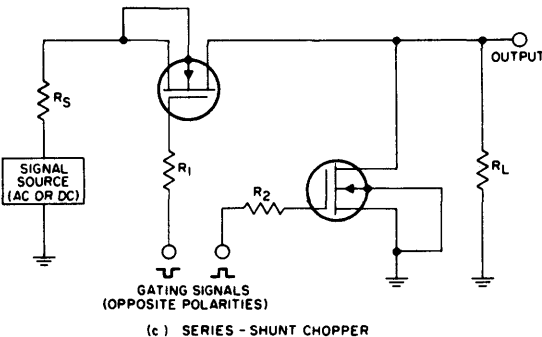

(c) SERIES - SHUNT CHOPPER

Fig.4 - Basic MOS chopper circuits.

value is exceeded, the substrate, which forms two p-n junctions with the drain and the source, becomes forward-biased and the resulting flow of diode current shunts the incoming signal to ground.

Steady-State Conditions

Ideally, when an MOS transistor in a shunt chopper circuit is ON, the output voltage of the circuit should be zero. Because the drain-to-source resistance r_{ds} is some finite value, however, the output cannot reach true zero. Fig.5 shows an equivalent circuit for steady-

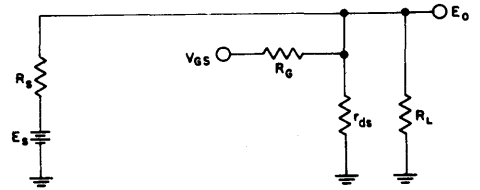

NOTE: ALTHOUGH RESISTANCE R_G IS ACTUALLY DISTRIBUTED ALONG THE LENGTH OF r_{ds} , CONNECTION SHOWN ASSURES A WORST-CASE ANALYSIS.

Fig.5 - Steady-state equivalent circuit of MOS shunt chopper.

For E_O to approach zero, it is necessary that the source resistance R_S be much greater than r_{ds} . The value of E_O is then given by

$$E_O = E_S (r_{ds}/R_S) \quad (3)$$

A typical value for R_S and R_L in an MOS shunt chopper is 0.1 megohm. A typical value of $r_{ds}(ON)$ for the 40460 transistor is 90 ohms. If these values are substituted in Eq.(3) and the signal voltage E_S is assumed to be 1 millivolt, E_O is calculated as follows:

$$E_O = 10^{-3} (90/10^5) = 0.9 \text{ microvolt}$$

In the ON condition, therefore, the dc error voltage is less than 0.1 per cent for the values used, and is directly proportional to the input signal.

For the OFF condition, the steady-state output voltage E_O is given by

$$E_O = E_S \left[\frac{\frac{r_{ds} R_L}{r_{ds} + R_L}}{R_S + \frac{r_{ds} R_L}{r_{ds} + R_L}} \right] + V_{GS} \left[\frac{\frac{r_{ds} R_L}{r_{ds} + R_L}}{R_G + \frac{r_{ds} R_L}{r_{ds} + R_L}} \right] \quad (4)$$

In most MOS transistors, both $r_{ds}(\text{OFF})$ and R_G are much greater than R_L . Therefore, Eq.(4) may be simplified as follows:

$$E_O = E_S \frac{R_L}{R_S + R_L} + V_{GS} \frac{R_L}{R_G} \quad (5)$$

If R_S , R_L , and E_S are assumed to have the values used previously, the gate-to-source voltage V_{GS} is assumed to be -10 volts, and the gate resistance R_G is assumed to be 10^{12} ohms (minimum permissible gate resistance for the 40460), the value of E_O is calculated as follows:

$$\begin{aligned} E_O &= 10^{-3} \left[\frac{10^5}{2 \times 10^5} \right] - 10 \left[\frac{10^5}{10^{12}} \right] \\ &= \frac{10^{-3}}{2} - 10^{-6} \approx 0.5 \text{ millivolt} \end{aligned}$$

The second term in Eq.(5) is the error term for the OFF condition; it is not proportional to the input signal E_S . For the numbers used, the output error in the OFF condition is only 0.2 per cent. If a typical value of 10^{14} ohms is used for the 40460 gate resistance instead of the minimum value of 10^{12} ohms, the error voltage is reduced to only 0.002 per cent. The output error remains small for any value of signal voltage E_S that does not approach the error voltage in magnitude.

Because the error voltage is inversely proportional to the gate leakage resistance R_G , most junction gate field-effect transistors produce larger error voltages than MOS transistors (the minimum R_G of most junction-gate devices is only 1 to 10 per cent that of MOS transistors).

A similar procedure may be used for analysis of series chopper and series-shunt chopper circuits.

The operation of all MOS chopper circuits is greatly affected by the magnitude of the source and load resistances. Table II lists the output voltages of the three basic chopper circuits for various combinations of source and load resistances. It is assumed that the input voltage E_S is 1 millivolt, and that the drain-to-source resistance r_{ds} is 100 ohms in the ON condition and 1000 megohms in the OFF position. The gate leakage resistance R_G (10^{12} ohms or more) is neglected. The following conclusions can be drawn from the data shown:

1. Only the series or the series-shunt circuit should be used when $R_S < r_{ds}(\text{ON})$.
2. In general, R_L should be high. ($R_L \gg r_{ds}(\text{ON})$)
3. The load resistance should be higher than the source resistance. ($R_L \geq R_S$)

4. The performance of the series-shunt circuit is equal to or better than that of either the series or the shunt chopper alone for any combination of R_S and R_L .

Source Resistance R_S (ohms)	Load Resistance R_L (ohms)	Approximate Output Voltage $E_O - \mu V$ (Max. Output = 1 mV)					
		Shunt Chopper		Series Chopper		Series-Shunt Chopper	
		(ON)	(OFF)	(ON)	(OFF)	(ON)	(OFF)
1 M	1 M	0.1	500	500	1	500	0.0001
100 K	1 M	1	900	900	1	900	0.0001
100	1 M	500	1000	1000	1	1000	0.0001
0	1 M	1000	1000	1000	1	1000	0.0001
1 M	100 K	0.1	90	90	0.1	90	0.0001
1 M	100	0.05	0.1	0.1	0.0001	0.1	0.00005
100 K	100 K	1	500	500	0.1	500	0.0001
100	100	333	500	333	0.0001	333	0.00005

Table II - Steady-state chopper output voltage for various source and load resistances.

Transient Conditions

Fig.6 shows the ac equivalent circuit of an MOS shunt chopper. The interelectrode capacitances of the MOS transistor affect operation of the circuit at high frequencies. The input capacitance C_{gs} increases the rise time of the gate driving signal and thus increases the switching time of the chopper. This effect is not usually a serious limitation, however, because the

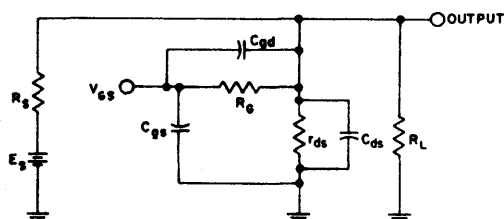

Fig.6 - AC equivalent circuit of MOS shunt chopper.

switching time of the MOS transistor depends primarily on the input and output time constants. Switching times as short as 10 nanoseconds can be achieved when an MOS transistor is driven from a low-impedance generator and the load resistance is less than about 2000 ohms.

The output capacitance C_{ds} also tends to limit the maximum frequency that can be chopped. When the reactance of this capacitance becomes much lower than the load resistance R_L , the chopper becomes ineffective because $X_{C_{ds}}$ is essentially in parallel with R_L and $r_{ds}(\text{OFF})$.

AN-3452

The feedthrough capacitance C_{gd} is the most important of the three interelectrode capacitances because it couples a portion of the gate drive signal into the load circuit and causes a voltage spike to appear across R_L each time the gate drive signal changes state. C_{gd} and R_L form a differentiating network which allows the leading edge of the gate drive signal to pass through. The output capacitance C_{ds} is beneficial to the extent that it helps reduce the amplitude of the feedthrough spike.

The effect of the feedthrough spikes can be reduced by several methods. Typical approaches include the following:

- use of a clipping network on the output when the input signal to be chopped is fixed in amplitude,
- use of a low chopping frequency,
- use of an MOS transistor that has a low feedthrough capacitance C_{gd} (some RCA MOS transistors have typical C_{gd} values as low as 0.13 picofarad),

(d) use of a gate drive signal that has poor rise and fall times,

(e) use of a source and load resistance as low as feasible,

(f) use of a shield between the gate and drain leads,

(g) use of a series-shunt chopper circuit.

Temperature Variations

The variation of MOS transistor parameters with temperature can affect the operation of a chopper circuit unless allowance is made for such variations in the circuit design. It is important, therefore, to determine the approximate degree to which each parameter can be expected to change with temperature. Fig.7 shows curves of channel resistance r_{ds} , gate leakage current

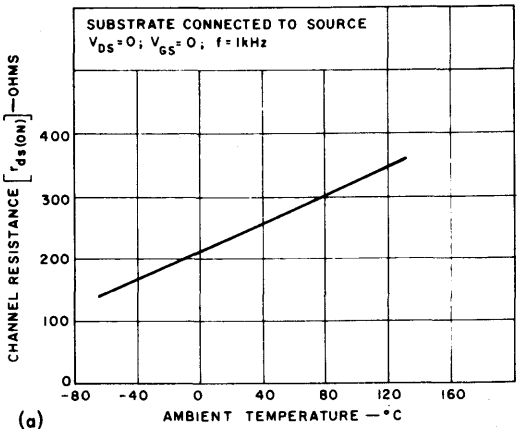

(a)

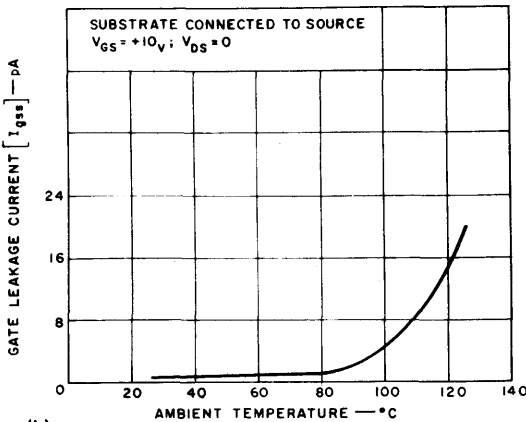

(b)

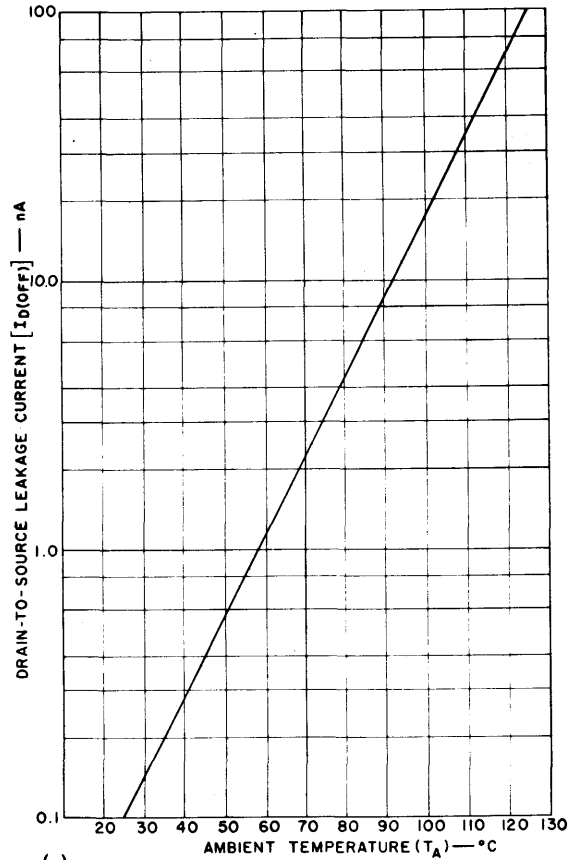

(c)

Fig.7 - Variation of 40460 parameters with ambient temperature: (a) channel resistance r_{ds} ; (b) gate leakage current I_{GS} ; (c) drain-to-source leakage current $I_{D(OFF)}$.

I_{gss} , and drain-to-source leakage current $I_{D(OFF)}$ as a function of temperature for the 40460. I_{gss} and $I_{D(OFF)}$ were not measured at temperatures below 25° C because condensation and frost that form on the test chassis result in erroneous and/or erratic readings of pico-ampere currents. Test circuits used to measure these parameters are shown in the Appendix.

Typical Circuits

Fig.8 shows three chopper circuits that were constructed for demonstration purposes: (a) a shunt chopper, (b) a series chopper, and (c) an ac chopper. The 0.005-microfarad capacitor across the gate drive generator in

It is recommended that MOS choppers be driven from a square-wave source. Fig.10 shows the feed-through that results when the circuits of Figs.8(a) and 8(b) are driven from a sine-wave generator instead of a square wave.

Fig.11 shows how the circuit of Fig.8(c) can be used to chop an rf signal at either a slow or a fast chopping frequency. The 40460 transistor can be used to chop rf signals extending up to the low vhf region. The frequency of the gate drive signal can be as high as several hundred kilohertz before excessive degradation of the square wave occurs. The rise time of the

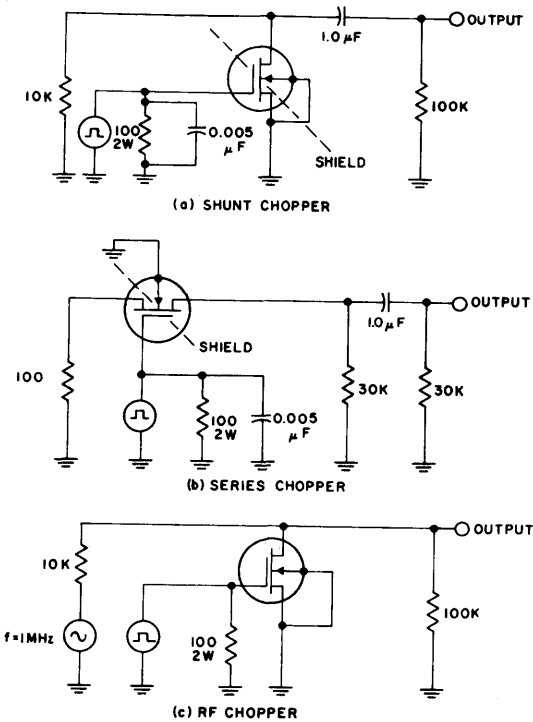

Fig.8 - Typical MOS chopper circuits: (a) shunt chopper; (b) series chopper; (c) rf chopper.

circuits (a) and (b) increases the rise time of the gate drive signal. A resistor is used in each circuit to simulate the impedance of the signal source. The actual input voltage was set at zero so that spike feedthrough and offset voltages could be measured. The dc offset voltage, which is caused primarily by the average value of the spikes over the whole cycle, was too small to be measured on the equipment available. Fig.9 shows the actual spike feedthrough for the 40460 and 3N128 MOS transistors in the shunt and series circuits of Figs.8(a) and 8(b); the rise time of the gate drive signal was 1 microsecond.

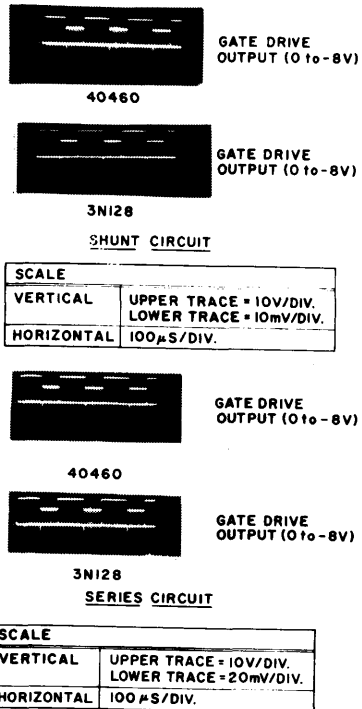

Fig.9 - Actual spike feedthrough in shunt and series chopper circuits employing the 40460 and 3N128 MOS transistors.

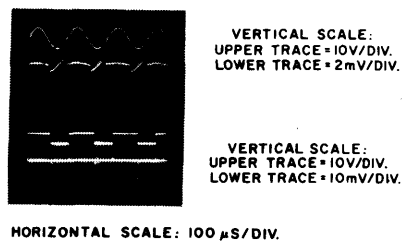

Fig.10 - Comparison of sine- and square-wave gate drive for an MOS shunt chopper employing the 40460.

AN-3452

gate drive signal for the circuit of Fig. 8(c) was 15 nanoseconds.

In field-effect-transistor choppers using a version of the series-shunt circuit shown in Fig.8(c), noise and

offset voltages as low as 10 microvolts or less have been obtained.¹ Balanced MOS chopper circuits using special compensating networks have also been developed to chop 0.1-microvolt signals at impedance levels up to 40,000 ohms and chopping frequencies up to 250 Hz.²

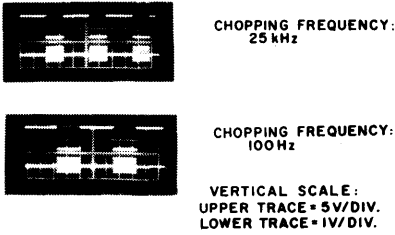

Fig.11 - Results of using MOS *rf* chopper at a fast and a slow chopping frequency.

REFERENCES

1. "Airpax Electronics", ELECTRONICS, March 20, 1967, page 61.
2. J.J. Hitt and G. Mosley, "FET Chopper Circuits for Low-Level Signals", 1967 IEEE CONVENTION DIGEST, page 488.

APPENDIX

Test Circuits

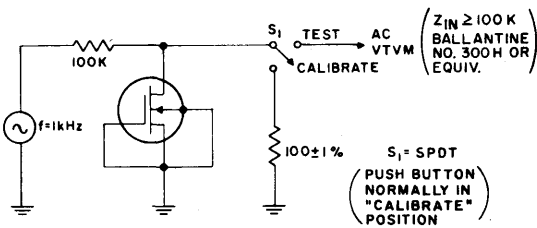

Fig.A-1 - Channel resistance ($r_{dS(ON)}$) measurement circuit.

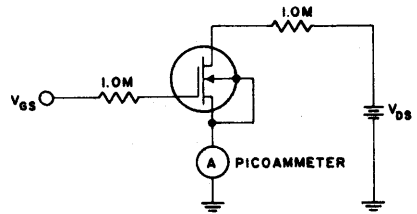

Fig.A-2 - Cutoff current ($I_{D(OFF)}$) measurement circuit.

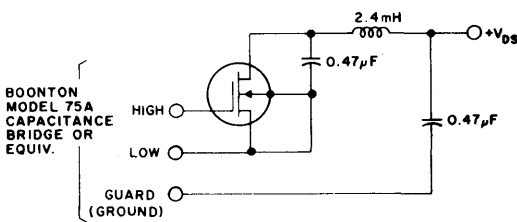

Fig.A-3 - Input capacitance (C_{ISS}) measurement circuit.

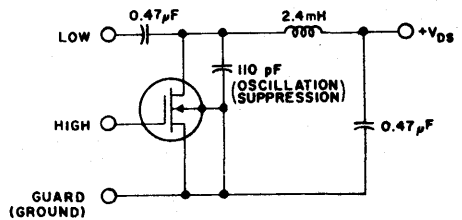

Fig.A-4 - Reverse transfer (Feedback) capacitance (C_{RSS}) measurement circuit.