

Half-Bridge Push-Pull Converter

[Main page](#) | [How to use the program](#) | [Function principals](#) | [Mathematics used in the program](#) | [Help for HF transformer](#)
 Top of page | [Application](#) | [Tips](#) | [Literature Notes](#) | [Help for choking coils](#)

How to use the program

Reference: The shapes of current and voltage curves are calculated using Faraday's Law. They do not represent an incremental simulation like it is done normally by programs like P-Spice. In the calculations the forward voltages of the diodes are considered with $V_F = 0.7V$, and the transistors are interpreted as ideal switches.

- The values of all input fields can be changed.
- If an input field is left empty, a default value is chosen. This value is displayed after leaving the input field in question.
- The switch mode power supply operates within a certain input range i.e. between V_{in_min} and V_{in_max} .

Note:

- For the european mains of 230V +/-10% and behind the rectifier and the smoothing (with a voltage ripple of 10%) the input voltage range is between $V_{in_min} = 250V$ and $V_{in_max} = 360V$.
- For wide range Switch Mode Power Supplies the input voltage range of the mains is from 100Vac -10% (Japan) to 240Vac +6% (Great Britain). In this case, the DC input range of the power supply is from $V_{in_min} = 110V$ to $V_{in_max} = 360V$.
- For use of a power factor pre-regulator the input voltage range is normally from $V_{in_min} = 360V$ to $V_{in_max} = 400V$.
- The program needs the output values V_{out} and I_{out} .
- The switching frequency f is the operating frequency of the transistor.
- If the field "proposal" is activated for the inductor L , a value for L and the corresponding current ripple ΔI_L is proposed. These values are laid out such that $\Delta I_L = 0.4I_{out}$ with V_{in_max} as the input voltage.
- If the field "proposal" for the input field " N_1/N_2 " is activated, the turns ratio N_1/N_2 is proposed. This suggestion is chosen such that the required output voltage can be achieved using V_{in_min} as an input voltage.
- If you do not agree with our proposals, you can change N_1/N_2 or L as well as ΔI_L . The field "proposal" is then deactivated automatically.
- The value V_{in} is the value for the calculation of the current and voltage diagrams on the right side of the display. V_{in} must lie between V_{in_min} and V_{in_max} .

[Top of page](#)

Application

The **Half-Bridge Push-Pull Converter** belongs to the primary switched converter family since there is isolation between input and output. It is suitable for output powers up to 1kW.

[Top of page](#)

Function principals

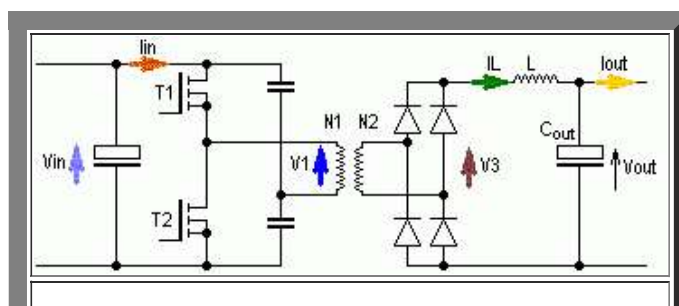

Illustration 1: Half-Bridge Push-Pull Converter

For the following analysis it will be assumed that the transistor is simplified as an ideal switch and the diode has no forward voltage drop. In the program itself, the diode will take into account a forward voltage drop $V_F = 0.7V$.

The Push-Pull converter drives the high-frequency transformer with an AC voltage, where the negative as well as the positive half swing transfers energy. The capacitor-bridge generates, in its centre point, a voltage of $\frac{1}{2} V_{in}$.

The primary transformer voltage V_1 can be $+\frac{1}{2} V_{in}$, $-\frac{1}{2} V_{in}$ or *zero* depending on whether the upper transistor, the lower transistor or neither is on.

On the secondary side, the AC voltage is rectified, so that V_3 is a pulse-width-modulated voltage which switches between $\frac{1}{2} \cdot V_{in} \cdot (N_2/N_1)$ and zero. Due to the rectification, the pulse-frequency of V_3 is equal to $2 \cdot f$.

The Low-Pass filter, formed by the inductor L and the output capacitor C_{out} , produces the average value of V_3 . For continuous mode (I_L never becomes zero) this leads to:

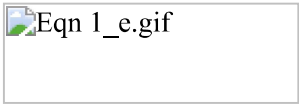

Eqn 1_e.gif

The Duty cycle of this converter may theoretically increase to 100%. In practice this is not possible because the serial connected transistors, T_1 and T_2 , have to be switched with a time difference to avoid a short circuit of the input supply.

Due to the fact that the duty cycle t_1/T can theoretically increase to 100%, it follows for the turns ratio that:



Eqn 2_e.gif

In the program, this value is multiplied by a factor of 0.95, so that the proposed value for N_1/N_2 includes a small margin which guarantees the demagnetisation of the core, when the input voltage is minimal, (remember: at minimum input voltage the duty cycle reaches its maximum).

For the allocation of the inductor L , the same rules as for the [Buck Converter](#) can be used. One also distinguishes between **discontinuous** and **continuous mode**, depending on whether or not the inductor current falls to zero during the on-time of the transistor.

During continuous operation:

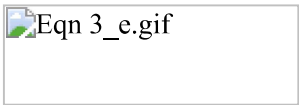

Eqn 3_e.gif

- In continuous mode the output voltage depends only on the duty cycle and the input voltage, it is load independent.

The inductor current I_L has a triangular shape and its average value is determined by the load. The change in inductor current ΔI_L is dependent on L and can be calculated with the help of Faraday's Law.

During continuous mode, with $V_{out} = V_{in} \cdot (N_2/N_1) \cdot t_1/T$ and a chosen switching frequency f it can be shown that:



Eqn 4

- The change in inductor current is load independent. The output current I_{out} is taken to be the average value of the inductor current I_L .

For a small load current, namely if $I_{out} < \Delta I_L/2$, the current will fall to zero during every period. This is what is known as **discontinuous mode**. In this case the calculations stated above are no longer valid.

In that moment, when the inductor current becomes zero, the voltage V_3 jumps to the value of V_{out} . The diode junction capacitance of the secondary rectifier forms a resonant circuit with the inductance, which is activated by the voltage jump at the rectifier. The voltage V_3 then oscillates and fades away.

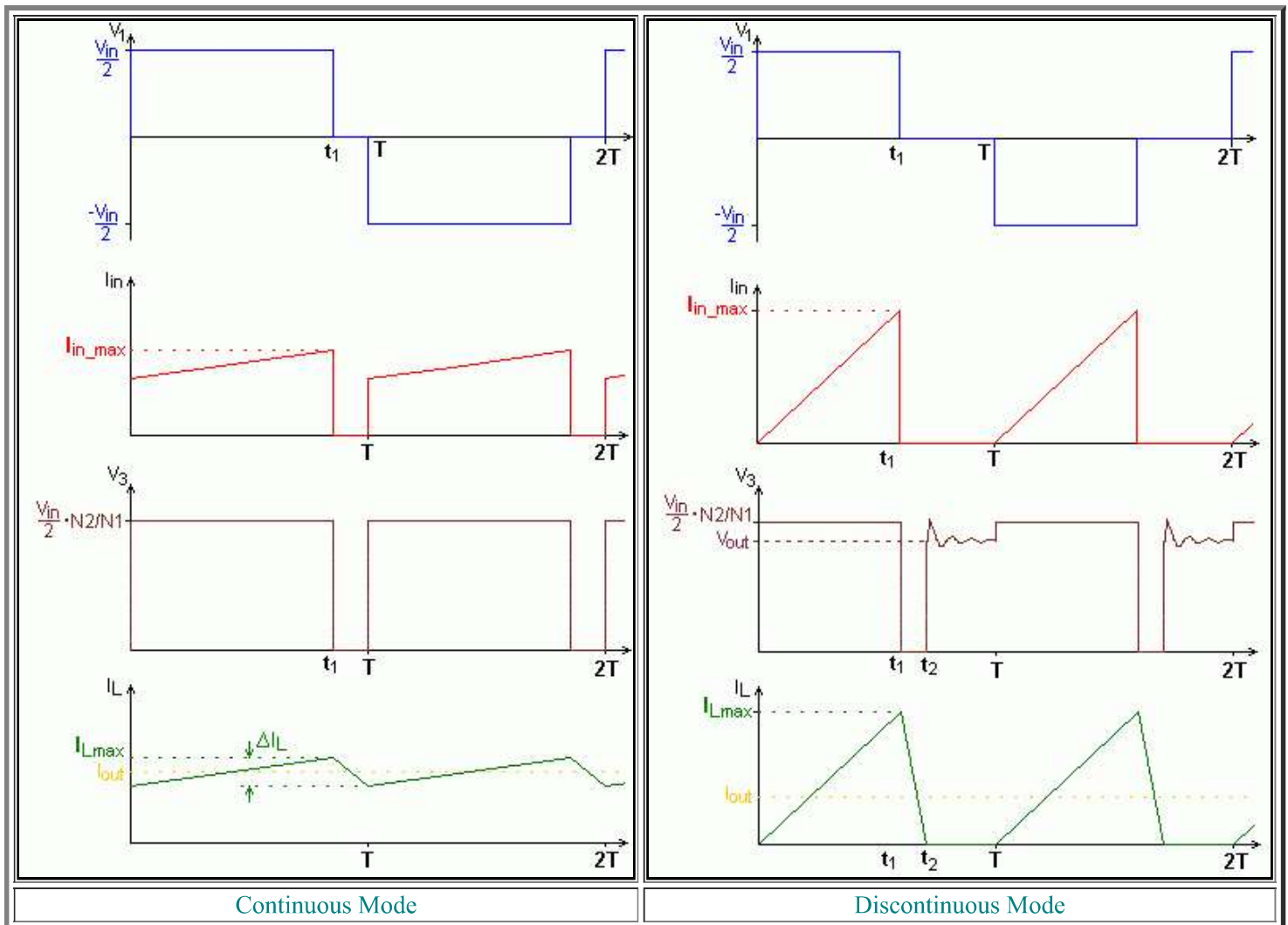

Illustration 2: Operating modes of the Half-Bridge Push-Pull Converter

[Top of page](#)

Tips

- The larger the chosen value of the inductor L , the smaller the current ripple ΔI_L . However this results in a physically larger and heavier inductor.
- The higher the chosen value of the switching frequency f , the smaller the size of the inductor. However the switching losses of the transistor also become larger as f increases.
- The smallest possible physical size for the inductor is achieved when $\Delta I_L = 2I_{out}$ at V_{in_max} . However, the switching losses at the transistors are at their highest in this state.
- Choose ΔI_L so that it is not too big. The suggestions proposed by us have adequately small current ripple along with physically small inductor size. With a larger current ripple, the voltage ripple of the output voltage V_{out} becomes clearly bigger while the physical size of the inductor decreases marginally.
- It is best not to alter the turns ratio N_1/N_2 proposed by us.

[Top of page](#)

Mathematics used in the program

The following parameters must be entered into the input fields:

V_{in_min} , V_{in_max} , V_{out} , I_{out} and f

Using these parameters, the program produces a **proposal for N_1/N_2 and L** :

 Eqn 5.0

(the factor of 0.95 is taken into account to allow for the fact that the duty cycle $t_1/T = 1$ cannot be completely reached).

 Eqn 5.1

 Eqn 5.2

$V_F = 0.7$ (Diode Forward-voltage)

$\Delta I_L = 0.4 I_{out}$

For the calculation of the curve-shapes, and also for the calculation of " ΔI_L for V_{in_max} ", two cases have to be distinguished, i.e. *continuous mode* and *discontinuous mode*:

 Eqn 5.3

 Eqn 5.4

From this it follows that:

a. For $\Delta I_L < 2I_{out}$ the converter is in continuous mode and it follows that:

 Eqn 6.0

 Eqn 6.1

 Eqn 6.2

b. For $\Delta I_L > 2I_{out}$ the converter is in discontinuous mode and it follows that:



[Main page](#) | [How to use the program](#) | [Function principals](#) | [Mathematics used in the program](#) | [Help for HF transformer](#)
[Top of page](#) | [Application](#) | [Tips](#) | [Literature Notes](#) | [Help for choking coils](#)