

20 Watt Simple Switcher Forward Converter

National Semiconductor
Application Note 776
Frank DeStasi
Tom Gross



A 20W, 5V at 4A, step-down regulator can be developed using the LM2577 Simple Switcher IC in a forward converter topology. This design allows the LM2577 IC to be used in step-down voltage applications at output power levels greater than the 1 A LM2575 and 3 A LM2576 buck regulators. In addition, the forward converter can easily provide galvanic isolation between input and output.

The design specifications are:

V_i Range	: 20V–24V
V_o	: 5V
$I_o(\text{max})$: 4A
ΔV_o	: 20 mV

With the input and output conditions identified, the design procedure begins with the transformer design, followed by the output filter and snubber circuit design.

TRANSFORMER DESIGN

1. Using the maximum switch voltage, input voltage, and snubber voltage, the transformer's primary-to-clamp windings turns ratio is calculated:

$$V_{SW} \geq V_{i_{\text{max}}} + V_{i_{\text{max}}} (N_p/N_c) + V_{\text{snubber}}$$

$$N_p/N_c \leq (V_{SW} - V_{i_{\text{max}}} - V_{\text{snubber}})/V_{i_{\text{max}}}$$

$$N_p/N_c \leq (60V - 24V - 5V)/24V = 1.29$$

$$\Delta \text{ let } N_p/N_c = 1.25$$

The V_{snubber} voltage is an estimate of the voltage spike caused by the transformer's primary leakage inductance.

2. The duty cycle, t_{on}/T , of the switch is determined by the volt-second balance of the primary winding.

During t_{on} ;

$$V_i = L_p (\Delta i/T_{\text{ON}}) \rightarrow \Delta i = (V_i/L_p) t_{\text{on}}$$

During t_{off} ;

$$V_i = (N_p/N_c) = L_p (\Delta i/t_{\text{off}}) \rightarrow \Delta i = (N_p/N_c) (V_i/L_p) t_{\text{off}}$$

Setting Δi 's equal;

$$(V_i/L_p) t_{\text{on}} = (N_p/N_c) (V_i/L_p) t_{\text{off}}$$

$$t_{\text{on}}/t_{\text{off}} = N_p/N_c$$

$$\text{Since } D = t_{\text{on}}/T = t_{\text{on}}/(t_{\text{on}} + t_{\text{OFF}})$$

$$\text{max. duty cycle} = D_{\text{max}} = (N_p/N_c) / [(N_p/N_c) + 1]$$

$$D_{\text{max}} = (1.25) / (1.25 + 1) = 0.56 (56\%)$$

3. The output voltage equations of a forward converter provides the transformer's secondary-to-primary turns ratio:

$$V_o + V_{\text{diode}} \leq V_{i_{\text{min}}} \times D_{\text{max}} (N_s/N_p)$$

$$N_s/N_p \geq (V_o + V_{\text{diode}}) / (V_{i_{\text{min}}} \times D_{\text{max}})$$

$$N_s/N_p \geq (5.5V) / (20V)(56\%) = 0.49$$

$$\Delta \text{ let } N_s/N_p = 0.5$$

4. Calculate transformer's primary inductance by finding the maximum magnetizing current (Δi_{Lp}) that does not allow the maximum switch current to exceed it's 3 A limit (capital I for DC current, Δi for AC current, and lower case i for total current):

$$i_{\text{sw}} = i_{\text{pri}} = i_{L_o} + \Delta i_{Lp}$$

Basic Forward Converter

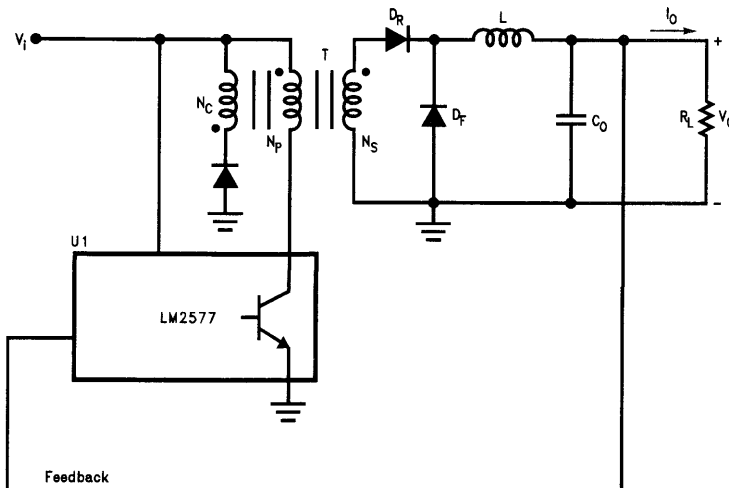

TL/H/11216-1

where i_{L_o} is the reflected secondary current and Δi_{L_P} is the primary inductance current.

$$i_{L_o'} = i_{L_o}(N_s/N_p) \quad (i_{L_o} \text{ reflected to primary})$$

$$i_{L_o} = I_o \pm \Delta i_{L_o}/2$$

Δi_{L_o} is the output inductor's ripple current

$$I_o = I_o \text{ (the load current)}$$

$$i_{L_o'} = (I_o \pm \Delta i_{L_o}/2)(N_s/N_p)$$

$$i_{L_o'}(pk) = (I_o(max) + \Delta i_{L_o}/2)(N_s/N_p)$$

$$i_{sw} = I_{sw} + \Delta i_{sw}$$

$$i_{sw}(pk) = i_{L_o'}(pk) + \Delta i_{L_P}(pk)$$

$$i_{sw}(pk) = (I_o(max) + \Delta i_{L_o}/2)(N_s/N_p) + \Delta i_{L_P}(pk)$$

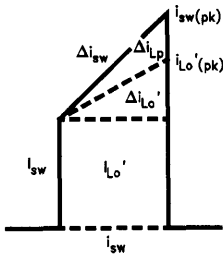
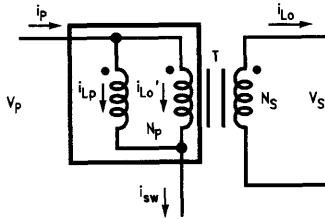

TL/H/11216-2

Using standard inductors, a good practical value to set the output inductor current (Δi_{L_o}) to is 30% of the maximum load current (I_o). Thus;

$$i_{sw}(pk) = (I_o(max) + 0.15\Delta i_{L_o})(N_s/N_p) + \Delta i_{L_P}(pk)$$

$$\Delta i_{L_P}(pk) = i_{sw}(pk) - (I_o(max) + 0.15\Delta i_{L_o})(N_s/N_p)$$

$$\Delta i_{L_P}(pk) = 3A - (4A + 0.15 \times 4A)(0.5) = 0.7A$$

$$L_p = V_{pri} \times \Delta t / \Delta i = (V_i - V_{sat})(t_{on} / \Delta i_{L_P}(pk))$$

$$= (V_{i(max)} - V_{sat})(D_{max} / (\Delta i_{L_P}(pk) \times f))$$

$$= (24V - 0.8V)(0.56/0.7 \times 52 \text{ kHz})$$

$$L_p = 357 \mu H \quad \Delta \text{let } L_p = 350 \mu H$$

OUTPUT FILTER—INDUCTOR

The first component calculated in the design is the output inductor, using the current-to-voltage relationship of an inductor:

$$V_L = L_o (\Delta i_{L_o} / t_{on})$$

Choosing an inductor ripple current value of $0.3I_o$ and a maximum output current of 4A:

$$\Delta i_{L_o} = 0.3 (4A) = 1.2A$$

During t_{on} :

$$V_L = V_S - V_D - V_o \text{ [where } V_S = (V_i - V_{sat})(N_s/N_p)]$$

Thus,

$$[(V_i - V_{sat})(N_s/N_p) - V_d - V_o] = L_o (\Delta i_{L_o} / D) f$$

$$L_o = [(V_i - V_{sat})(N_s/N_p) - V_d - V_o] \times D / \Delta i_{L_o} \times f$$

$$L_o = [(24V - 0.8V)(0.5) - 0.5V - 5V] 56\% / 1.2A \times 52 \text{ kHz}$$

$$L_o = 55 \mu H \quad \Delta \text{let } L_o = 60 \mu H$$

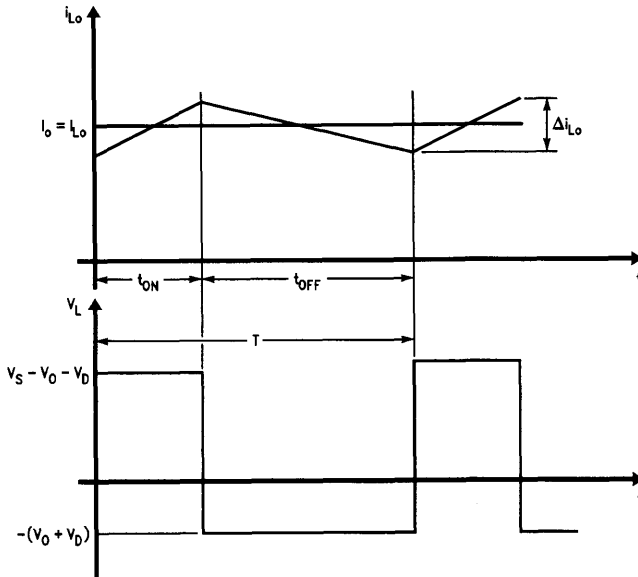

TL/H/11216-3

OUTPUT FILTER—CAPACITOR

Since the output capacitor's current is equal to inductor's ripple current, the output capacitor's value can be found using the inductor's ripple current. Starting with the current-voltage relationship, the output capacitance is calculated:

$$\begin{aligned}\Delta V_O &= 1/C_O \int i dt \\ &= \Delta i_{L_O} / 4C_O (TR/2) \\ &= (\Delta i_{L_O} \cdot T) / 8C_O \\ C_O &= (\Delta i_{L_O} \cdot T) / 8\Delta V_O\end{aligned}$$

However, the equivalent series resistance (ESR) of the capacitor multiplied by the inductor's ripple current creates a parasitic output ripple voltage equal to:

$$\Delta V_O = ESR_{CO} \cdot \Delta i_{L_O} = ESR_{CO} \cdot 0.3 I_O$$

This parasitic voltage is usually much larger than the inherent ripple voltage. Hence, the output capacitor parameter of interest, when calculating the output ripple voltage, is the equivalent series resistance (the capacitance of the output capacitor will be determined by the frequency response analysis). Using a standard-grade capacitor with ESR of 0.05Ω produces a total output ripple voltage of:

$$\Delta V_O = 0.05\Omega \cdot 1.2A \approx 60 mV$$

To get output ripple voltage of 20 mV or less (as was part of the design specs) requires a capacitor with ESR of less than 17 mΩ.

SNUBBER CIRCUIT

A snubber circuit (C_S , R_S , D_S) is added to reduce the voltage spike at the switch, which is caused by the transformer's leakage inductance. It is designed as follows: when the switch is off,

$$\begin{aligned}V_R &= V_{CE} - V_{IN} - V_D \\ V_{LL} &= V_D + V_R - V_{IN}(N_p/N_c)\end{aligned}$$

Substituting for V_R , the voltage across the leakage inductance, V_{LL} , is,

$$V_{LL} = V_{CE} - V_{IN}(1 + N_p/N_c)$$

Using the current-voltage relationship of inductors,

$$t_S = I_{PRI}(L_L/V_{LL})$$

Substituting for V_{LL} ,

$$t_S = I_{PRI} L_L / (V_{CE} - V_{IN}(1 + N_p/N_c))$$

Calculating for the average leakage inductance current, $I_{LL(AVE)}$,

$$\begin{aligned}I_{LL(AVE)} &= I_{PRI(MAX)} (t_S) / 2T \\ &= I_{PRI(MAX)}^2 L_L f / 2(V_{CE} - V_{IN}(1 + N_p/N_c))\end{aligned}$$

Solving for the snubber resistor;

$$R_S = V_R / I_{LL(AVE)}$$

Substituting $I_{LL(AVE)}$ and V_R results in,

$$\begin{aligned}R_S &= 2(V_{CE} - V_{IN}(1 + N_p/N_c)) X \\ &\quad (V_{CE} - V_{IN} - V_D) / (L_L (I_{PRI(MAX)})^2 f)\end{aligned}$$

Choosing L_L to equal 10% of L_p ,

$$\begin{aligned}R_S &= 2(65V - 24V - 1V) X (65V - 24V(2.25)) / \\ &\quad (7 \mu H (3A)^2 52 kHz) \\ &= 268.9\Omega \approx 270\Omega\end{aligned}$$

Using the current-voltage relationship of capacitors,

$$\Delta V_R = (T - t_S) I_C / C_S = (T - t_S) V_R / R_S C_S \approx V_R / R_S C_S f$$

The capacitor C_S equates to,

$$C_S = V_R / R_S f \Delta V_R$$

$$C_S = 40V / (270\Omega)(52 kHz) 10V = 0.28 \mu F \approx 0.33 \mu F$$

The snubber diode has a current rating of 1A peak and a reverse voltage rating of 30V.

OTHER COMPONENTS

Diodes, D_R and D_F , used in the secondary are 5A, 30V Schottky diodes. The same diode type is used for D_C , however a lower current diode could have been used.

A compensation network of R_C and C_C optimizes the regulator's stability and transient response and provides a soft-start function for a well-controlled power-up.

The finished circuit is shown below.

5V, 4 A Forward Converter Circuit Schematic

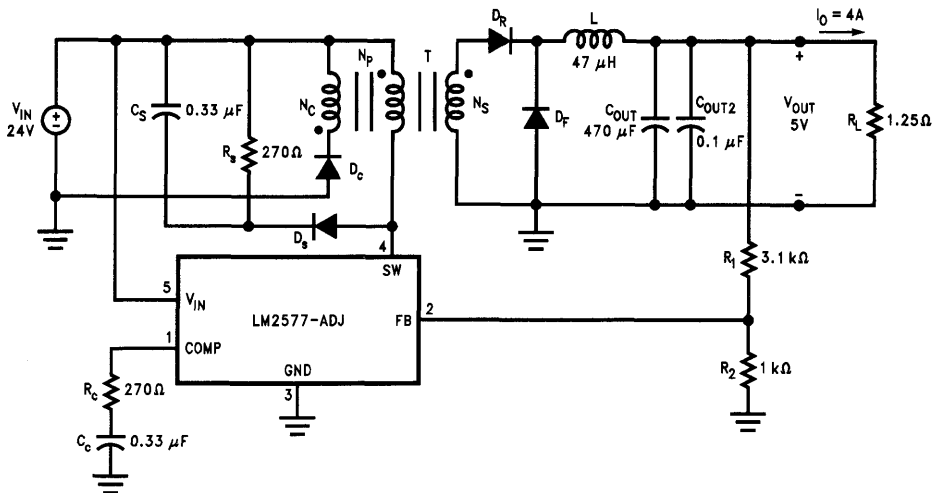

TL/H/11216-4

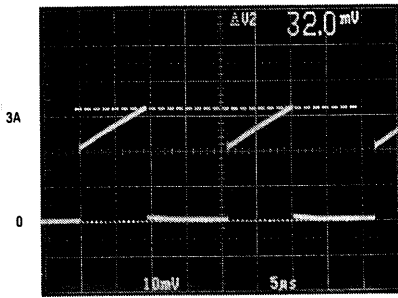

Switch Current

TL/H/11216-5

Vertical: 1 A/div
Horizontal: 5 μ s/div

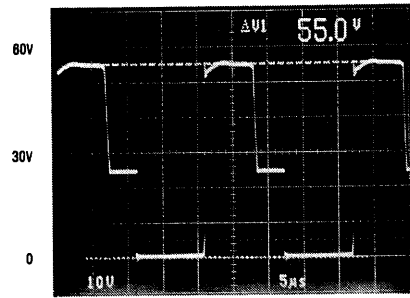

Switch Voltage

TL/H/11216-6

Vertical: 10 V/div
Horizontal: 5 μ s/div

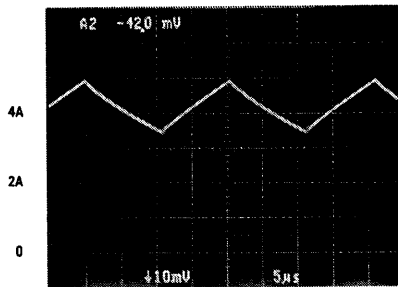

Inductor Current

TL/H/11216-7

Vertical: 1 A/div
Horizontal: 5 μ s/div

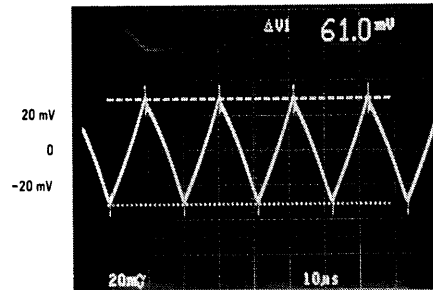

Output Ripple Voltage

TL/H/11216-8

Vertical: 20 mV/div
Horizontal: 10 μ s/div

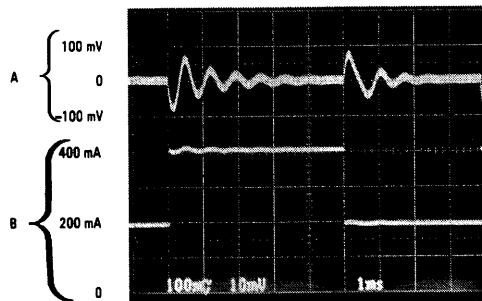

Load Step Response

TL/H/11216-9

A: Output Voltage Change, 100 mV/div
B: Output Current, 200 mA/div
Horizontal: 10 ms/div