

Modeling and analysis of solar-powered electric vehicles

Mandakuriti Nivas¹, Rambilli Krishna Prasad Rao Naidu¹, Debani Prasad Mishra¹,
Surender Reddy Salkuti²

¹Department of Electrical and Electronics Engineering, International Institute of Information Technology (IIIT) Bhubaneswar, Odisha, India

²Department of Railroad and Electrical Engineering, Woosong University, Daejeon, Republic of Korea

Article Info

Article history:

Received Jun 11, 2021

Revised Jan 18, 2022

Accepted Jan 26, 2022

Keywords:

Brushless DC motor
Buck-boost converter
Maximum power point tracker
Perturb and observe
Renewable energy
Solar-powered electric vehicle

ABSTRACT

The emission of greenhouse gasses from transportation vehicles is one of the most alarming environmental threats and the emission of these gases is mounting at a distressing pace. Limited fossil fuel resources are also a threat to the automobile industry. This work aims to describe the solar-powered electric vehicle (SPEV) as the key to solving the downside of fuel and pollution. A battery is used in an electric vehicle (EV) which is charged from both external power supply and also from photovoltaic (PV) panels which absorb radiation from the sunlight and generate electrical power. A maximum power point tracker (MPPT) controller is employed to track the utmost power. A buck-boost converter is utilized to amplify the DC voltage procured from the photovoltaic module and then the boosted output is transmitted to a three-phase voltage source inverter (VSI). VSI is used to transform the solar DC voltage to AC voltage and feeds the brushless direct current (BLDC) motor which controls vehicle applications.

This is an open access article under the [CC BY-SA](https://creativecommons.org/licenses/by-sa/4.0/) license.

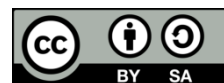

Corresponding Author:

Surender Reddy Salkuti

Department of Railroad and Electrical Engineering, Woosong University

17-2, Jayang-Dong, Dong-Gu, Daejeon-34606, Republic of Korea

Email: surender@wsu.ac.kr

1. INTRODUCTION

Present world transports are completely dependent on combustion engines which power the vehicle causing serious threat to the environment by emission of green gas emission. Even though, there are many changes in the world transport technology from compound fuels to electric vehicles (EVs). Because of high cost and electric vehicle accuracy, many people doubt the new technologies in transportation [1]–[3]. Sun is the main energy source for solar-powered electric vehicles (SPEVs). Zero pollution is possible with SPEVs. SPEVs main advantages are they take energy from the sun, to recycle the energy regenerative braking system is utilized and mechanical losses are less, zero-emission, easy infix, control, and fault critical due to higher energy efficiency [4]. The utilization of EVs personally is very less and their status in the market is not up to the mark because these are needed to be charged for every 60-70 km drive. At present many electric vehicles are getting charged through roadside charging units, and parking stations. Generally, it takes approximately 2 to 3 hours to recharge the battery in EV and also varies with the battery capacity. It is the main point that is affecting the EVs from usage. The problem is solved in reference [5] by introducing a new mechanism in which the system charges the battery system automatically.

Probably by 2030, all internal combustion engine vehicles may be substituted by electric vehicles in recent times, DC solar-based several electric vehicles manufactured and examined [6]. Solar panels present on the vehicle cause the problem of where to store the energy from solar panels. So an analysis needs to be done on electrical energy storage systems [7]. The EVs nickel-metal hydride battery packs can be

approximated by a control algorithm [8]. A high-frequency AC-DC converter incorporated with an electromagnetic interference filter is employed for the charging of traction battery packs [9].

A large number of researches have been done for the improvement of PV system efficiency, different approaches are employed for the tracking of maximum power point from PV module for solving the efficiency problems and many products with these procedures are available in market for consumers [10], [11]. Solar power is the most efficient and practical alternative source of renewable energy [12], [13]. The SPEVs are far away from physical world feasibility because of their cost, energy shortcomings, and low power density [14]. In EVs and PHEVs, the batteries are usually made of many battery cells which are connected either in series or in parallel. Different operating conditions and variations caused during manufacturing imbalances reduce usable energy [15]–[19]

This research paper represents the design of a solar-powered electric vehicle (SPEV) and its working is simulated using MATLAB. Solar panels with maximum power point tracker (MPPT) are used for withdrawing the maximum possible power from solar panels under various situations. The output power from solar panels is fed to the buck-boost converter which increases the voltage to a specified value for charging of battery through the charge controller. Based on the condition of the battery, charging is finished for avoiding overcharging and deep discharge. Three-phase voltage source inverter (VSI) is used to feed power to brushless direct current (BLDC) motor for vehicle applications. Simulation results of this model are also examined.

2. RESEARCH METHOD

This paper deals with the charging of electric vehicles using renewable energy. The workflow diagram of the presented methodology explains about working of SPEV. Figure 1 depicts various steps involved in the proposed methodology.

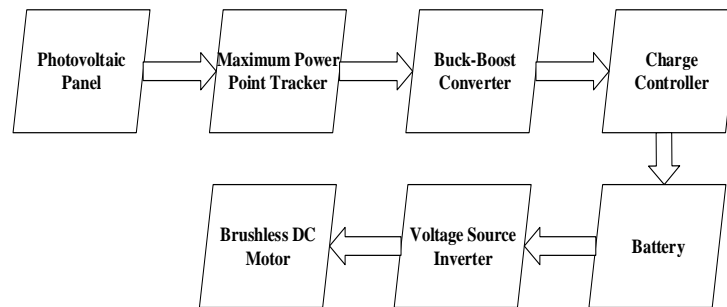

Figure 1. Workflow diagram of the proposed methodology

2.1. Solar cell

The solar cell is commonly known as a photovoltaic (PV) cell. It is an electrical component that transforms solar radiation into electrical power by the PV effect, a combination of both chemical and physical phenomenon. Its characteristics like current and voltage will get affected when exposed to solar radiation. The building blocks of PV modules are also known as solar panels. A PV panel is a combination of numerous solar cells attached in both series and parallel. One photovoltaic cell can be designed using a source, a diode, and two resistors as shown in Figure 2 [20], [21]. For mathematical modeling of the photovoltaic cell, the basic equation is derived from the commensurate circuit of the photovoltaic cell shown in Figure 2 [22]–[24].

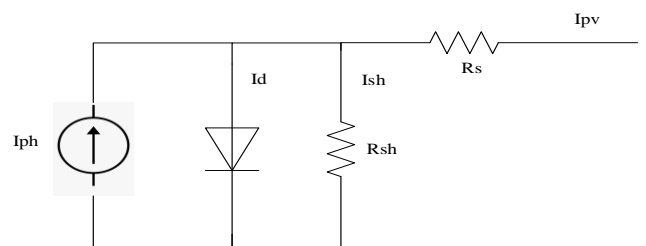

Figure 2. Equivalent circuit of the solar cell

The current generated from the solar cell can be given by (1) [25]–[27].

$$I_{pv} = I_{sh} - I_d = I_{sh} - I_o \left(e^{Q \left(\frac{V+I R_s}{akT_c} \right)} - 1 \right) \tag{1}$$

Where V is voltage inflicted across the cell, Q is the charge of an electron, A is the idealizing aspect, T_c is the temperature of the cell, K is the Boltzmann’s constant, and I_o is dark saturation current. Short circuit current (I_{sc}) is generated when the voltage across the cell zero and is the highest generated current during a short circuit. Its mathematical equation is given by (2) [28].

$$V_{open\ circuit} = V_t \ln \left(\frac{I_{sh}}{I_o} \right) \tag{2}$$

Where $V_t = \frac{akT_c}{Q}$. Figure 3 shows a PV module simulation in which a constant irradiance of 1000 W/m² is fed to the solar cell using a PS constant block. The output power, voltage, current data from the solar cell is exported to the workspace using the “To Workspace” block, and I-V, P-V characteristics are plotted.

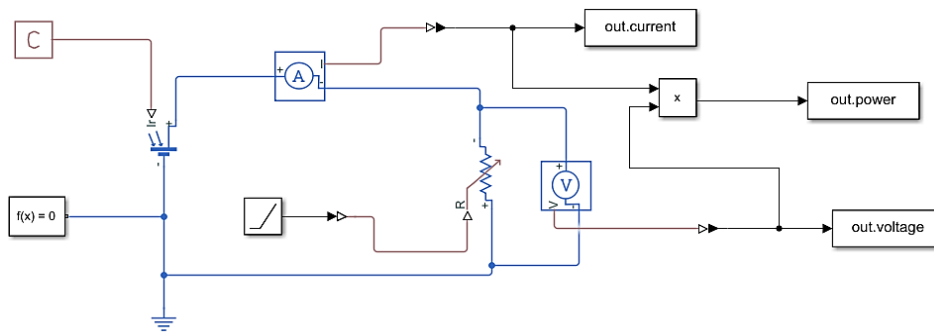

Figure 3. Simulation of PV module

2.2. Maximum power point tracking (MPPT)

MPPT is a device that tracks the maximum power from the PV module and switches it into voltage and provides maximum current for the battery to charge. For present MPPT’s, conversion is 93-93% efficient. The usual power gain we get in summer is 10-15% whereas, we get 20 to 45% power gain during winter. However, the actual power gain depends on many factors like heat and the state of charge of the battery. So, a P&O algorithm is used in MPPT to get the highest power from PV panels for running the load. Figure 4 shows the P&O algorithm of MPPT. The P&O works on the principle of changing the voltage levels by comparing the previous power with recent power.

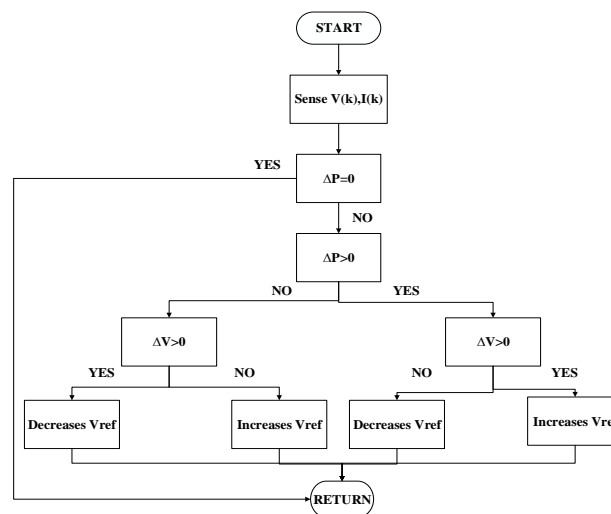

Figure 4. MPPT algorithm

2.3. Buck-boost converter

A buck-boost converter is well defined as a DC-DC converter that transforms the input DC voltage by enhancing or diminishing it. The amplitude of the output voltage from this converter depends on the factor, the duty cycle [29], [30]. It can be initiated in either the continuous or the discontinuous conduction mode. In the former conduction mode, the current coursing within the inductor tolerably emancipates but does not reach zero before the commencement of the switching cycle. On the other hand, In the latter conduction mode, the current within the inductor becomes zero. When the circuit is triggered, the current starts flowing from the input source to the inductor and load [31], [32]. While the circuit is turned off, the inductor skims current through the diode to load continuously. The capacitor at the output end reduces the ripples in output. Figure 5 shows the circuit diagram of the buck-boost converter. A voltage source is given as input to the circuit. MOSFET acts as one switch and diode acts as another switch. The diode is connected in opposite to the power flow direction from the input source and capacitor and the load is connected in parallel.

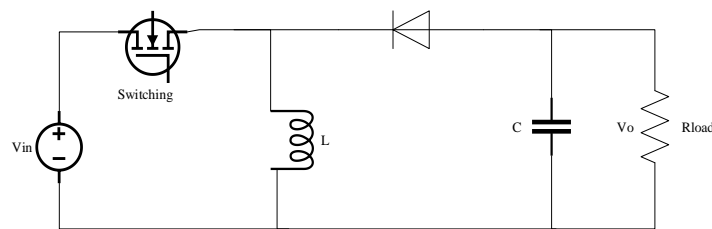

Figure 5. Buck-boost converter

2.4. Charge controller

It is a device that helps us to protect the battery from getting overcharged. The charge controller uses switched series regulator for PV applications to control the charging current. PWM is the most commonly used control method. With the same frequency but with differ in duty ratio power supply is given to the battery [33]. This method is the same as buck converter but the difference is here it is a PV Power source whose current is little. The control algorithm depends upon the battery type used and most of the charge controllers provide numerous settings to accommodate different voltages.

2.5. Battery

The batteries that are used in SPEVs are different from the other batteries like SLI batteries. The batteries in SPEV are designed to provide more power for a longer period to the electric system of the vehicle. SPEVs battery is the union of many battery cells connected in series and parallel. Each battery cell is made of different anode and cathode materials.

2.6. Voltage source inverter (VSI)

The circuit produces an AC voltage from a DC voltage source. The DC voltage is fed to the inverter. For the simulation of voltage source inverter (VSI), insulated gate bipolar transistors (IGBTs) with individual pulse generators are used. To limit the higher-order harmonics LC filter is used with the inductance of value 1.4 H and capacitance of value 50 μ F.

2.7. Brushless DC motor

This motor converts supplied electrical into mechanical energy. There are distant types of motors which are can be used, but among those, BLDC has high efficiency and easy to control, less weight, simple construction, and can also be used in various applications. The BLDC motor has the advantage of power-saving when compared to other motors. In this motor, the magnetic fields of the rotor and stator are with related frequency. BLDC motors have more lifetime and efficiency as this motor has no brushes. It also has more starting torque and fewer losses. Three-phase BLDC motors are more widely used in electric vehicles.

3. RESULTS AND DISCUSSION

In this research paper, the simulations have been performed using MATLAB. Figure 6 (a) depicts the I-V characteristics of the single photovoltaic cell and Figure 6 (b) depicts the P-V characteristics of the single photovoltaic cell. A temperature of 25 $^{\circ}$ C and irradiance of 1000 W/m² are recorded while the characteristics were obtained. The output of photovoltaic cells decreases with the change in intensity of light incident on the solar cell and it also changes with an increase in solar cells which causes a change of solar cell parameters.

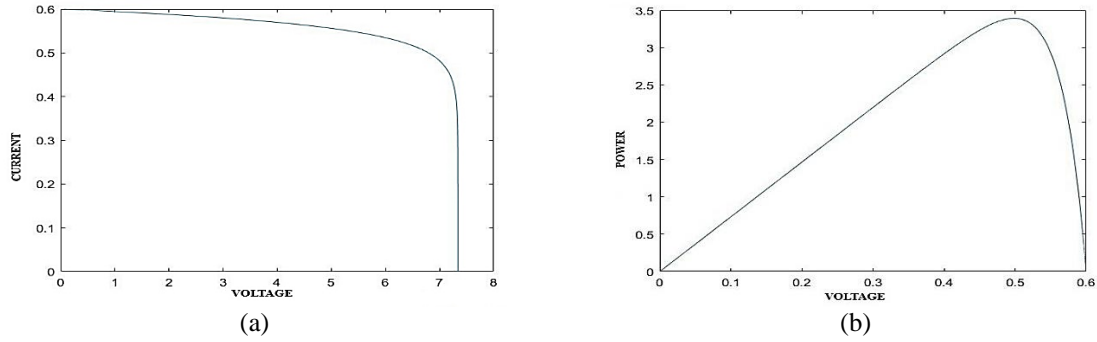

Figure 6. Characteristics of the solar cell for (a) I-V and (b) PV

Figure 7 shows the output of 3 phase VSI which is sinusoidal by using L-filter. Generally, the output of VSI is of square shape which is full of harmonics. If it is fed to the BLDC motor it leads to damage to the motor. So, LC filter is required to limit the harmonics and get a sinusoidal output. Figure 8 shows the current and voltage outputs of the Photovoltaic module in which the irradianations are changed from 0 to 1000 for various time instances and at a temperature of 25 °C. The output voltage from the PV panel is above 60 V which is boosted by a buck-boost converter to feed the battery for charging. Figure 9 shows the voltage and current output waveforms of the buck-boost converter whose input is given from a PV array for various irradianations and at a constant temperature of 25 °C. One can observe the output voltage coming out of the buck-boost converter is approximately 120 V which is almost double the output voltage of the Photovoltaic module which means here the buck-boost converter acted as a boost circuit.

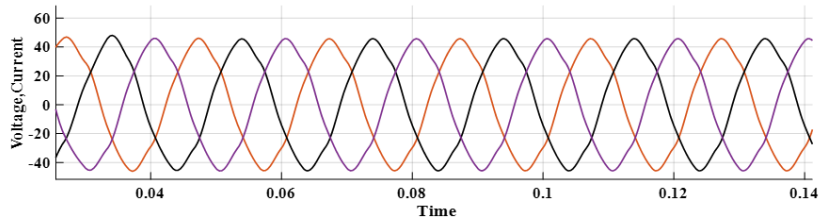

Figure 7. The output waveform of 3 phase VSI

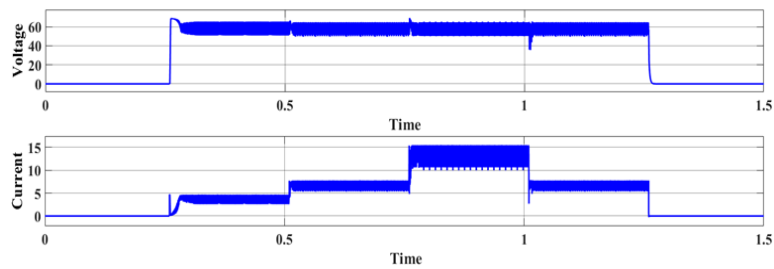

Figure 8. The output of the PV panel

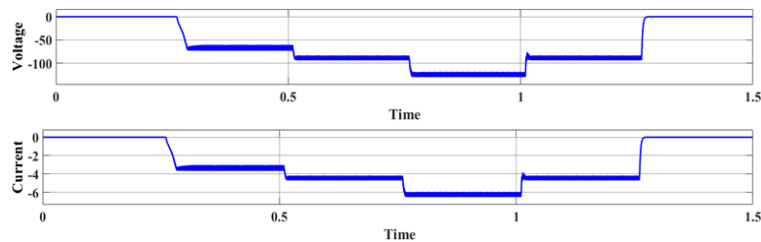

Figure 9. The output of the buck-boost converter

From Figure 10, it is detrimental that the maximum ideal power output for various irradianations from 0 to 1000 W/m² is above 800 W which is almost the same output power from the photovoltaic panel. When compared to ideal output power, the output power of the PV panel has a ripple that can be mitigated by using a suitable capacitor at the output. From Figure 11, it can be observed that efficiency of more than 95% is obtained. Here, the mean efficiency is calculated between the ideal output power and the output power of the PV panel.

From the results, one can observe that when the PV panel with MPPT is irradiated for various irradianations from 0 W/m² to 1000 W/m² and at a temperature of 25 °C, the output voltage obtained is about 60 V and power more than 800 W. The output voltage of 60 V is then boosted using the buck-boost converter to a voltage of 120 V which acted as a boost circuit. This voltage is fed to the battery through a charge controller. The 3 phase VSI produces an AC voltage from the battery which is fed to the BLDC motor. The overall mean efficiency achieved is 95%.

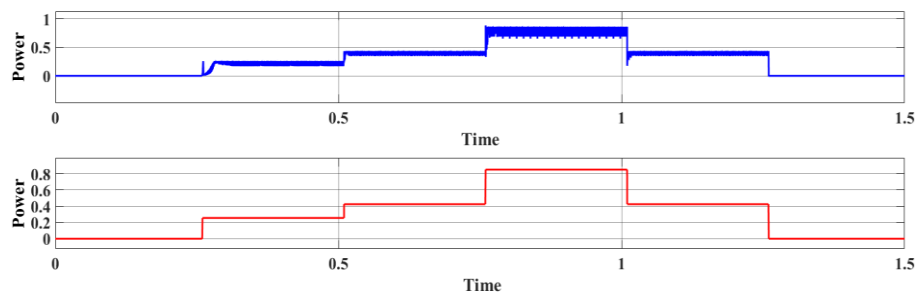

Figure 10. The power output of the PV panel

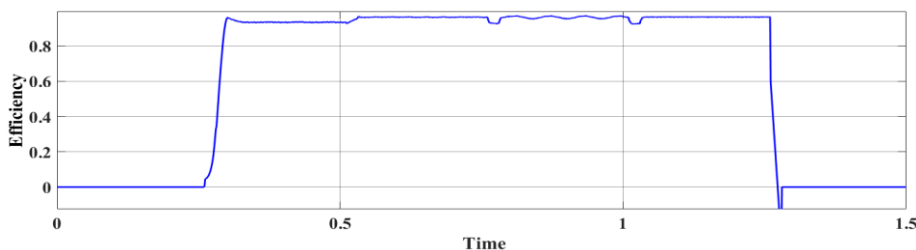

Figure 11. Mean efficiency

4. CONCLUSION

This paper represents the usage of renewable energy resources for the reduction of the effect of greenhouse gases on the environment caused by combustion engines. PV panels are used for the generation of electricity in solar-powered electric vehicles (SPEVs). Completely depending on solar power also have some disadvantages like limited range, high initial cost. But these can be avoided by conducting further research in this area and also by using ultra-efficient solar cells which give 30-35% efficiency. SPEVs will be more functional in the future.

ACKNOWLEDGEMENTS



This research work was funded by “Woosong University’s Academic Research Funding - 2022”.

REFERENCES



- [1] S. Manivannan and E. Kaleeswaran, “Solar powered electric vehicle,” *First International Conference on Sustainable Green Buildings and Communities (SGBC)*, pp. 1-4, Dec. 2016, doi: 10.1109/SGBC.2016.7936074.
- [2] G. Carli and S. S. Williamson, “Technical Considerations on Power Conversion for Electric and Plug-in Hybrid Electric Vehicle Battery Charging in Photovoltaic Installations,” *IEEE Transactions on Power Electronics*, vol. 28, no. 12, pp. 5784-5792, Dec. 2013, doi: 10.1109/TPEL.2013.2260562.
- [3] J. Qian and Z. Zhong, “Simulation analysis for steering mechanism of solar-powered electric vehicle,” *International Conference of Information Science And Management Engineering (ISME)*, pp. 262-26, Aug. 2010, doi: 10.1109/ISME.2010.206.

- [4] C. Chellaiyah, T. S. Balaji, and C. Mukuntharaj, "Design of a Fuel Free Electric Vehicle Using Fuzzy Logic for Pollution Control," *Procedia Engineering*, vol. 38, pp. 1547-1558, 2012, doi: 10.1016/j.proeng.2012.06.190.
- [5] M. Tariq, S. Bhardwaj, and M. Rashid, "Effective battery charging system by solar energy using C programming and microcontroller," *American journal of electrical power and energy systems*, vol. 2, no. 2, pp. 41-43, Mar. 2013, doi: 10.11648/j.epes.20130202.12.
- [6] T. L. Gibson and N. A. Kelly, "Solar photovoltaic charging of lithium-ion batteries," *Journal of Power Sources*, vol. 195, no. 12, pp. 3928-3932, Jun. 2010, doi: 10.1016/j.jpowsour.2009.12.082.
- [7] M. H. Au, J. K. Liu, J. Fang, Z. L. Jiang, W. Susilo, and J. Zhou, "A new payment system for enhancing location privacy of electric vehicles," *IEEE transaction Vehicle Technology*, vol. 63, pp. 3-18, 2014, doi: 10.1109/TVT.2013.2274288.
- [8] M. Pahlevaninezhad, D. Hamza, and P. K. Jain, "An improved layout strategy for common-mode EMI suppression applicable to high-frequency planar transformers in high-power DC/DC converters used for electric vehicles," *IEEE Transactions on Power Electronics*, vol. 29, no. 3, pp. 1211-1228, 2014, doi: 10.1109/TPEL.2013.2260176.
- [9] S. Roy, V. K. Singh, and D. P. Mishra, "Sun's Position Tracking by Solar Angles Using MATLAB," *International Conference on Renewable Energy Integration into Smart Grids: A Multidisciplinary Approach to Technology Modelling and Simulation (ICREISG)*, 2020, pp. 5-9, doi: 10.1109/ICREISG49226.2020.9174533.
- [10] D. P. Mishra, S. Chakraborty, and T. K. Tripathy, "Voltage Regulation of PV Cell using PID Controller," *International Conference on Recent Innovations in Electrical, Electronics & Communication Engineering (ICRIEECE)*, 2018, pp. 206-211, doi: 10.1109/ICRIEECE44171.2018.9008536.
- [11] B. Pakkiraiah and G. D. Sukumar, "Research Survey on Various MPPT Performance Issues to Improve the Solar PV System Efficiency," *Journal of Solar Energy*, vol. 2016, doi: 10.1155/2016/8012432.
- [12] H. Wei, Y. Zhong, L. Fan, Q. Ai, W. Zhao, R. Jing, and Y. Zhang, "Design and validation of a battery management system for solar-assisted electric vehicles," *Journal of Power Sources*, vol. 513, 2021, doi: 10.1016/j.jpowsour.2021.230531.
- [13] M. A. Spina *et al.*, "Some Issues on the Design of a Solar Vehicle Based on Hybrid Energy System," *International Journal of Energy Engineering*, vol. 2, no. 1, pp. 15-21, 2012, doi: 10.5923/j.ijee.20120201.03.
- [14] X. Hu, C. Zou, C. Zhang, and Y. Li, "Technological Developments in Batteries: A Survey of Principal Roles, Types, and Management Needs," *IEEE Power and Energy Magazine*, vol. 15, no. 5, pp. 20-31, Sept.-Oct. 2017, doi: 10.1109/MPE.2017.2708812.
- [15] M. Caspar, T. Eiler, and S. Hohmann, "Comparison of active battery balancing systems," *Proc. IEEE Vehicle Power Propuls. Conf. (VPPC)*, pp. 1-8, Oct. 2014, doi: 10.1109/VPPC.2014.7007027.
- [16] J. Cao, N. Schofield, and A. Emadi, "Battery balancing methods: A comprehensive review," *Proc. IEEE Vehicle Power Propuls. Conf. (VPPC)*, pp. 1-6, Sep. 2008, doi: 10.1109/VPPC.2008.4677669.
- [17] W. C. Lee, D. Drury, and P. Mellor, "Comparison of passive cell balancing and active cell balancing for automotive batteries," *Proc. IEEE Vehicle Power Propuls. Conf. (VPPC)*, pp. 1-7, Sep. 2011, doi: 10.1109/VPPC.2011.6043108.
- [18] W. Han, L. Zhang, and Y. Han, "Computationally efficient methods for state of charge approximation and performance measure calculation in series-connected battery equalization systems," *Journal of Power Sources*, vol. 286, pp. 145-158, Jul. 2015, doi: 10.1016/j.jpowsour.2015.03.123.
- [19] G. J. Osório *et al.*, "Rooftop photovoltaic parking lots to support electric vehicles charging: A comprehensive survey," *International Journal of Electrical Power & Energy Systems*, vol. 133, 2021, doi: 10.1016/j.ijepes.2021.107274.
- [20] T. Shimizu, M. Hirakata, T. Kamezawa, and H. Watanabe, "Generation control circuit for photovoltaic modules," *IEEE Transactions on Power Electronics*, vol. 16, no. 3, pp. 293-300, May 2001, doi: 10.1109/63.923760.
- [21] V. Sandeep, S. Shastri, A. Sarkar, and S. R. Salkuti, "Modeling of battery pack sizing for electric vehicles," *International Journal of Power Electronics and Drive System (IJPEDS)*, vol. 11, No. 4, pp. 1987-1994, Dec. 2020, doi: 10.11591/ijped.v11.i4.pp1987-1994.
- [22] T. Salmi, M. Bouzguenda, A. Gastli, and A. Masmoudi, "MATLAB/Simulink Based Modelling of Solar Photovoltaic Cell," *International Journal of Renewable Energy Research*, vol. 2, no. 2, pp. 213-218, 2012.
- [23] M. G. Villalva, J. R. Gazoli, and E. R. Filho, "Modeling and circuit-based simulation of photovoltaic arrays," *Brazilian Power Electronics Conference*, 2009, pp. 1244-1254, doi: 10.1109/COBEP.2009.5347680.
- [24] S. R. Salkuti, "Energy Storage and Electric Vehicles: Technology, Operation, Challenges, and Cost-Benefit Analysis," *International Journal of Advanced Computer Science and Applications*, vol. 12, no. 4, pp. 40-45, 2021, doi: 10.14569/IJACSA.2021.0120406.
- [25] M. G. Villalva, J. R. Gazoli, and E. R. Filho, "Comprehensive approach to modelling and simulation of photovoltaic arrays," *IEEE Transaction on Power Electronics*, vol. 24, no. 5, pp. 1198-1208, 2009, doi: 10.1109/TPEL.2009.2013862.
- [26] K. Keshavani, J. Joshi, V. Trivedi, and M. Bhavsar, "Modelling and Simulation of Photovoltaic Array using Matlab/Simulink," *International Journal of Engineering Development and Research*, vol. 2, no. 4, pp. 3742-3751, 2014.
- [27] S. Rustemli and F. Dincer, "Modeling of Photovoltaic Panel and Examining Effects of Temperature in Matlab/Simulink," *Electronics and Electrical Engineering*, vol. 109, no. 3, pp. 35-40, 2011.
- [28] S. R. Salkuti, "Optimal Operation of Microgrid considering Renewable Energy Sources, Electric Vehicles and Demand Response," *E3S Web of Conferences*, vol. 87, pp. 1-6, Mar. 2019, doi: 10.1051/e3sconf/20198701007.
- [29] S. Nema, R. K. Nema, and G. Agnihotri, "MATLAB/Simulink based study of photovoltaic cells/modules/array and their experimental verification," *International journal of Energy and Environment*, vol. 1, no. 3, pp. 487-500, 2010.
- [30] A. R. Bhatti, Z. Salam, M. J. B. A. Aziz, K. P. Yee, and R. H. Ashique, "Electric vehicles charging using photovoltaic: Status and technological review," *Renewable and Sustainable Energy Reviews*, vol. 54, pp. 34-47, 2016, doi: 10.1016/j.rser.2015.09.091.
- [31] M. Rashid, *Power Electronics: Circuits, Devices & Applications*, 4th Edition, Pearson Education, pp. 166-225, 2004.
- [32] S. S. Reddy, "Optimal Scheduling of Thermal-Wind-Solar Power System with Storage," *Renewable Energy*, vol. 101, pp. 1357-1368, Feb. 2017, doi: 10.1016/j.renene.2016.10.022.
- [33] D. M. Bellur and M. K. Kazimierzuk, "DC-DC converters for electric vehicle applications," *Electrical Insulation Conference and Electrical Manufacturing Expo*, 2007, pp. 286-293, doi: 10.1109/EEIC.2007.4562633.



BIOGRAPHIES OF AUTHORS

Mandakuriti Nivas    is pursuing Bachelor of Technology (B.Tech) in the stream of Electrical and Electronics Engineering in International Institute of Information Technology Bhubaneswar (IIIT-BH), Odisha, India. His research interests include renewable energy, power quality, electric vehicles and Artificial Intelligence. He can be contacted by email: mnivas345@gmail.com.





Rambilli Krishna Prasad Rao Naidu    is pursuing Bachelor of Technology (B.Tech) in the stream of Electrical and Electronics Engineering in International Institute of Information Technology Bhubaneswar (IIIT-BH), Odisha, India. His research interests include renewable energy, power electronics, electric vehicles and power grid. He can be contacted by email: krishnaprasadraonaidu@gmail.com.



Debani Prasad Mishra    received the B.Tech. in electrical engineering from the Biju Patnaik University of Technology, Odisha, India, in 2006 and the M.Tech in power systems from IIT, Delhi, India in 2010. He has been awarded the Ph.D. degree in power systems from Veer Surendra Sai University of Technology, Odisha, India, in 2019. He is currently serving as Assistant Professor in the Dept of Electrical Engg, International Institute of Information Technology Bhubaneswar, Odisha. He has 11 years of teaching experience and 2 years of industry experience in the thermal power plant. He is the author of more than 80 research articles. His research interests include soft Computing techniques application in power system, signal processing and power quality. 3 students have been awarded Ph.D under his guidance and currently 4 Ph.D. Scholars are continuing under him. He can be contacted at email: debani@iiit-bh.ac.in.



Surender Reddy Salkuti    received the Ph.D. degree in electrical engineering from the Indian Institute of Technology, New Delhi, India, in 2013. He was a Postdoctoral Researcher with Howard University, Washington, DC, USA, from 2013 to 2014. He is currently an Associate Professor with the Department of Railroad and Electrical Engineering, Woosong University, Daejeon, South Korea. His current research interests include power system restructuring issues, ancillary service pricing, real and reactive power pricing, congestion management, and market clearing, including renewable energy sources, demand response, smart grid development with integration of wind and solar photovoltaic energy sources, artificial intelligence applications in power systems, and power system analysis and optimization. He can be contacted at email: surender@wsu.ac.kr.