

MAQUET

**SERVO-s Ventilator System  
Service Manual**

CRITICAL CARE





## Contents

<b>1. Important .....</b>	<b>1</b>
<b>2. Introduction .....</b>	<b>2</b>
<b>3. Description of functions .....</b>	<b>3</b>
<b>4. Disassembling and assembling .....</b>	<b>4</b>
<b>5. Service procedures .....</b>	<b>5</b>
<b>6. Troubleshooting .....</b>	<b>6</b>
<b>7. Preventive maintenance .....</b>	<b>7</b>
<b>8. Index .....</b>	<b>8</b>
<b>9. Service Manual revision history .....</b>	<b>9</b>
<b>10. Diagrams .....</b>	<b>10</b>

# Important





## General

- Service documentation for the SERVO-s Ventilator System consists of:
  - User's Manual. The User's Manual is an indispensable complement to the Service Manual for proper servicing.
  - Service Manual
  - Installation Instructions
  - Spare Parts information
  - Documentation for all optional equipment included in the SERVO-s System is also available.
- The SERVO-s Ventilator System is referred to as the **SERVO-s** throughout this manual.
- There are two serial number labels on the unit:
  - One label is attached to the Patient Unit close to the supply gas inlets. The serial number stated on this label is the ID number of the Patient Unit. The serial number is also stored in the SW memory as the 'System ID'.
  - One label is attached to the rear side of the User Interface close to the On/Off switch. The serial number stated on this label is the ID number of the User Interface.
- System version number can be found in the Status window on the User Interface. Make sure that the version of the User's Manual corresponds to the System version.

Text inside a box is used to highlight important information.

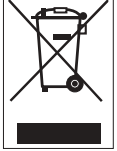
- In addition to the Important information given here and in the related documents (e. g. in the User's manual), always pay attention to applicable local and national regulations.
- Responsibility for the safe functioning of the equipment reverts to the owner or user in all cases in which service or repair has been done by a non-professional or by persons who are not employed by or authorized by MAQUET, and when the equipment is used for other than its intended purpose.

## Symbols used in this manual

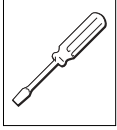
- **ESD sensitive components.** When handling ESD-sensitive devices, established procedures must be observed to prevent damage. 
- **Special waste.** This product contains electronic and electrical components. Discard disposable, replaced and left-over parts in accordance with appropriate industrial and environmental standards. 
- **Recycling.** Worn-out batteries must be recycled or disposed of properly in accordance with appropriate industrial and environmental standards. 
- With power supply connected to the SERVO-s, there are energized electrical components inside the unit. Exercise extreme caution if power supply connected and covers are removed. 
- **Technical training.** Refers to the Technical training supplied by MAQUET. 
- **Service contract.** Refers to the Service contract supplied by MAQUET. 

## Installation

- Only personnel trained and authorized by MAQUET shall be permitted to install the SERVO-s. The installation and handing-over procedures are described in the 'SERVO-s Ventilator System – Installation Instructions'. 

## Functional check

- After any installation, maintenance or service intervention in the SERVO-s, perform a 'Pre-use check' according to instructions in the 'SERVO-s Ventilator System – User's Manual'.

## Important

### Service

- The SERVO-s must be serviced at regular intervals by personnel trained and authorized by MAQUET. Any maintenance or service must be noted in a log book provided.



- It is recommended that maintenance and service is done as a part of a service contract with MAQUET.

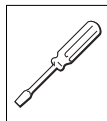

- For functionality enhancement, the latest released System SW version is always recommended.

- Preventive maintenance must be performed at least once every year as long as the unit is not used more than normal. Normal operation is estimated to correspond to approx. 5.000 hours of operation. Details are found in this Service Manual, chapter 'Preventive maintenance'.

- The Battery modules shall be replaced after two and a half years from their manufacturing date.

- The internal Lithium batteries (on PC 1771 and PC 1772) shall be replaced every five years.

- Worn-out batteries must be recycled or disposed of properly in accordance with appropriate industrial and environmental standards.



- This product contains electronic and electrical components. Discard disposable, replaced and left-over parts in accordance with appropriate industrial and environmental standards.



- When working with ESD sensitive components, always use a grounded wrist band and a grounded work surface. Adequate service tools must always be used.



### Hazard notices

- Before disassembling or assembling of the SERVO-s, make sure that the:
  - On/Off switch is set to Off.
  - Mains power cable is disconnected.
  - Gas supply is disconnected (wall and/or cylinder).
  - Regular cleaning and extended cleaning of the inspiratory channel are performed. Refer to instructions in the User's Manual.

- With power supply connected to the SERVO-s, there are energized electrical components inside the unit. All personnel must exercise extreme caution if fault tracing or adjustments are performed with power supply connected and with user interface and patient unit covers removed.

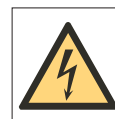

### To the responsible service personnel

- The contents of this document are not binding. If any significant difference is found between the product and this document, please contact MAQUET for further information.
- We reserve the right to modify products without amending this document or advising the user.
- Only personnel trained and authorized by MAQUET shall be permitted to perform installation, service or maintenance of the SERVO-s. Only MAQUET genuine spare parts must be used. PC boards (spare parts) must always be kept in a package for sensitive electronic devices. MAQUET will not otherwise assume responsibility for the materials used, the work performed or any possible consequences of same.
- The device complies to standards and requirements as stated in the 'SERVO-s Ventilator System – User's Manual'.



## Important

### Environmental declaration

#### Purpose

This environmental declaration is for a SERVO-s base unit.

Letters codes within brackets refers to the Functional Block Diagram in chapter Diagrams.

#### Components with special environmental concern

Components listed below shall be disposed of in accordance with appropriate industrial and environmental standards.

##### Printed circuit boards

- PC 1771 Control, including a Lithium battery (C)
- PC 1772 Monitoring, including Lithium battery (M)
- PC 1777 Panel including Backlight Inverter (U)
- PC 1781 Pressure transducer, 2 each (T)
- PC 1784 Expiratory channel (F)
- PC 1785 Expiratory channel connector (E)
- PC 1786 Expiratory channel cassette (E)
- PC 1860 Main back-plane
- PC 1861 Pneumatic back-plane (I)
- PC 1862 DC/DC & Standard connectors (P)
- PC 1863 Power control (P)

##### Other electronics

- TFT assembly including backlight (U)
- Touch screen (glass) (U)
- O<sub>2</sub> cell, containing caustic lime and lead (Pb) (I)
- O<sub>2</sub> Sensor, containing PC boards (I)
- Gas module Air, containing multiple PC boards (I)
- Gas module O<sub>2</sub>, containing multiple PC boards (I)
- AC/DC Converter, containing PC boards (P)
- Expiratory cassette (E)
- Expiratory valve coil (E)
- Safety valve pull magnet (I)
- Battery modules Nickel-Metal Hydride (P)

### Construction materials

The construction materials used in SERVO-s in % of the total weight.

#### Metal – total 72.5%

- Aluminium 70%
- Steel, zink, brass 2.5%

#### Polymeric material – total 8%

- PA (Polyamide)
- POM (Polyoxymethylene)
- SI (Silicone)
- TPE (Thermoplastic elastomer)
- PUR (Polyurethane)
- ABS (Acrylonitrilebutadienstyrene)
- EPDM (Ethylenpropylenedienemonomer)
- PTFE (Polytetrafluoroethylene)
- FPM (Fluororubber)
- NBR (Nitrilerubber)
- PP (Polypropylene)
- PVC (Polyvinyl chloride)
- PS (Polystyrene)

#### Electronics – total 19.5%

- Battery modules Nickel-Metal Hydride
- Printed circuit boards, cables etc.

#### Others – very small amounts

- Filter paper of fibre glass

## Important

### Articles of consumption

1. Bacteria filter
2. Filters for the gas modules
3. Filter for the inspiration pressure transducer
4. Filter for the O<sub>2</sub> cell (if applicable)
5. Nozzle units for the gas modules
6. Battery modules
7. Lithium batteries
8. Expiratory cassette
9. Expiratory cassette membrane
10. O<sub>2</sub> cell (if applicable)
11. Backlight lamps.

Item 1: Consumption approximately 250 pcs/year.

Items 2 – 5: Changed approx. every 5.000 hours.

Items 6: Changed approx. every 12.500 hours.

Items 7: Changed approx. every 25.000 hours.

Items 8 – 11: Changed when needed.

### Power consumption

The power consumption depends on the operating mode and whether the internal batteries are being fast or trickle charged.

Mode	Fast charging	Trickle charging
In operation	70 W	38 W
Standby	65 W	33 W
Off	35 W	6 W

### Noise level

Less than 50 dBA.

### Packing materials

The amounts of packing materials will vary depending on customer adaptation.

#### Materials for packing:

- Loading pallet. Fulfils the USA requirements 7 CFR 319.40 May 25'th 1995.
- Corrugated cardboard
- Shock-absorbing material of expanded polyethylene, EPE, or expanded polypropylene, EPP.

### Product End-of-Life

For scrapping information, refer to the document 'SERVO-s Ventilator System – Product End-of-Life Disassembly Instructions.





Only personnel trained and authorized by MAQUET shall be permitted to perform installation, service or maintenance of the SERVO-s.



Make sure to prepare the SERVO-s properly before disassembling and assembling. Refer to section 'Hazard notices' in chapter 'Important'.

Any service or maintenance must be noted in a log book.

After any installation, maintenance or service intervention in the SERVO-s, perform a 'Pre-use check'. Refer to the 'SERVO-s Ventilator System – User's Manual' for details.

This product contains electronic and electrical components. Discard disposable, replaced and left-over parts in accordance with appropriate industrial and environmental standards.



## 2. Introduction

Main units .....	2 - 2
User Interface .....	2 - 4
Patient Unit .....	2 - 6
SERVO-s software structure .....	2 - 9
General .....	2 - 9
Breathing .....	2 - 9
Monitoring .....	2 - 9
Panel .....	2 - 9
System ID .....	2 - 9

## Main units

The SERVO-s is configured for adults and pediatrics with a number of ventilation modes suitable for these patient categories.

The SERVO-s can be divided into the following main units:

**2**

- **User Interface.** The User Interface contains all controls used to set the ventilation and monitoring parameters. Ventilation parameters as well as other important information are shown on the User Interface display.
- **Patient Unit.** The Patient Unit contains pneumatics and electronics for gas supply to the patient. Power supply and battery back-up is also contained in the Patient Unit.

The Control cable connects the User Interface and the Patient Unit.

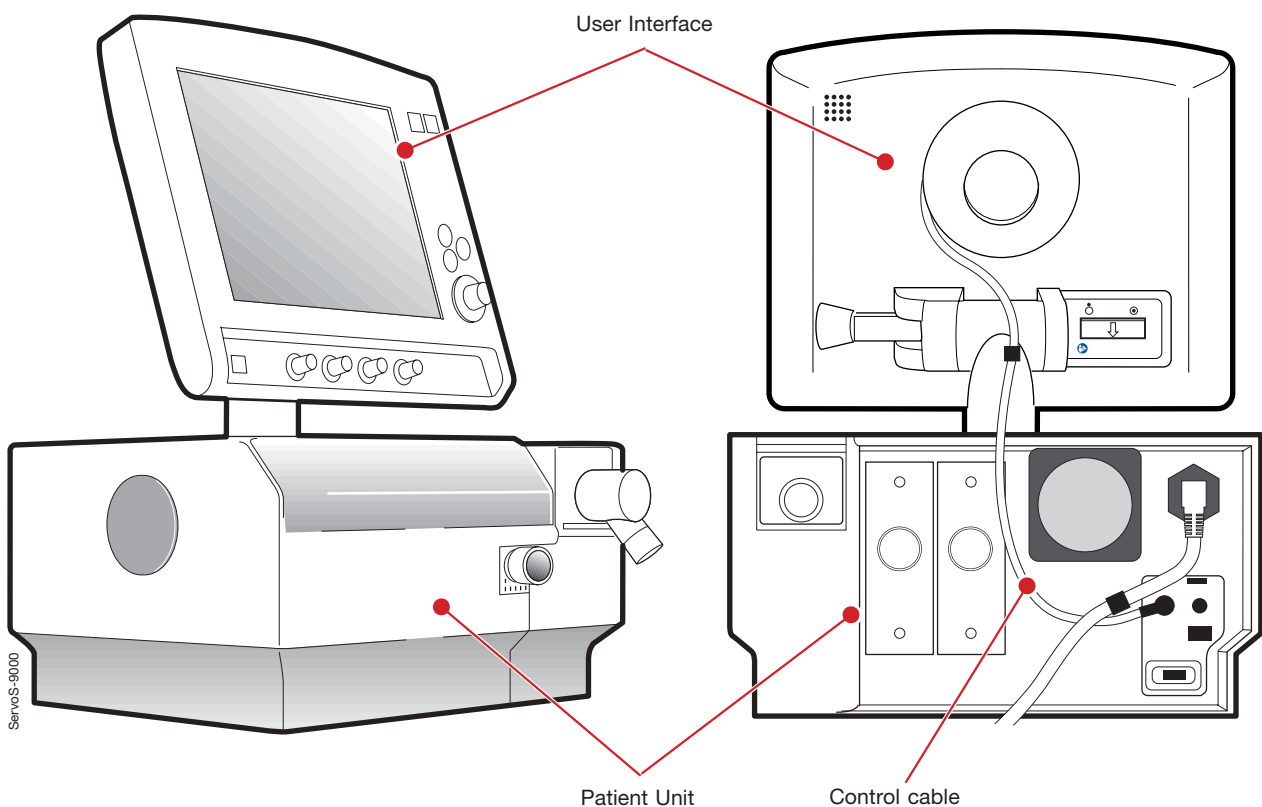

A number of optional equipment can be added to the SERVO-s Ventilator System. For further information, refer to the documents listed below.

**Mobile cart SERVO-s**

- SERVO-s – User's manual
- Mobile cart, SERVO-s – Installation Instructions

**Shelf base SERVO-s**

- SERVO-s – User's Manual
- Shelf base, SERVO-s – Installation Instructions

**Support Arm 176/177**

- SERVO-s – User's Manual
- Support Arm 176/177 – Installation Instructions

**Gas cylinder restrainer SERVO-s**

- SERVO-s – User's manual
- Gas cylinder restrainer, SERVO-s – Installation Instructions

**Aeroneb Pro**

- Aeroneb Pro – Instruction Manual
- Aeroneb Pro – Installation Instructions

**Compressor Mini**

- SERVO-s – User's Manual
- Compressor Mini – Operating Manual
- Compressor Mini – Service Manual
- Compressor Mini – Installation Instructions

**Alarm output connector**

- SERVO-s – User's Manual
- Alarm output connector – Reference Manual

**Humidifier, Humidifier Holder and Humidifier Holder for rail**

- SERVO-s – User's Manual
- Humidifier – Operating Manual
- Humidifier Holder – Installation Instructions

**Waterbag pole**

- Instructions mounted on the pole.

**User Interface panel cover**

- SERVO-s – User's Manual
- User Interface panel cover – Installation Instructions

**Loudspeaker booster kit**

- Loudspeaker booster kit – Installation Instructions

**Isolation shield with drip guard**

- Isolation shield with drip guard – Installation Instructions

2

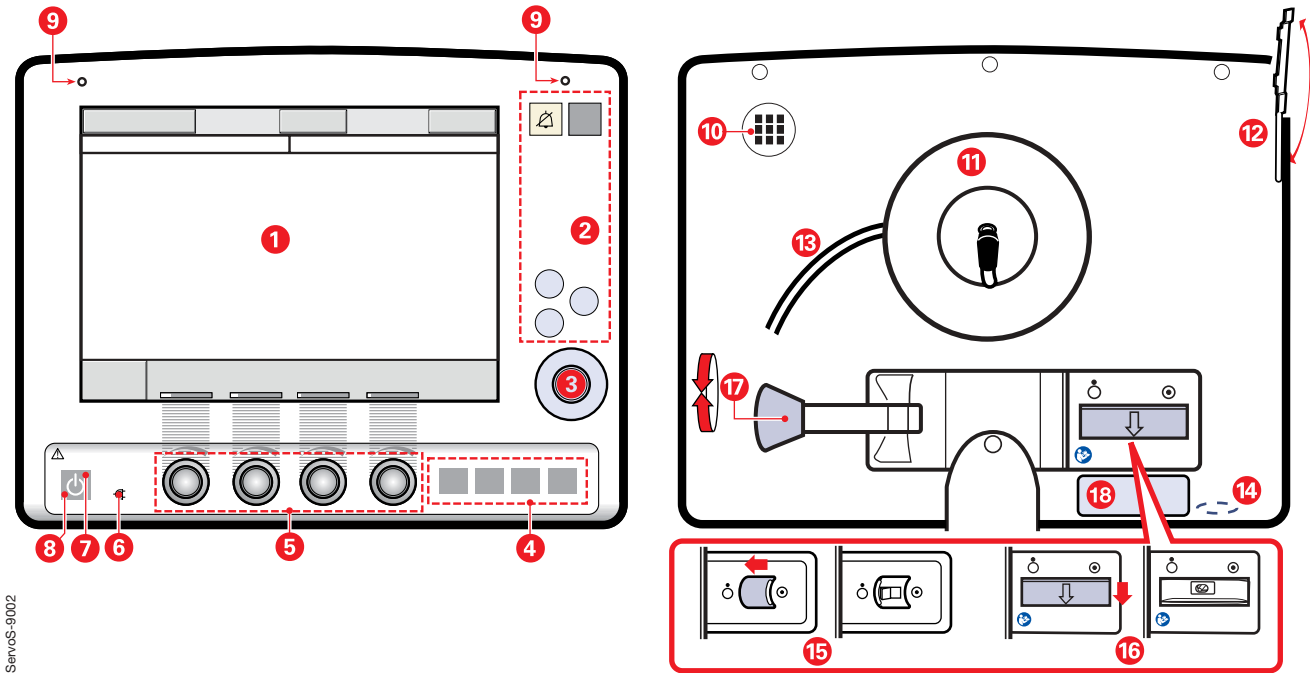

**User Interface**

Items accessible from the outside of the User Interface are shown in the above illustration.

- 1. Display with touch screen.
- 2. Fixed keys for immediate access to special windows.
- 3. Main rotary dial.
- 4. Special function keys.
- 5. Direct access knobs.
- 6. Mains indicator (green).
- 7. Standby indicator (yellow).
- 8. Start/Stop (Standby) ventilation key.
- 9. Luminescence detector, adjusts display brightness automatically. On User Interface of Type 1, the detector is placed in the upper left corner. On User Interface of Type 2, the detector is placed above the Fixed keys in the upper right corner.

- 10. Loudspeaker grid.
- 11. Cable reel.
- 12. PC card slot with slot cover.
- 13. Control cable between User Interface and Patient Unit.
- 14. Service connector, for PC.
- 15. On/Off switch and switch cover, version discontinued in production Q2 2007.
- 16. On/Off switch and switch cover, version introduced in production Q2 2007.
- 17. Locking arm, tilting.
- 18. Serial number label. The serial number stated on this label is the ID number of the User Interface. This serial number must always be referred to when ordering service, spare parts, etc for the User Interface.

For further information regarding operation of the User Interface, refer to the User's manual.

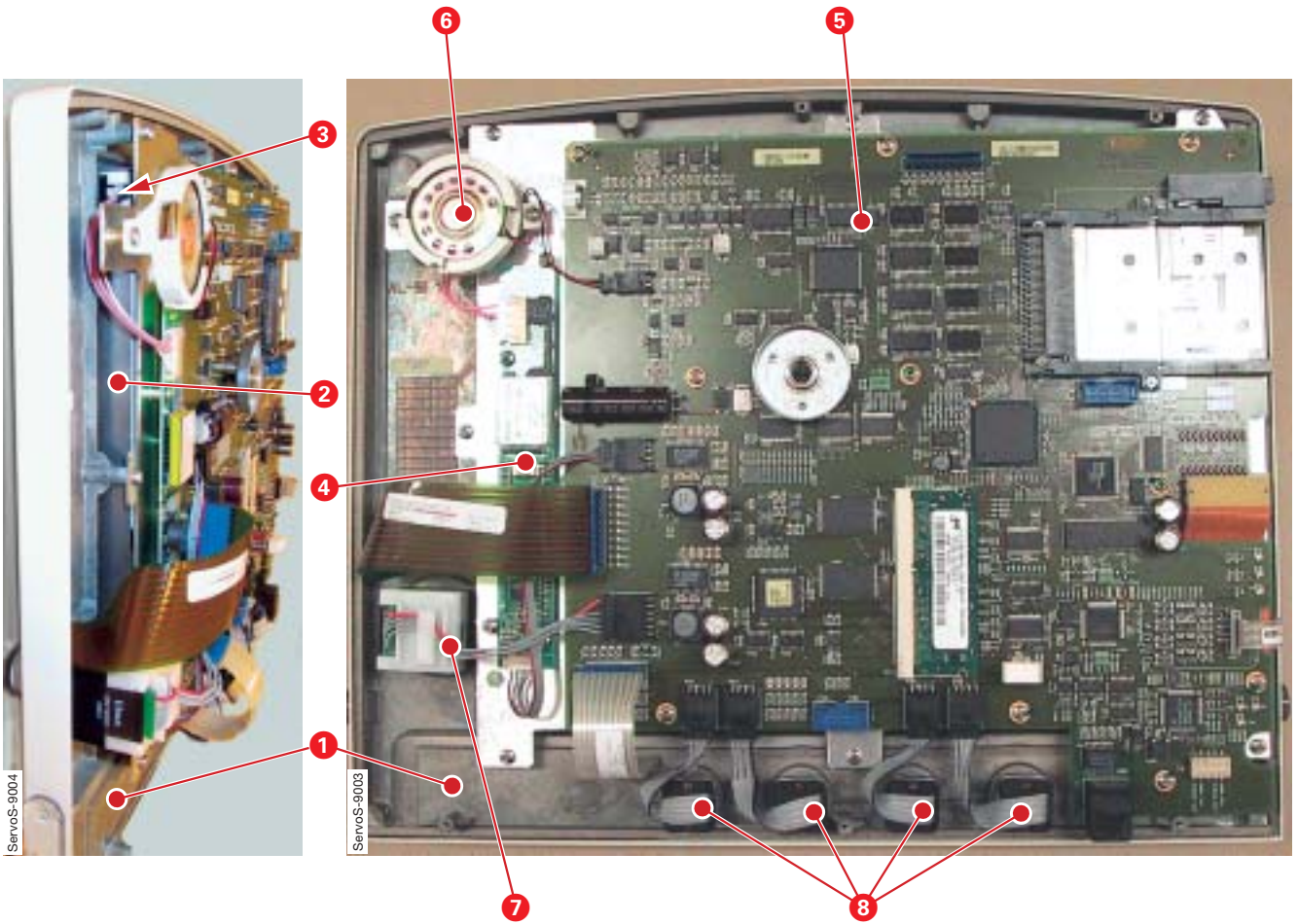

When the front panel section is removed from the rear cover, the following parts are accessible:

1. Touch screen incl. frame.
2. TFT Display.
3. Backlight lamp.
4. PC board Backlight inverter.
5. PC 1777 Panel including PC Card slot.
6. Loudspeaker.
7. Main rotary dial (rotary encoder with switch).
8. Direct access controls (rotary encoder).

The illustration above shows User Interface of Type 2.

2

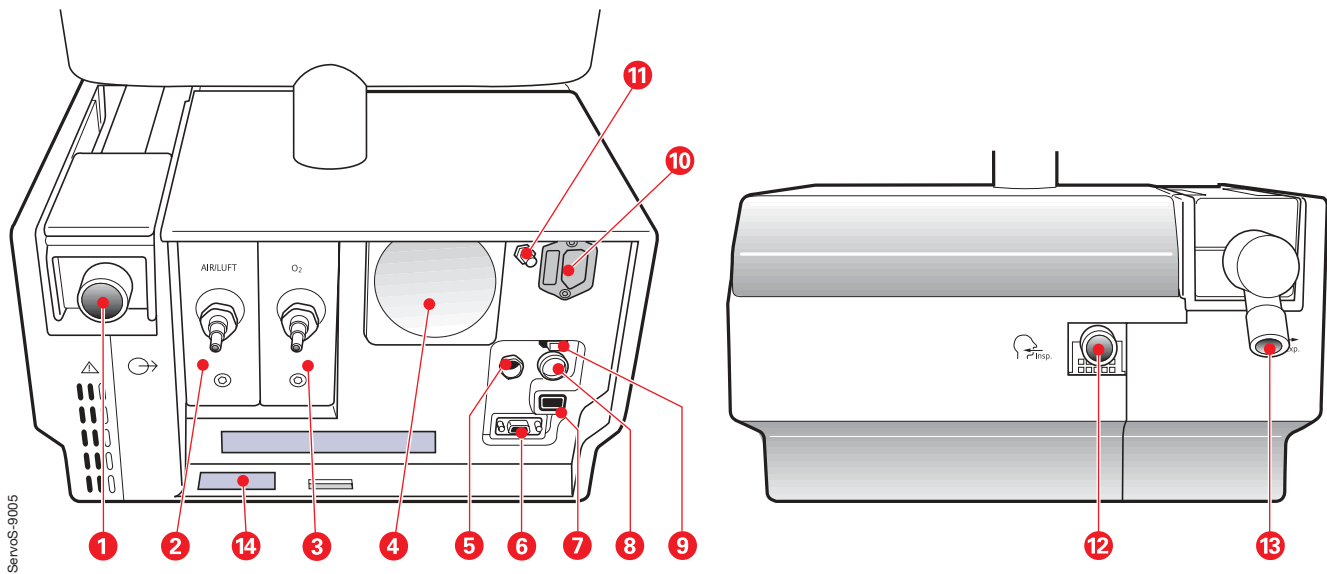

## Patient Unit

Items accessible from the outside of the Patient Unit are shown in the illustration above. All labels attached to the rear side of the Patient Unit are described in the User's Manual.

1. Expiratory outlet.
2. Gas module for Air.
3. Gas module for O<sub>2</sub>.
4. Internal fan with filter.
5. Control cable connector.
6. Serial port for data communication (RS 232).
7. Alarm output connector (optional).
8. Connector for external +12V DC power supply.
9. Fuse F1 for external +12V DC power supply.
10. Mains supply connector incl. fuses F11 and F12.
11. Equipotentiality terminal.
12. Inspiratory outlet.
13. Expiratory inlet.
14. Serial number label. The serial number stated on this label is the ID number of the Patient Unit. The serial number is also stored in the SW memory as the 'System ID'. This serial number must always be referred to when ordering service, spare parts, software updates/upgrades, etc.

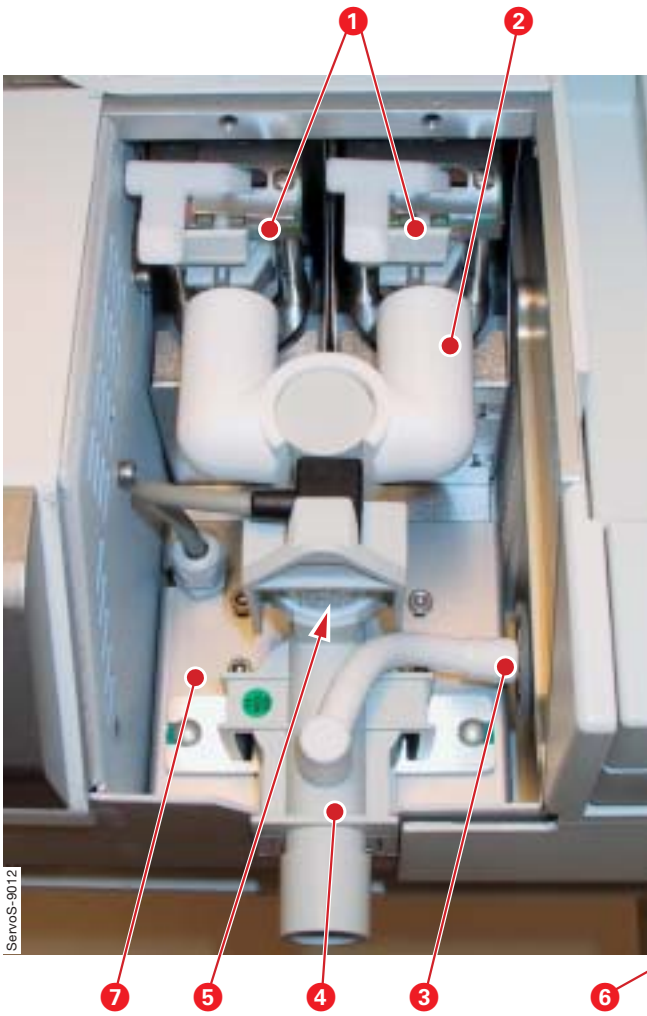

When the Patient Unit main cover is opened, the following parts are accessible:

1. The inner part of the two gas modules including their nozzle units.
2. Connector muff.
3. Inspiratory pressure transducer tube, incl. bacteria filter, to connect the inspiratory pressure transducer.
4. Inspiratory pipe with housings for the O<sub>2</sub> Sensor/cell and for the safety valve.
5. O<sub>2</sub> cell incl. bacteria filter.
6. O<sub>2</sub> Sensor. Alternative to the O<sub>2</sub> cell for oxygen concentration measurement.
7. PC 1861 Pneumatic back-plane (covered by the metal plate). The gas modules, the O<sub>2</sub> Sensor/cell and the safety valve pull magnet are connected to PC 1861.

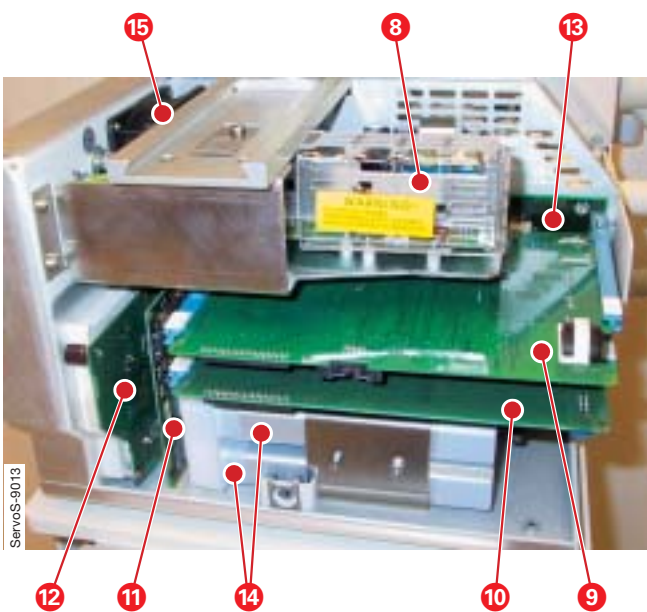
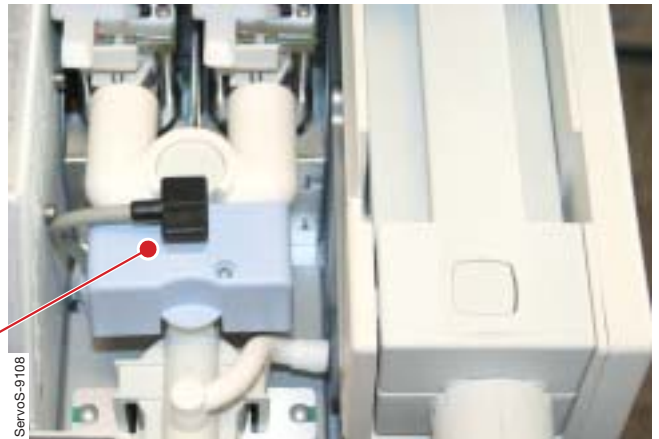

When the Patient Unit main cover is removed, the following parts are accessible:

8. AC/DC Converter.
9. PC 1772 Monitoring.
10. PC 1771 Control.
11. PC 1863 Power control.
12. PC 1862 DC/DC & Standard connectors.
13. PC 1860 Main back-plane. The PC boards listed above are connected to PC 1860 Main back-plane.
14. Battery modules.
15. Internal fan.

2

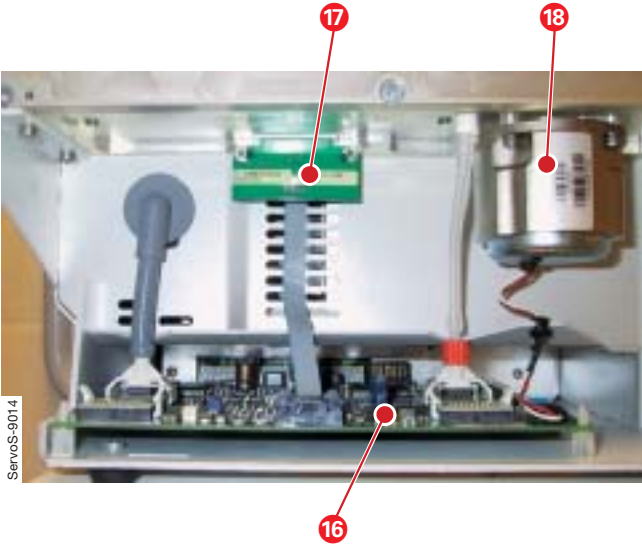

When the Patient Unit side cover is removed, the following parts are accessible:

- 16. PC 1784 Expiratory channel with the two connected PC 1781 Inspiratory and Expiratory Pressure Transducers.
- 17. PC 1785 Expiratory channel connector.
- 18. Expiratory valve coil.

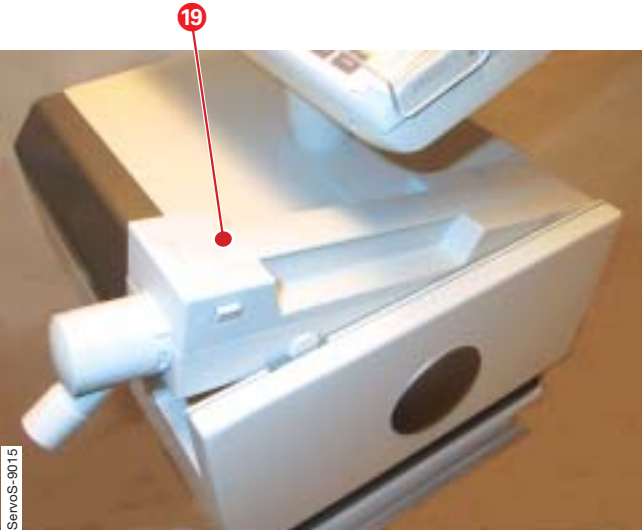

The expiratory cassette (19) is a complete unit. It contains the following parts:

- Expiratory inlet with moisture trap.
- PC 1786 Expiratory channel cassette.
- Ultrasonic flowmeter.
- Heating foil to keep a stable temperature in the expiratory gas.
- Pressure transducer connection, incl. bacteria filter, to connect the expiratory pressure transducer.
- Expiratory valve incl. valve membrane.
- Expiratory one-way valve.

The expiratory valve coil, mounted under the expiratory cassette compartment, controls the valve membrane in the cassette.

PC 1786 Expiratory channel cassette inside the expiratory cassette is electrically connected to PC 1784 Expiratory channel via PC 1785 Expiratory channel connector (17).

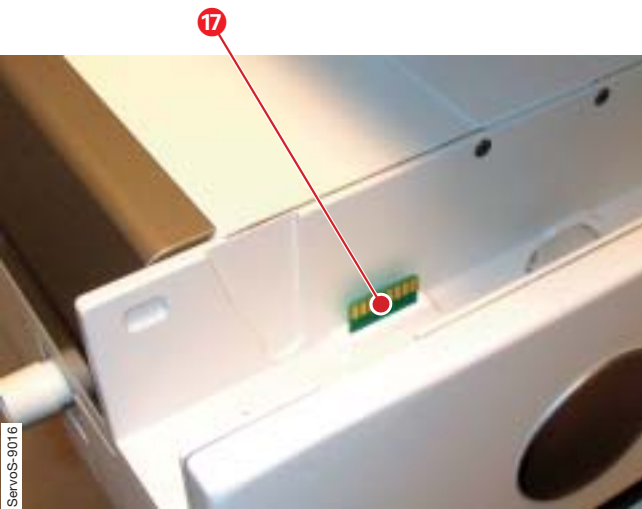



## SERVO-s software structure

### General

The SERVO-s software installed in the ventilator will contain all available system functionality. The software is separated into different subsystems and stored on some of the PC boards. The separation of the software is handled by the installation program.

The SERVO-s software is divided into the following software subsystems:

- Breathing
- Monitoring
- Panel
- System ID

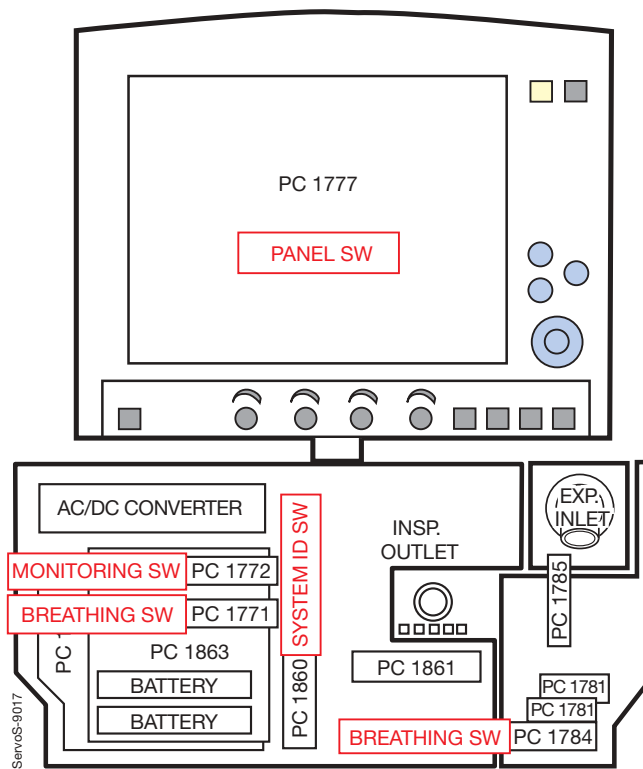

### Breathing

The Breathing SW controls the delivery of gases to the patient. This subsystem is responsible for the breathing system, that is:

- Ventilation control and regulation
- Inspiratory channel
- Expiratory channel

The Breathing SW is stored on PC 1771 Control and PC 1784 Expiratory Channel. The software must be re-installed if PC 1771 or PC 1784 is replaced. New software can be installed via a SW Service Release.

The Breathing SW is executed by microprocessors on PC 1771 and PC 1784.

### Monitoring

The Monitoring SW controls all monitoring and alarm functions in the system, including trends of measured values (trend data not available in SERVO-s v1.0). Events, such as alarms and change of settings will also be logged.

The Monitoring SW is stored on PC 1772 Monitoring. The software must be re-installed if PC 1772 is replaced. SW related to Monitoring is also stored in the O<sub>2</sub> Sensor. New software can be installed via a SW Service Release.

The Monitoring SW is executed by the microprocessor on PC 1772.

### Panel

The Panel SW controls all user interaction, as well as software updating to all subsystems via the PC Card interface.

The Panel SW is stored on PC 1777 Panel. The software must be re-installed if PC 1777 is replaced. New software can be installed via a SW Service Release.

The Panel SW is executed by the microprocessor on PC 1777.

### System ID

The System ID SW is a configuration file, stored on PC 1860 Main Back-Plane, that is unique for each ventilator. The System ID SW will enable the functions selected for this ventilator.

To change the functions of the ventilator, a new System ID SW can be installed via an Option Upgrade.

When replacing PC 1860 Main Back-Plane, a spare part that is factory programmed for the concerned ventilator must be used.



Only personnel trained and authorized by MAQUET shall be permitted to perform installation, service or maintenance of the SERVO-s.



Make sure to prepare the SERVO-s properly before disassembling and assembling. Refer to section 'Hazard notices' in chapter 'Important'.

Any service or maintenance must be noted in a log book.

After any installation, maintenance or service intervention in the SERVO-s, perform a 'Pre-use check'. Refer to the 'SERVO-s Ventilator System – User's Manual' for details.

This product contains electronic and electrical components. Discard disposable, replaced and left-over parts in accordance with appropriate industrial and environmental standards.



### 3. Description of functions

About this chapter .....	3 - 2
Memory types used in the SERVO-s .....	3 - 2
User Interface .....	3 - 2
User Interface controls .....	3 - 2
PC 1777 Panel .....	3 - 2
Loudspeaker .....	3 - 2
Backlight Inverter .....	3 - 3
Touch screen including frame .....	3 - 3
TFT Display with Backlight .....	3 - 3
Patient unit .....	3 - 3
Inspiratory section .....	3 - 3
Expiratory section .....	3 - 6
PC 1860 Main back-plane .....	3 - 8
Pressure transducers .....	3 - 8
PC 1771 Control .....	3 - 8
PC 1772 Monitoring .....	3 - 9
PC 1784 Expiratory Channel .....	3 - 9
Power supply .....	3 - 9
Control cable .....	3 - 11
Optional equipment .....	3 - 12
Alarm output connector .....	3 - 12
Loudspeaker booster kit .....	3 - 12
Isolation shield with drip guard .....	3 - 12

## About this chapter

This text refers to the Functional Main Blocks diagram in chapter 'Diagrams'.

## Memory types used in the SERVO-s

There are four different types of memories used in the SERVO-s:

- Flash memory. For System SW storage. Present on PC 1771, PC 1772, PC 1777, PC 1784 and in the O<sub>2</sub> Sensor. The System SW can be re-installed/updated using a SW Service Release.
- RAM. For temporary storage of software and data. Present on PC 1771, PC 1772 and PC 1777.
- Non-volatile memory. RAM with battery backup. For settings, trends and logs. Present on PC 1771 and PC 1772.
- EEPROM. For PC board information, configuration, calibration data, etc. Present on almost all PC boards and in the O<sub>2</sub> cell. In the O<sub>2</sub> Sensor, an EEPROM is emulated by the Flash memory.

## User Interface

Functional Main Blocks diagram marking: 'U'.

There are two different versions of the User Interface. In this manual, they are described as:

- Type 1 – Up to User Interface S/N 201200 (SERVO-s S/N 02000).
- Type 2 – User Interface S/N 201201 (SERVO-s S/N 02001) and higher.

There is no difference in the clinical operation between the two versions, but the electronics inside the User Interface differs. As a consequence, some of the spare parts are not compatible between the two versions. Further information can be found below and also in the SERVO-s Spare Parts List.

## User Interface controls

Setting of different parameter input values is made with the help of the following different interface devices:

- Main Rotary Dial (rotary encoder with switch).
- Direct Access Knob, 4 each (rotary encoders).
- Membrane buttons. Integrated parts of the Touch screen assembly.
- Touch screen.

## PC 1777 Panel

Some features included on PC 1777 Panel are:

- SIMM (Single In-line Memory Module) mounted on its connector P77. Memory type: SDRAM
- PC Card Slot intended for connection/insert of a PC Card. PC Cards are used to:
  - Download software into the different flash memories situated on PC-boards marked **µP** and into the EEPROM on PC 1860 Main back-plane.
  - Transfer patient and system data for further transfer to a computer.
  - Service purpose.
- Microprocessor µP on this board includes control of the functions of the User Interface.
- ID-PROM: The ID information can be read by the SERVO-s.
- On/Off switch: Switch to Power up or Power down the SERVO-s. Refer to section 'Power supply'. A new design of the On/Off switch and the switch cover was introduced Q2 2007. Refer to chapter 'Disassembling and assembling' for further information.
- Connection for PC (P86): Ethernet port intended for test and service purpose. Connected via a service cable. For future options.
- Microphone used to monitor sounds from the Loudspeaker.

There are two different versions of PC 1777, Type 1 and Type 2. The PC 1777 spare part is not compatible between the two versions.

For PC 1777 of Type 2, System SW version V2.00.04 or higher is required.

Note: The System SW must be re-installed if PC 1777 is replaced.

## Loudspeaker

For generation of sound, e.g. alarm. Connected to P72 on PC 1777 Panel.

The loudspeaker generates different tones with individual sound volumes. At startup and during Pre-use check the function of the loudspeaker is monitored by the microphone on PC 1777. During operation it is continuously monitored through current sensing.

With the optional accessory 'Loudspeaker booster kit', the alarm sound is amplified. Refer to section Optional equipment.

## Backlight Inverter

PC board with driving stage for backlight (lamps) mounted behind the TFT Display. The supply voltage delivered by the Backlight Inverter is 660 V.

The Backlight Inverter is connected to P73 on PC 1777 Panel.

There are two different versions of the Backlight Inverter, Type 1 and Type 2. The Backlight Inverter spare part is not compatible between the two versions.

## Touch screen including frame

The Touch screen implies the touch function of the front panel screen and is interactive with information displayed on the TFT Display. The front panel frame with the touch screen, membrane buttons and DIM sensor forms the assembly Touch screen incl. frame and must be handled as one complete part. The DIM sensor measures the ambient light and the screen brightness is automatically adjusted.

There are two different versions of the Touch screen incl. frame, Type 1 and Type 2. The Touch screen incl. frame spare part is not compatible between the two versions.

## TFT Display with Backlight

The TFT Display is a Thin Film Transistor Screen for color display of picture- and alphanumeric data.

There are two different versions of the TFT Display:

- Type 1 with Backlight consisting of two separate fluorescent lamps mounted behind the TFT Screen.
- Type 2 with Backlight consists of one fluorescent lamp mounted behind the TFT Screen.

The TFT Display spare part is not compatible between the two versions.

The Backlight lamps are driven from the Backlight Inverter. Estimated lifetime (with acceptable brightness level) for the lamps is 30.000 hours. Using the Field Service System (FSS), a time meter for the lamps can be shown. The time meter must be reset after replacement of the lamps.

## Patient unit

### Inspiratory section

Functional Main Blocks diagram marking: 'I'.

The main block Inspiratory Section conveys the breathing gas from its gas inlets for Air and O<sub>2</sub> supply to the patient breathing system. It comprises the following main functions:

- Gas Modules – Air and O<sub>2</sub>.
- Connector Muff.
- Inspiratory Pipe.
- O<sub>2</sub> Sensor/cell.
- Inspiratory Pressure Tube.
- Safety Valve including pull magnet.
- Inspiratory Outlet.
- PC 1861 Pneumatic Back-Plane.

### Gas modules – Air and O<sub>2</sub>

The Air and O<sub>2</sub> Gas Modules regulates the inspiratory gas flow and gas mixture.

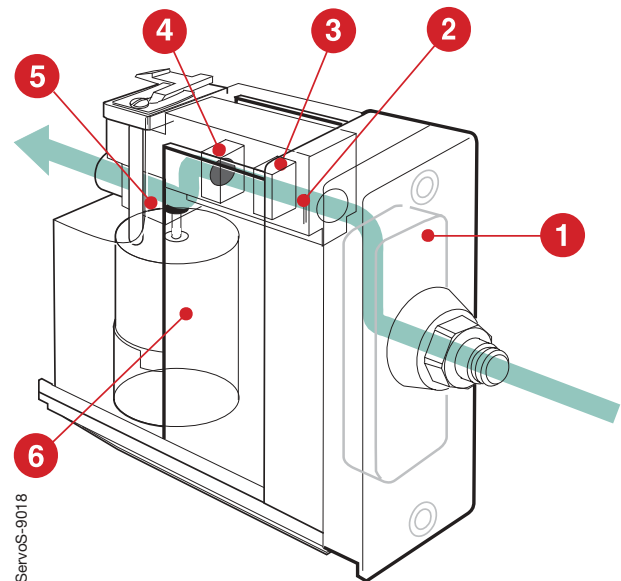

1. Filter
2. Inspiratory valve temperature sensor
3. Supply pressure transducer
4. Flow transducer (Delta pressure transducer and net)
5. Nozzle unit with valve diaphragm
6. Inspiratory solenoid

The Gas Modules are factory calibrated. Each Gas Module must not be disassembled further than described in chapter 'Preventive maintenance'.

### Gas inlet

Gas supply is connected to the ventilators gas inlet nipples. The design of the gas inlet nipples vary according to the standard chosen.

Gas is to be connected from hospital central gas supply or from gas cylinders. The Air supply may be connected from a compressor for medical air.

### Filter

The Filter protects the ventilator from particles in the gas delivered to the Gas Modules. The filter must be replaced during the 'Preventive maintenance'.

**3**

The filter housing and the filter cover are provided with matching guide pins. These guide pins prevent mounting of the filter cover (with gas inlet nipple) on the wrong module.

A non-return valve for the gas inlet is located in the filter cover. This valve will suppress short pressure drops in the gas supply.

The non-return valve is also designed to slowly evacuate compressed gas from the module, if the gas supply to the module is disconnected.

### Inspiratory valve temperature sensor

The temperature of the supplied gas is measured by the Inspiratory Valve Temperature Sensor. This sensor is situated in the gas flow.

The output signal from this sensor is used to compensate for the gas density variations due to temperature.

### Supply pressure transducer

The pressure of the supplied gas is measured by the Supply Pressure Transducer.

The output signal from this transducer is amplified. It is then used to calculate the absolute pressure of the gas to compensate for gas density variations due to pressure.

### Flow transducer

The gas flows through a net (resistance) which causes a pressure drop. The pressure is measured on both sides of this net and the differential pressure value is then amplified.

### Nozzle unit

The plastic Nozzle Unit contains a valve diaphragm. The valve diaphragm, controlled by the Inspiratory Solenoid, regulates the gas flow through the Gas Module.

The complete plastic nozzle unit must be replaced during the 'Preventive maintenance'.

After replacement, allow the diaphragm to settle during approx. 10 minutes before gas pressure is connected to the Gas Module.

### Inspiratory solenoid

The gas flow through the Gas Module is regulated by the Inspiratory Solenoid via the Nozzle Unit.

The current supplied to the solenoid is regulated so that the gas module will deliver a gas flow according to the settings on the User Interface.

### Gas module key

The Gas Modules are provided with a mechanical key to prevent that the module is mounted in the wrong slot.

The key consists of a plastic guide mounted underneath the module and a corresponding guide mounted in the patient unit.

### ID PROM

Each Gas Module is provided with an ID-PROM. The ID information can be read by the SERVO-s.

### **Connector muff**

The Connector Muff connects the Gas Module outlets to the Inspiratory Pipe inlet.

### **Inspiratory pipe**

The Inspiratory Pipe leads the gas from the Connector Muff to the Inspiratory Outlet.

The Inspiratory Pipe comprises:

- Housing for the O<sub>2</sub> Sensor as well as housing and locking lever for the O<sub>2</sub> cell with its bacteria filter.
- Housing for the Safety Valve.
- Connection for measurement of inspiratory pressure.

The pipe is provided with internal flanges with the purpose to improve mixing of O<sub>2</sub> and Air.

The O<sub>2</sub> Sensor requires a changed design of the Inspiratory pipe. The O<sub>2</sub> Sensor and the Inspiratory pipe are equipped with a mechanical key to prevent that the O<sub>2</sub> Sensor is mounted on wrong type of Inspiratory pipe. The O<sub>2</sub> cell can be used on both versions of the Inspiratory pipe.

### O<sub>2</sub> cell

The O<sub>2</sub> cell is mounted in a housing on the Inspiratory Pipe and is protected by a bacteria filter.

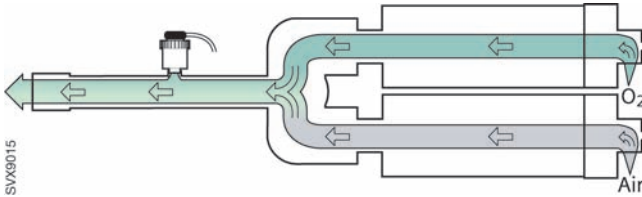

Maintenance including exchange of bacteria filter according to the User's manual. The bacteria filter must also be replaced during the 'Preventive maintenance'.

The O<sub>2</sub> cell gives an output voltage proportional to the partial pressure of oxygen inside the Inspiratory pipe. At constant ambient pressure this output is proportional to the O<sub>2</sub> concentration in percent.

In each O<sub>2</sub> cell, the output signal will stay at a fairly constant level usually within 10–17 mV in normal air and at standard barometric pressure during the life time of the cell.

The life time of the cell is affected by the O<sub>2</sub> concentration. With a concentration (at the cell) in % and expected cell life time in hours the following applies at 25°C (77°F):

$$O_2 \text{ Conc.} \times \text{Expected cell life} = 500\,000\% \text{ hours.}$$

The O<sub>2</sub> cell is automatically calibrated each time a Pre-use check is performed (if O<sub>2</sub> is connected to the ventilator).

If the ventilator has continually been in use for a long time, the measured O<sub>2</sub> concentration may drop due to normal degradation of the O<sub>2</sub> cell. This will activate a nuisance alarm. For further information, refer to the User's Manual.

Note: Pre-use check is recommended to use in order to calibrate the O<sub>2</sub> cell.

An ID PROM is integrated into each O<sub>2</sub> cell. Its ID information and remaining lifetime can be read by the SERVO-s.

### O<sub>2</sub> Sensor

The O<sub>2</sub> Sensor is mounted in a housing on the Inspiratory pipe as an alternative to the O<sub>2</sub> cell.

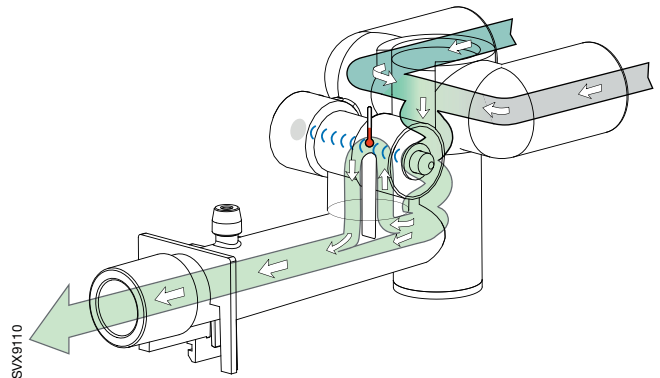

The O<sub>2</sub> Sensor is a measuring device for the inspired oxygen concentration, using ultrasound technique with two ultrasonic transducers/receivers.

The sound velocity in oxygen is lower than in air. By measuring the sound velocity in a binary gas mix, where the two gases are known (air and oxygen), the ratio between the gases can be calculated, i.e. O<sub>2</sub> concentration.

The technique for the O<sub>2</sub> Sensor is similar to the one in the expiratory cassette, with one transducer transmitting an ultrasonic pulse through the gas and the other one receiving the pulse. The measured time difference between the transmission and the reception of the pulse is used for calculation of the sound velocity, which is then used for calculation of the O<sub>2</sub> concentration.

A temperature sensor inside the O<sub>2</sub> Sensor measures the gas temperature and this measurement is used when calculating the O<sub>2</sub> concentration.

Each O<sub>2</sub> Sensor is provided with an ID-PROM. The ID information can be read by the SERVO-s System.

### Inspiratory pressure tube

The Inspiratory Pressure Tube connects the Inspiratory Pipe with the Inspiratory Pressure Transducer. A bacteria filter protects the pressure transducer on PC 1781 Pressure Transducer from contamination.

Maintenance including exchange of bacteria filter according to User's manual. The bacteria filter must also be replaced during the 'Preventive maintenance'.

**Safety valve**

The movable axis of the Safety Valve Pull Magnet controls the opening and closing of the safety valve membrane in the Inspiratory Pipe. The pull magnet is electrically activated (closed) from the main block Expiratory Channel.

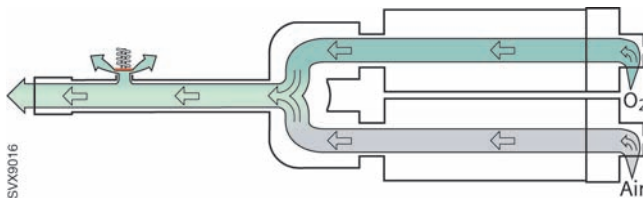

3

When the Safety Valve is not activated, the weight of the pull magnet axis, in combination with the design of the valve membrane, pushes the pull magnet axis downwards. This actuates the Safety Valve to be opened and the inspiratory gas is let out from the Inspiratory Pipe via the Safety Outlet thus enabling a decrease in the inspiratory pressure. The Safety Outlet is covered by a plastic grid.

This is normal safety (pop-off) function.

The opening conditions for the safety valve are:

- The ventilator is switched Off or to Standby.
- The pressure inside the inspiratory pipe is 5 cm H<sub>2</sub>O above the preset Upper Pressure Alarm limit. This condition is controlled by the Monitoring subsystem.
- The pressure inside the inspiratory pipe is 7 cm H<sub>2</sub>O above the preset Upper Pressure Alarm limit. This condition is controlled by the Breathing subsystem.
- The pressure inside the inspiratory pipe is above 117 ±7 cm H<sub>2</sub>O. This is an extra safety function and this situation will normally not occur.
- The safety valve will also be opened by some other alarms, e. g. the Out of gas-alarm.

During startup, the pull magnet is electrically activated so that the pull magnet axis is pushed up (with a clicking sound). This is the normal operational position of the pull magnet; the Safety Valve is normally kept closed.

The safety valve opening pressure is calibrated to 117 ±3 cm H<sub>2</sub>O during each Pre-use check.

**Inspiratory outlet**

22 mm / 15 mm tube connector for the inspiratory tube of the patient breathing system.

**PC 1861 Pneumatic back-plane**

Interconnecting board including connectors for the Gas Modules as well as cable connectors for the Safety Valve and the O<sub>2</sub> Sensor/cell.

**Expiratory section**

Functional Main Blocks diagram marking: 'E'.

The main block Expiratory Section conveys the breathing gas from the patient breathing system to the Expiratory Outlet. It comprises:

- Measurement of expiratory flow
- Connection for measurement of expiratory pressure.
- Controlling element for the regulation of expiratory pressure.

**Expiratory cassette**

The expiratory gas conveying parts and PC 1786 Expiratory Channel Cassette are integrated into one part – the Expiratory Cassette – which can be easily removed for cleaning or exchange. See SERVO-s Ventilator System – User’s manual.

The expiratory cassette can be interchanged between different SERVO-s systems. A Pre-use check is always required after exchanging the expiratory cassette.

A re-designed version of the Expiratory cassette was introduced during Q1 2005 starting with cassette S/N 35000. The new cassette has a larger pressure transducer channel and this will significantly reduce the drying time needed before use.

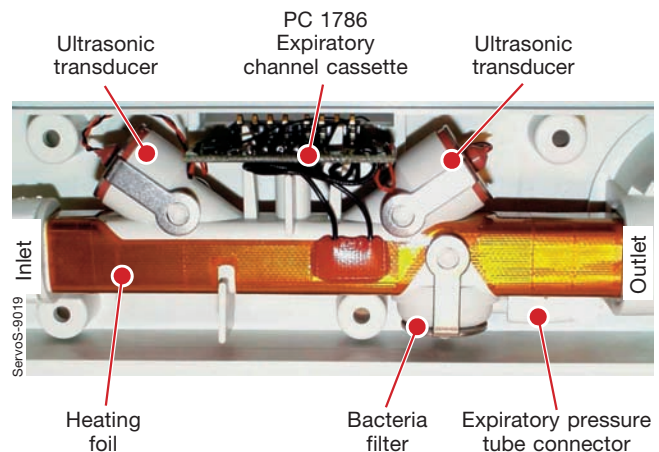

**Expiratory inlet**

22 mm / 10 mm tube connector for the expiratory tube of the patient breathing system. The inlet is designed to make condensed water drip out and allow use of a water trap for such water to be collected. Expiratory inlet bacteria filter can be connected to protect the cassette from contamination.



### Heating foil

An electrical Heating Foil applied on the outside of the expiratory pipe where the Ultrasonic Flowmeter is situated. The purpose of the Heating Foil to reduce condensation and maintain a stable temperature in the expiratory gas.

### Ultrasonic flowmeter

The Ultrasonic Flowmeter is a measuring device for the expiratory gas flow, using ultrasound technique with two ultrasonic transducers/receivers. The measuring process is controlled from the main block PC 1784 Expiratory Channel.

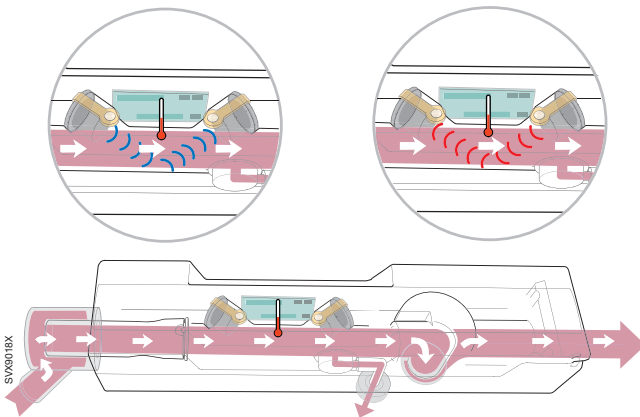

The left hand side transducer is sending out ultrasonic sound that is reflected against the inner wall of the expiratory channel. The ultrasonic sound is received by the right hand side transducer now acting as a receiver. The time from sending to receiving ultrasonic sound in downstream expiratory gas flow is measured.

Then the right hand side transducer (earlier receiving) is sending out ultrasonic sound upstream the expiratory gas flow. The ultrasonic sound is received by the left hand side transducer now acting as a receiver. The time from sending to receiving ultrasonic sound in upstream expiratory gas flow is measured.

The time difference between the downstream and the upstream time measurements provides flow information.

A temperature sensor inside the cassette measures the expiratory gas temperature. This temperature measurement is also used when calculating the expiratory flow.

### Bacteria filter and expiratory pressure tube

Via a Bacteria Filter inside the cassette, the Expiratory Pressure Tube connects the cassette to the Expiratory Pressure Transducer. The filter and the connector are integrated parts of the cassette. The filter protects the transducer on PC 1781 Pressure Transducer from contamination.

### Expiratory valve

The Expiratory Valve consists of a membrane in the cassette that is operated by the axis of the Expiratory Valve Coil. The valve is fully open as long as no power is supplied to the coil.

Operating capacity for the membrane is estimated to 10.000.000 breathing cycles. When this limit is passed or if the membrane for some reason has become defective, it must be replaced. Refer to instructions in chapter 'Disassembling and assembling'.

Remaining operating capacity (in %) for the membrane can be shown in the Status window. Select Status / Exp. cassette to check 'Remaining membrane capacity'. The operating capacity meter must be reset after replacement of the membrane.

### Expiratory valve coil

The movable axis of the Expiratory Valve Coil controls the opening of the Expiratory Valve by pushing the valve membrane into desired position. The power supply to the coil is regulated so that the remaining pressure in the patient system, towards the end of the expiration time, is kept on the PEEP level according to front panel setting.

### Expiratory outlet with expiratory one-way valve

The gas from the patient system leaves the ventilator via this Expiratory Outlet. Backflow via the cassette is prevented by the Expiratory One-Way Valve. Its rubber membrane and valve seat are integrated parts of the Expiratory Outlet.

### PC 1786 Expiratory channel cassette

The PC 1786 Expiratory Channel Cassette is a connection board, integrated into the Expiratory Cassette, for the Ultrasonic Flowmeter and for the Heating Foil. It connects to PC 1785 mounted in the expiratory cassette compartment.

Includes an ID PROM. The ID information can be read by the SERVO-s.

### PC 1785 Expiratory channel connector

The PC 1785 Expiratory Channel Connector is a connector board including signal filters that is mounted in the expiratory cassette compartment. It connects to PC 1786 mounted in the Expiratory Cassette when the cassette is docked to the expiratory cassette compartment.

### PC 1860 Main back-plane

Interconnection board for the PC boards in the left-side part of the patient unit.

The ventilators System ID (Serial No.), configuration, operating time, etc, is stored in an EEPROM on PC 1860. Thus, when replacing PC 1860, a spare part that is factory programmed for the concerned ventilator must be used.

As the preventive maintenance time stamp will be reset when replacing PC 1860, a new time stamp must be set via the Biomed menu. In order to make this new time stamp correct, the preventive maintenance must be performed. Refer to chapter 'Preventive maintenance'.

### Pressure transducers

Functional Main Blocks diagram marking: 'T'.

#### PC 1781 Inspiratory pressure transducer

The pressure, conveyed via the pressure tube connected to this block, is led to and measured by its differential pressure transducer. With differential reference to the ambient pressure, the output signal is proportional to the measured pressure thus giving a linear measurement in the range -40 cm H<sub>2</sub>O to +160 cm H<sub>2</sub>O.

Technical limitation: Pressure exceeding  $\pm 400$  cm H<sub>2</sub>O must be avoided.

Includes an ID PROM. The ID information can be read by the SERVO-s.

#### PC 1781 Expiratory pressure transducer

Function identical to PC 1781 Inspiratory Pressure Transducer.

### PC 1771 Control

Functional Main Blocks diagram marking: 'C'.

The main block Control comprises microprocessor control of Breathing pattern for all different ventilation modes.

Electronics including microprocessor ( $\mu$ P) control to achieve:

1. Regulation of Inspiratory flow which is used during inspiration time in Volume Control (VC) mode.
2. Regulation of Inspiratory pressure which can be used during inspiration time in any mode.
3. Regulation of a constant Inspiratory flow which is used during expiration time in all modes.
4. Respiratory timing pattern including frequency as well as distribution of the duration for Inspiration time, Pause time and Expiration time according to front panel settings.
5. Regulation of Inspiratory flow during inspiration time. The desired total Inspiratory flow value according to front panel settings is used to generate the flow reference signals Insp Flow Ref 1 and Insp Flow Ref 2. The level relation between these two flow reference signals depends on the desired O<sub>2</sub> concentration according to front panel setting. Insp Flow Ref 1 and Insp Flow Ref 2 are used for the control of its respective Gas Module (Air and O<sub>2</sub>).

Regulation of a constant Inspiratory flow during expiration time: The desired constant Inspiratory flow value is the default Bias flow value (see User's manual).

This desired constant Inspiratory flow value is used to generate the flow reference signals Insp Flow Ref 1 and Insp Flow Ref 2 with the same relation and same handling as described above under 'Regulation of Inspiratory flow.....' except this occurs during expiration time.

Includes an ID PROM. The ID information can be read by the SERVO-s.

Note: The System SW must be re-installed if PC 1771 is replaced.

A lithium battery on PC 1771 power supplies the internal memory on the PC board. If the battery on PC 1771 is disconnected or if the battery voltage is too low, user default configurations made via the Field Service System (FSS) and Pre-use check results including transducer calibrations will be erased. The lithium batteries must be replaced after 5 years.

## PC 1772 Monitoring

Functional Main Blocks diagram marking: 'M'.

The main block Monitoring comprises microprocessor ( $\mu$ P) calculation of parameters and monitoring of alarm limits with control of alarms (as well as back-up alarm). The main block Monitoring co-operates with the Loudspeaker in the User Interface.

The PC 1772 Monitoring handles all supervision and alarms in the system. It activates pressure reducing mechanisms, including activation of the safety valve, in case of excessive breathing system pressure.

All alarms are conveyed and displayed on the front panel and the alarm sound is also generated. In case of malfunction in the loudspeaker located on PC 1777 Panel, a backup sound generating device (buzzer) on PC 1772 will be activated automatically. This buzzer is monitored by a microphone at startup and during the Pre-use check.

The following voltages are supervised:

- +24 V
- +12 V
- -12 V
- +5 V
- +3.3 V.

The buzzer on PC 1772 Monitoring generates the alarm signal in case of +5 V or +3.3 V power failure. The buzzer and +5 V / +3.3 V failure logic is powered by backup capacitors in case of power failure.

The alarm signal used by the optional 'Alarm output connection' is generated on PC 1772.

PC 1772 also contains a barometric transducer and the measured barometric pressure is supplied to the other sub-units in the system.

Trending of measured parameters are performed by Monitoring.

A thermistor on PC 1772 monitors the temperature inside the Patient Unit. An alarm is activated if the temperature is  $77 \pm 5$  °C ( $170 \pm 9$  °F) or higher.

Includes an ID PROM. The ID information can be read by the SERVO-s.

Note: The System SW must be re-installed if PC 1772 is replaced.

A lithium battery on PC 1772 power supplies the internal memory on the PC board. If the battery on PC 1772 is disconnected or if the battery voltage is too low, all logs and Pre-use check results including transducer calibrations will be erased. The lithium batteries must be replaced after 5 years.

## PC 1784 Expiratory channel

Functional Main Blocks diagram marking: 'F'.

The main block Expiratory channel comprises microprocessor control to achieve measurement of expiratory flow. The output signal Exp. Flow is used in the main block Control.

Electronics including microprocessor ( $\mu$ P) for handling of:

- All electronic connections to and from the Expiratory Section functions.
- Measurement of airway pressures in both Inspiratory Section and Expiratory Section.
- Control of the Safety Valve functions in the Inspiratory Section.

A thermistor on PC 1784 monitors the temperature inside the Patient Unit. An alarm is activated if the temperature is  $77 \pm 5$  °C ( $170 \pm 9$  °F) or higher.

Includes an ID PROM. The ID information can be read by the SERVO-s.

Note: The System SW must be re-installed if PC 1784 is replaced.

## Power supply

Functional Main Blocks diagram marking: 'P'.

The main block Power Supply comprises conversion of mains power to internal power supply as well as connections for the Battery modules.

The power modes in the SERVO-s System are:

- At Power up, i. e. when the On/Off switch is turned On, all internal voltages will be enabled.
- At Power down, the Power supply system will deactivate the hardware signal Power\_Good.H, and at the same time keep the internal voltages +5 V and +3.3 V for at least 1 ms, in order to let the different subsystems save their current settings in non-volatile memory. Power down can be caused by:
  - Turning the On/Off switch Off.
  - Mains failure resulting in a switch to battery, but the backup battery voltage is too low for proper operation of the system.
  - The system is powered from a battery, but the battery voltage becomes too low for proper operation of the system.

In this Off mode, only charging of Battery modules is enabled (if the system is connected to mains). All other circuitry is un-powered.

- In Standby all circuitry is powered from the Power supply, but no breathing will be active. The operator can set all parameters, including breathing mode, during Standby.

If the internal DC supply voltage +12 V\_Unreg drops below 10 V, due to power supply failure, the power supply source will automatically switch. The following power supply source priority is used:

1. Mains power
2. External +12 V DC supply (if connected)
3. Backup Battery modules.

Power supply selection is managed by:

- PC 1862 – Between Mains power and External +12 V DC supply.
- PC 1863 – Between Mains power/External +12 V DC and Battery module power supply.

3

### Mains inlet

Inlet for mains power supply including grounding connection.

The SERVO-s System will automatically adjust to the connected mains power if the mains power is within specified range. No voltage or frequency setting is required.

The mains inlet is equipped with two mains power fuses, F11 and F12, rated 2.5 A.

### AC/DC Converter

Converts the connected AC Power to the internal DC supply voltage +12 V\_Unreg.

### PC 1862 DC/DC & Standard connectors

Converts the internal DC supply voltage +12 V\_Unreg into the following internal DC supply voltages:

- +24 V
- +12 V
- -12 V
- +5 V
- +3.3 V

All standard connectors are located on this board. The connectors are the following:

- N26 – External +12 V DC supply input. The connector is equipped with a fuse F1, rated 10 A. There are no alarms indicating power supply failure related to the External +12 V DC supply. Thus, when the External +12 V DC supply is used, backup Battery modules must be installed to ensure proper operation.
- N28 – Control cable.
- N29 – RS232.
- P63 – Alarm output connector. Refer to section Optional equipment.

Pin configuration and signal names can be found in chapter 'Diagrams'.

Includes an ID PROM. The ID information can be read by the SERVO-s.

### PC 1863 Power control

Connects and controls charging of the Battery modules.

A Temperature Sensor is integrated on PC 1863. This sensor measures the temperature inside the Patient Unit. The output signal, corresponding to the temperature inside the Patient Unit, is used for regulation of the Internal Fan.

Includes an ID PROM. The ID information can be read by the SERVO-s.

## Battery modules

There are two backup Battery modules connected. The Battery module is a 12 V / 3.5 Ah Nickel-Metal Hydride rechargeable 'smart battery'.

To calculate its own status, the battery uses an internal highly accurate voltmeter, amperemeter and time clock to measure actual charge in and out of the battery. In addition, there are algorithms to compensate for the effects of discharge rate, discharge temperature, self-discharge and charging efficiency, etc.

Even with this technology, the only time at which the battery charge status is absolutely reliable is when it is either completely full or completely empty. What's more, if the battery only sees partial charges and discharges during its application, then it may not get the benefit of a 'full' or 'empty' reference point for some time, and must rely more and more on its calculated figure.

The life span for the Battery module is calculated to two and a half year from manufacturing date. Normal time for logistics and storage are included in this calculation. The calculation corresponds thus to an estimated operational time of two years. Manufacturing date (year-week) is printed on the battery label.

System SW version V2.01.00 (or higher) includes an improved monitoring of the battery status. This System SW will, among others, monitor:

- Expiry date.
- If the operational capacity is too poor for continued usage.

In both cases, battery replacement information will be shown on the User Interface.

Select 'Status / Batteries' on the User Interface to check battery status. For further information, refer to chapter 'Service procedures', section 'Battery modules'.

With the charge status indicator on the User Interface, the four green LEDs on the Battery module are no longer required and will be removed from the Battery modules.

Recharge time for a discharged battery is approx. 3 hours/battery. If a battery is fully discharged, e.g. due to long storage time, it may require up to 12 hours charging time.

Each Battery module includes an ID PROM. The ID information can be read by the SERVO-s.

## Internal fan

The Internal Fan forces cooling air through the Patient Unit. The cooling air flow inside the Patient Unit is indicated in the 'Functional Main Block Diagram'.

The Internal Fan is controlled by the Temperature Sensor on PC 1863 Power control. The fan will start with half effect at approx. 33 °C (91 °F) and with full effect at approx. 43 °C (109 °F). When the temperature drops below approx. 37 °C (99 °F), the fan turns to half effect and when the temperature drops below approx. 27 °C (81 °F), the fan stops.

The air inlet is protected by a filter that must be cleaned or replaced during the 'Preventive maintenance'.

## Control cable

This Control cable connects the Patient Unit and the User Interface. The cable can be partly wound up under a rubber cover on the rear of the User Interface.

Note: The Control cable must only be connected or disconnected when the ventilator is switched Off.

## Optional equipment

### Alarm output connector (optional)

The Alarm output connector P63 is integrated in PC 1862 DC/DC & Standard connectors and mounted on all units. The 'Alarm output'-option must however be enabled in the configuration software to access this function.

The Alarm output connector enables connection of an external alarm signal system to the SERVO-s. High and medium priority alarms are transferred, and the alarm output signal is active as long as the audio alarm is active on the ventilator.

**3**

The Alarm output connector has two contact functions: NO (Normally Open) and NC (Normally Closed). In an alarm situation the open contact will close and the closed one will open. The contacts are independent of polarity and can be used both with AC and DC systems.

Pin configuration and signal names in P63 – Alarm output connector can be found in chapter 'Diagrams'.

For further information, refer to the 'Alarm output connector – Reference Manual'

### Loudspeaker booster kit (optional)

By installing the accessory 'Loudspeaker booster kit', the alarm sound is amplified in a mechanical way. The sound level will be increased significantly. This increased sound level will raise the complete alarm sound setting range (20%–100%), i.e. also the lower sound level range will be increased.

The Loudspeaker booster consists of a rubber collar that is mounted onto the loudspeaker to direct the sound towards the loudspeaker grid.

All parts required for the installation are included in the Loudspeaker booster kit.

### Isolation shield with drip guard (optional)

The optional Isolation shield with drip guard is connected to the Expiratory cassette outlet. The accessory will not affect the expiratory resistance of the system.

The main purpose of this accessory is to protect the expiratory outlet pipe from direct cooling draught favoring condensation.

The drip guard will also collect water that may be condensed during ventilation in connection with use of dual-heated patient tube during active humidification. The water collector has a maximum volume of 100 ml.

Only personnel trained and authorized by MAQUET shall be permitted to perform installation, service or maintenance of the SERVO-s.



Make sure to prepare the SERVO-s properly before disassembling and assembling. Refer to section 'Hazard notices' in chapter 'Important'.

Any service or maintenance must be noted in a log book.

After any installation, maintenance or service intervention in the SERVO-s, perform a 'Pre-use check'. Refer to the 'SERVO-s Ventilator System – User's Manual' for details.

This product contains electronic and electrical components. Discard disposable, replaced and left-over parts in accordance with appropriate industrial and environmental standards.



## 4. Disassembling and assembling

General .....	4 - 2
Preparations .....	4 - 2
Handling PC boards .....	4 - 2
Replacing PC boards .....	4 - 2
Assembling guidelines .....	4 - 2
Tightening torque .....	4 - 2
Threadlocking adhesives .....	4 - 2
User Interface .....	4 - 3
PC 1777 Panel .....	4 - 4
Backlight inverter .....	4 - 6
TFT Display .....	4 - 7
Backlight lamps .....	4 - 9
Touch screen including frame .....	4 - 10
Membrane foil .....	4 - 12
Patient Unit .....	4 - 14
Main and side covers .....	4 - 14
Remove the User Interface from the Patient Unit .....	4 - 15
Gas modules .....	4 - 15
Battery modules .....	4 - 16
PC 1771 Control and PC 1772 Monitoring....	4 - 16
AC/DC Converter .....	4 - 16
PC 1863 Power control .....	4 - 17
PC 1862 DC/DC & Standard connectors .....	4 - 17
PC 1860 Main back-plane .....	4 - 17
Internal fan .....	4 - 18
Inspiratory channel .....	4 - 18
Safety valve membrane .....	4 - 18
PC 1861 Pneumatic back-plane .....	4 - 19
PC 1784 Expiratory channel .....	4 - 19
PC 1785 Expiratory channel connector .....	4 - 20
Expiratory valve coil .....	4 - 20
Expiratory cassette membrane .....	4 - 21
Control cable .....	4 - 22

## General

Disassembling of the SERVO-s is described in this chapter. If not stated otherwise, the assembling procedure is the reverse of the described disassembling procedure.

The illustrations in the SERVO-s Spare Parts List are very useful as a guide when disassembling and assembling the SERVO-s.

### Preparations

Before disassembling or assembling the SERVO-s:

- Set the On / Off switch on the User Interface to Off.
- Disconnect the mains power cable.
- Disconnect the gas supplies (wall and/or cylinder).
- Make sure that all gas conveying parts are cleaned according to instructions in the 'SERVO-s Ventilator System – User's Manual'.

After any service intervention in the SERVO-s, perform a 'Pre-use check' according to instructions in the 'SERVO-s Ventilator System – User's Manual'.

4

## Handling PC boards

The PC boards contain components that are highly sensitive to static electricity.

Those who come into contact with circuit boards containing sensitive components must take certain precautions to avoid damaging the components (ESD protection).

When working with ESD sensitive components, always use a grounded wrist band and grounded work surface. Adequate service tools must also be used.

PC boards (spare parts) must always be kept in protective packaging for sensitive electronic device.

PC boards must not be inserted or removed while the mains power or battery power is applied to the PC boards.

Remove and insert the PC boards very carefully to avoid damage to the connectors.



## Replacing PC boards

The SERVO-s System SW is distributed on different subsystems, located on the following PC boards:

- PC 1771 Control
- PC 1772 Monitoring
- PC 1784 Expiratory Channel
- PC 1777 Panel.

When delivered as spare parts, these PC boards are equipped with a 'System SW version' that may differ from the version on the unit to be repaired.

To keep the 'System SW version' used prior to the PC board replacement, the applicable 'System SW version' must be available on a PC Card for re-installation purposes.

For functionality enhancement, the latest released 'System SW version' is always recommended.

Before installing a new 'System SW version' on a unit, ensure that the software is fully compatible with all HW-, SW- and mechanical components in the unit. If any compatibility conflicts are apparent this will be noted on the 'MCC SW download' website.

## Assembling guidelines

All parts of the unit assembled with screws and nuts are tightened with a specified torque. In the User Interface, some of the screws are also secured with threadlocking adhesives as noticed during disassembling.

In order to maintain these specifications over time, it must be ensured that after any service intervention removed parts are re-assembled and secured according to instructions. Make sure to follow the guidelines stated below.

### Tightening torque

- Thread size M3: 0.95 ±0.05 Nm
- Thread size M4–M6: 3.1 ±0.1 Nm.

### Threadlocking adhesives

- Electrolube Bloc'Lube BLV15ML® on threads in contact with PC boards.
- Loctite 243® on all other threads.



With power supply connected to the SERVO-s, there are energized electrical components inside the unit, e. g. the backlight lamps that are supplied with 660 V by the Backlight Inverter. All personnel must exercise extreme caution if fault tracing or adjustments are performed with power supply connected and with the user interface rear cover removed.

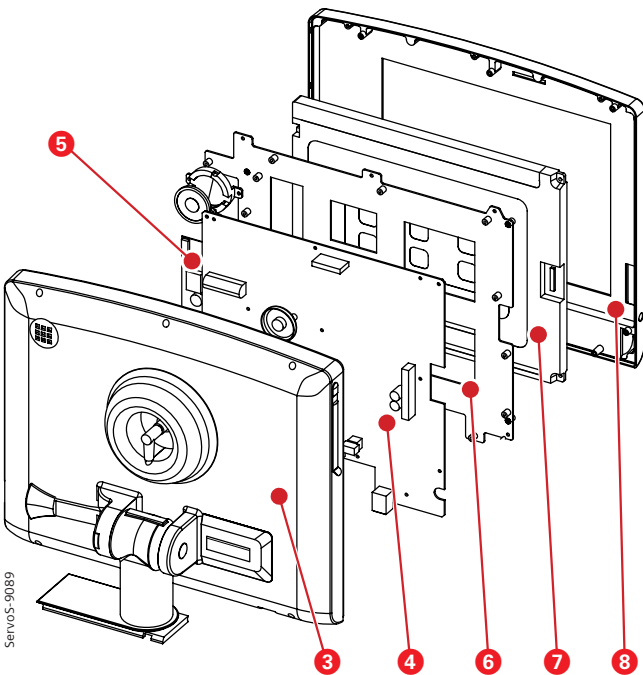
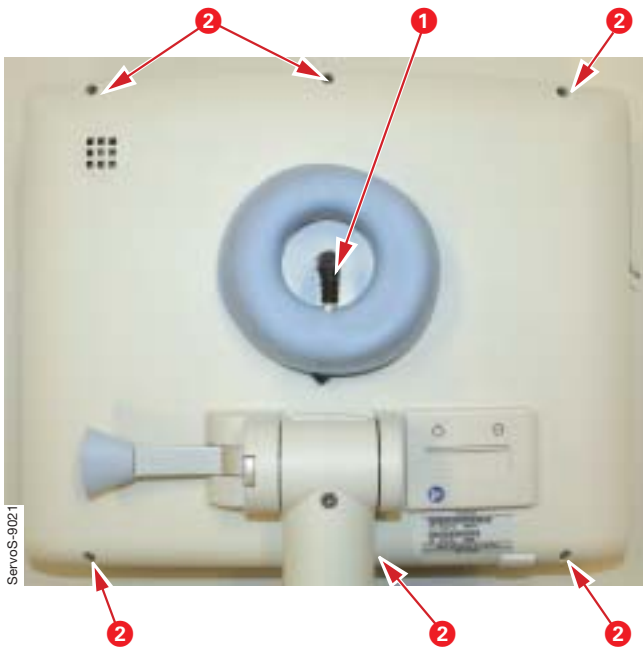

## User Interface

There are two different versions of the User Interface. In this manual, they are described as:

- Type 1 – Up to User Interface S/N 201200 (SERVO-s S/N 02000).
- Type 2 – User Interface S/N 201201 (SERVO-s S/N 02001) and higher.

The electronics inside the User Interface differs and as a consequence, some of the spare parts are not compatible between the two versions. Further information can be found below and also in the SERVO-s Spare Parts List.

The User Interface in the adjacent illustration is equipped with the On/Off switch cover introduced Q2 2007. Refer to section 'PC 1777 Panel' for further information.

To separate the front panel section from the rear cover:

- Disconnect the control cable (1).
- Remove the screws (2). Threadlocking adhesive is not used on these screws.
- Lift off the rear cover from the front panel section.

All parts inside the front panel section are now accessible.

When removing the rear cover:

- The PC Card eject button can catch on the PC Card slot during disassembling. Carefully release the button from the rear cover before removing the cover.

When mounting the rear cover on units with the new version of the On/Off switch and switch cover:

- The switch must be set to 'On' before mounting the rear cover. If set to 'Off', the switch lever will not enter the hole in the switch cover.

The main parts of the User Interface are:

- Rear cover (3).
- PC 1777 Panel (4).
- Backlight Inverter (5).
- Support plate (6).
- TFT Display (7) including Backlight lamps.
- Touch screen incl. frame (8).

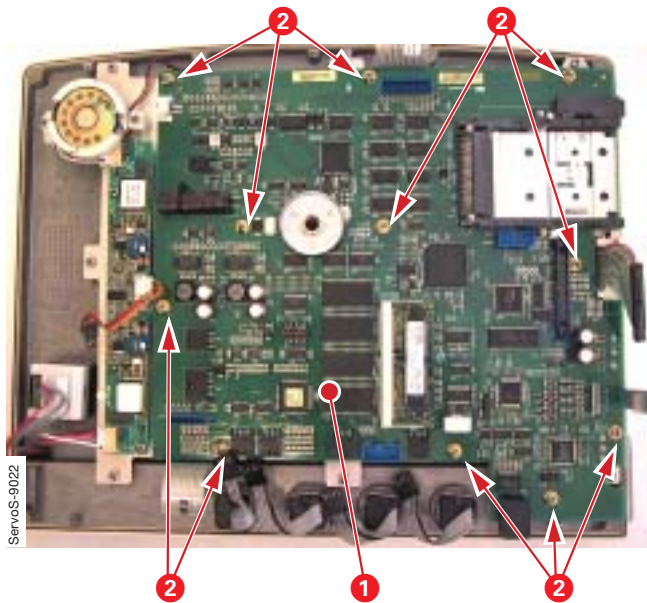

Type 1 = PC 1777A - D

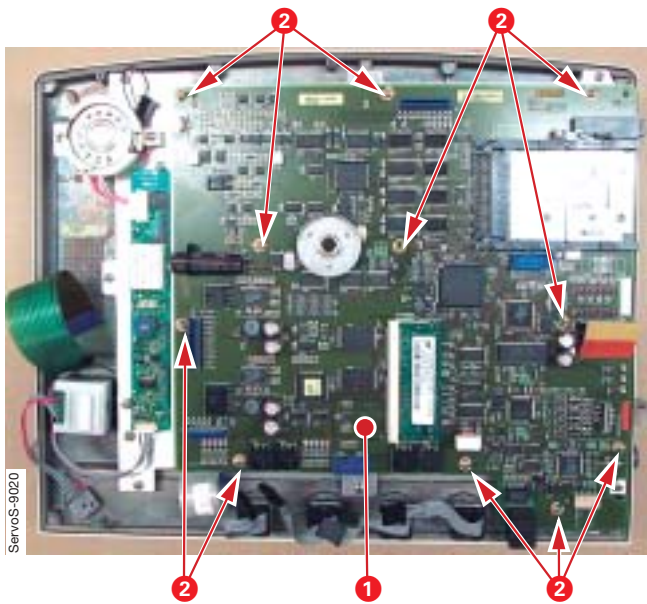

Type 2 = PC 1777F or higher

**PC 1777 Panel**

PC 1777A - D = Type 1

PC 1777F or higher = Type 2

To remove PC 1777 Panel (1):

- Carefully disconnect all cable connectors from PC 1777.
- Remove the screws (2) holding PC 1777.
- Lift off PC 1777.

**Note:** When replacing PC 1777 Panel, it can be necessary to re-install the System SW. For further information, refer to section 'Replacing PC boards' in this chapter. For PC 1777 of Type 2, System SW version V2.00.04 or higher is required.

A new design of the On/Off switch was introduced Q2 2007. This switch also requires a new version of the switch cover. Refer to illustrations below.

With this new design, the switch cover will be kept open when the switch is Off and will be closed only when the switch is On.

PC 1777 Panel, when delivered as spare part, will be equipped with the new design of the On/Off switch. The spare part will thus also include a new switch cover to be mounted on the User Interface.

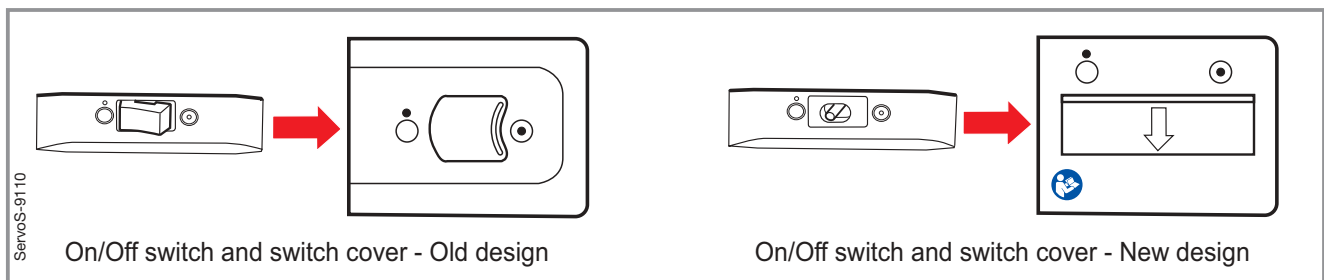

### Replacement of PC 1777 Type 1

PC 1777 Type 1 is discontinued and no longer supplied as spare part. To replace such PC 1777, the 'Replacement kit for PC 1777A-D' must be used.

Note: The Disassembling/Assembling instructions and the illustration below is valid only for the 'Replacement kit for PC 1777A-D'.

The kit contains all parts required for the replacement:

- PC 1777 of Type 2 (6)
- PC 1777-TFT Display cable of Type 2 (10)
- Support plate (5)
- Cushion for the EMC filter (9)
- Retainer (12)
- Screw, M3x8 mm (24 each)
- Screw, M3x6 mm (4 each).

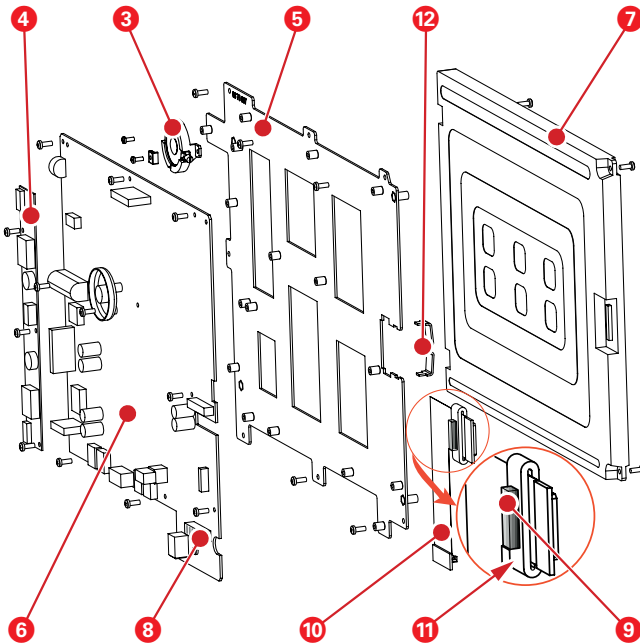

### Disassembling

Installation of the replacement kit must be performed in a clean and dustfree environment as the TFT Display is sensitive to contaminations.

- Separate the front panel section from the rear cover.
- Remove the loudspeaker (3) from the support plate.
- Remove PC board Backlight Inverter (4) from the support plate (5).
- Remove the support plate including PC 1777 Panel (6) and TFT Display (7) from the front panel section.
- Remove the TFT Display from the support plate.
- Discard the old PC 1777, the support plate and the PC 1777-TFT Display cable of Type 1.

### Assembling

- Check type and version of the TFT Display (7).
- Adapt the setting of the DIP switch (8) on the new PC 1777 to the TFT Display. Refer to section 'TFT Display' below.
- Mount the TFT Display (7) onto the new support plate (5) using the new M3x6 mm screws.
- Attach the cushion (9) onto the EMC filter (11) as shown in the illustration.
- Connect the cable (10) to the TFT Display. Organize the cable, place the EMC filter in the support plate recess and secure with the retainer (12) as shown in section 'TFT Display' below.
- Mount the remaining parts onto the new support plate. Use the new M3x8 mm screws.
  - PC 1777 (6)
  - PC board Backlight Inverter (4)
  - Loudspeaker (3).
- Restore the complete assembly into the front panel section.
- Connect all remaining cable connectors.
- Restore the User Interface.

4

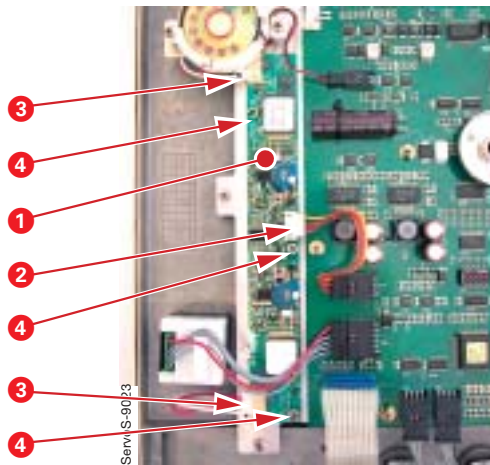

### Backlight Inverter

#### Type 1

To remove the PC board Backlight Inverter (1):

- Carefully disconnect the cable connector (2).
- Carefully disconnect the backlight lamp cable connectors (3).
- Remove the screws (4) holding PC board Backlight Inverter.
- Lift off PC board Backlight Inverter.

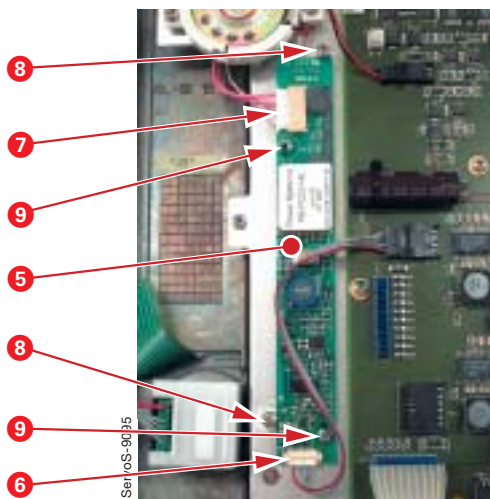

#### Type 2

To remove the PC board Backlight Inverter (5):

- Carefully disconnect the cable connector (6).
- Carefully disconnect the backlight lamp cable connector (7).
- Loosen the screws (8).
- Remove the screws (9) holding PC board Backlight Inverter.
- Lift off PC board Backlight Inverter.

Note: When assembling, make sure that the plastic washers on screws (8) are fitted between the PC board and the screwhead.

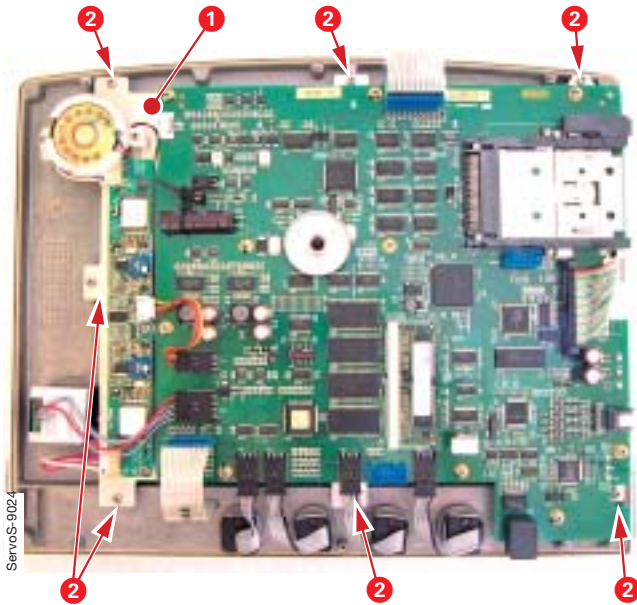

### TFT Display

Note: Disassembling of the TFT Display must be performed in a clean and dustfree environment, as the TFT Display is sensitive to contaminants.

#### Type 1

The TFT Display is mounted under the support plate (1). To remove the TFT Display:

- Carefully disconnect all cables from PC 1777. The Backlight Inverter cable and the Loudspeaker cable can remain connected.
- Carefully disconnect the Backlight lamp cables from PC board Backlight Inverter.
- Remove the screws (2) holding the support plate.
- Lift off the support plate-assembly, including TFT Display and PC boards.

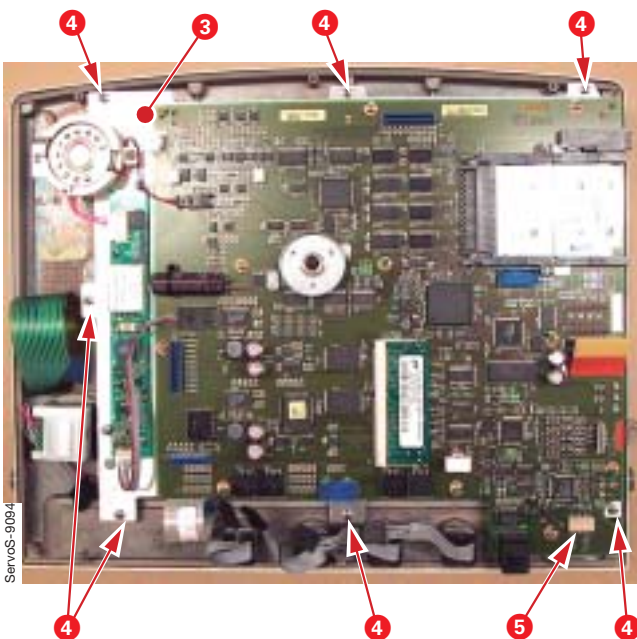

#### Type 2

The TFT Display is mounted under the support plate (3). To remove the TFT Display:

- Carefully disconnect all cables from PC 1777. The Backlight Inverter cable and the Loudspeaker cable can remain connected.
- Carefully disconnect the Backlight lamp cable from PC board Backlight Inverter.
- Remove the screws (4) holding the support plate.
- Lift off the support plate-assembly, including TFT Display and PC boards.

#### DIP switch on PC 1777 Type 2

Faulty DIP switch (5) setting will result in a reversed display image.

Settings for TFT Display:

- SHARP LQ12S41
- SHARP LQ121S1DG11
- NEC NL8060BC31-27

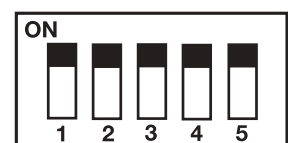

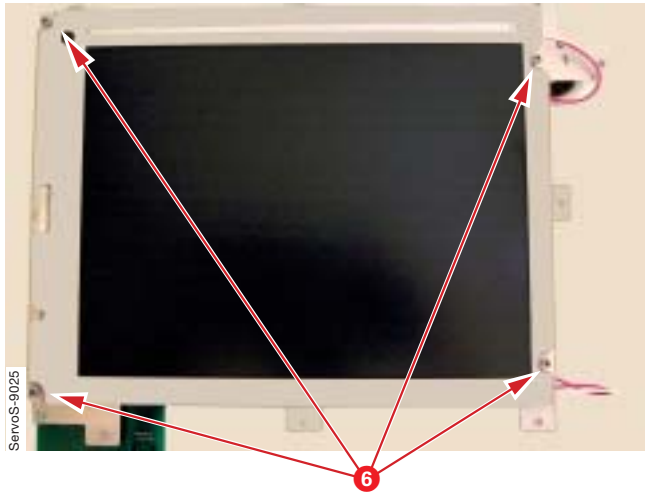

- Remove the screws (6) holding the TFT Display to the support plate.

**Type 1**

- Carefully release the Type 1-cable (7) from PC 1777 as shown in the illustration.

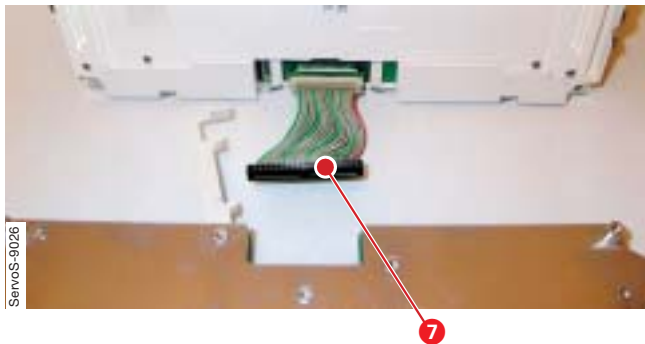

**Type 2**

On units produced prior to Q2 2007, the Type 2-cable is secured with a self-adhesive cushion mounted on the cable connector at the TFT Display. There is also a similar cushion on the cables EMC-filter.

- To disconnect; carefully release the Type 2-cable (8) from PC 1777 as shown in the illustration.



A new locking device for the Type 2-cable was introduced Q2 2007. This device replaces the cushion mounted on the cable connector at the TFT Display. The cushion on the EMC-filter remains.

- Slide the locking device (9) into position until it snaps in place. Note that there is no cushion on the cable (10).
- The adjacent illustration also shows PC 1777 mounted onto the support plate and the Type 2-cable connected to PC 1777. The locking device (9) is visible between the support plate and PC 1777.

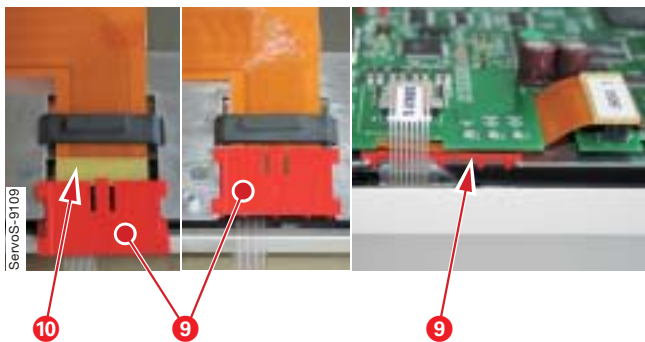

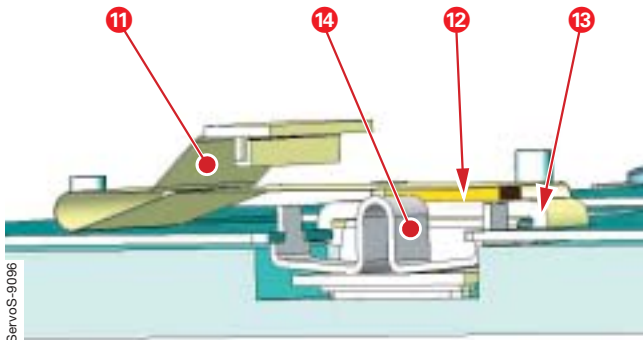

**Units with 'Replacement kit for PC 1777A-D'**

- Carefully release the cable (11) from the recess on PC 1777.

When assembling, make sure that the:

- Cushion (12) is attached to the EMC filter (13).
- EMC filter (13) is placed into the support plate recess.
- Retainer (14) is mounted correctly.

**Backlight lamps**

Using the Field Service System (FSS), a time meter for the lamps can be shown. This time meter must be reset after replacement of the lamps.

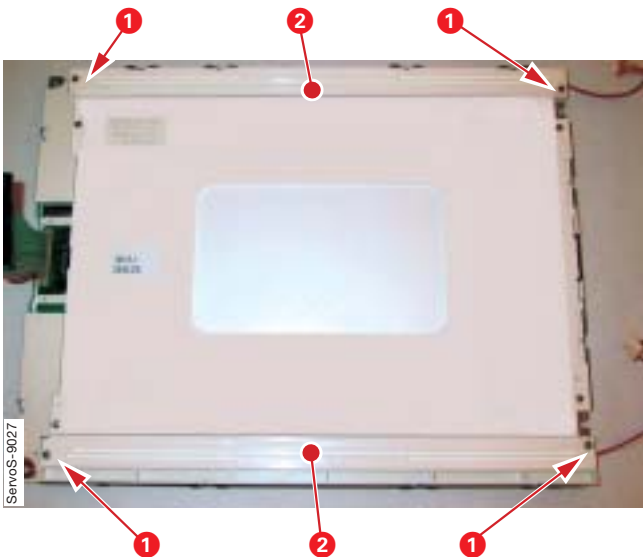

**Type 1**

The Backlight lamp kit for TFT Display Type 1 includes two lamps. Always replace both lamps at the same time.

To access the Backlight lamps:

- Lift off the TFT Display. Refer to section 'TFT Display'.
- Remove the screws (1) holding the lamp.
- Lift off the lamp (2).

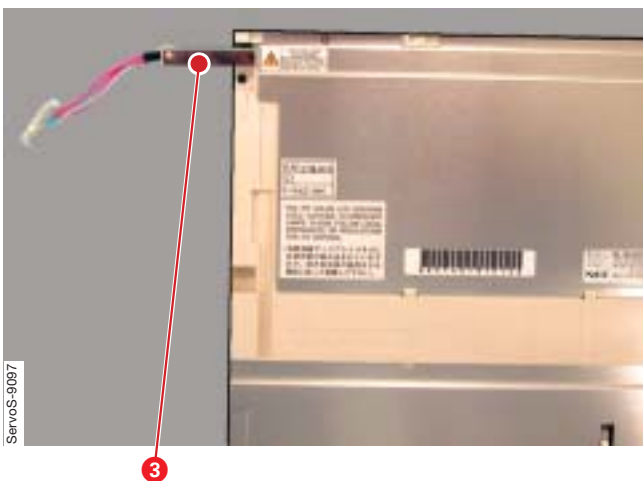

**Type 2**

On TFT Display Type 2, only one Backlight lamp is required.

To access the Backlight lamp:

- Lift off the TFT Display. Refer to section 'TFT Display'.
- Release the snap-in holder and pull out the lamp.
- Lift off the lamp (3).

4

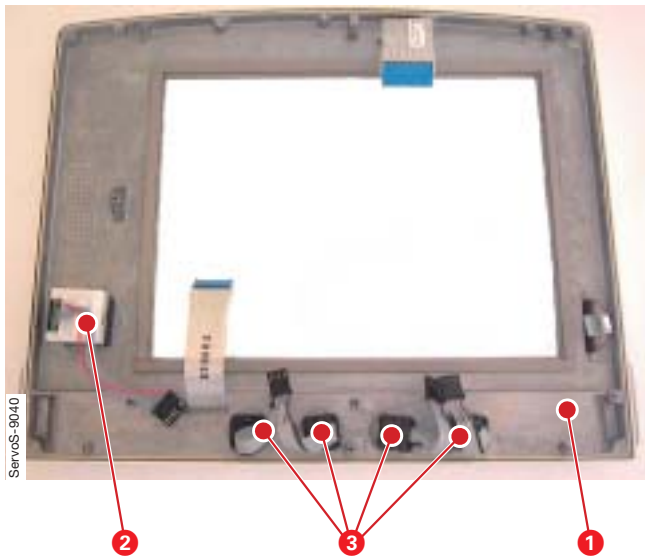

**Touch screen including frame**

The illustration shows Type 1, but the procedure for Type 2 is the same.

To remove the Touch screen including frame (1):

- Lift off the TFT Display. Refer to section 'TFT Display'.
- Remove the Main rotary dial (2):
  - Pull off the Main rotary dial-knob.
  - Remove the nut holding the Main rotary dial.
  - Lift off the Main rotary dial.
- Remove the Direct access controls (3):
  - Remove the cover on each Direct access control-knob.
  - Loosen the nut on each knob and pull off the knobs.
  - Remove the nut holding each Direct access control and lift off the controls.

**Note:** When mounting the Main rotary dial and the Direct access controls on a new Touch screen incl. frame, make sure that the knobs are easy to turn.

**Label strips**

The Touch screen including frame is delivered with label strips which have to be mounted before the unit is taken into operation. Protective foils (1) separate the adhesive areas between the front panel film and the front panel.

Mount the label strips as follows:

- Select the two appropriate label strips:
  - One label strip for the Fixed keys on the upper right-hand area, and
  - One label strip for the Special functions keys on the lower right-hand area of the User Interface.

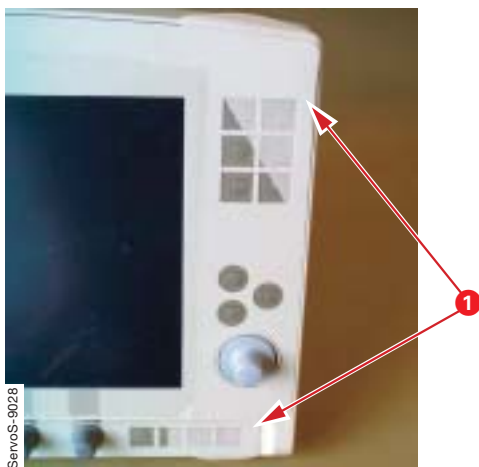

**Fixed keys label**

- Insert the fixed keys label strip (2).
- Check its position through the button windows of the front panel film. Adjust if necessary.

Align the label strip with great care. Once installed the process cannot be reversed.

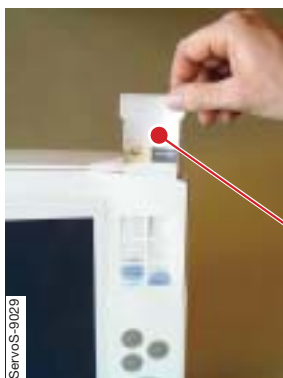



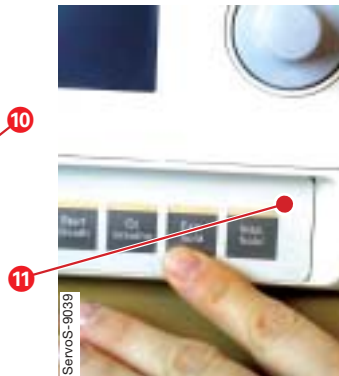
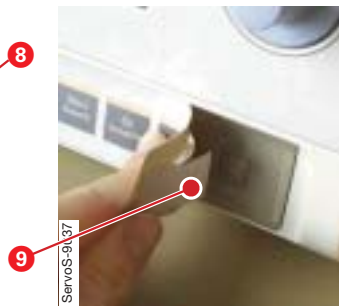
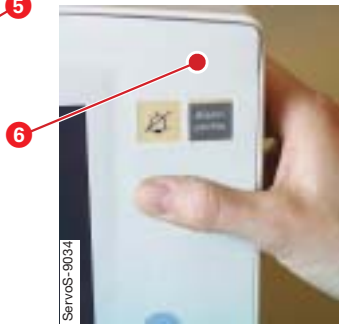
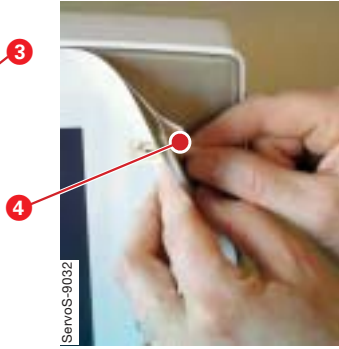

- While holding the label strip in correct position, remove the protective foils (3 and 4).
- Press the label strip against the adhesive area.

- Remove the protective foil (5).
- Press the front panel film (6) firmly against the front panel to ensure proper adhesion.

**Special functions keys label**

- Insert the Special functions keys label strip (7).
- Check its position through the button windows of the front panel film. Adjust if necessary.

Align the label strip with great care. Once installed the process cannot be reversed.

- While holding the label strip in correct position, remove the protective foils (8 and 9).
- Press the label strip against the adhesive area.

- Remove the protective foil (10).
- Press the front panel film (11) firmly against the front panel to ensure proper adhesion.

4

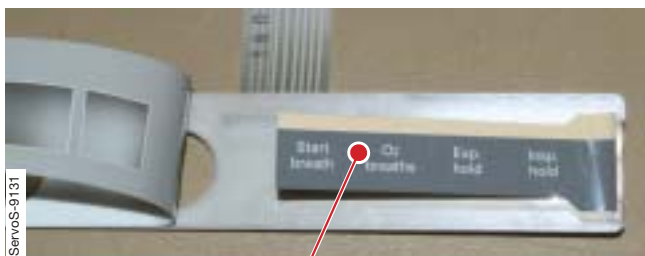
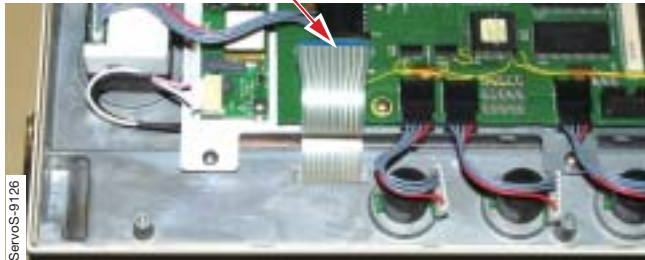
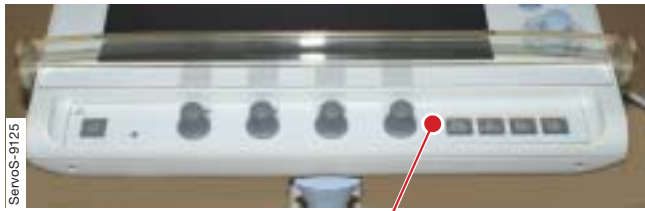

### Membrane foil

**Note:** The membrane foil (1) can only be replaced on User Interface of Type 1.

To replace the membrane foil:

- Separate the front panel section from the rear cover. Refer to section User Interface.
  - Disconnect the membrane foil connector (2) from PC 1777.
  - Remove the four Direct access knobs.
  - Pull off the old membrane foil.
  - Remove all remainings from the old membrane foil on the User Interface front panel. Clean the area for the membrane foil with ethanol or isopropanol.
  - Carefully separate the old membrane foil and remove the label strip (3). The label strip must be used on the new membrane foil.
- Note:** The label strip is not included in the membrane foil spare part.

When assembling the membrane foils adhesive parts, align the parts with great care. Once installed the process cannot be reversed.

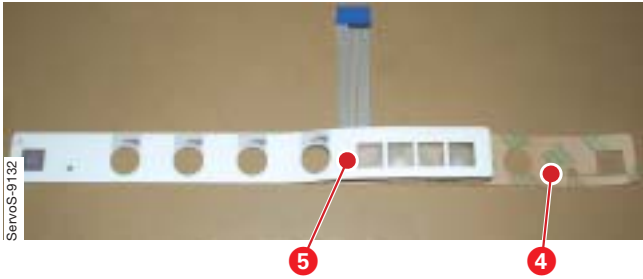

- On the new membrane foil:
  - Carefully remove the protective foil (4).
  - Attach the front panel film (5) onto the membrane button panel.
  - Press the front panel film firmly against the membrane button panel to ensure proper adhesion.

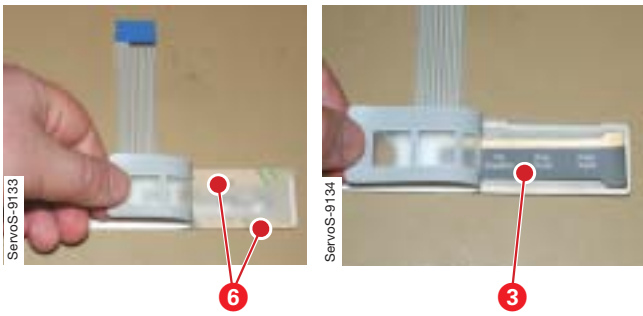

- Remove the two remaining protective foils (6).
- Place the label strip (3) in correct position.



- Press the front panel film firmly against the membrane button panel to ensure proper adhesion.

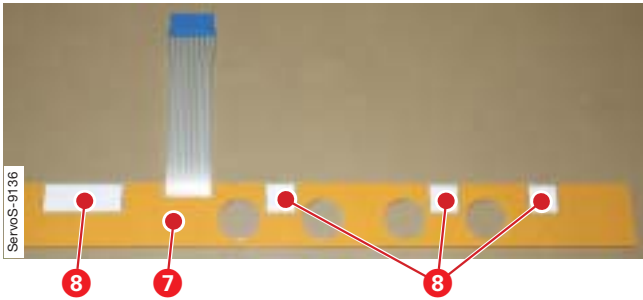

- Remove the protective foils (7) and (8).



- Mount the membrane foil (1) onto the User Interface front panel.
- Press the membrane foil firmly against the front panel to ensure proper adhesion.
- Restore the User Interface:
  - Mount the four Direct access knobs.
  - Connect the membrane foil connector to PC 1777.

4

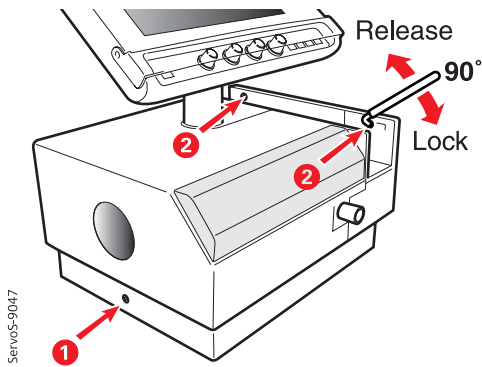

**Patient Unit**

**Main and side covers**

The main cover and the side cover are secured with screws.

- Main cover screw (1).
- Side cover bayonet screws (2). To release or lock these screws, turn the screw 90° as shown in the illustration.

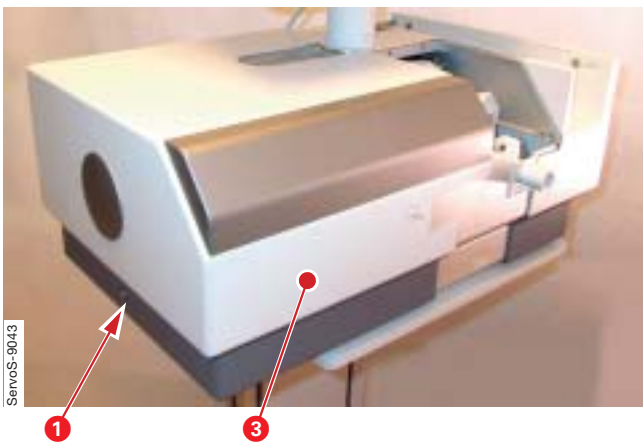

To open the Patient Unit main cover:

- Release the main cover screw (1).
- Pull the main cover (3) to stop.

The main cover is now partly open and the inspiratory section is accessible.

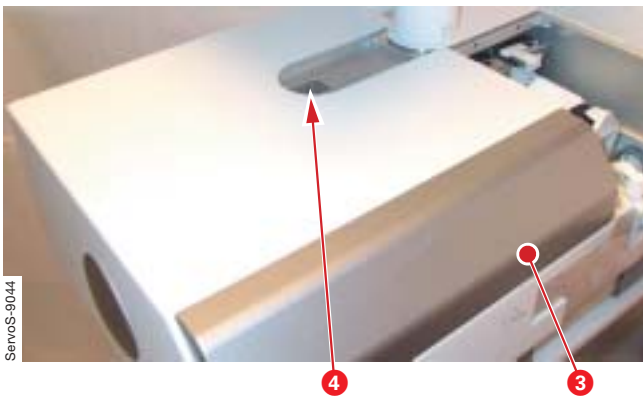

To remove the Patient Unit main cover:

- Open the main cover as described above.
- Press the latch (4) and slide off the main cover (3).

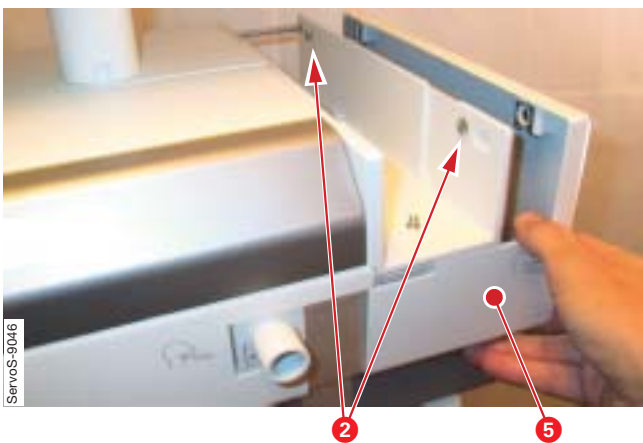

To remove the Patient Unit side cover:

- Release the side cover screws (2).
- Pull off the side cover (5).

With power supply connected to the SERVO-s, there are energized electrical components inside the unit. All personnel must exercise extreme caution if fault tracing or adjustments are performed with power supply connected and with the patient unit covers removed.

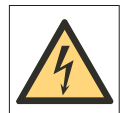

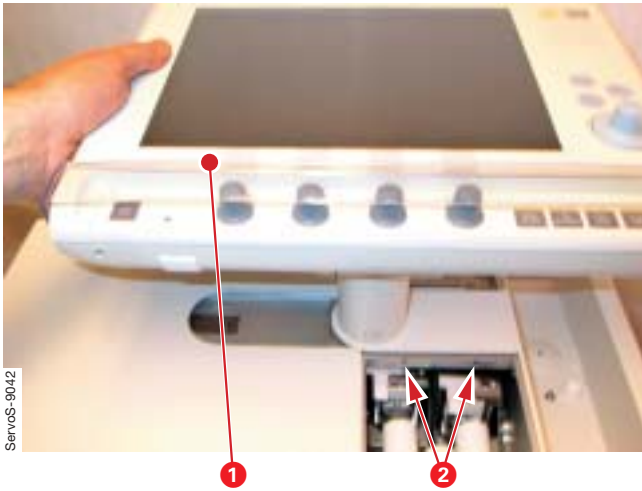

### Remove the User Interface from the Patient Unit

To remove the User Interface from the Patient Unit:

- Disconnect the Control cable at the Patient Unit.
- Open the main cover.
- While firmly holding the User Interface (1), loosen the screws (2).
- Lift off the User Interface.

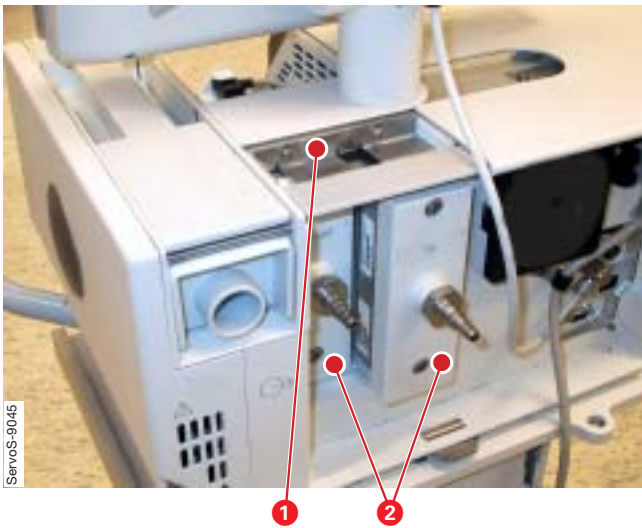

### Gas modules

To remove the gas modules:

- Open the main cover.
- Loosen the two screws holding the locking rail (1).
- Pull off the gas modules (2).

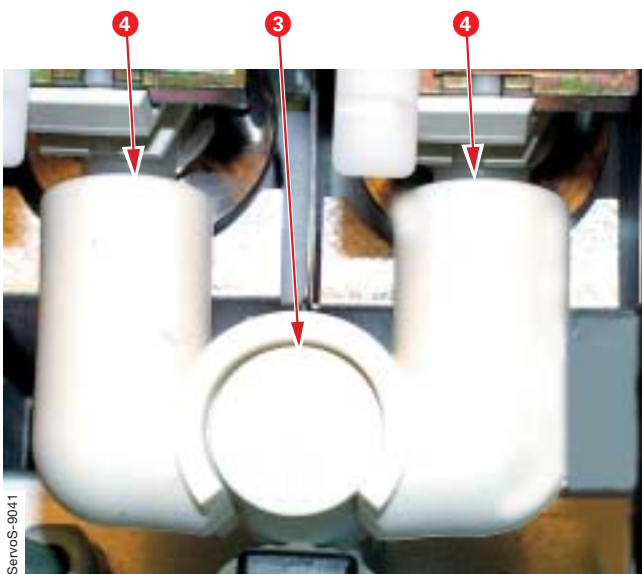

When assembling, make sure that the connector muff properly seals around the inspiratory pipe (3). The connector muff must not be pushed too far onto the nozzle units (4).



### Battery modules

To remove the battery modules:

- Remove the main cover.
- Unscrew and remove the knob (3).
- Pull off the battery modules:
  - Battery module in slot 1 (1)
  - Battery module in slot 2 (2).

The battery modules to be used are the same as for SERVO-i.

**Note:** Replace both battery modules at the same time.

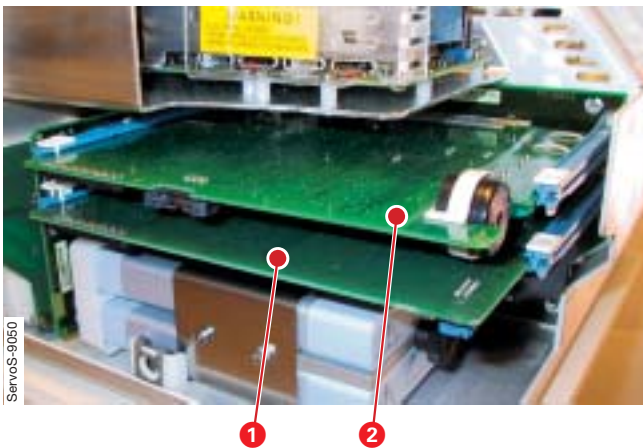

### PC 1771 Control and PC 1772 Monitoring

To remove PC 1771 and/or PC 1772:

- Remove the main cover.
- Release both locking devices at the PC board guides for the concerned PC board.
- Carefully pull out and lift off the concerned PC board:
  - PC 1771 Control (1)
  - PC 1772 Monitoring (2).

**Note:** When replacing PC 1771 Control or PC 1772 Monitoring, it can be necessary to re-install the System SW. For further information, refer to section 'Replacing PC boards' in this chapter.

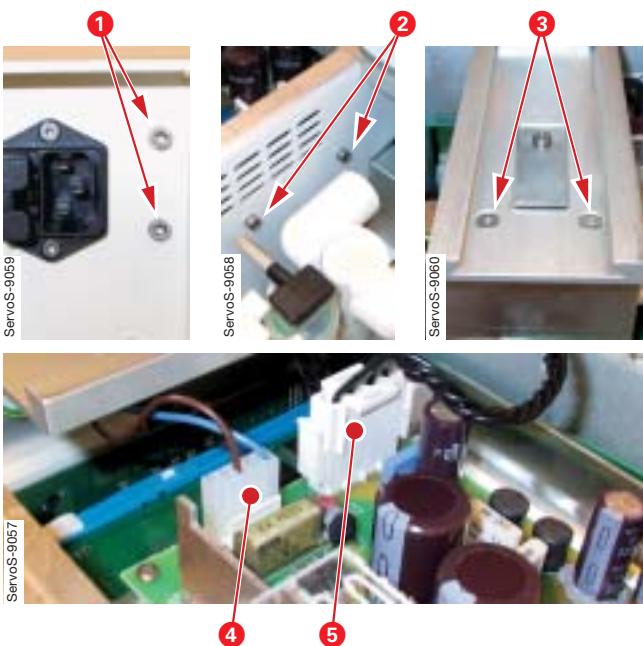

### AC/DC Converter

To remove the AC/DC Converter:

- Remove the main cover.
- Remove the screws holding the AC/DC Converter:
  - Screws (1) at the mains inlet
  - Screws (2) inside the inspiratory section. Pull out the O<sub>2</sub> gas module to access the screws.
  - Screws (3) at the main cover rail.
- Carefully pull out the AC/DC Converter to make the cable connectors accessible.
- Disconnect the mains power cable (4) and the converter cable (5).
- Lift off the AC/DC Converter.



ServoS-9051

1

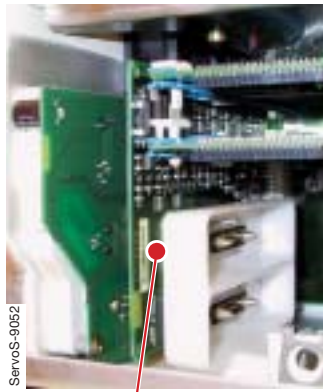

ServoS-9052

2



ServoS-9053

1

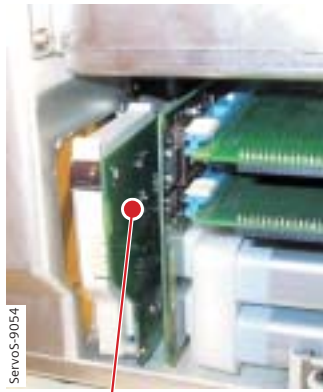

ServoS-9054

2

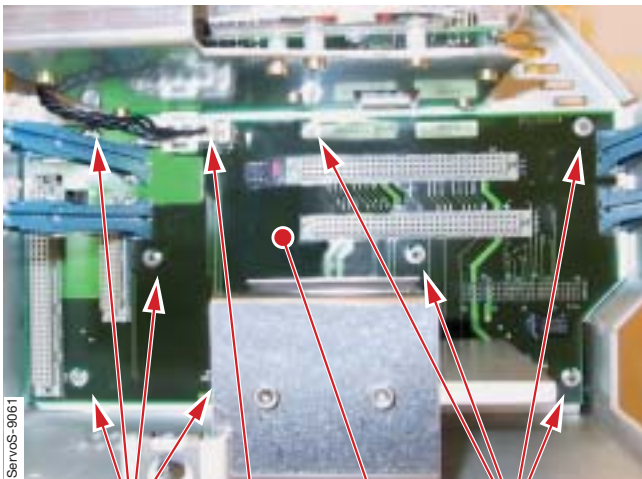

ServoS-9061

2

1

3

2

### PC 1863 Power control

To remove PC 1863:

- Remove the main cover.
- Remove the battery modules.
- Remove the screws (1) at the underside of the Patient Unit. These screws are accessible also with the SERVO-s mounted on a Mobile cart.
- Carefully pull out and lift off PC 1863 (2).

### PC 1862 DC/DC & Standard connectors

To remove PC 1862:

- Remove the main cover.
- Remove the screws (1) on the rear panel.
- Carefully pull out and lift off PC 1862 (2).

### PC 1860 Main back-plane

To remove PC 1860:

- Remove the main cover.
- Remove the:
  - Battery modules
  - PC 1771 Control
  - PC 1772 Monitoring
  - PC 1863 Power control
  - PC 1862 DC/DC & Standard connectors
  - Internal fan.
- Disconnect the converter cable (1).
- Remove the screws (2).
- PC 1784 Expiratory channel and PC 1861 Pneumatic back-plane is connected to the rear side of PC 1860. Carefully pull out and lift off PC 1860 (3).

**Note:** The ventilators System ID, configuration, operating time, etc, is stored in an EEPROM on PC 1860. Thus, when replacing PC 1860, a spare part that is factory programmed for the concerned ventilator must be used. For further information refer to chapter 'Description of functions'.

4

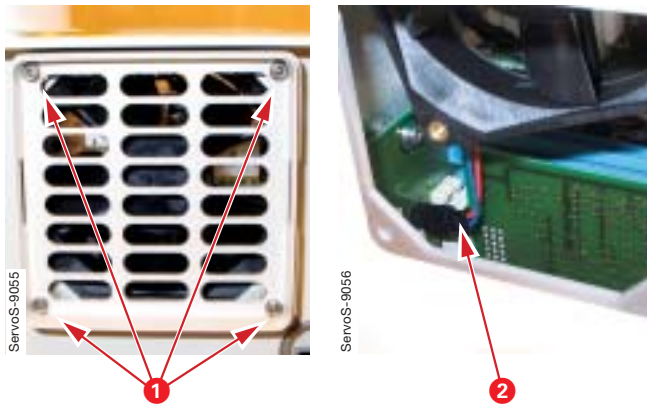

**Internal fan**

To remove the internal fan:

- Remove the main cover.
- Remove PC 1862 DC/DC & Standard connectors (to make the internal fan cable connector accessible).
- Remove the internal fan filter.
- While holding the internal fan, remove the screws (1).
- Disconnect the internal fan cable connector (2)
- Lift off the internal fan.

**Note:** An arrow on the fan housing indicates the air flow direction. When mounting the fan, make sure that the cooling air flow is directed into the unit.

**Inspiratory channel**

Removal of the inspiratory channel, as well as removal of O<sub>2</sub> Sensor and O<sub>2</sub> cell/filter, is described in the User's manual.



**Safety valve membrane**

To remove the safety valve membrane:

- Remove the inspiratory channel.
- Release the latches (1), one on each side of the safety valve housing, and lift off the membrane holder (2).
- The membrane (3) and the valve seat (4) are now accessible, e.g. for inspection and cleaning.

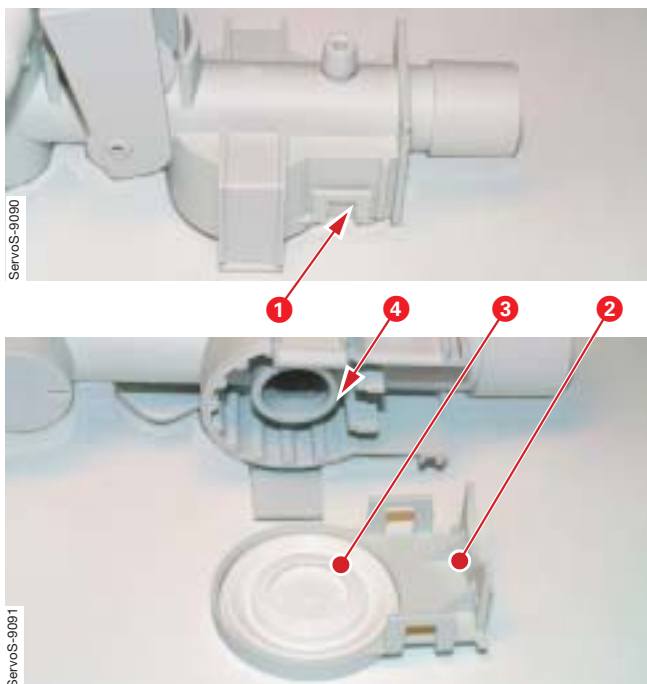



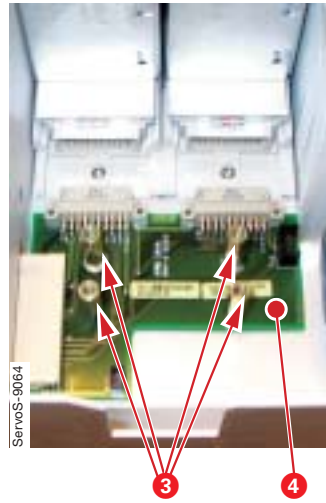
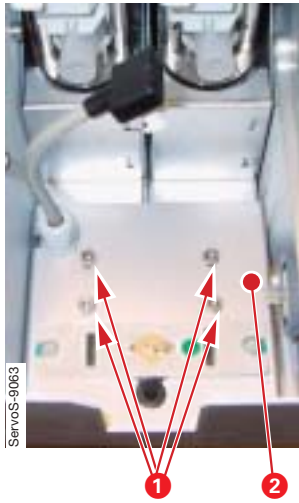

### PC 1861 Pneumatic back-plane

To remove PC 1861:

- Remove the main cover.
- Remove PC 1860 Main back-plane. (PC 1861 cannot be removed with PC 1860 mounted.)
- Remove the inspiratory channel including filter for the inspiratory pressure transducer.
- Remove the screws (1).
- Carefully lift the mounting plate (2) and disconnect the O<sub>2</sub> Sensor/cell connector and the safety valve pull magnet connector from PC 1861.
- Lift off the mounting plate (2). The safety valve pull magnet is mounted on this plate.
- Pull out the gas modules to disconnect them from PC 1861.
- Remove the threaded studs (3).
- Lift off PC 1861 (4).

**Note:** When assembling, the mounting plate (2) must be adjusted to correspond with the inspiratory channel latches.

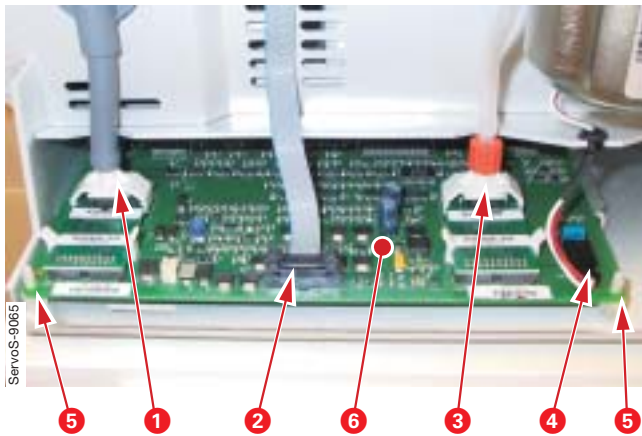

### PC 1784 Expiratory channel

To remove PC 1784:

- Remove the side cover.
- Disconnect the:
  - Inspiratory pressure transducer tube (1)
  - PC 1785 cable connector (2)
  - Expiratory pressure transducer tube (3)
  - Expiratory valve coil cable connector (4).
- Release PC 1784 from the standoffs (5).
- Carefully pull out and lift off PC 1784 (6).

**Note:** When replacing PC 1784 Expiratory channel, it can be necessary to re-install the System SW. For further information, refer to section 'Replacing PC boards' in this chapter.

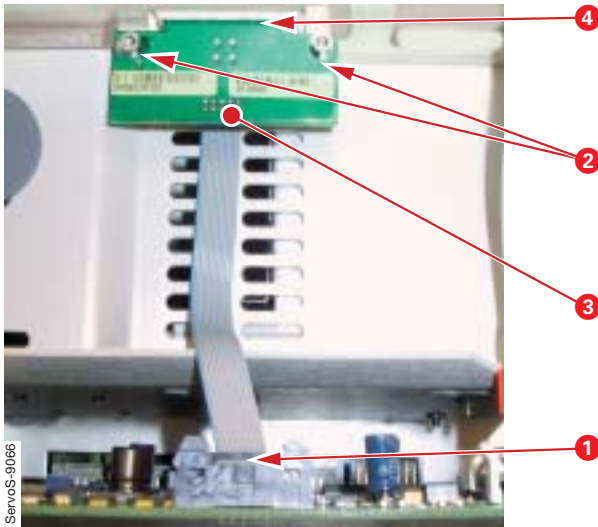

**PC 1785 Expiratory channel connector**

To remove PC 1785:

- Remove the side cover.
- Disconnect the PC 1785 cable connector (1).
- Remove the screws (2).
- Pull down and lift off PC 1785 (3).

**Note:** When assembling, make sure that the rubber seal (4) is correctly seated around PC 1785.

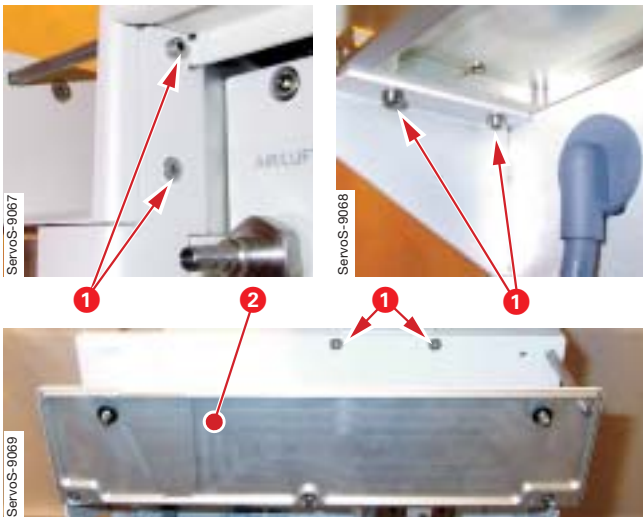

**Expiratory valve coil**

To remove the expiratory valve coil:

- Remove the side cover.
- Disconnect pressure transducer tubes and cable connectors from PC 1784. Refer to section 'PC 1784 Expiratory channel'.
- Remove the screws (1).
- Lift off the cassette compartment (2).

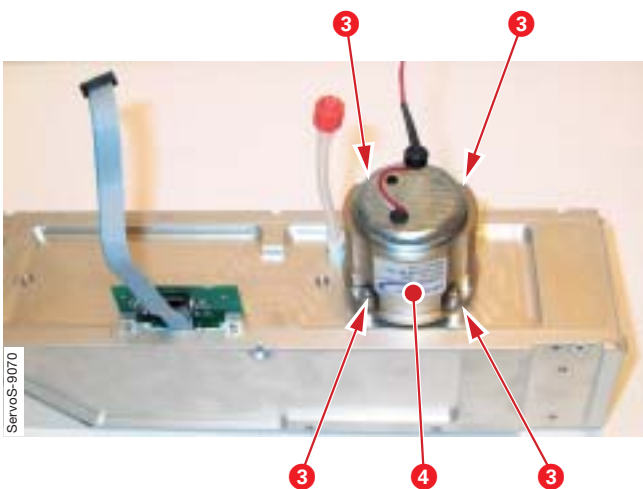

- Remove the screws (3).
- Lift off the expiratory valve coil (4).

It is very important for the function of the expiratory valve that the valve membrane is removed and mounted correctly as described below.

### Expiratory cassette membrane

The expiratory cassette is a complete unit and must not be disassembled. The only part that can be replaced is the valve membrane.

Operating capacity for the membrane is estimated to 10.000.000 breathing cycles. When this limit is passed or if the membrane for some reason has become defective, it must be replaced.

Remaining operating capacity (in %) for the membrane can be shown in the Status window. Select Status / Exp. cassette to check 'Remaining membrane capacity'. The operating capacity meter must be reset after replacement of the membrane.

**Note:** If the metal washer has been separated from the membrane, it is important that the washer is correctly mounted.

- Washers of old version have a raised hub (1) that must be facing outwards as shown in the adjacent illustration.
- Washers of new version do not have this raised hub and can be mounted in both directions.

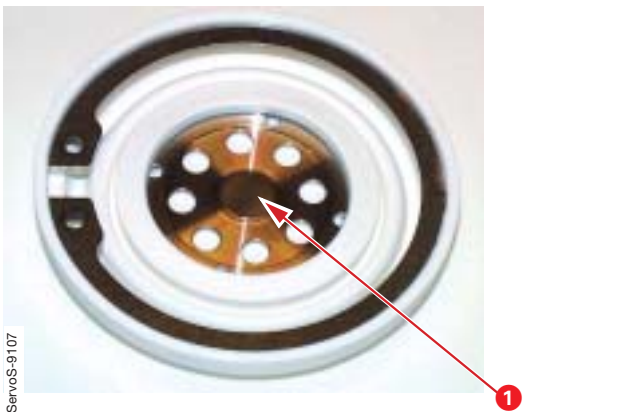

To remove the valve membrane from the cassette:

- Carefully remove the membrane including retaining ring using a suitable retaining ring pliers.

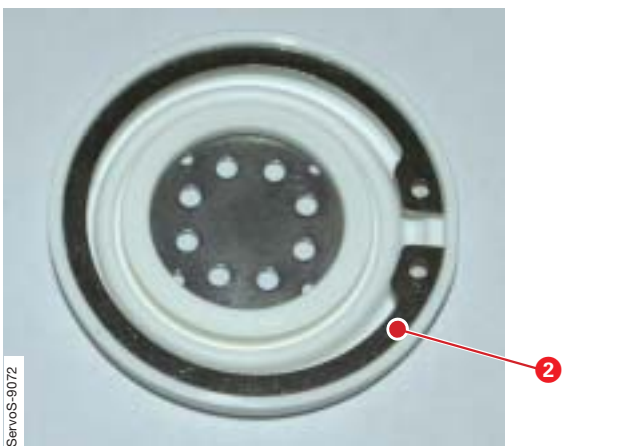

To mount the valve membrane into the cassette:

- Place the retaining ring (2) correctly into the membrane.

It is very important that the valve membrane and the membrane seat in the cassette is clean. Dirt particles can create leakage in the cassette.

4



- Place the membrane onto the cassette as shown in the illustration.



- Squeeze the retaining ring pliers and carefully press the membrane in place into the cassette as shown in the illustration.



- Carefully release and remove the pliers.
- Check that the membrane is not deformed by the retaining ring. If necessary, remove the membrane and redo the complete mounting procedure.
- Mount the expiratory cassette onto the Patient Unit.
- Reset the operating capacity meter after replacement of the membrane. To access the reset button, select Menu / Biomed / Service.

**Control cable**

The control cable connectors must be connected carefully to avoid damages on the connector pins.

- Carefully find the correct position; the connector pins and the guides in the connectors must correspond. Do not turn the connector while inserting!
- When correct position is found, insert the connector.
- Secure the connector with its locking ring.

The illustration shows the Patient Unit connector, but the procedure for the User Interface connector is the same.

Note: The Control cable must only be connected or disconnected when the ventilator is switched Off.

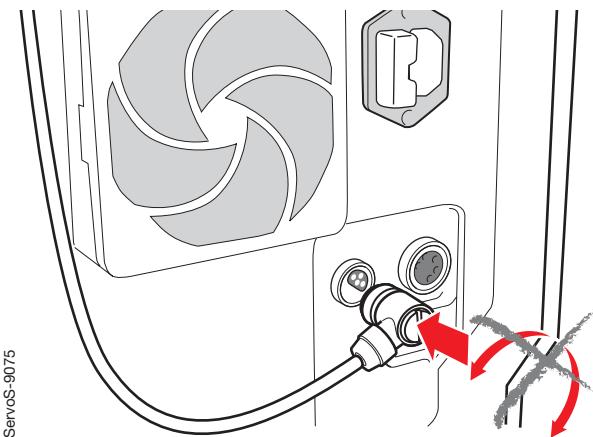

Only personnel trained and authorized by MAQUET shall be permitted to perform installation, service or maintenance of the SERVO-s.



Make sure to prepare the SERVO-s properly before disassembling and assembling. Refer to section 'Hazard notices' in chapter 'Important'.

Any service or maintenance must be noted in a log book.

After any installation, maintenance or service intervention in the SERVO-s, perform a 'Pre-use check'. Refer to the 'SERVO-s Ventilator System – User's Manual' for details.

This product contains electronic and electrical components. Discard disposable, replaced and left-over parts in accordance with appropriate industrial and environmental standards.



## 5. Service procedures

- Battery modules ..... 5 - 2
- Replacing the lithium batteries on PC 1771 and PC 1772 ..... 5 - 3
- Using the Menu and Biomed key ..... 5 - 4
  - Menu ..... 5 - 4
  - Biomed ..... 5 - 4
- Software installation ..... 5 - 6
  - General ..... 5 - 6
  - Software information ..... 5 - 6
  - Software delivery ..... 5 - 6
  - Software installation procedure ..... 5 - 6
- Field Service System ..... 5 - 6
  - General ..... 5 - 6
  - Field Service System functions ..... 5 - 6

The life span for the Battery module is calculated to two and a half year from manufacturing date. Normal time for logistics and storage are included in this calculation. The calculation corresponds thus to an estimated operational time of two years. Manufacturing date (year-week) is printed on the battery label.

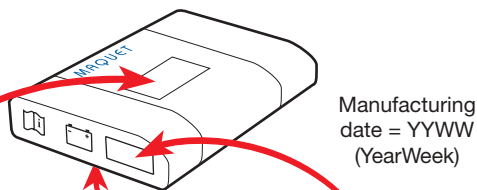

Version 1	Version 2	Version 3
<b>Batteri Module</b> Part No.: 64 87 180 E407E Manufacturing Date: 0245 Hardware Version: xxxxx	Manufacturing Date : 0420 Hardware Revision : xxxxx Batch No : xxxxx	Man. Date : 0520 S N xxxxx

5



### Battery modules

System SW version V2.01.00 (or higher) includes an improved monitoring of the battery status. Select 'Status / Batteries' on the User Interface to check battery status. Refer to the illustrations below.

On ventilators with this improved battery monitoring, the batteries condition and capacity are verified during the Pre-use check and also continuously during operation of the unit. No further functions checks of the batteries are required.

With this improved battery monitoring, the Battery status window shows:

- Usable backup time. Calculated as the sum of the estimated backup time for the connected Battery modules reduced with 10 minutes as an extra safety feature.
- Slot number. Note that slot 1 is the lower slot and slot 2 is the upper.
- Battery module S/N.
- Charge indicator for each battery, where:  
 0 boxes filled = < 10% relative charge  
 1 box filled = 10–25% relative charge  
 2 boxes filled = 26–50% relative charge  
 3 boxes filled = 51–75% relative charge  
 4 boxes filled = 76–100% relative charge

Recharge time for a discharged battery is approx. 3 hours/battery. If a battery is fully discharged, e.g. due to long storage time, it may require up to 12 hours charging time.

With the charge status indicator on the User Interface, the four green LEDs on the Battery module are no longer required and will be removed from the modules.

- Remaining operating time in minutes for each battery.

Furthermore, an activity instruction, displayed directly next to the operating time, may show:

- Expires soon. Message activated if expiry date will be reached within 60 days.
- Replace battery. The battery must be replaced and discarded. Message activated if:
  - The batteries expiry date is passed and its life span is exceeded. Note: Due to the age of the battery, the calculated backup time may in this case not be reliable. Even if the battery indicates a significant backup time, the battery must be replaced.
  - or
  - The batteries operational capacity is too poor for continued usage, caused e.g. by the chemical process in an aging battery.

## Replacing the lithium batteries on PC 1771 and PC 1772

The lithium batteries must be replaced after 5 years. A Technical error message will appear on the screen if the battery voltage level is too low.

Always replace both batteries at the same time to keep the same replacement date for both batteries.

### Preparations

- Set the On/Off switch on the control unit to **Off**.
- Disconnect the mains power cable.
- Disconnect the gas supplies (wall and/or cylinder).
- Remove patient tubing.

### Replacing the lithium battery

- The lithium batteries are mounted on ESD sensitive PC boards. Refer to chapter 'Disassembling and assembling', section 'Handling PC boards' for further information regarding ESD sensitive components.
- Remove the Patient Unit main cover. Refer to chapter 'Disassembling and assembling'.
- Carefully pull out PC 1771 and PC 1772.

**Note:** Do not remove the cable connector (1). Information stored in the PC board memory will be erased if the connector is removed:

- If the battery on PC 1771 is disconnected; user default configurations made via the Field Service System (FSS) and Pre-use check results including transducer calibrations will be erased.
- If the battery on PC 1772 is disconnected; all trends, all logs and Pre-use check results including transducer calibrations will be erased.

- There are two equal battery connectors (2 and 3) on the PC boards. Connect the new battery to the un-used connector. The memory functions are now secured by the new battery.
- Cut the cable ties holding the old battery (4) to the PC board.
- Disconnect and remove the old battery.
- Mount the new battery onto the PC board using new cable ties as shown in the illustration.
- Insert the PC board into the correct PC-board slot and reassemble the Patient Unit.

After any maintenance or service of the SERVO-s, perform a 'Pre-use check'. Refer to the 'SERVO-s Ventilator System – User's Manual'.

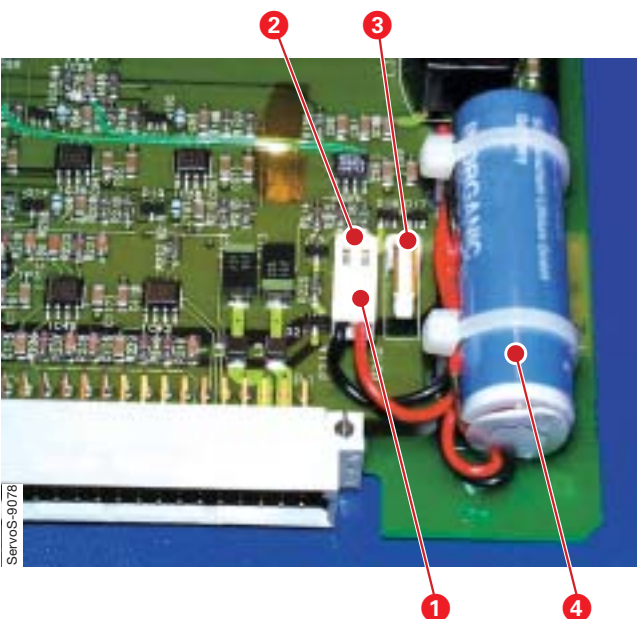

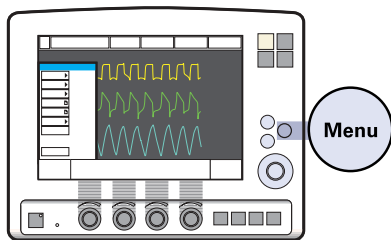

## Using the Menu and Biomed key

The 'Menu' and 'Biomed' functions are useful tools during service.

The adjacent flowchart shows the 'Biomed' functions in System version V3.1. A complete set of flowcharts showing all 'Keys' and 'Screen touch pad' functions can be found in the 'SERVO-s Ventilator System – User's Manual'.

### Menu

Pressing the fixed key 'Menu' will open the 'Menu window' on the User Interface.

The 'Menu' is active in Standby and during ventilation mode, but the available submenus differs.

Possible selections in the 'Menu' window are:

- Alarm
- Review
- Compliance compensation
- Biomed
- Panel lock

### Biomed

Submenu 'O<sub>2</sub> cell adaptation', active only during ventilation modes in units with O<sub>2</sub> cell. No access code is required.

All other 'Biomed' submenus are available only during Standby and requires an access code. The default code is **1973**, but the code can be changed in the Biomed menu.

### Service

Available only in Standby mode.

#### Event Log:

Displays Event logs. Useful during troubleshooting.

#### Service Log:

Displays Service logs. Useful during troubleshooting.

#### Report PM:

This button must be pressed when a Preventive Maintenance has been performed. This will reset the timer that indicates operating hours until next Preventive Maintenance. Default value is 5,000 hours. In the Report PM submenu, it is possible to enter a new value, e.g. if the time stamp was erased during a SW installation.

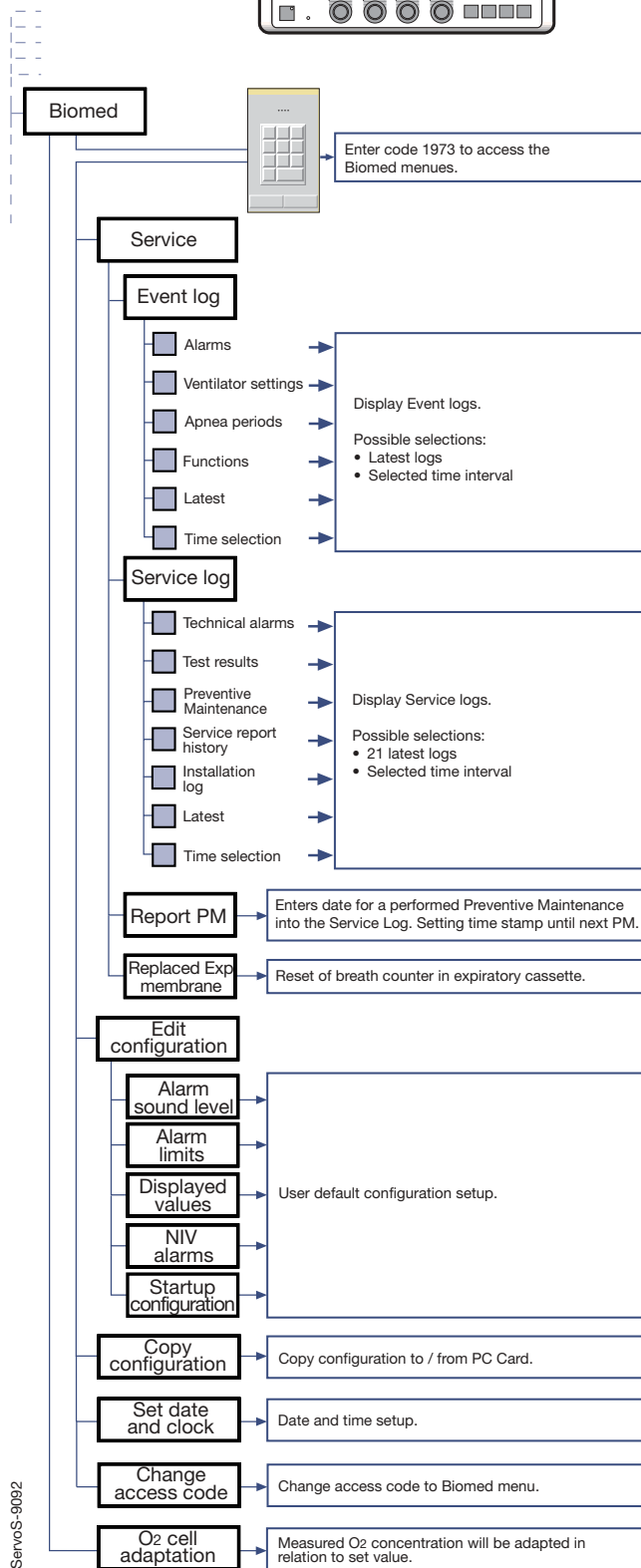

5

ServoS-9092



Replaced Exp membrane:

This button must be pressed when the Expiratory cassette membrane has been replaced. This will reset the operating capacity meter (breath counter) in the expiratory cassette.

**Edit configuration**

Available only in Standby mode.

Alarm sound level

Default alarm sound level can be changed in this window.

Alarm limits

Default invasive alarm limits can be changed in this window:

- Pressure – Upper alarm limit
- Minute Volume – Lower and Upper alarm limit
- Respiratory Rate – Lower and Upper alarm limit
- End Exp. Pressure – Lower and Upper alarm limit
- Apnea time – Upper alarm limit.

Default configuration regarding 'General' and 'Units' cannot be changed in this window. Access to the Field Service System (FSS) is required.

Displayed values

The Measured value boxes on the User Interface shows different parameters. Some of these parameters are fixed and some are selectable in this window.

NIV alarms

Default NIV alarms can be changed in this window:

- Pressure – Upper alarm limit
- Minute Volume – Lower and Upper alarm limit
- Respiratory Rate – Lower and Upper alarm limit
- End Exp. Pressure – Lower and Upper alarm limit

The alarms listed above, except Pressure alarm, can be permanently silenced in this window.

Default configuration regarding 'General' and 'Units' cannot be changed in this window. Access to the Field Service System (FSS) is required.

Startup configuration

Requires Software Version 3. Startup configuration can be changed in this window:

- Type of ventilation
- Volume setting
- Breath Cycle setting
- Pre-post oxygenation conc. above set O<sub>2</sub> conc.

**Copy configuration**

Available only in Standby mode.

Default user configuration can be copied to / from a PC Card.

Default configuration regarding 'General', 'Units' and 'Alarm limits' will be copied.

Useful when applying the same user configuration on a number of units.

**Set date and clock**

Available only in Standby mode.

Date and time setting can be changed in this window.

**Change access code**

Available only in Standby mode.

Access code to the 'Biomed' menu can be changed in this window.

**O<sub>2</sub> cell adaptation**

Available only during ventilation in units with O<sub>2</sub> cell.

Adjustment of the O<sub>2</sub> concentration reading.

Refer to the 'SERVO-s Ventilator System – User's Manual' for further information.

## Software installation

### General

- Before starting any SW Upgrade or Update, check:
  - Installed System SW version (see 'System SW version' in the Status / General window)
  - System SW version stored on the PC Card.

It is not recommended to install System SW with lower version number than already installed in the SERVO Ventilator System.
- After any installation, maintenance or service intervention in the SERVO-s, perform a 'Pre-use check' according to instructions in the 'SERVO-s Ventilator System – User's Manual'.

### Software information

There are two different intentions for software installation:

#### SW Update

A SW Update will install a new System SW version in the SERVO Ventilator System. SW Updates are not dependent on the serial number of the ventilator and will not alter the installed SW Options.

#### SW Upgrade

A SW Upgrade will change the function of the SERVO Ventilator System. A SW Upgrade is individually created for each ventilator and can only be installed on this ventilator. S/N of the ventilator must be stated when ordering a SW Upgrade.

#### SW Upgrade

Option Upgrade  
All System versions



Software Version  
System version V3.0 or higher

#### SW Update

SW Service Release  
System version V3.0 or higher

System SW Update  
System version V1.0 - V2.1

ServoS-9105

### Software delivery

SW Updates and SW Upgrades can be downloaded from the 'MCC SW Download' website or delivered via freight on a PC Card.

- SW Updates are not dependent on the S/N of the ventilator and can thus be installed on any unit.
- SW Upgrades are specific for each ventilator and can only be installed on this unit. SW Upgrades must thus be ordered and created in factory before they can be available on the website or delivered on a PC Card.

### Software installation procedure

Further information regarding the different softwares and the software installation procedure can be found in the 'SERVO-i / SERVO-s Software – Installation Instructions'.

## Field Service System

### General

- The Field Service System (FSS) is a software provided to facilitate troubleshooting, service and maintenance of the SERVO Ventilator System.
- To access the Field Service System, a Service card (PC Card) and an access code must be used. The access code is unique for each Service card.
- The Service card is personal and must not be handed-over to anyone else.
- It is only possible to access the Field Service System with the ventilator in Standby mode.
- The Field Service System must not be activated with a patient connected the ventilator.

### Field Service System functions

In the Field Service System, it is possible to:

- Display information regarding the ventilator including options and parts installed.
- Calibrate the internal barometer.
- Display service and event logs.
- Run complete or selected test sequences.
- Create and save service reports.
- Export selected logs to a PC Card.
- Create user default configurations.

Only personnel trained and authorized by MAQUET shall be permitted to perform installation, service or maintenance of the SERVO-s.



Make sure to prepare the SERVO-s properly before disassembling and assembling. Refer to section 'Hazard notices' in chapter 'Important'.

Any service or maintenance must be noted in a log book.

After any installation, maintenance or service intervention in the SERVO-s, perform a 'Pre-use check'. Refer to the 'SERVO-s Ventilator System – User's Manual' for details.

This product contains electronic and electrical components. Discard disposable, replaced and left-over parts in accordance with appropriate industrial and environmental standards.



## 6. Troubleshooting

General .....	6 - 2
Pre-use check .....	6 - 3
Technical error codes .....	6 - 11

Possible causes to malfunction not mentioned in the following troubleshooting guides are:

- The system has not been correctly assembled after cleaning, maintenance or service.
- Disconnection or bad connection in cable connectors, PC board connectors, and inter-connection boards.
- Disconnected or defective gas tubes.

These possible causes to malfunction must always be considered during troubleshooting.

### General

Before starting troubleshooting, try to eliminate all possibilities of operational errors. If the malfunction remains, use the troubleshooting guides below as well as the information in chapter 'Description of functions' to locate the faulty part. Perform actions step by step and check that the malfunction is eliminated.

When the fault is corrected, carry out a complete 'Pre-use check' as described in the 'SERVO-s Ventilator System – User's Manual'.

The troubleshooting guides below are focused only on technical problems. Information about clinical related problems can be found in the 'SERVO-s Ventilator System – User's Manual'.

For functionality enhancement, the latest released System SW version is always recommended.

The Information in this chapter applies to System version V3.1 (or higher).

## Pre-use check

The SERVO-s demands the user to start the automatic Pre-use check at every startup of the unit. It is also possible to select the Pre-use check via the Standby menu.

The 'SERVO-s Ventilator System – User's Manual' describes how to perform this Pre-use check. The Pre-use check-description on the following pages gives more detailed information about the Pre-use check. This information can be used e.g. during troubleshooting of the unit.

Some of the recommended actions described below refer to the Field Service System (FSS). The Service card is required to access the FSS. Troubleshooting can of course be performed without access to the FSS, but for some of the recommended actions, the FSS will make troubleshooting faster and easier.

Check if the fault remains after each performed service action. Re-run the complete Pre-use check or run the concerned test using the FSS.

Via the Standby menu it is possible to perform a separate Patient circuit test to evaluate circuit leakage and measure circuit compliance. This test does not replace the complete Pre-use check.

\* Text within brackets refers to the tested subsystem; BRE = Breathing, MON = Monitor, PAN = Panel.

Test	Test description *	Recommended action if the test fails
During system start-up.	Internal technical tests: <ul style="list-style-type: none"> <li>• SW check</li> <li>• Reading EEPROM</li> <li>• Checksum EEPROM</li> <li>• Panel button stuck test</li> <li>• Audio test.</li> </ul> (BRE + MON + PAN)	<ol style="list-style-type: none"> <li>1. Restart the unit. Do not touch the User Interface during system start-up. Interfering with the knobs, keys, touch screen, loudspeaker grid, etc, may affect the internal technical tests.</li> <li>2. Reinstall the System SW.</li> </ol>



### Start Pre-use check

Internal tests	Audio test. (MON + PAN)	If possible, check the 'Test results'-log in the 'More detailed' mode (FSS). If the audio test failed:
	Alarm output connector test. Performed only if this option is installed. (MON)	<ol style="list-style-type: none"> <li>1. Make sure that the Patient Unit main cover and the User Interface rear cover are correctly mounted. Otherwise the audio tests may fail.</li> <li>2. Check in the Test results-log (FSS) if it was the Panel test or the Monitoring test that failed:                             <ul style="list-style-type: none"> <li>• If the Monitoring test failed: Replace PC 1772 Monitoring.</li> <li>• If the Panel test failed: Replace the loudspeaker or PC 1777 Panel.</li> </ul> </li> </ol>
	Power failure test. (MON)	

Test	Test description *	Recommended action if the test fails
Internal tests (continued)		If the Alarm output connector test failed: <ol style="list-style-type: none"> <li>1. Replace PC 1862 DC/DC &amp; Standard Connectors.</li> <li>2. Replace PC 1772 Monitoring</li> </ol> If the power test failed: <ol style="list-style-type: none"> <li>1. Replace PC 1772 Monitoring.</li> </ol>
Barometer test	Checks that the barometric pressure measured by the internal barometer is within 630–1080 hPa.  Checks that the measured barometric pressure values differs less than 8 hPa between BRE and MON.  (BRE + MON)	Check the Barometric pressure value in the Status window:  If that value is within 630–1080 hPa: <ol style="list-style-type: none"> <li>1. Replace PC 1771 Control</li> <li>2. Replace PC 1772 Monitoring</li> <li>3. Replace PC 1784 Expiratory channel</li> <li>4. Replace the gas modules. Replace one gas module at a time:</li> </ol> If that value is outside 630–1080 hPa: <ol style="list-style-type: none"> <li>1. Replace PC 1772 Monitoring.</li> </ol>
Gas supply pressure test	Checks that the gas supply pressures (Air and O <sub>2</sub> ) measured by the internal gas supply pressure transducers are within 200–650 kPa (2.0–6.5 bar).  Checks that the measured supply gas pressure values differs less than 20 mbar between MON and BRE.  (BRE + MON)	<ol style="list-style-type: none"> <li>1. Check that the connected gas supply pressure (Air and O<sub>2</sub>) is within the specified range.</li> <li>2. Start the unit in a ventilation mode and check the alarms:                             <ul style="list-style-type: none"> <li>• If an Air supply pressure-alarm is activated, replace the Gas module Air.</li> <li>• If an O<sub>2</sub> supply pressure-alarm is activated, replace the Gas module O<sub>2</sub>.</li> </ul> </li> <li>3. Replace PC 1771 Control.</li> <li>4. Replace PC 1772 Monitoring.</li> </ol>



Test	Test description *	Recommended action if the test fails
Internal leakage test	<p>Checks the internal leakage, with test tube connected, using the inspiratory and expiratory pressure transducers.</p> <p>Checks that the leakage at 80 cm H<sub>2</sub>O is max. 10 ml/min.</p> <p>Checks that the measured pressure values differs less than 5 cm H<sub>2</sub>O between Insp. and Exp.</p> <p>(BRE)</p>	<p>If message 'Leakage' or 'Excessive leakage' appears:</p> <ol style="list-style-type: none"> <li>1. Check that the test tube is correctly connected.</li> <li>2. Check the expiratory cassette:                             <ul style="list-style-type: none"> <li>• Check that the cassette is correctly seated in the cassette compartment.</li> <li>• If possible, replace the expiratory cassette and check if the new cassette is accepted by the Pre-use check.</li> <li>• If the new cassette was accepted by the Pre-use check, the fault was located to the cassette. To repair the old cassette, check that the expiratory valve membrane is clean and correctly seated in the cassette. Replace the membrane if required.</li> </ul> </li> <li>3. Check that the pressure transducer tubes/filters are correctly mounted.</li> <li>4. Check the inspiratory section:                             <ul style="list-style-type: none"> <li>• Check that the inspiratory pipe is correctly mounted in the inspiratory section.</li> <li>• Check that the safety valve membrane is clean and correctly seated in the inspiratory pipe.</li> <li>• Check that the safety valve closes properly when the Pre-use check is started (distinct clicking sound from the valve). If the safety valve opens during this test, the opening pressure may not be correctly calibrated (see 'Safety valve test' below). Run the 'Safety valve test' and repeat the complete Pre-use check.</li> </ul> </li> </ol>



Test	Test description *	Recommended action if the test fails
Internal leakage test (continued)		<p>If message 'Pressure Transducer difference &gt; 5 cm H<sub>2</sub>O' appears:</p> <ol style="list-style-type: none"> <li>1. Check that the pressure transducer tubes and the inspiratory filter are correctly mounted.</li> <li>2. Check that both PC 1781 Pressure transducer (Insp. and Exp.) are correctly mounted.</li> <li>3. If the 'Pressure transducer test' also fails (see below), refer to the recommended actions if 'Pressure transducer test' failed.</li> </ol> <p>If message 'System volume too small' appears:</p> <ol style="list-style-type: none"> <li>1. Replace the gas modules. Replace one gas module at a time.</li> </ol> <p>If message 'System volume too large' appears:</p> <ol style="list-style-type: none"> <li>1. Check that the correct test tube is used during the Pre-use check.</li> <li>2. If the 'Flow transducer test' also fails (see below), replace the gas modules. Replace one gas module at a time.</li> <li>3. Refer to troubleshooting as described for 'Leakage' or 'Excessive leakage' above.</li> </ol>



Test	Test description *	Recommended action if the test fails
<p>Pressure transducer test</p>	<p>Calibrates and checks the inspiratory and expiratory pressure transducers.</p> <p>The new zero value for the pressure transducers may not differ more than <math>\pm 6</math> cm H<sub>2</sub>O from factory calibration.</p> <p>With the inspiratory pressure transducers used as a reference, a new gain factor is set for the expiratory pressure transducer. The new gain factor may not differ more than <math>\pm 5\%</math> from factory calibration.</p> <p>During this test, the different subsystems concerned are compared. The difference between the subsystems must not be more than <math>\pm 1</math> cm H<sub>2</sub>O at 60 cm H<sub>2</sub>O.</p> <p>Expiratory valve coil test. Measures offset and gain in the valve coil.</p> <p>(BRE + MON)</p>	<p>Check the 'Test results'-log in the 'More detailed' mode. (FSS)</p> <p>If 'Pressure transducer test' failed:</p> <ol style="list-style-type: none"> <li>1. Check the expiratory cassette:                             <ul style="list-style-type: none"> <li>• If possible, replace the expiratory cassette and check if the new cassette is accepted by the Pre-use check.</li> <li>• If the new cassette was accepted by the Pre-use check, the fault was located to the cassette. The fail with the old cassette may in this case be due to water collected at the pressure transducer filter inside the cassette. Dry the old cassette properly.</li> </ul> </li> <li>2. Check/replace PC 1781 Pressure transducer (Insp. and Exp.). To locate the faulty pressure transducer, replace one transducer at a time.</li> <li>3. Replace PC 1771 Control.</li> <li>4. Replace PC 1772 Monitoring.</li> </ol> <p>If 'Expiration valve test' failed:</p> <ol style="list-style-type: none"> <li>1. Check the expiratory cassette:                             <ul style="list-style-type: none"> <li>• If possible, replace the expiratory cassette and check if the new cassette is accepted by the Pre-use check.</li> <li>• If the new cassette was accepted by the Pre-use check, the fault was located to the cassette. To repair the old cassette, check that the expiratory valve membrane is clean and correctly seated in the cassette. Replace the membrane if required.</li> </ul> </li> <li>2. Replace the Expiratory valve coil.</li> </ol>



Test	Test description *	Recommended action if the test fails
Safety valve test	<p>Checks and if necessary adjusts the opening pressure for the safety valve to 117 ±3 cm H<sub>2</sub>O.</p> <p>Checks the hardware signals related to the safety valve functions.</p> <p>(BRE + MON)</p>	<ol style="list-style-type: none"> <li>1. Check the inspiratory section:                             <ul style="list-style-type: none"> <li>• Check that the inspiratory pipe is correctly mounted in inspiratory section.</li> <li>• Check that the safety valve membrane is clean and correctly seated in the inspiratory pipe.</li> </ul> </li> <li>2. Replace the safety valve pull magnet.</li> <li>3. Replace PC 1784 Expiratory channel.</li> <li>4. Replace PC 1772 Monitoring.</li> </ol>
O <sub>2</sub> cell/sensor test	<p>Calibrates and checks the O<sub>2</sub> Sensor/cell at 21% O<sub>2</sub> and 100% O<sub>2</sub>.</p> <p>Checks if the O<sub>2</sub> cell is worn out.</p> <p>As different gas mixtures are used during this test, calibration and check of O<sub>2</sub> Sensor/cell will not be performed if one gas is missing.</p> <p>The O<sub>2</sub> Sensor test requires 21% O<sub>2</sub> and 100% O<sub>2</sub>. If other gas mixtures are used (e.g. O<sub>2</sub> supply delivers 96% O<sub>2</sub> instead of 100%) the O<sub>2</sub> cell/sensor test may fail.</p> <p>(BRE + MON)</p>	<ol style="list-style-type: none"> <li>1. Check that the connected gas supply pressure (Air and O<sub>2</sub>) is within the specified range.</li> <li>2. Replace the O<sub>2</sub> Sensor/cell.</li> <li>3. Replace the gas modules. Replace one gas module at a time.</li> <li>4. Replace PC 1771 Control.</li> <li>5. Replace PC 1772 Monitoring.</li> </ol>

Test	Test description *	Recommended action if the test fails
Flow transducer test	<p>Checks the inspiratory flow transducer. Calibrates and checks the expiratory flow transducer.</p> <p>Calibrates at 60% O<sub>2</sub> and checks at 100% and 21% O<sub>2</sub>. As different gas mixtures are used during this test, calibration of the expiratory flow transducer will only be performed if both gases are connected. The check using the connected gas, (100% alt. 21% O<sub>2</sub>) will however be performed. The 'Flow transducer test' will pass if the result of this check corresponds to the old calibration factor from a previous Pre-use check. The same expiratory cassette must be used.</p> <p>The new calibration factor for the expiratory flow transducer may not differ more than -10% to +15% from factory calibration.</p> <p>During this test, the different subsystems concerned are compared. The difference between the subsystems must not be more than ±0.3 l/min.</p> <p>(BRE + MON)</p>	<ol style="list-style-type: none"> <li>1. Check that the connected gas supply pressure (Air and O<sub>2</sub>) is within the specified range.</li> <li>2. Check the expiratory cassette: <ul style="list-style-type: none"> <li>• Check that the cassette is correctly seated in the cassette compartment.</li> <li>• If possible, replace the expiratory cassette and check if the new cassette is accepted by the Pre-use check.</li> <li>• If the new cassette was accepted by the Pre-use check, the fault was located to the cassette. The fail with the old cassette may in this case be due to water collected inside the cassette. Dry the old cassette properly.</li> </ul> </li> <li>3. Replace the gas modules. Replace one gas module at a time.</li> <li>4. Replace PC 1785 Expiratory channel connector.</li> <li>5. Replace PC 1771 Control.</li> <li>6. Replace PC 1772 Monitoring.</li> <li>7. Replace PC 1784 Expiratory channel.</li> </ol>
Battery switch test	<p>Checks that the power supply switches to battery when mains power is disconnected.</p> <p>Checks that the power supply switches back to mains power when re-connected.</p> <p>This test will not be performed if:</p> <ul style="list-style-type: none"> <li>• Less than 10 min. backup time remains in the internal battery.</li> </ul> <p>(MON)</p>	<ol style="list-style-type: none"> <li>1. Check that the total remaining time for the internal battery is &gt;10 min. If not, allow the internal battery to charge and repeat the test.</li> <li>2. Replace PC1863 Power control.</li> <li>3. Replace the battery modules. Always replace both battery modules at the same time.</li> </ol>

Test	Test description *	Recommended action if the test fails
Patient circuit test	<p>Checks the patient circuit leakage, with patient tubing connected, using the inspiratory and expiratory pressure transducers.</p> <p>Checks that the leakage at 50 cm H<sub>2</sub>O is max. 80 ml/min.</p> <p>Will allow the system to calculate a compensation for circuit compliance (if the leakage requirements are met). (BRE)</p>	<p>If the internal leakage test (see above) has passed, the leakage is to be located to the patient circuit. Check for leakage or replace the patient circuit.</p>
Alarm state test	<p>Checks that no Technical error alarms are active during the Pre-use check. (MON)</p>	<p>Refer to section regarding Technical error alarms for further information.</p>
External alarm system test	<p>If the option Alarm Output Connector is enabled, the user can test the external alarm system.</p> <p>The external alarm output signal is activated and the user must verify the external alarm.</p>	<ol style="list-style-type: none"> <li>1. Check the external alarm system.</li> <li>2. Replace PC 1862 DC/DC &amp; Standard Connectors.</li> </ol> <p>The result of the test does not affect the outcome of the Pre-use check</p>

6

Test	Test description *	Recommended action if the test fails
Separate Patient circuit test.	<p>This test separately performs the Patient circuit test as described above.</p>	<p>See above</p>

## Technical error codes

The table below shows recommended actions in case of Technical error alarms.

Some of the Error codes are intended only for R&D, not for field service. If so, the text 'N/A' is stated in the 'Recommended action'-column.

Error code	Error message / Possible cause	Recommended action
<b>Monitoring</b>		
1	POWER_FAILURE_MINUS_12_VOLTS_TOO_LOW (i.e. < -13.2 V)	1. Replace PC 1862 DC/DC & Standard Connectors.
2	POWER_FAILURE_MINUS_12_VOLTS_TOO_HIGH (i.e. > -10.8 V)	1. Check status of external battery (if connected). 2. Replace PC 1862 DC/DC & Standard Connectors. 3. Replace PC 1863 Power control.
3	POWER_FAILURE_12_VOLTS_TOO_LOW	1. Check status of external battery (if connected). 2. Replace PC 1862 DC/DC & Standard Connectors. 3. Replace PC 1863 Power control.
4	POWER_FAILURE_12_VOLTS_TOO_HIGH	1. Replace PC 1862 DC/DC & Standard Connectors.
5	POWER_FAILURE_24_VOLTS_TOO_LOW	1. Replace PC 1862 DC/DC & Standard Connectors. 2. Replace the gas modules. Replace one gas module at a time and check that this technical error code will not appear.
6	POWER_FAILURE_24_VOLTS_TOO_HIGH	1. Replace PC 1862 DC/DC & Standard Connectors.
7	INSP_VALVE_RANGE_ERR	1. Replace PC 1771 Control. 2. Replace PC 1772 Monitoring. 3. Replace the gas modules. Replace one gas module at a time and check that this technical error code will not appear.
8	TECH_ERR_INSP_PAUSE_HOLD_TIME_EXCEEDED	1. Replace PC 1771 Control.
9	TECH_ERR_EXP_PAUSE_HOLD_TIME_EXCEEDED	1. Replace PC 1771 Control.

Error code	Error message / Possible cause	Recommended action
10	VALVES_DISABLED	<ol style="list-style-type: none"> <li>1. Replace PC 1784 Expiratory channel.</li> <li>2. Replace PC 1771 Control.</li> <li>3. Replace PC 1862 DC/DC &amp; Standard Connectors.</li> <li>4. Replace PC 1772 Monitoring.</li> </ol>
11	SAFETY_VALVE_OPEN	<ol style="list-style-type: none"> <li>1. Check inspiratory channel.</li> <li>2. Replace safety valve pull magnet.</li> <li>3. Replace PC 1784 Expiratory channel.</li> </ol>
12	BRE_NODE_DISCON	<ol style="list-style-type: none"> <li>1. Replace PC 1771 Control.</li> <li>2. Replace PC 1862 DC/DC &amp; Standard Connectors.</li> </ol>
13	BRE_NODEID_CONFLICT	N/A
14	PANEL_NODE_DISCON	<ol style="list-style-type: none"> <li>1. Check the control cable</li> <li>2. Replace PC 1777 Panel.</li> <li>3. Replace PC 1862 DC/DC &amp; Standard Connectors.</li> </ol> <p>Note: This error indicates communication failure between PC 1777 and PC 1772 and the error code will thus not be shown on the display (but will be logged).</p>
15	PANEL_NODEID_CONFLICT	N/A
16	EXP_FLOW_MTR_NODE_DISCON	<ol style="list-style-type: none"> <li>1. Replace PC 1784 Expiratory channel.</li> </ol>
17	EXP_FLOW_MTR_NODEID_CONFLICT	N/A
18	N/A	N/A
19	N/A	N/A
20	N/A	N/A
21	N/A	N/A
22	BUZZER_SILENCER	<ol style="list-style-type: none"> <li>1. Replace PC 1772 Monitoring.</li> </ol>
23	N/A	N/A
24	BACKUP_CAP_ERR_MON	<ol style="list-style-type: none"> <li>1. Replace PC 1772 Monitoring</li> </ol>

Error code	Error message / Possible cause	Recommended action
25	TECH_MON_DEVICE_COMM_ERR	Depending on ID #. If repeated, replace parts as follows: 0: Report to MCC HSC for further information. 1: PC 1772 Monitoring. 2: PC 1863 Power control. 3: PC 1862 DC/DC & Standard Connectors. 4: PC 1781 Inspiratory pressure transducer. 5: PC 1781 Expiratory pressure transducer. 6: O2 Sensor/cell or O2 cell Sensor/cable or PC 1772 Monitoring. 32: PC 1784 Expiratory channel or PC 1772 Monitoring. 33: Gas module Air or PC 1772 Monitoring. 34: Gas module O2 or PC 1772 Monitoring. 35: PC 1772 Monitoring. 256: PC 1771 Control. 512: PC 1777 Panel. 784: N/A
27	TECH_ERR_BUZZER_FAILURE	1. Replace PC 1772 Monitoring. Note: If the Patient Unit main cover is removed, this error may be activated.
28	PANEL_AUDIO_FAIL	1. Replace the loudspeaker. 2. Replace PC 1777 Panel. Note: If the User Interface rear cover is removed, this error may be activated.
29	LITHIUM_BATTERY_LOW	1. Replace battery on PC 1772 Monitoring.
32	ALARM_ID_MISMATCH	N/A
33	BRE_NODE_CONNECT_TIMEOUT	1. Replace PC 1771 Control.
34	PANEL_NODE_CONNECT_TIMEOUT	1. Check the control cable. 2. Replace PC 1777 Panel. 3. Replace PC 1862 DC/DC & Standard Connectors. Note: This error indicates communication failure between PC 1777 and PC 1772 and the error code will thus not be shown on the display (but will be logged).

Error code	Error message / Possible cause	Recommended action
35	EXP_FLOW_MTR_NODE_CONNECT_TIME-OUT	1. Replace PC 1784 Expiratory channel.
36	N/A	N/A
37	EXP_FLOW_MTR_RANGE_ERR	N/A
38	BARO_UPPER_LIMIT_EXCEEDED	1. Check/calibrate barometer. 2. Replace PC 1772 Monitoring.
39	BARO_LOWER_LIMIT_EXCEEDED	1. Check/calibrate barometer. 2. Replace PC 1772 Monitoring. Note: This alarm will be activated if the ambient pressure is below 650 hPa, e.g. on a high altitude.
40	INVALID_METRIC	N/A
41	REAL_TIME_CLOCK_ERR	1. Replace PC 1772 Monitoring.
42	PERSISTENT_CHECKSUM_ERR	1. Restart the unit. 2. Replace PC 1772 Monitoring (if not Error code 29).
43	POWER_COMM_ERR	1. Replace the battery modules. Always replace both battery modules at the same time. 2. Replace PC 1863 Power control. 3. Replace PC 1772 Monitoring.
44	ALARM_LIM_XOR_ERR	1. Restart the unit. 2. Replace PC 1772 Monitoring (if not Error code 29).
45	ABNORMAL_SHUTDOWN	1. Restart the unit and run a Pre-use check. 2. Replace PC 1772 Monitoring.
46	REMOTE_ALARM_ERR	1. Replace PC 1862 DC/DC & Standard Connectors. 2. Replace PC 1772 Monitoring.
47	FIXED_BATTERY_MISSING	1. Check that the internal battery modules are properly connected. 2. Replace the battery modules. Always replace both battery modules at the same times 3. Replace PC 1863 Power control. 4. Replace PC 1772 Monitoring.
48	PRE_OXYGEN_PHASE_TOO_LONG	1. Replace PC 1771 Control.
49	DISCONNECT_PHASE_TOO_LONG	1. Replace PC 1771 Control.
50	BACKPLANE_EEPROM_INVALID	1. Replace PC 1772 Monitoring. 2. Replace PC 1860 Main back-plane.



Error code	Error message / Possible cause	Recommended action
<b>Breathing</b>		
10001	BATTERY_MIN_VOLTAGE	1. Replace battery on PC 1771 Control.
10002	BRE_I2C_ERROR	1. Replace PC 1771 Control.
10003	BRE_FATAL_MEMORY_ERROR	1. Restart the unit. 2. Replace PC 1771 Control.

<b>Panel</b>		
20001	PANEL_DEVICE_ERROR	1. Replace PC 1777 Panel.
20002	PANEL_BACKLIGHT_BROKEN  This error message may also be logged immediately before the 'No battery capacity' alarm when the unit is running in battery mode.	<p>If the display is lit (and the error code is shown on the display):</p> <p>1. Replace PC 1777 Panel.</p> <p>If the display is not lit (the display is dark):</p> <p>1. Replace backlight lamps. 2. Replace PC board Backlight Inverter.</p> <p>Note: If one of the lamps is broken, the other lamp will automatically be switched off. Thus, with a failure on a backlight lamp, or likely also on PC board Backlight Inverter, the User Interface display will become dark. This error code will in such case not be possible to see (but will be logged).</p>
20003	PANEL_BUTTON_STUCK	<p>1. Restart the unit. Do not touch the User Interface during system startup. Interfering with the knobs, keys, touch screen, loudspeaker grid, etc, may affect the internal technical tests.</p> <p>2. Check the user interface membrane buttons (FSS).</p> <p>3. Replace the touch screen.</p> <p>4. Replace PC 1777 Panel.</p>
20004	PANEL_AUDIO_FAILED	<p>1. Restart the unit. Do not touch the User Interface during system startup. Interfering with the knobs, keys, touch screen, loudspeaker grid, etc, may affect the internal technical tests.</p> <p>2. Replace the loudspeaker.</p> <p>3. Replace PC 1777 Panel.</p>
20005	PANEL_PERSISTENT_CHECKSUM_ERR	1. Replace PC 1772 Monitoring.

Error code	Error message / Possible cause	Recommended action
Restart ventilator	Communication error between PC 1777 Panel and PC 1772 Monitoring.	<ol style="list-style-type: none"> <li>1. Restart the ventilator and perform a Pre-use check.</li> <li>2. Check the Control cable that connects the Patient Unit with the User Interface.</li> <li>3. Replace PC 1862 DC/DC &amp; Standard connectors.</li> <li>4. Replace PC 1772 Monitoring.</li> </ol>

### Expiratory Flow Meter

40001	<p>Technical error in Exp flow meter.</p> <p>If the technical alarm 'Expiration flow meter PC 1784 60 V underrange' is logged together with error code 40001, see recommended action for this specific fault.</p>	<ol style="list-style-type: none"> <li>1. Replace the expiratory cassette.</li> <li>2. Replace PC 1784 Expiratory channel.</li> <li>3. Replace PC 1785 Expiratory channel connector.</li> </ol> <p>If technical alarm 'Expiration flow meter PC 1784 60 V underrange' is present:</p> <ol style="list-style-type: none"> <li>1. Replace PC 1862 DC/DC &amp; Standard Connectors.</li> </ol>
-------	---	---

### Expiratory cassette

Technical error in Expiratory cassette	<p>Technical error in Expiratory cassette or in the communication with the cassette.</p> <p>If the technical alarm 'Expiration flow meter Exp. cassette power failure' is logged together with error code 'Technical error in Expiratory cassette', see recommended action for this specific fault.</p>	<ol style="list-style-type: none"> <li>5. Replace the expiratory cassette.</li> <li>6. Replace PC 1785 Expiratory channel connector.</li> <li>7. Replace PC 1784 Expiratory channel.</li> </ol> <p>If technical alarm 'Expiration flow meter Exp. cassette power failure' is present:</p> <ol style="list-style-type: none"> <li>1. Replace PC 1862 DC/DC &amp; Standard Connectors.</li> </ol>
--	---	---

Only personnel trained and authorized by MAQUET shall be permitted to perform installation, service or maintenance of the SERVO-s.



Make sure to prepare the SERVO-s properly before disassembling and assembling. Refer to section 'Hazard notices' in chapter 'Important'.

Any service or maintenance must be noted in a log book.

After any installation, maintenance or service intervention in the SERVO-s, perform a 'Pre-use check'. Refer to the 'SERVO-s Ventilator System – User's Manual' for details.

This product contains electronic and electrical components. Discard disposable, replaced and left-over parts in accordance with appropriate industrial and environmental standards.



## 7. Preventive maintenance

- General ..... 7 - 2
- Preparations ..... 7 - 2
- Equipment ..... 7 - 2
- Preventive maintenance ..... 7 - 3
  - Maintenance kit, 5,000 hours ..... 7 - 3
  - Performing the Preventive maintenance ..... 7 - 3

## General

- A 'Preventive maintenance' must be performed at least once every year as long as the unit is not used more than normal. Normal operation is estimated to correspond to approx. 5,000 hours of operation.
- The life span for the Battery module is calculated to two and a half year from manufacturing date. Normal time for logistics and storage are included in this calculation. The calculation corresponds thus to an estimated operational time of two years. Manufacturing date (year-week) is printed on the battery label.
- The internal Lithium batteries on PC 1771 and PC 1772 shall be replaced every five years.
- It is recommended that a regular cleaning and an extended cleaning of the inspiratory channel should be performed before carrying out 'Preventive maintenance'. Refer to instructions in the User's Manual.
- In some parts of the Preventive maintenance, as described in this chapter, access to the Field Service System (FSS) is required.
- Some optional equipment used with the SERVO-s, but not covered by this Service Manual, may also demand maintenance actions. Refer to the optional equipments documentation. Example on such optional equipment are:
  - Humidifier
  - Compressor Mini.

## Preparations

- Make sure that the SERVO-s works properly before performing any maintenance.
- Check if there are any unexpected 'Technical alarms' in the 'Service log' available via the 'Biomed menu'. 'Technical alarms' are available also via the Field Service System (FSS).
- Set the On/Off switch on the User Interface to Off.
- Disconnect the mains power cable.
- Disconnect the gas supplies (wall and/or cylinder).
- Remove patient tubing.
- If fitted, remove bacteria filter from the expiratory inlet.

## Equipment

- Standard service tools.
- Barometer (or information about the actual barometric pressure).
- Access to the Field Service System (FSS). Recommended but not required.
- Preventive maintenance kit containing all parts needed during the maintenance.

## Preventive maintenance

### Maintenance kit, 5,000 hours

Only original parts from the manufacturer must be used. Spare parts and maintenance kits can be ordered from your local MAQUET representative.

When performing this maintenance, a 'Maintenance kit, 5,000 hours' should be used.

The following parts shall be replaced and they are included in the 'Maintenance kit, 5,000 hours':

- A. Filters for the gas modules
- B. Nozzle units for the gas modules
- C. Bacteria filter for the inspiratory pressure transducer
- D. Bacteria filter for the O<sub>2</sub> cell

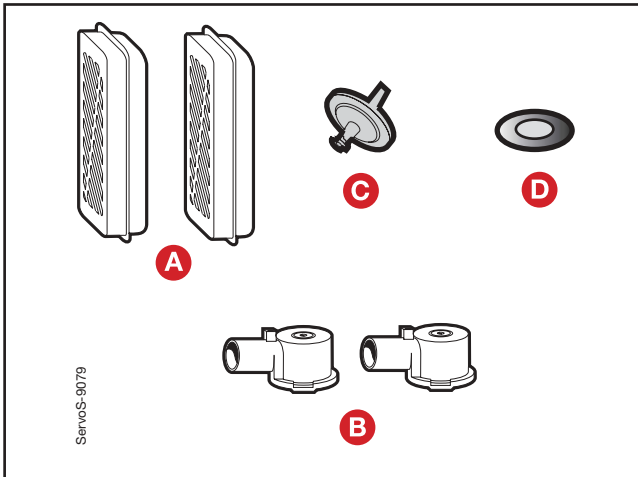

### Performing the Preventive maintenance

- Disassembling and assembling of the unit is required when replacing parts included in the 'Maintenance kit, 5,000 hours'. If not stated otherwise, refer to chapter 'Disassembling and assembling' for instructions.
- The letters A – D in the text below refers to the description of the Maintenance kit above.
- Prepare the unit as described in section 'Preparations' above in this chapter.

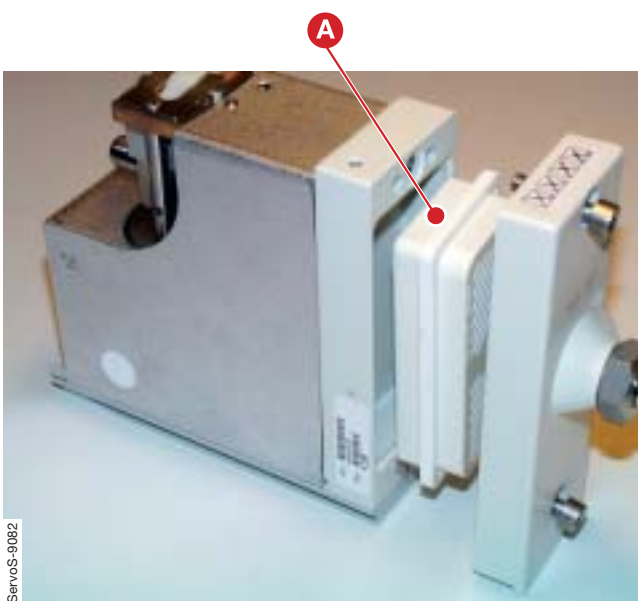

### Gas modules

- A. Replace filters in the gas modules. When replacing filter, move the rubber seal from the old to the new filter.

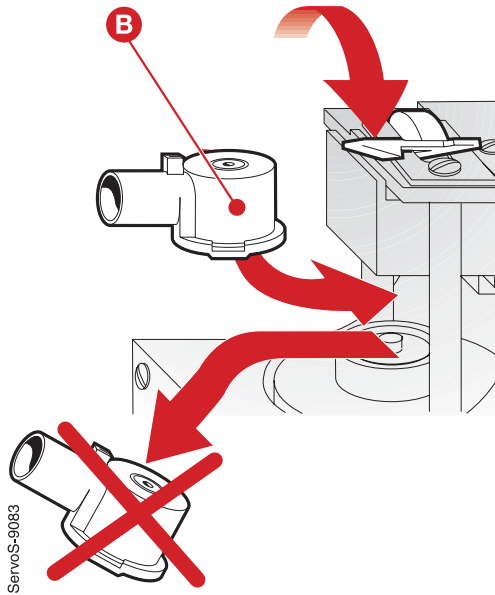

B. Replace plastic nozzle units in the gas modules.

After replacement of plastic nozzle units, wait 10 minutes before connecting pressure to the gas modules.



**Inspiratory pressure transducer filter**

C. Replace the filter for the inspiratory pressure transducer. Make sure that the filter is correctly seated into the rubber ring.

Refer to instructions in the 'SERVO-s Ventilator System – User's Manual'.

**Note:** This filter may already be replaced as a part of the 'Extended cleaning of Inspiratory channel' performed in combination with the Preventive maintenance.

7



**Bacteria filter for O<sub>2</sub> cell**

D. Replace the bacteria filter for the O<sub>2</sub> cell (if applicable).

Refer to instructions in the 'SERVO-s Ventilator System – User's manual', chapter 'Maintenance'.

**Note:** This filter is not used on the O<sub>2</sub> Sensor.



### Internal fan filter

- Remove the internal fan filter (1).
- Check if the filter is damaged. Replace damaged filter.
- If not damaged, clean the filter. The filter can be rinsed in water. Shake out and make sure that the filter is free from excess water.
- Mount the new/cleaned filter.

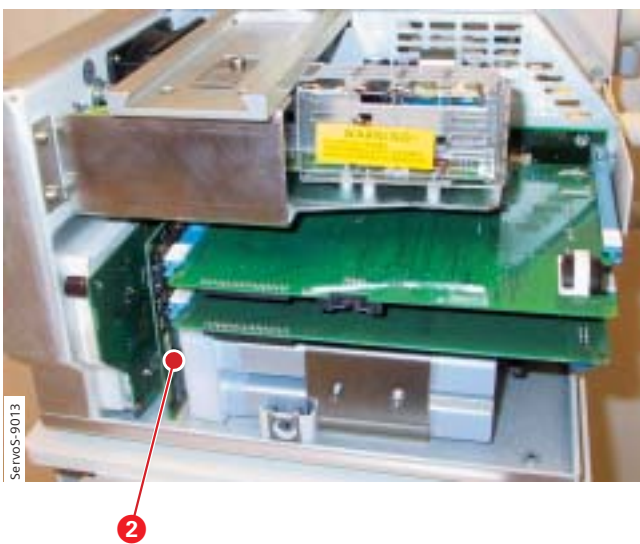

### Internal fan

- Connect the mains power cable.
- Set the On/Off switch to Standby.
- The temperatur sensor controlling the Internal fan is mounted on PC 1863 Power control. Carefully warm-up PC 1863 (2) and check that the Internal fan starts. Use e.g. a light bulb or a heat fan to warm the PC board.

The Internal fan will start at approx.:

33 °C (91 °F) with half effect

43 °C (109 °F) with full effect.

**Note:** The temperature must not exceed 70 °C (158 °F).

It is also possible to check the Internal fan by running the unit in a ventilation mode and wait until the Internal fan starts. If this test method is used, the main cover must be mounted in order to raise the temperature inside the compartment.

### Expiratory cassette

- Remaining operating capacity (in %) for the membrane can be shown in the 'Status' window. Select Status / Exp. cassette to check 'Remaining membrane capacity'.
- When this capacity limit is passed or if the membrane for some reason has become defective, it must be replaced. Refer to instructions in chapter 'Disassembling and assembling'.
- The operating capacity meter must be reset after replacement of the membrane. To access the reset button, select Menu / Biomed / Service.

## User Interface

- Check the touch screen readability:
  - Transparency
  - Surface
  - Brightness (backlight). Estimated lifetime (with acceptable brightness level) for the lamps is 30,000 hours. Using the Field Service System (FSS), a time meter for the lamps can be shown. The time meter must be reset after replacement of the lamps.
- Check if pixels on the touch screen are defective. Open the Status window. A few defective pixels can be accepted. Check that defective pixels are not concentrated to a small area thus reducing the readability in this area. FSS is recommended but not required.
- Perform the checks listed below and make sure that the software responds to these actions. FSS is recommended but not required.
  - Check the touch screen functions. Press buttons on different parts of the touch screen.
  - Check the Main Rotary Dial. Turn and press the Main Rotary Dial.
  - Check the Direct Access Knobs. Turn all Direct Access Knobs.
  - Check the membrane buttons. Press all membrane buttons.

## Barometric pressure

- Select Status / General on the User Interface. Check that the Barometric pressure value shown on the User Interface corresponds to the actual Barometric pressure value at the local site. The value shown on the User Interface may not differ more than  $\pm 5\%$  from the actual barometric pressure.
- If the value shown on the User Interface differs more than  $\pm 5\%$  from the actual barometric pressure, the barometer in SERVO-s must be calibrated. FSS is required.

## Gas supply pressure transducers

- Connect the gas supplies (Air and O<sub>2</sub>).
- Select Status / General on the User Interface.
- Disconnect the gas supply, one gas at the time.
- Check that the corresponding supply pressure value in the 'Status'-window drops.

## Battery modules

System SW version V2.01.00 (or higher) includes an advanced monitoring of the battery status. The System SW will, among others, monitor:

- Expiry date. The life span for the Battery module is calculated to two and a half year from manufacturing date.
- If the operational capacity is too poor for continued usage.

In both cases, battery replacement information will be shown on the User Interface.

Select 'Status / Batteries' on the User Interface to check battery status. For further information, refer to chapter 'Service procedures', section 'Battery modules'.

**Note:** Replace both batteries at the same time.

## Lithium batteries

- Check manufacturing date for the lithium batteries mounted onto PC 1771 and PC 1772. The batteries must be replaced after 5 years. Replacement is described in chapter 'Service procedures'.

## Safety inspection

- Make a visual inspection of the SERVO-s for external defects or damages. Replace defective or damaged parts.
- Check the mains power cable and control cable and their connections for damage.
- Perform a leakage current test. The leakage current test is a standard procedure regulated by IEC 60 601-1 or corresponding national standards. Allowable values and test methods are defined in the standard. The use of a leakage tester, e. g. Bender Safety Tester 601/751 or equivalent is recommended.
- Check that a 'SERVO-s Ventilator System – User's Manual' corresponding to the installed System version is present. Also check that operating manuals for all optional equipment connected to the SERVO-s are present.

## Completing the Preventive maintenance

- Perform a 'Pre-use check'. Refer to the 'SERVO-s Ventilator System – User's Manual'.
- Perform 'Function checks' on the optional equipments connected to the SERVO-s. Refer to the operating manuals for these optional equipments.
- Reset the Preventive maintenance time meter. Use the reset button (select Menu / Biomed / Service / Report PM) or use the FSS. Also note in a SERVO-s log book that a Preventive maintenance has been performed.



Only personnel trained and authorized by MAQUET shall be permitted to perform installation, service or maintenance of the SERVO-s.



Make sure to prepare the SERVO-s properly before disassembling and assembling. Refer to section 'Hazard notices' in chapter 'Important'.

Any service or maintenance must be noted in a log book.

After any installation, maintenance or service intervention in the SERVO-s, perform a 'Pre-use check'. Refer to the 'SERVO-s Ventilator System – User's Manual' for details.

This product contains electronic and electrical components. Discard disposable, replaced and left-over parts in accordance with appropriate industrial and environmental standards.

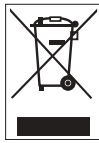

## 8. Index

Alphabetic index ..... 8 - 2

**A**

AC/DC Converter 2-7, 3-10, 4-16  
 Aeroneb Pro 2-3  
 Alarm output connector 2-3, 2-6, 3-12, 10-2  
 Assembling guidelines 4-2

**B**

Backlight Inverter 2-5, 3-3, 4-3, 4-6  
 Backlight lamps 2-5, 3-3, 4-3, 4-9  
 Bacteria filter for O<sub>2</sub> cell 7-4  
 Barometric pressure 7-6  
 Battery modules 2-7, 3-11, 4-16, 5-2, 7-6  
 Biomed key 5-4  
 Breathing SW 2-9

**C**

Cable reel 2-4  
 Change access code 5-5  
 Compressor Mini 2-3  
 Connector muff 2-7, 3-4, 4-15  
 Control cable 2-4, 3-10, 4-22  
 Control cable connector 2-6, 10-2  
 Copy configuration 5-5

**D**

Direct access controls/knobs 2-4, 2-5  
 Display with touch screen 2-4

**E**

EEPROM 3-2  
 Edit configuration 5-5  
 Environmental declaration 1-6  
 Equipotentiality terminal 2-6  
 ESD protection 1-4, 4-2  
 Expiratory cassette 2-8, 3-6, 6-16, 7-5  
 Expiratory cassette membrane 4-21  
 Expiratory inlet 2-6, 2-8  
 Expiratory one-way valve 2-8  
 Expiratory outlet 2-6  
 Expiratory section 3-6  
 Expiratory valve coil 2-8, 4-20  
 External +12 V DC supply 2-6, 10-2

**F**

Field service system (FSS) 5-6  
 Fixed keys 2-4  
 Fixed keys label 4-10  
 Flash memory 3-2  
 Functional check 1-5  
 Functional main blocks diagram 10-3

Fuse F1 2-6, 3-10  
 Fuse F11 2-6, 3-10  
 Fuse F12 2-6, 3-10

**G**

Gas cylinder restrainer 2-3  
 Gas inlet 2-6, 3-4  
 Gas modules 2-6, 3-3, 4-15, 7-3  
 Gas supply pressure transducers 7-6

**H**

Handling PC boards 4-2  
 Hazard notices 1-4  
 Heating foil 2-8, 3-7  
 Humidifier holder 2-3

**I**

Inspiratory channel 4-18  
 Inspiratory outlet 2-6, 3-5  
 Inspiratory pipe 2-7, 3-4, 4-15  
 Inspiratory pressure transducer filter 7-4  
 Inspiratory pressure transducer tube 2-7, 3-5  
 Inspiratory section 3-3  
 Installation 1-5  
 Installation Instructions 1-4  
 Internal fan 2-6, 2-7, 3-11, 4-18, 7-5  
 Internal fan filter 7-5

**L**

Label strips 4-10  
 Lithium batteries 1-5, 5-3, 7-2, 7-6  
 Locking arm 2-4  
 Loudspeaker 2-5, 3-2  
 Loudspeaker booster kit 2-3, 3-12  
 Loudspeaker grid 2-4  
 Luminescence detector 2-4

**M**

Main blocks diagram 10-3  
 Main cover 4-14  
 Main rotary dial 2-4, 2-5  
 Main units 2-2  
 Mains indicator 2-4  
 Mains inlet 3-9  
 Mains supply connector 2-6  
 Maintenance kit 5,000 hours 7-3  
 Memory types 3-2  
 Menu key 5-4  
 Mobile cart 2-3  
 Monitoring SW 2-9

**N**

N26 connector 9-2  
 N28 connector 9-2  
 N29 connector 9-2  
 N70 connector 9-2  
 Non-volatile memory 3-2

**O**

O2 cell 2-7, 3-5  
 O2 cell adaption 5-5  
 O2 Sensor 2-7, 3-5  
 On/Off switch 2-4, 3-2, 4-3, 4-4  
 On/Off switch cover 2-4, 3-2, 4-3, 4-4  
 Optional equipment 2-3

**P**

P63 connector 10-2  
 Panel SW 2-9  
 Patient Unit 2-2, 2-6, 3-3, 4-14, 4-15  
 PC 1771 Control 2-7, 3-8, 4-2, 4-16, 5-3  
 PC 1772 Monitoring 2-7, 3-9, 4-2, 4-16, 5-3  
 PC 1777 Panel 2-5, 3-2, 4-2, 4-3, 4-4  
 PC 1781 Expiratory pressure transducer 2-8, 3-8  
 PC 1781 Inspiratory pressure transducer 2-8, 3-8  
 PC 1784 Expiratory channel 2-8, 3-9, 4-2, 4-19  
 PC 1785 Expiratory channel connector 2-8, 3-8, 4-20  
 PC 1860 Main back-plane 2-7, 3-8, 4-17  
 PC 1861 Pneumatic back-plane 2-7, 3-6, 4-19  
 PC 1862 DC/DC & Standard con. 2-7, 3-10, 4-17  
 PC 1863 Power control 2-7, 3-10, 4-17  
 PC board Backlight inverter 2-5, 3-3, 4-3, 4-6  
 PC card 4-2  
 PC card slot 2-4  
 Power supply 3-9  
 Pressure transducers 3-8  
 Pre-use check 6-3  
 Preventive maintenance 7-3

**R**

RAM 3-2  
 Rear cover 4-3  
 Replacing PC boards 4-2  
 RS232 2-6, 10-2

**S**

Safety inspection 7-6  
 Safety valve 2-7, 3-6, 4-18  
 Safety valve membrane 4-18  
 Serial number label 1-4, 2-4, 2-6  
 Serial port 2-6  
 Service card 5-6

Service connector 2-4  
 Service contract 1-4  
 Set date and clock 5-5  
 Shelf base 2-3  
 Side cover 4-14  
 Software information 5-6  
 Software installation 5-6  
 Software structure 2-9  
 Spare parts information 1-4  
 Special function keys 2-4, 4-12  
 Special waste 1-4  
 Standard connectors 10-2  
 Standby indicator 2-4  
 Start/Stop/Standby ventilation key 2-4  
 Support Arm 176/177 2-3  
 Support plate 4-3  
 SW Update 5-6  
 SW Upgrade 5-6  
 Symbols used in this manual 1-4  
 System ID 2-9, 4-17  
 System SW 3-2, 4-2, 5-6  
 System version 1-4

**T**

Technical error codes 6-11  
 Technical training 1-4  
 Temperature sensor 3-9, 3-10  
 TFT Display 2-5, 3-3, 4-7  
 Threadlocking adhesives 4-2  
 Tightening torque 4-2  
 Touch screen incl. frame 2-5, 3-3, 4-3, 4-10

**U**

Ultrasonic flowmeter 2-8, 3-7  
 User Interface 2-2, 2-4, 3-2, 4-3, 7-6  
 User Interface controls 3-2  
 User interface panel cover 2-3  
 User's Manual 1-4

**W**

Waterbag pole 2-3



Only personnel trained and authorized by MAQUET shall be permitted to perform installation, service or maintenance of the SERVO-s.



Make sure to prepare the SERVO-s properly before disassembling and assembling. Refer to section 'Hazard notices' in chapter 'Important'.

Any service or maintenance must be noted in a log book.

After any installation, maintenance or service intervention in the SERVO-s, perform a 'Pre-use check'. Refer to the 'SERVO-s Ventilator System – User's Manual' for details.

This product contains electronic and electrical components. Discard disposable, replaced and left-over parts in accordance with appropriate industrial and environmental standards.

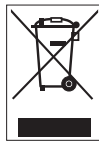

## 9. Service Manual revision history

Revision 01 .....	9 - 2
Revision 02 .....	9 - 4

## Revision 01

### Revision history table – Revision 01

In the table below, the following keywords are used in 'Comment' column:

- **Added.** Information added to the manual e.g. due to new functionality.
- **Changed.** Information changed in the manual e.g. due to changed functionality.
- **Corrected.** Corrections made due to printing errors or lack of information in the previous version of the manual.

Page	Section	Comment
1-4	Symbols used in this manual	Texts corrected.
1-5	Service	Battery module replacement interval changed. Texts regarding worn-out batteries and other disposable parts corrected.
1-6	Environmental declaration	Battery modules information corrected.
1-7	Articles of consumption	Item 6 and 7; replacement interval changed.
2-3	Descriptions of optional equipment	Information regarding Aeroneb Pro added.
2-4	User Interface	User Interface Type 2 information added.
2-6	Patient Unit	Serial number information corrected.
2-8	Expiratory cassette	PC 1786 information corrected.
2-9	SERVO-s software structure	SW Service Release information added. Trend information added.
3-2	Memory types used in SERVO-s	SW Service Release information added. Trend information added.
3-2	User Interface	User Interface Type 2 information added.
3-2	PC 1777 Panel	PC 1777 Type 2 information added.
3-2	Loudspeaker	Loudspeaker booster kit information added.
3-3	Backlight Inverter	Backlight Inverter Type 2 information added.
3-3	Touch screen including frame	Touch screen including frame Type 2 information added.
3-3	TFT Display with Backlight	TFT Display with Backlight Type 2 information added.
3-6	Expiratory cassette	Cassette design information changed Q1 2005.
3-8	PC 1784 Expiratory channel	Thermistor information corrected.
3-9	PC 1772 Monitoring	Trend information added.
3-9	Power supply	Internal DC supply voltage and Power supply selection information corrected.
3-9	PC 1862 DC/DC & Standard connectors	N26 information regarding alarm corrected.
3-10	PC 1862 DC/DC & Standard connectors	P63 information regarding Alarm output connector corrected.

3-10	Battery modules	Battery module functional description changed.
3-10	Control cable	Connect/disconnect information corrected.
4-3	User Interface	User Interface Type 2 information added.
4-4	PC 1777 Panel	PC 1777 Type 2 information added.
4-5	Replacement of PC 1777 Type 1	New spare part kit, assembling information added.
4-6	Backlight Inverter	Backlight Inverter Type 2 information added.
4-7	TFT Display	TFT Display Type 2 information added.
4-8		
4-9	Backlight lamps	Backlight lamps Type 2 information added.
4-14	Battery modules	Slot number information corrected.
4-19	Expiratory cassette membrane	Changed spare part (metal washer), assembling information changed.
4-20	Control cable	Connect/disconnect information corrected.
5-2	Battery modules	Battery module service procedure changed.
5-4	Using the Menu and Biomed key	Minor changes due to System version 3.0.
5-4	Biomed	Information corrected.
5-5	Edit configuration	Minor changes in Alarm sound level, Alarm limits and NIV alarms. Startup configuration information added.
5-5	Change access code	Change access code information added.
5-6	Software installation	Software information changed. Software delivery information changed.
5-6	Field Service System	Information corrected.
6-2	General	System version reference changed.
6-3	Pre-use check	Patient circuit test information added.
6-8	Safety valve test	PC 1772 replacement information corrected.
6-9	Flow transducer test	Information about water in the cassette corrected.
6-9	Battery switch test	Information that the test will not be performed if less than 10 minutes backup time remains added.
6-10	Separate Patient circuit test	Patient circuit test information added.
6-11	Error code 2 and 3	Recommended actions corrected.
6-14	Error code 48, 49 and 50	Information added.
6-15	Error code 20005	Information added.
6-16	Restart ventilator	Information added.
7-2	General	Battery module life span information changed.
7-6	Battery modules	Battery module maintenance information changed.
7-6	Completing the Preventive maintenance	Preventive maintenance time meter and log book information corrected.

## Revision 02

### Revision history table – Revision 02

In the table below, the following keywords are used in 'Comment' column:

- **Added.** Information added to the manual e.g. due to new functionality.
- **Changed.** Information changed in the manual e.g. due to changed functionality.
- **Corrected.** Corrections made due to printing errors or lack of information in the previous version of the manual.

### General changes – Revision 02

- O<sub>2</sub> Sensor is added as an alternative to the O<sub>2</sub> cell in several texts throughout the manual.

These changes are not included in the Revision history table below.

Page	Section	Comment
1-4	Symbols used in this manual	Symbols changed.
1-5	Service	System SW recommendation added.
1-5	Hazard notices	Cleaning information corrected.
1-6	Environmental declaration	Backlight Inverter corrected. O <sub>2</sub> cell corrected. O <sub>2</sub> Sensor added.
1-7	Environmental declaration	Product End-of-Life information added.
2-3	Descriptions of optional equipment	Support Arm 176 added. Humifier Holder for rail added. Loudspeaker booster kit added. Isolation shield with drip guard added.
2-4	User Interface	On/Off switch and switch cover information in text and illustration added.
2-7	Patient Unit	O <sub>2</sub> Sensor information in text and illustration added.
2-9	Monitoring	O <sub>2</sub> Sensor information added.
3-2	Memory types used in SERVO-s	O <sub>2</sub> Sensor information added.
3-2	PC 1777 Panel	On/Off switch and switch cover information added.
3-2	Loudspeaker	Loudspeaker booster kit information moved to section 'Optional equipment'.
3-4	Inspiratory pipe	O <sub>2</sub> Sensor information added.
3-5	O <sub>2</sub> Sensor	O <sub>2</sub> Sensor functional description added.
3-10	PC 1862 DC/DC & Standard connectors	P63 Alarm output connector information moved to section 'Optional equipment'.
3-12	Optional equipment	Alarm output connector information extended and moved from section 'PC 1862 DC/DC & Standard connectors'. Loudspeaker booster kit information extended and moved from section 'Loudspeaker'. Isolation shield with drip guard added



4-3	User Interface	On/Off switch cover information added. Threadlocking adhesive information corrected. Text regarding PC Card eject button corrected. On/Off switch position during assembling information added.
4-4	PC 1777 Panel	On/Off switch and switch cover information added.
4-8	TFT Display Type 2	New TFT Display cable and cable locking device on Type 2, information added.
4-12 4-13	Membrane foil	New spare part, assembling information added.
5-4	Using the Menu and Biomed key	Minor changes due to System version 3.1.
5-4	Biomed	Report PM functionality changed.
5-5	Startup configuration	Corrected, System Version 3 required.
5-5	O <sub>2</sub> cell adaption	Corrected.
6-2	General	System version reference changed.
6-8	O <sub>2</sub> cell/sensor test	O <sub>2</sub> Sensor and gas mixture information added.
6-12	Error code 12	Recommended actions corrected.
7-2	General	Text regarding regular cleaning and extended cleaning corrected (adapted to the User's Manual).
7-2	Preparations	Text regarding check of 'Technical alarms' added.
7-4	Bacteria filter for O <sub>2</sub> cell	O <sub>2</sub> Sensor information added.
9-1 9-5	Service Manual revision history	New chapter added.
10-1	Diagrams	Chapter number changed from 9 to 10.
10-3	Functional Main Blocks diagram	O <sub>2</sub> Sensor information added. Battery module information corrected. PC 1786 Exp. channel cassette corrected, temperature sensor shown in the diagram.



Only personnel trained and authorized by MAQUET shall be permitted to perform installation, service or maintenance of the SERVO-s.



Make sure to prepare the SERVO-s properly before disassembling and assembling. Refer to section 'Hazard notices' in chapter 'Important'.

Any service or maintenance must be noted in a log book.

After any installation, maintenance or service intervention in the SERVO-s, perform a 'Pre-use check'. Refer to the 'SERVO-s Ventilator System – User's Manual' for details.

This product contains electronic and electrical components. Discard disposable, replaced and left-over parts in accordance with appropriate industrial and environmental standards.



## 10. Diagrams

Standard connectors ..... 10 - 2  
Functional Main Blocks diagram ..... 10 - 3

### Standard connectors

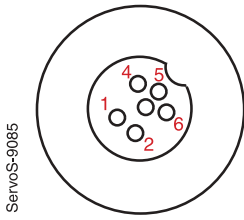

**N28 / N70 – Control cable**

1. +12V\_UNREG\_PANEL
2. GND
3. LED\_CONTROL
4. ON\_OFF\_CONTROL
5. CAN\_PANEL.H
6. CAN\_PANEL.L

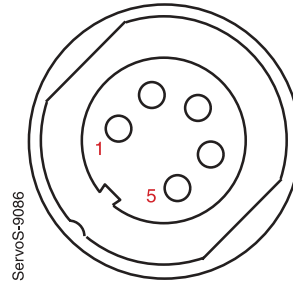

**N26 – External +12 V DC supply input**

1. +12V\_UNREG\_EXT\_DC
2. +12V\_UNREG\_EXT\_DC
3. –
4. GND
5. GND

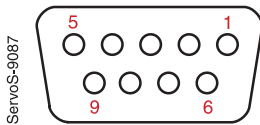

**N29 – RS232**

1. –
2. CI\_RDX\_ISO
3. CI\_TDX\_ISO
4. CI\_DTR\_ISO
5. GND\_ISO
6. –
7. –
8. –
9. –

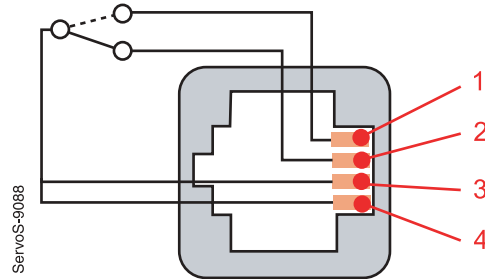

**P63 – Alarm output connector**

1. NO – Normally Open
2. NC – Normally Closed
3. Common
4. Common

# Functional Main Blocks diagram

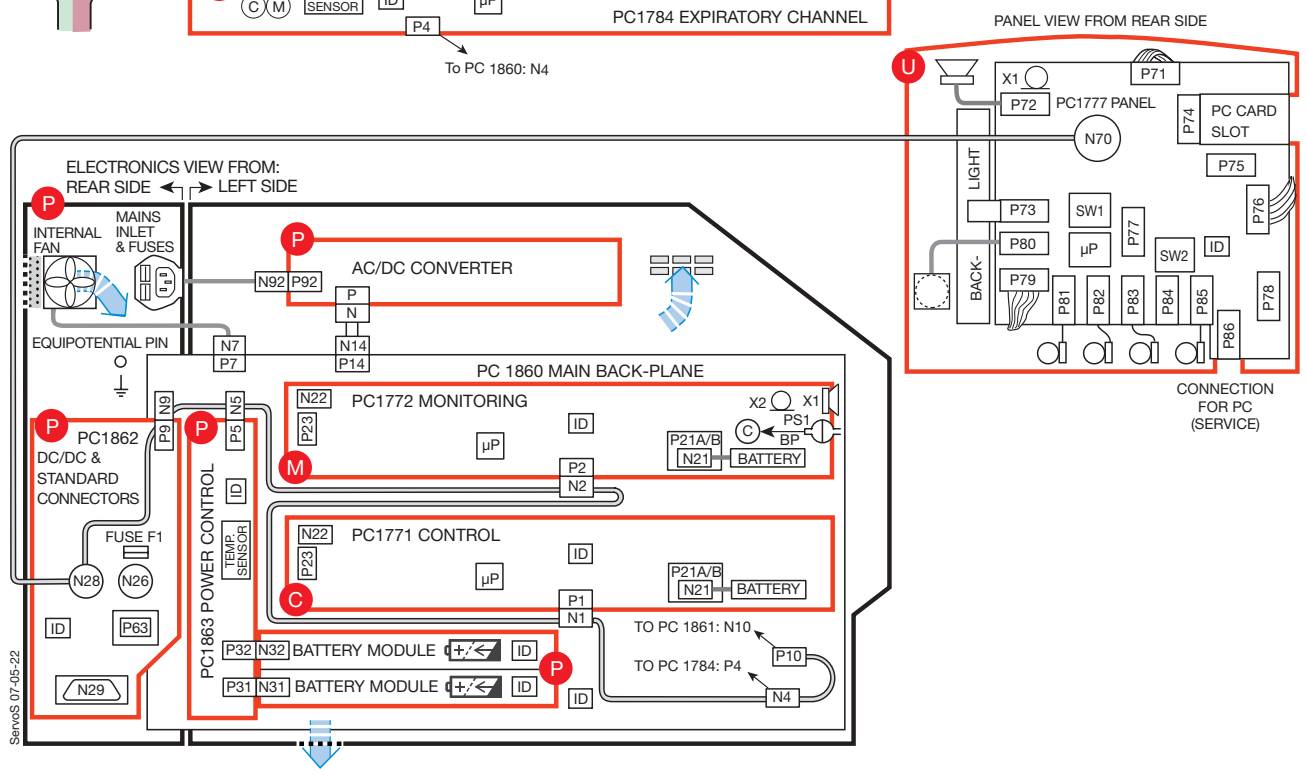
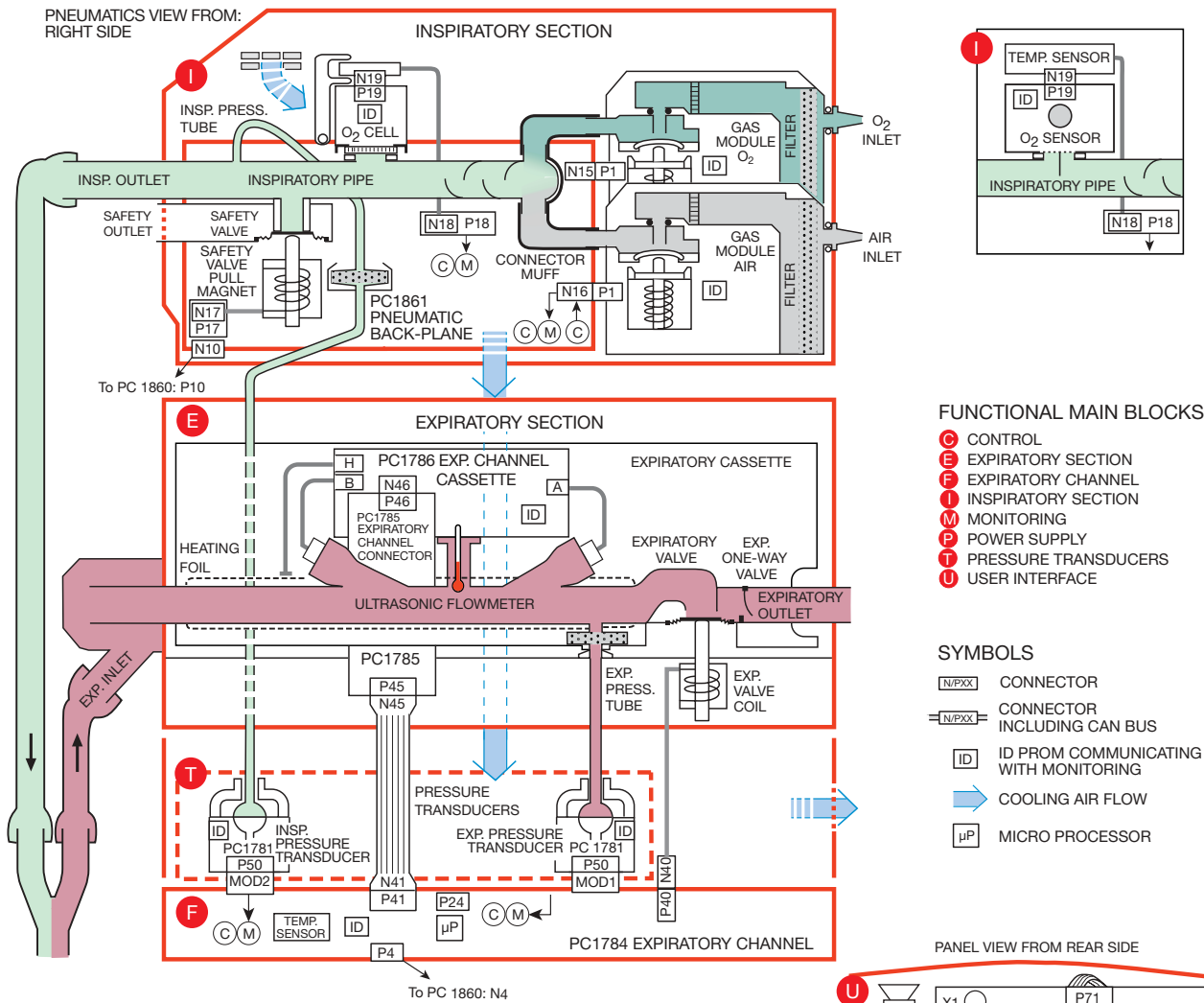

# MAQUET

Maquet Critical Care AB  
SE-171 95 Solna, Sweden  
Phone: +46 8 730 73 00  
[www.maquet.com/criticalcare](http://www.maquet.com/criticalcare)

**For local contact:**  
Please visit our website  
[www.maquet.com](http://www.maquet.com)

## GETINGE

GETINGE GROUP is a leading global provider of equipment and systems that contribute to quality enhancement and cost efficiency within healthcare and life sciences. Equipment, services and technologies are supplied under the brands ARJO for patient hygiene, patient handling and wound care. GETINGE for infection control and prevention within healthcare and life science and MAQUET for Surgical Workplaces, Cardiopulmonary and Critical Care.