

# 8. P.C.B Diagrams

## 8-1 P.C.B Diagrams

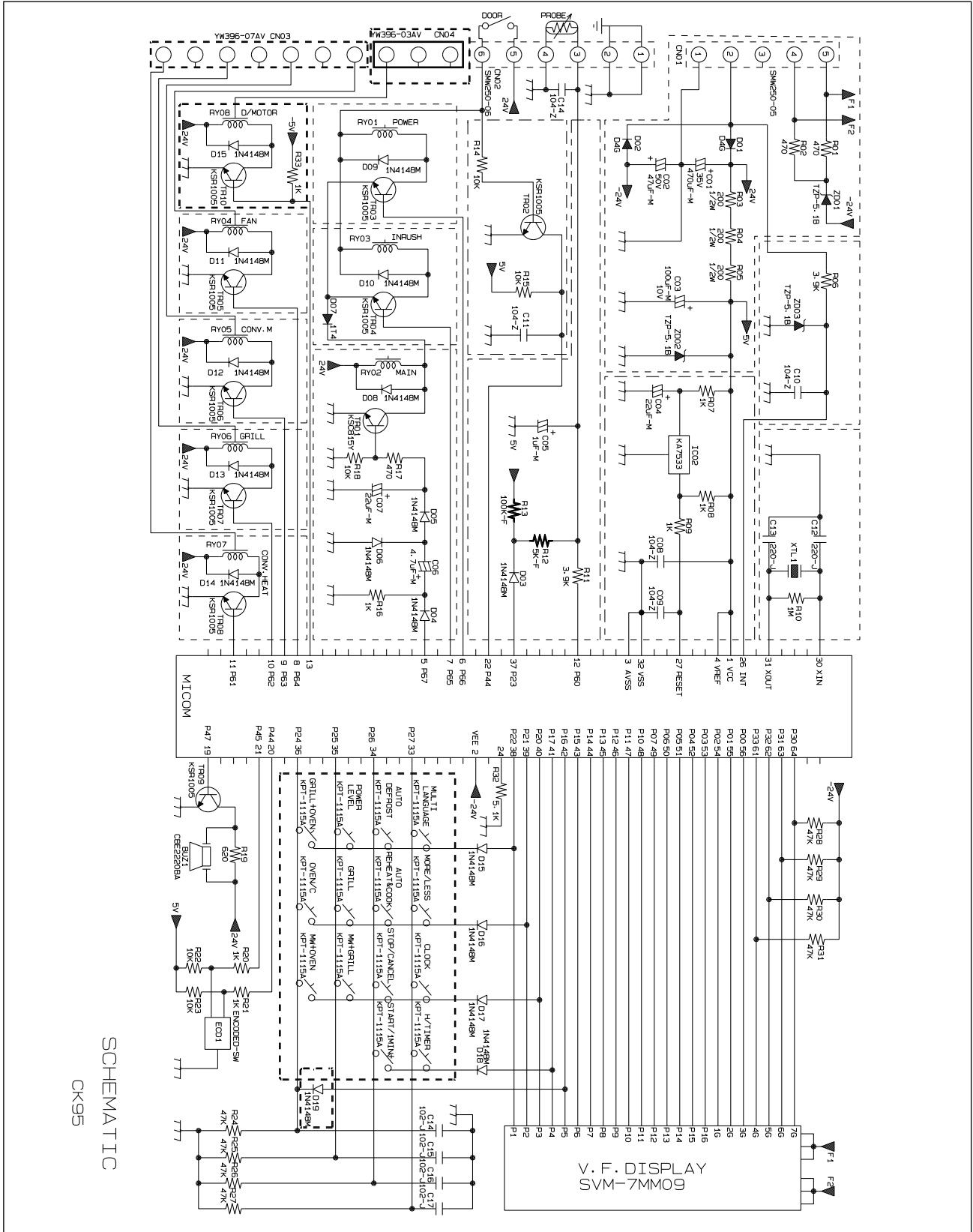

# 9. Schematic Diagrams

## 9-1 Schematic Diagrams

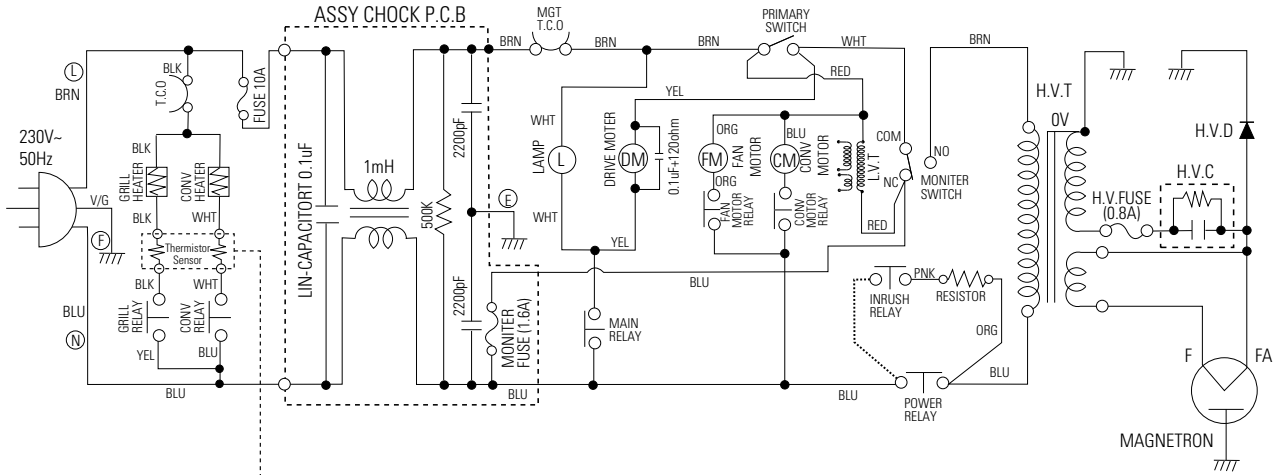

**CONDITION OF OVEN**

DOOR IS OPENED  
COOK OFF

**WIRING COLOR**

- BRN : BROWN
- WHT : WHITE
- RED : RED
- Y/G : YELLOW/GREEN
- BLU : BLUE
- ORG : ORANGE
- YEL : YELLOW
- PNK : PINK

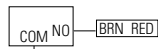
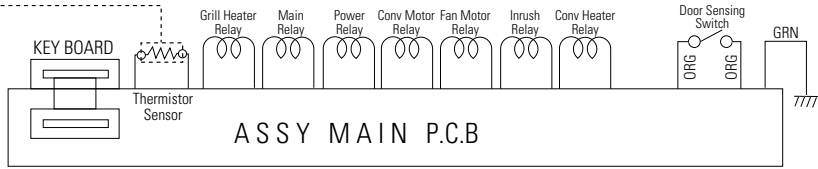

PRIMARY LATCH SWITCH

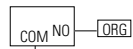

DOOR SENSING SWITCH

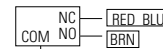

MONITOR SWITCH

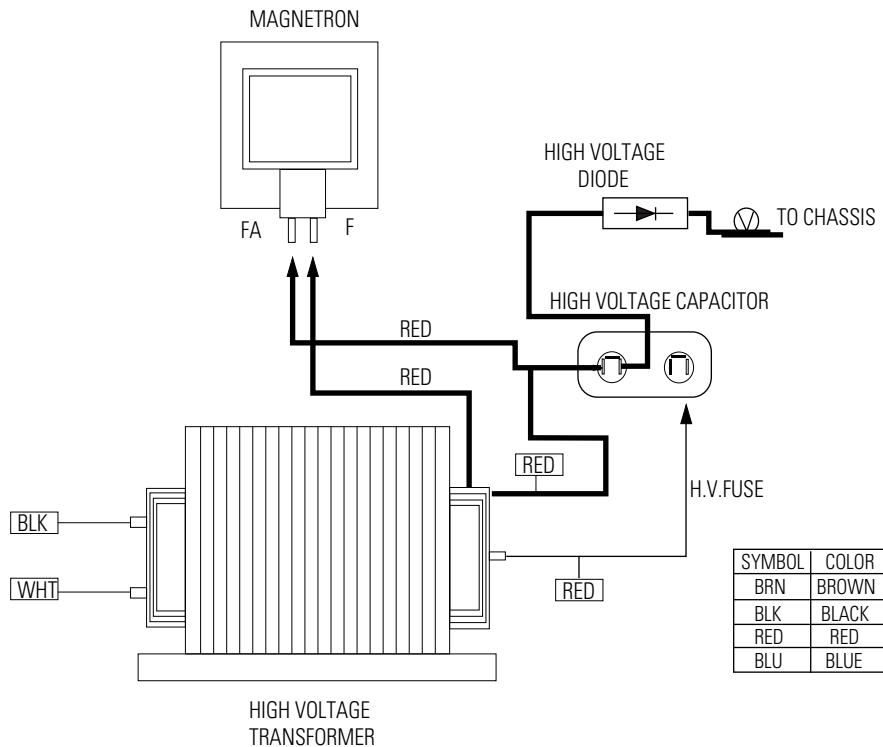

SYMBOL	COLOR
BRN	BROWN
BLK	BLACK
RED	RED
BLU	BLUE