

# Thermal Resistance Theory and Practice

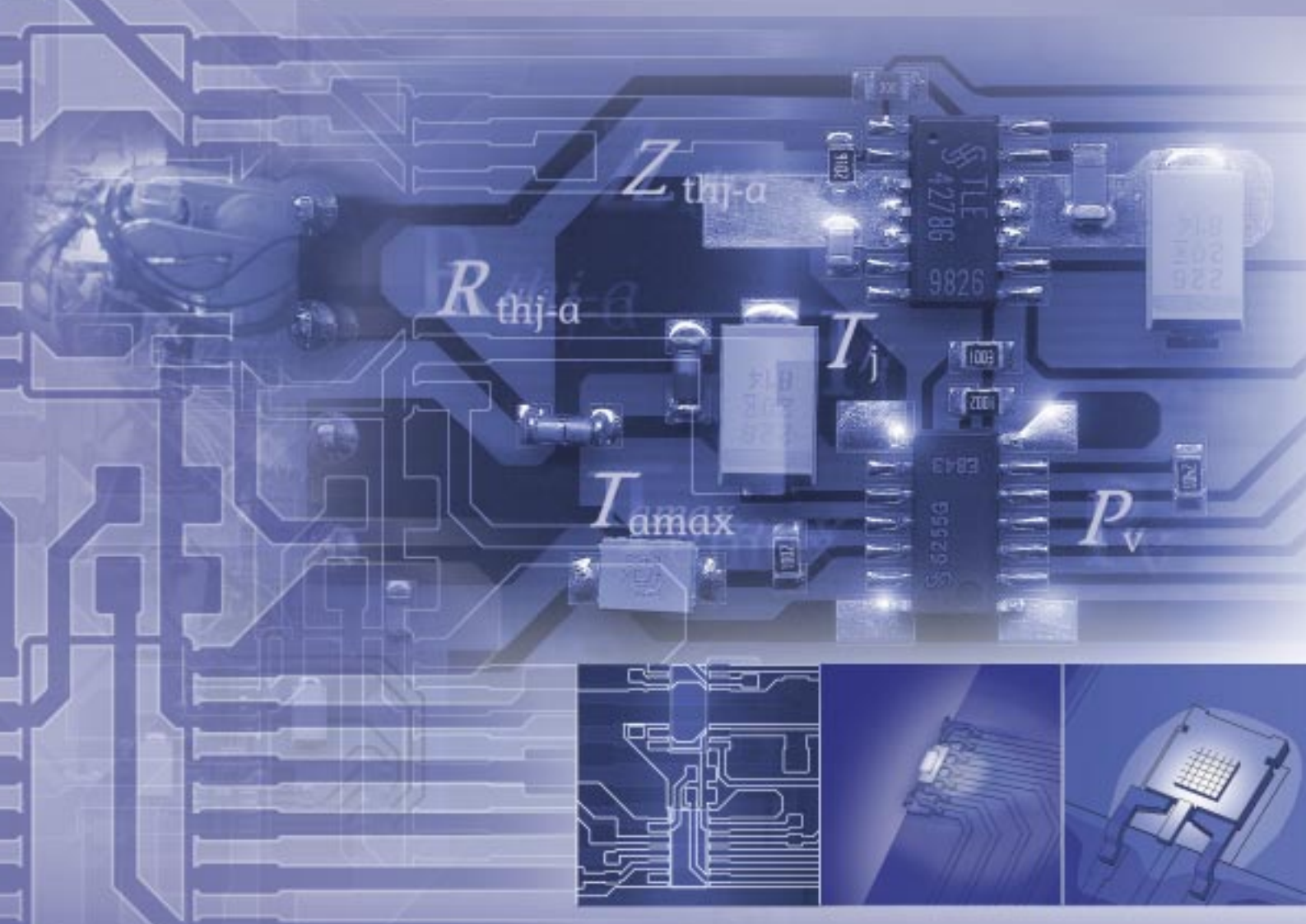

<http://www.infineon.com>

## SMD Packages



Never stop thinking

**Edition January 2000**

**Published by  
Infineon Technologies AG,  
St.-Martin-Strasse 53,  
D-81541 München  
© Infineon Technologies AG 1999  
All Rights Reserved.**

**Attention please!**

The information herein is given to describe certain components and shall not be considered as warranted characteristics.

Terms of delivery and rights to technical change reserved.

We hereby disclaim any and all warranties, including but not limited to warranties of non-infringement, regarding circuits, descriptions and charts stated herein.

Infineon Technologies is an approved CECC manufacturer.

**Information**

For further information on technology, delivery terms and conditions and prices please contact your nearest Infineon Technologies Office in Germany or our Infineon Technologies Representatives worldwide (see address list).

**Warnings**

Due to technical requirements components may contain dangerous substances. For information on the types in question please contact your nearest Infineon Technologies Office.

Infineon Technologies Components may only be used in life-support devices or systems with the express written approval of Infineon Technologies, if a failure of such components can reasonably be expected to cause the failure of that life-support device or system, or to affect the safety or effectiveness of that device or system. Life support devices or systems are intended to be implanted in the human body, or to support and/or maintain and sustain and/or protect human life. If they fail, it is reasonable to assume that the health of the user or other persons may be endangered.

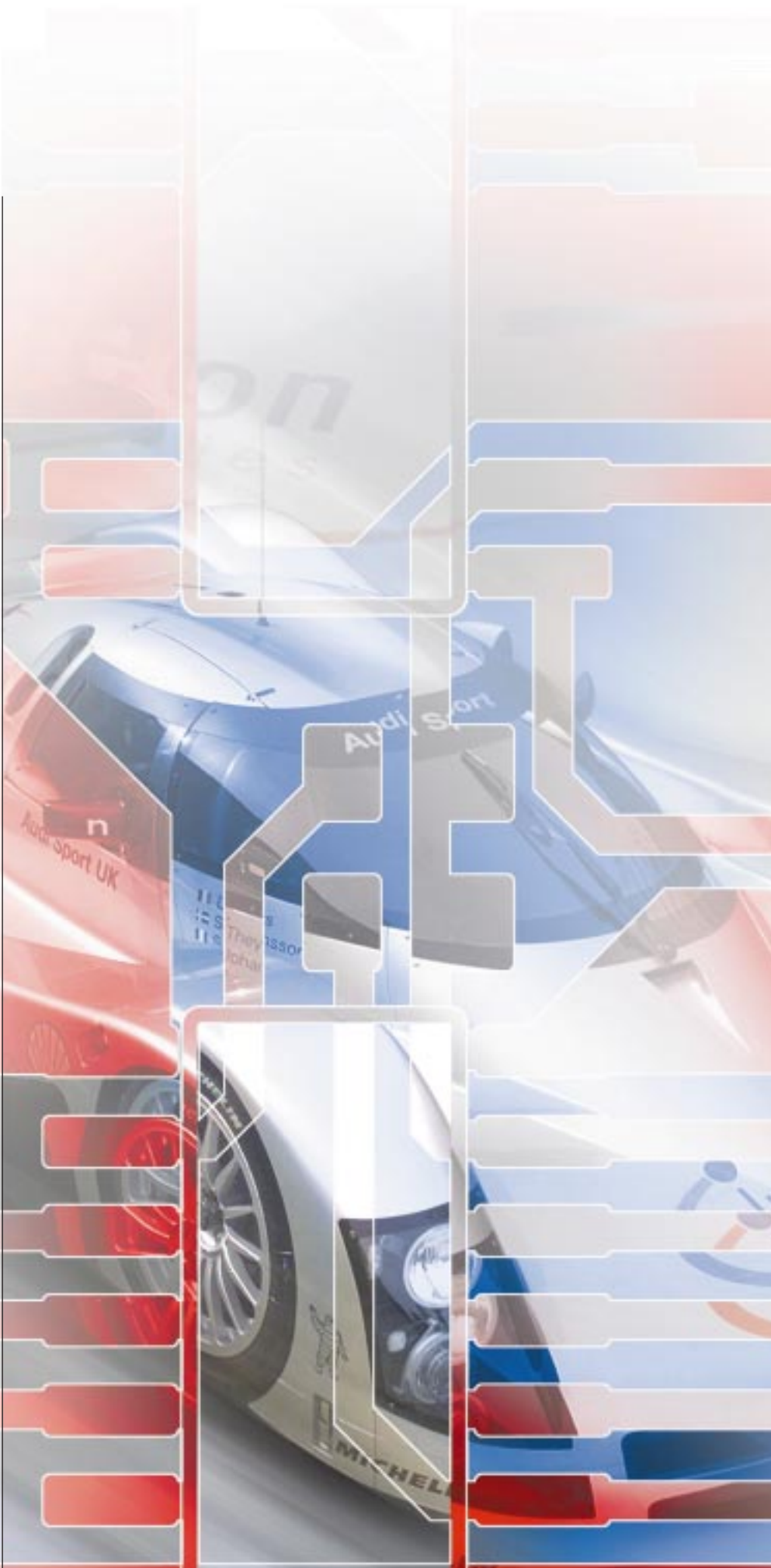

# Thermal Resistance - Theory and Practice

# Contents

Introduction .....	4
SMD-Package Properties for Power Applications .....	5
Using a Printed Circuit Board as a Heat Sink .....	6
Static Properties .....	6
Dynamic Properties .....	9
Finite Element Method (FEM) .....	13
Determining the Static Heat Resistance .....	16
Measuring the $R_{thj-a}$ in the Real Application .....	17
Determining the Dynamic Heat Resistance .....	19
Summary .....	20
Package and Thermal Information .....	21

Michael Lenz  
Günther Striedl  
Ulrich Fröhler

# Thermal Resistance - Theory and Practice

## Introduction

Power-SMD applications or  
what's the size of the heat sink ?

More and more frequently,  
modern SMD-component users  
(Surface Mounted Devices) ask  
the question, "What's the size of  
the heat sink ?"

The reason: The trend from  
through-hole packages to  
low-cost SMD-applications is  
marked by the improvement of  
chip technologies.

„Silicon instead of heat sink“ is  
therefore possible in many cases.  
The printed circuit board (PCB)  
itself becomes the heat sink. As  
many applications today use  
PCBs assembled with SMD-  
technology, the emphasis is on  
Power-ICs in SMD packages  
mounted on single-sided PCBs  
laminated on one side.

Pricing pressure demands simple  
processes and lowest-cost  
solutions. This report describes a  
solution.

## SMD-Package Properties for Power Applications

There are two basic groups of packages:

**Heat Sink** packages are the first group. The heat sink (chip carrier - lead frame) is soldered directly to the PCB. The thermal resistance of this packages between chip and heat sink is called  $R_{thj-c}$  (junction-case) and has low values.

**Thermal Enhanced Leadframes** constitute the second group of

packages. Metal bridges are connected between the chip carrier (lead frame) and the pins. From the outside, this package looks identical to standard components because the plastic molding compound conceals these details. **Figure 1** shows both types of packages with the examples P-TO252-3-1 (D-Pack) and P-DSO-14-4 (3 center pins each per side of the cooling path). The internal structure is described in more detail in this report and can be seen in **Figure 11**.

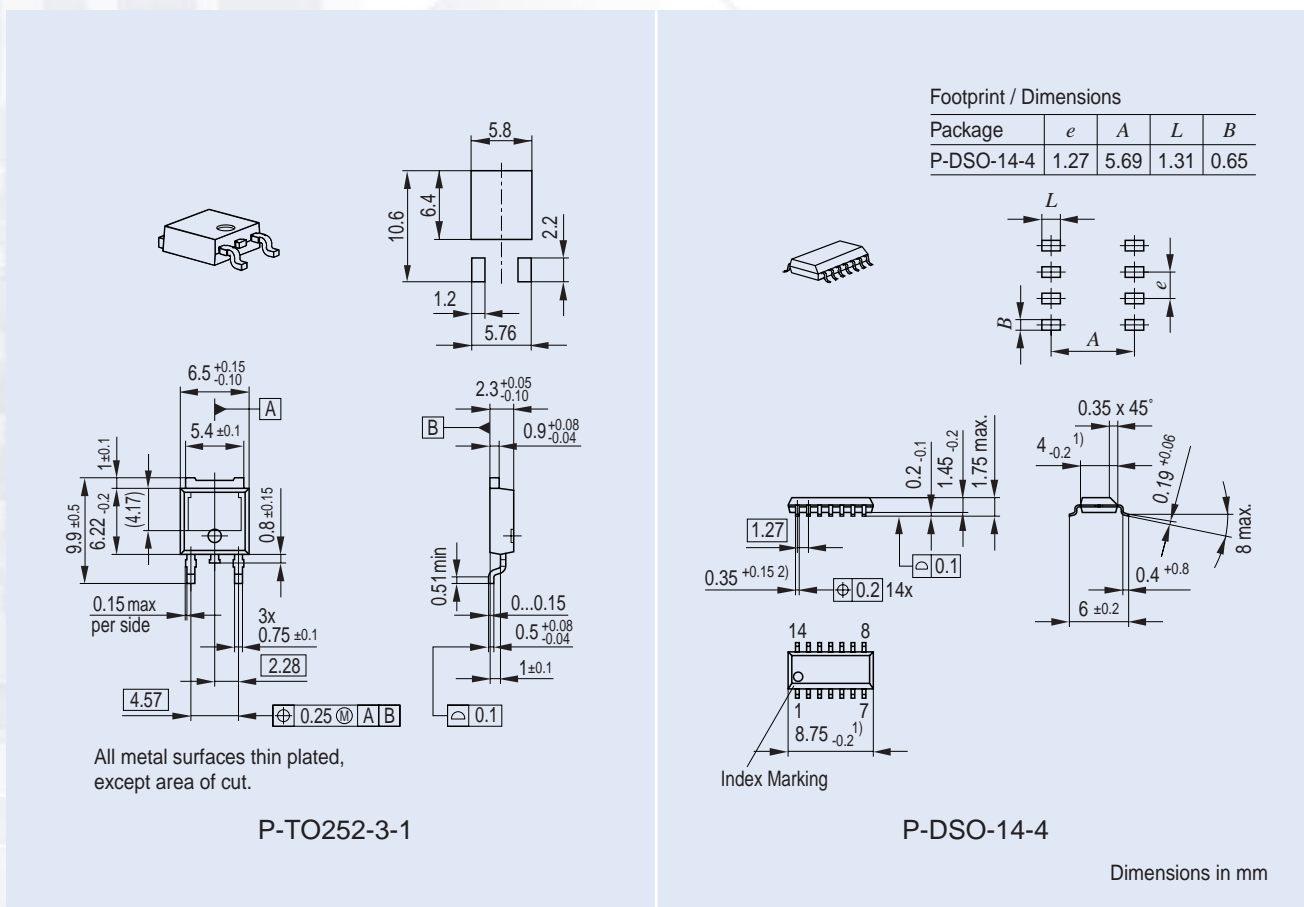

**Figure 1** Heat Sink - vs. Thermal Enhanced Package Types

# Thermal Resistance - Theory and Practice

Using a printed circuit board as a heat sink ?

How do I calculate that ?

How big does my heat sink need to be ?

Which size do we need ?

In earlier fabrications, a solid heat sink was either screwed or clamped to the power package. It was easy to calculate the thermal resistance from the geometry of the heat sink.

In SMD-technology, this calculation is much more difficult because the heat path must be evaluated: chip (junction) - lead frame - case or pin - footprint - PCB materials (basic material, thickness of the laminate) - PCB volume - surroundings.

As the layout of the PCB is a main contributor to the result, a new technique must be applied. The Appendix provides thermal data for all packages listed in **Table 1**.

**Let us start with some theoretical considerations:**

## Static Properties

To facilitate discussion of the static properties of a Power IC (PIC), the internal structure of a PIC and its method of mounting on a PCB or heat sink is illustrated in **Figure 2**. The PIC consists of a chip mounted on a chip carrier or lead frame, and held by solder or bonding adhesive. The lead frame consists of a high-conductivity material such as copper, and can have a

Package	Heat Sink / Pin
P-DSO-8-1	–
P-DSO-14-4	Pin 3-5; 10-12
P-DSO-16-1	–
P-DSO-20-1	–
P-DSO-20-6	Pin 4-7; 14-17
P-DSO-24-3	Pin 5-8; 17-20
P-DSO-28-6	Pin 6-9; 20-23
P-DSO-20-10	Tab
P-DSO-36-10	Tab
SCT-595-5-1	Pin 2; 5
SOT-223-4-2	Tab or Pin 4
P-TO252-3-1 (D-Pack)	Tab
P-TO263-5-1	Tab

**Table 1** The Most Important SMD-Packages

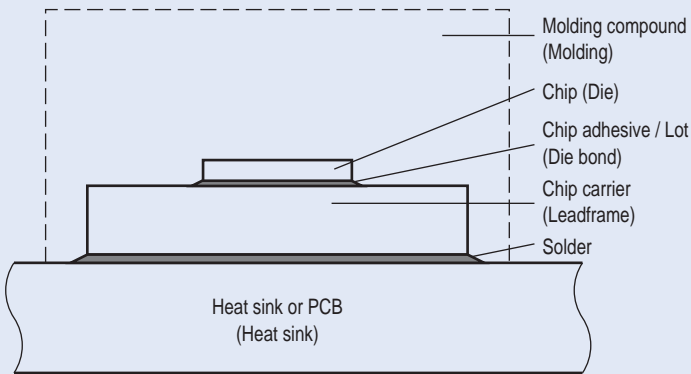

**Figure 2** Internal Structure of a PIC and Method of Mounting on a Heat Sink

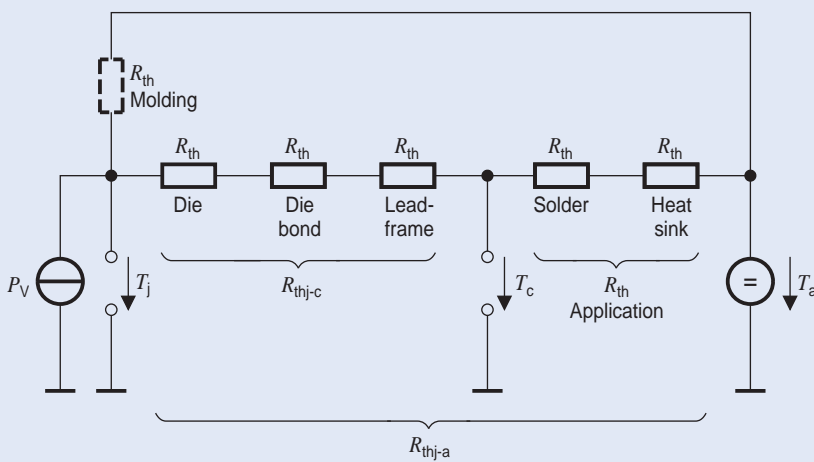

**Figure 3** Static Equivalent Circuit for the Structure shown in Figure 2

thickness of several millimeters. The associated static equivalent circuit is shown in **Figure 3**. The following analogies with electrical quantities have been used:

- The power dissipation  $P_V$  occurring close to the chip surface is symbolized by a current source.
- The thermal resistances are represented by ohmic resistors. The "resistance" network is essentially a serial connection to the ambient temperature. As a first approximation, the parallel-connected thermal resistance of the molding (broken lines) can be neglected in power packages.
- The ambient temperature is represented by a voltage source.

In accordance with the analogy, the thermal current  $P_V = Q/t$  can now be calculated from the "thermic Ohm's law"

$$V = I \cdot R \text{ as } T_j - T_a = P_V \cdot R_{thj-a}$$

For the purpose of discussing the application as a whole, the function  $P_V = f(T_a)$  is of practical interest. One obtains:

$$P_V = -T_a / R_{thj-a} + T_j / R_{thj-a}$$

This is a descending straight line of gradient  $-1 / R_{thj-a}$  with its zero at  $T_j$ .

# Thermal Resistance - Theory and Practice

In **Figure 4**, this function is shown for the P-DSO-14-4 Package (Thermal Enhanced Power Package) mounted on the standard application board. From this function, the user can derive the permissible power dissipation directly for any ambient temperature. At  $T_a = 85\text{ }^\circ\text{C}$ , for example, the permissible dissipation is approximately 0.7 W. The exact value can be calculated from the equation  $P_V = (T_j - T_{amax}) / R_{thj-a} = 65\text{ K} / 92\text{ K/W} = 0.7\text{ W}$ . It should be noted that in the data sheets of the PICs the power dissipation is given as a function of the package (case) temperature  $T_C$ , because the application-specific thermal resistances are not known to the manufacturer. This function, like the previous one, is a descending straight line. The slope now has the value  $1 / R_{thj-c}$ . The zero remains at  $T_j$ . As an example, this function is presented in **Figure 5** for the P-TO252-3-1 Package. The new P-TO252-3-1 package has a thermal resistance of max. 4 K/W and is unique in the small size of its base area when compared with packages of equivalent performance (PCB board area). At approximately  $30\text{ }^\circ\text{C}$ , the permissible power dissipation is 30 W. Higher power dissipation is prevented by intervention of the chip-internal current limiters. For this reason, the value for power dissipation at lower temperatures remains constant.

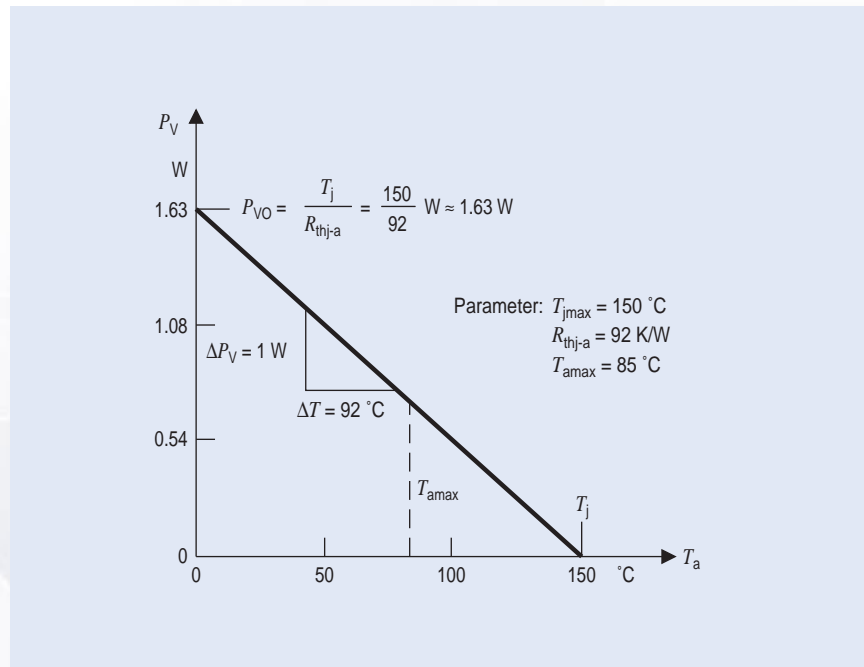

**Figure 4** Permissible Power Dissipation of the P-DSO-14-4 Package Mounted on a PCB with  $300\text{ mm}^2$  Cooling Area, as a Function of Ambient Temperature

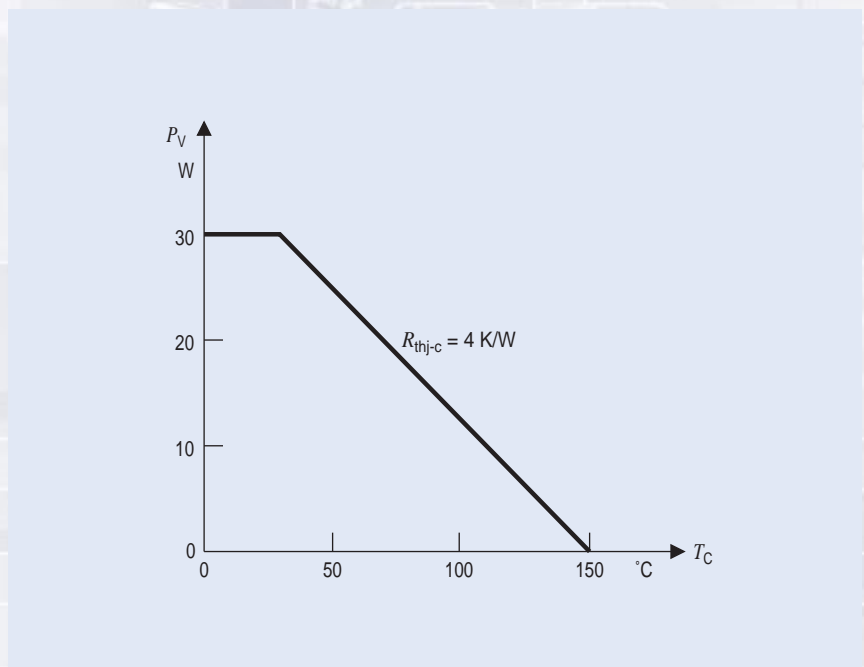

**Figure 5** Permissible Power Dissipation of the P-TO252-3-1 as a Function of the Package (Case) Temperature



## Dynamic Properties

As mentioned earlier, the thermal behavior of PICs changes when dynamic phenomena are considered (pulse power operation). This behavior can be described in terms of thermal capacity  $C_{th}$ , which is directly proportional to the relevant volume  $V$  (in  $\text{cm}^3$ ), to the density  $\rho$  (in  $\text{g}/\text{cm}^3$ ) of the material and to a proportionality factor of the specific heat  $c$  in  $\text{Ws}/\text{g} \cdot \text{K}$ .

The applicable equation is:

$$C_{th} = c \cdot \rho \cdot V = m \cdot c$$

This means: The thermal capacity of a body of mass  $m = \rho \cdot V$  corresponds to the quantity of heat

needed to heat the body by  $1^\circ\text{C}$ . To calculate the temperature change  $\Delta T$  it is necessary to use the quantity-of-charge equation for a capacitance  $C$ .

The equation is:

$$V \cdot C = I \cdot t = Q$$

By analogy, the quantity-of-heat equation is:

$$\Delta T \cdot C_{th} = P \cdot t = Q$$

This means: Just as the current  $I = Q/t$  represents a transport of charge per unit of time, the power dissipation  $P$  represents the transport of thermal energy per unit of time. Consequently:

$$\Delta T = \frac{P \cdot t}{C_{th}}$$

The equivalent circuit of the P-TO263-7-3 power package, with the thermal capacities added, is shown in **Figure 6**. The thermal capacities calculated from the material and the volume are shown in parallel with the thermal resistances.

When calculating the components of a network it is necessary to know the thickness  $d$ , the cross-sectional area  $A$  and the thermal conductivity  $L$  in  $\text{W}/\text{m} \cdot \text{K}$ , in order to obtain the appropriate thermal resistance  $R_{th}$ . The formula is:

$$R_{th} = \frac{d}{L \cdot A} \left[ \frac{\text{K}}{\text{W}} \right]$$

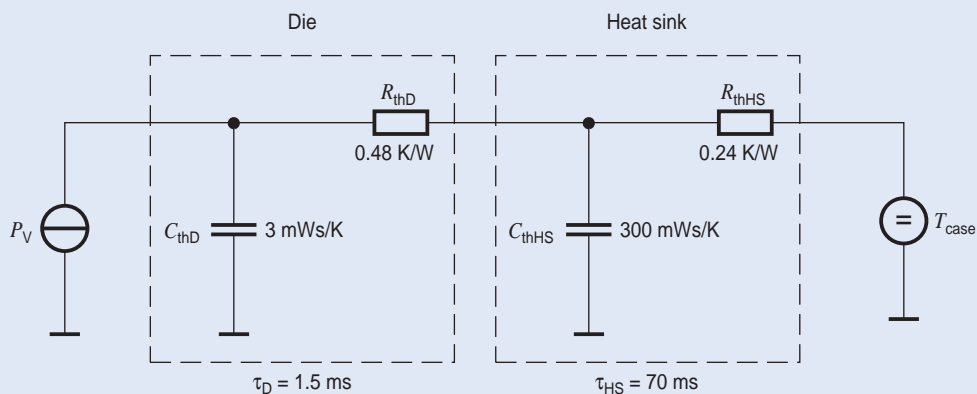

**Figure 6** Thermal Equivalent Circuit of the P-TO263-7-3 Package (Simplified)

# Thermal Resistance - Theory and Practice

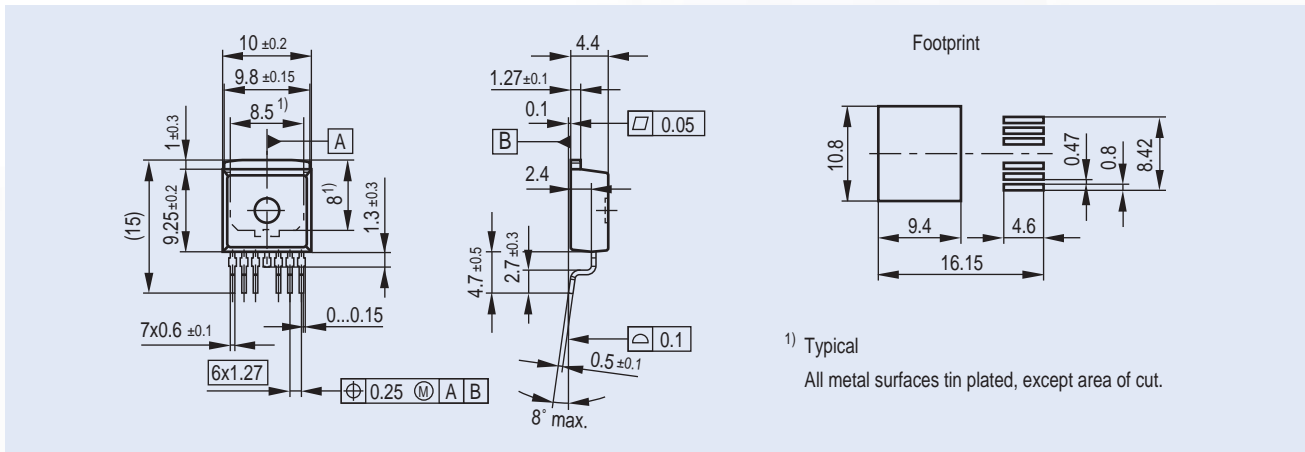

**Figure 7** Outline Drawing of the P-TO263-7-3 Power Package

To calculate the thermal capacity  $C_{th}$ , it is necessary to know the volume  $V = d \cdot A$ , the specific weight  $\rho$  in g/cm<sup>3</sup> and the specific thermal capacity  $c$  in Ws/g · K.

The thermal capacity  $C_{th}$  is calculated from:  
 $C_{th} = m \cdot c$  (Ws/T).  
 The package dimensions are shown in **Figure 7**.

**Table 2** lists all the important parametric data of the P-TO263-7-3 package.

Parameters for the Chip	Symbol	Value	Dimension
Area	$A_D$	5	mm <sup>2</sup>
Thickness	$d_D$	360	μm
Thermal conductivity of silicon	$L_{Si}$	150	W/m · K
Thermal resistance of chip	$R_{thD}$	0.48	K/W
Specific weight of silicon	$\rho_{Si}$	2.33	g/cm <sup>3</sup>
Mass of chip	$m_D$	4.2	mg
Spec, thermal capacity of Si	$c_{Si}$	approx. 0.7	Ws/g · K
Thermal capacity of chip	$C_{thD}$	approx. 3	mWs/K
Thermal time constant of chip	$\tau_D$	approx. 1.5	ms
Parameters for the Heat Slug	Symbol	Value	Dimension
Area (effective area of 64 mm <sup>2</sup> )	$A_{HS}$	14	mm <sup>2</sup>
Thickness	$d_{HS}$	1.27	mm
Thermal conductivity of cooper	$L_{Cu}$	384	W/m · K
Thermal resistance of heat slug	$R_{thHS}$	0.24	K/W
Specific weight of cooper	$\rho_{Cu}$	8.93	g/cm <sup>3</sup>
Mass of heat slug	$m_{HS}$	0.8	g
Spec, thermal capacity of Cu	$c_{Cu}$	0.385	Ws/g · K
Thermal capacity of heat slug	$C_{thHS}$	310	mWs/K
Thermal time constant of heat slug	$\tau_{HS}$	70	ms

**Table 2** Parametric Data of the P-TO263-7-3

The die bond and molding components have been omitted from this discussion because they do not significantly influence the calculation of  $R_{thj-c}$ .

For reference, these data are listed here:

- $R_{thDB} = 0.01$  to  $0.1$  K/W;
- $C_{thDB} = 0.1$  to  $0.5$  mWs/K;
- $\tau_{DB} = 1$  to  $50$  ms;
- $R_{thM} = 100$  K/W;
- $C_{thM} = 0.64$  Ws/K and
- $\tau_M = 64$  s.

(Die Bond = index: DB;  
molding = index: M)

The time constant of the die bond is smaller than that of the chip by two orders of magnitude and can, thus, be neglected.

The thermal resistance  $R_{thM}$  of the molding is even three orders of magnitude bigger than that of the chip and that of the heat slug, and, being in parallel, can be neglected also.

Pulse operation and the associated chip temperature responses also deserve examination.

In accordance with the analogy to electrical systems, the chip temperature response can be viewed like a voltage increase across an

RC section which is being fed by a current pulse generator.

The following relationship applies:

$$V_{(t)} = R \cdot I \cdot (1 - e^{t/R \cdot C})$$

and for the increase in temperature:

$$T_{(t)} = R_{th} \cdot P \cdot (1 - e^{t/R_{th} \cdot C_{th}})$$

This heating-up and cooling-down process is presented qualitatively in **Figure 8** (valid for  $t_p \gg 2$  ms only).

The chip temperature goes up and down between  $T_{min}$  and  $T_{max}$ . The variation depends on the magnitude of the power pulse and its duty cycle.

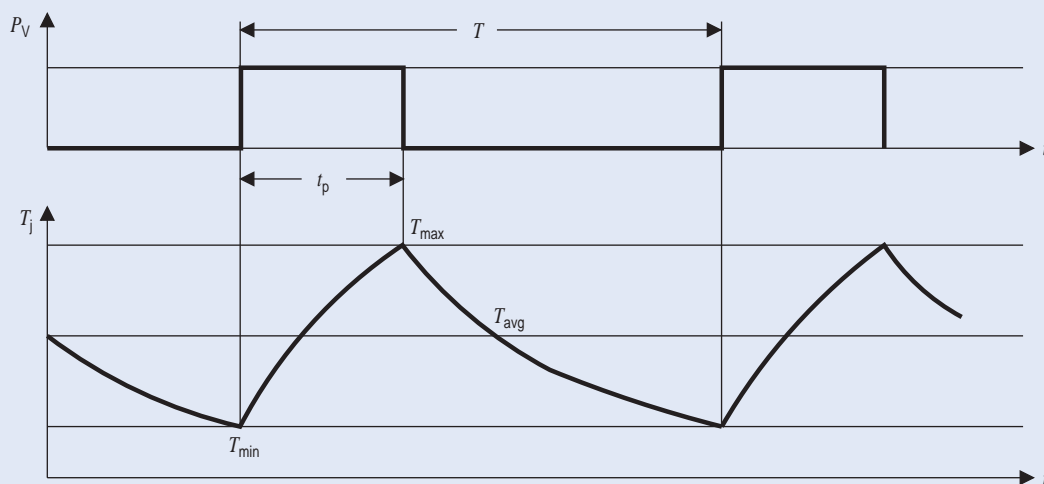
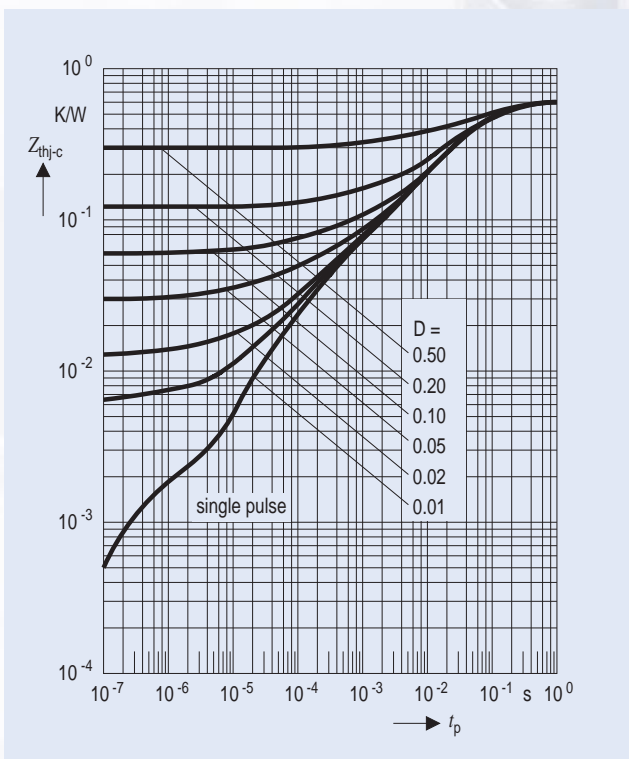

**Figure 8** Chip Temperature  $T_j$  vs. Time, for Periodic Pulse Operation

# Thermal Resistance - Theory and Practice

This junction temperature transients can be represented in the form of a function if the dynamic thermal impedance  $Z_{th} = (T_{max} - T_{min}) / P_V$  is shown versus pulse width  $t_p$  for different duty cycles (duty cycle =  $DC = t_p/T$ ) (Figure 9). A special case of this representation is the dynamic thermal impedance in single-pulse operation ( $DC = 0$ ). Figure 10 shows the thermal impedance in single-pulse operation for the

medium-power package P-DSO-14-4 for three different cooling areas on the PCB. This function clearly shows the regions of dominance of the various time constants of the chip, the lead frame, and the PCB. The chip time constant  $t_D$  lies in the millisecond range, whereas the lead frame dominates in the range of several 100 ms and the PCB in the 100-second range.



**Figure 9** Dynamic Thermal Impedance  $Z_{thj-c}$  of a P-TO263-7-3 Package

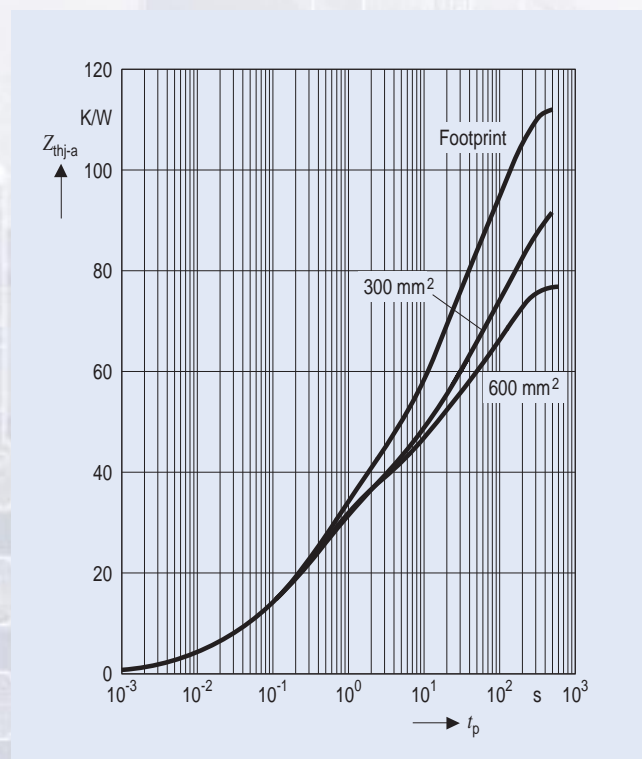
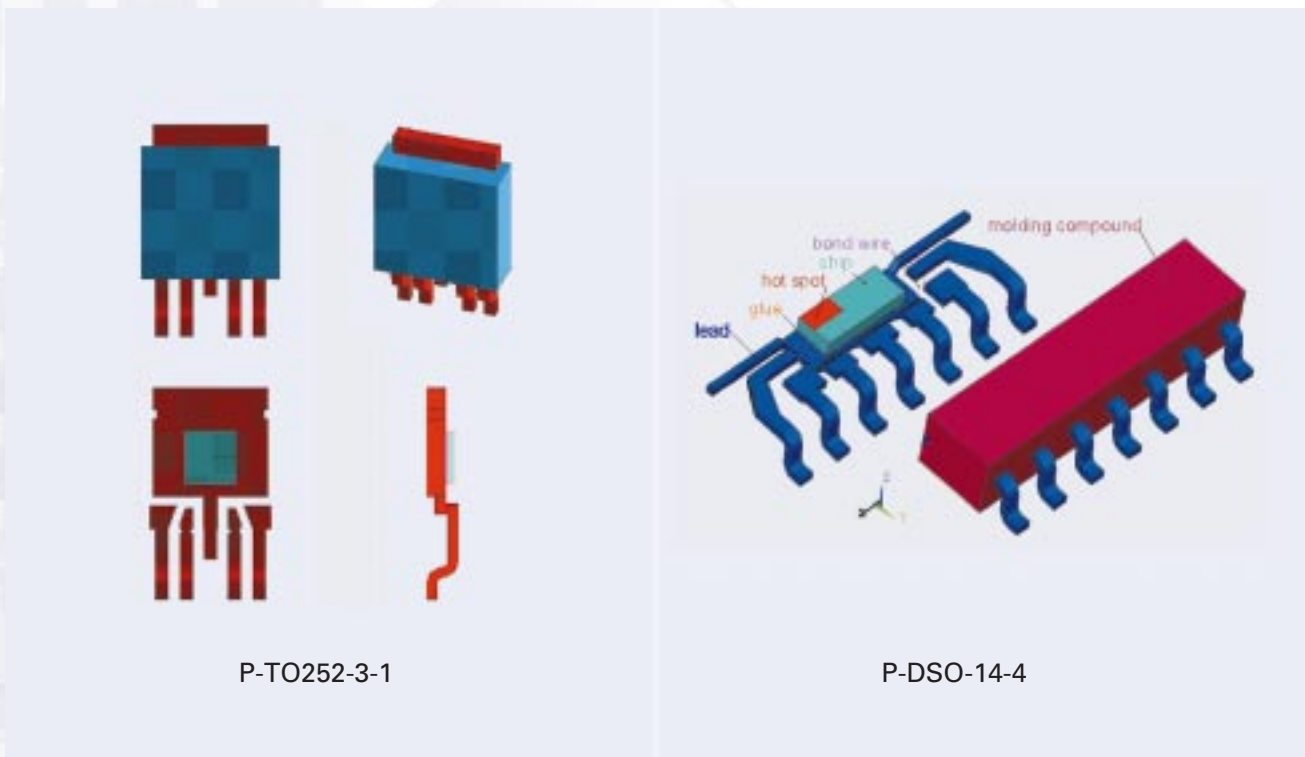

**Figure 10** Thermal Impedance of the P-DSO-14-4 Package for Single-Pulse Operation

## Finite Element Method (FEM)

The steps of the Finite Element Method (FEM) are explained below and one example is provided per group.

The geometric data of the package is entered into the FEM model to calculate the thermal resistance. This avoids time-consuming measurements. **Figure 11** shows an implemented model.



**Figure 11** FEM Model of Heat Sink and Thermal Enhanced Package

# Thermal Resistance - Theory and Practice

The temperatures of the individual components (chip, die-pad, molding compound, and leadframe) can be viewed individually or in combination (Figure 12).

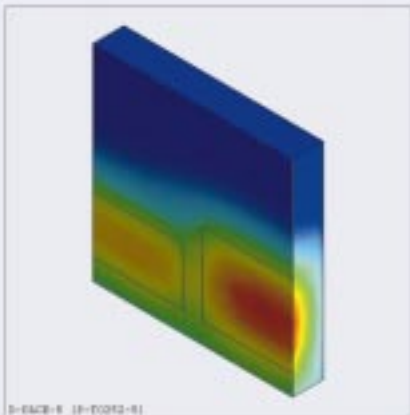

Chip with two active areas (dice only)

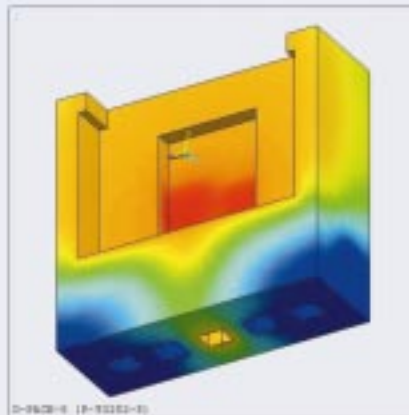

Mold compound without cooling tab, chip and lead frame



P-TO252-3-1 without mold compound with  $P_V = 3$  W for determining the  $R_{thj-c}$

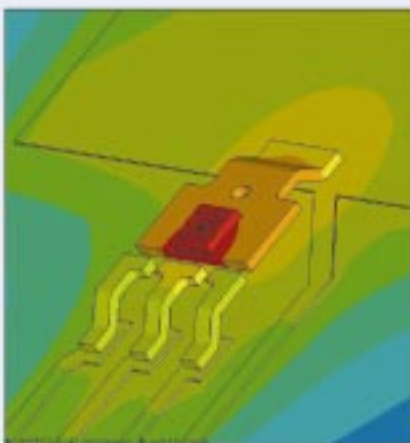

Chip and lead frame of the SOT223-4-2 package on a PCB with heat sink



Lead frame of the SCT595-5-1 on a PCB with heat sink

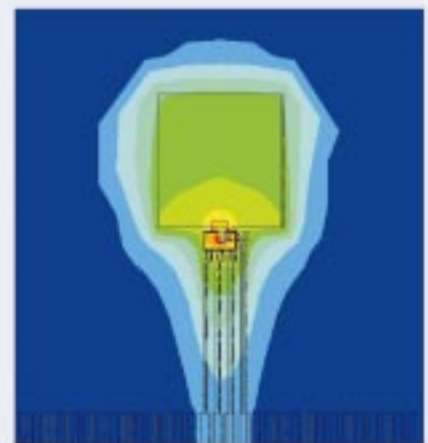

SOT223-4-2 on a PCB with 6 cm<sup>2</sup> heat sink;  $R_{thj-a} \sim 70$  K/W is calculated at  $P_V = 0.5$  W

**Figure 12 FEM Analysis Possibilities**

Three different PCBs have been created for each package model. They differ in the size of the copper laminated area A (heat sink) which is linked to the heat dissipating parts of the case (die-pad in the P-TO252-3-1 or center pins in the P-DSO-14) (**Figure 13**).

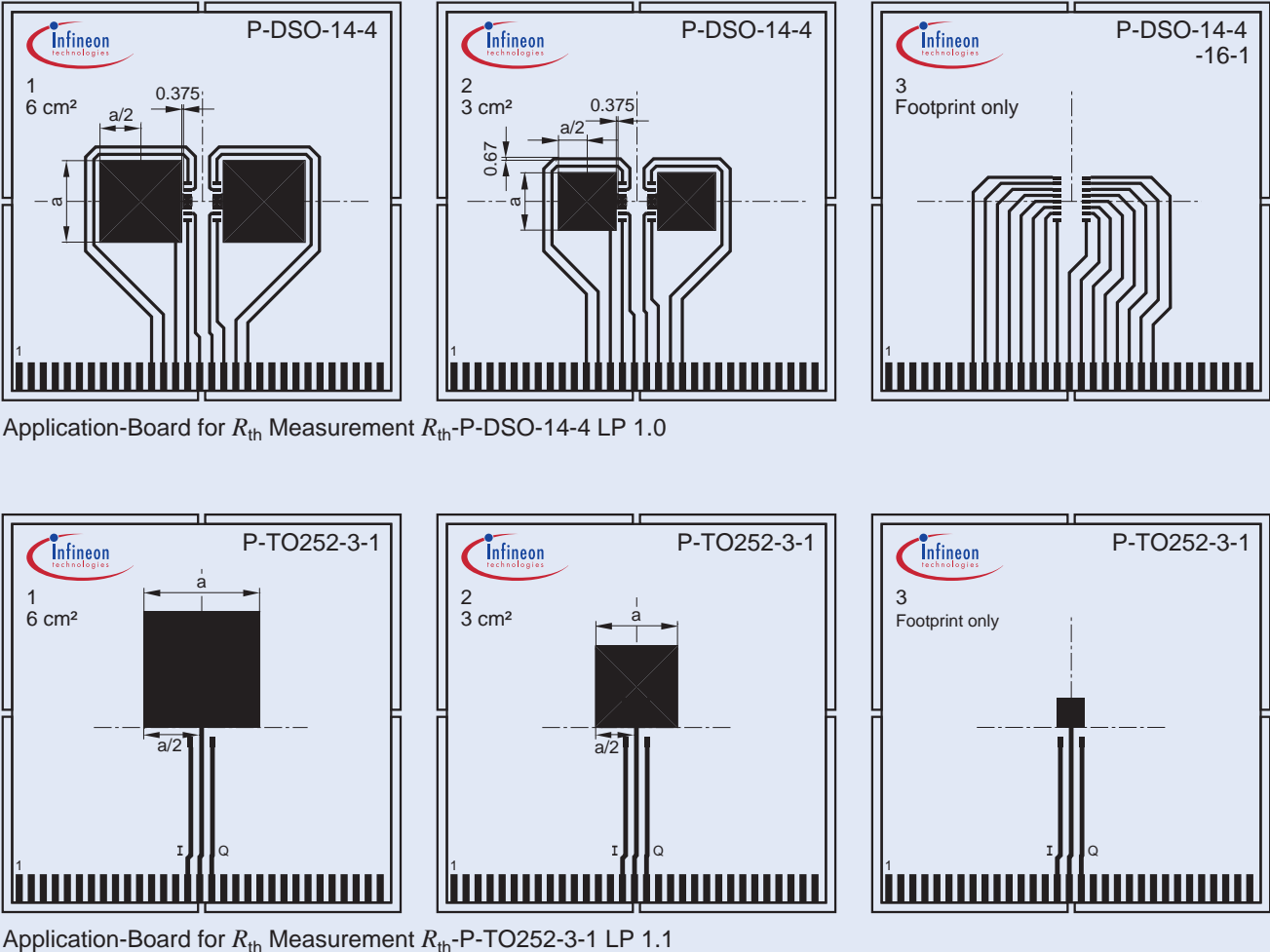

**Figure 13** PCB-Layout for FEM-Simulation P-DSO-14-4 and P-TO252-3-1

# Thermal Resistance - Theory and Practice

## Determining the Static Heat Resistance

The FEM simulation calculates the thermal static resistance  $R_{thj-a}$  (junction-ambient) and the  $R_{thj-c}$  (junction-case) for packages with enhanced die-pad or  $R_{thj-pin}$  (junction to a defined pin) for thermal enhanced P-DSO packages without die-pad. This

value depends only slightly on the active chip area. It is sufficient to simulate just one medium-sized chip (>2 mm<sup>2</sup>).

If the static thermal resistance  $R_{thj-a}$  is applied versus the PCB heat sink area, a very important function is obtained for the application of the component. By estimating the heat sink area in a real application, the user can

easily determine the expected  $R_{thj-a}$ , especially as the simulated values are calculated in still air. Therefore, they represent the "worst case". In real applications the values for the heat resistance are much lower. At an air stream of 500 lin ft/min (linear feet per minute) the  $R_{thj-a}$  of the P-DSO-14-4 for example is up to 15 % lower (**Figure 15**).

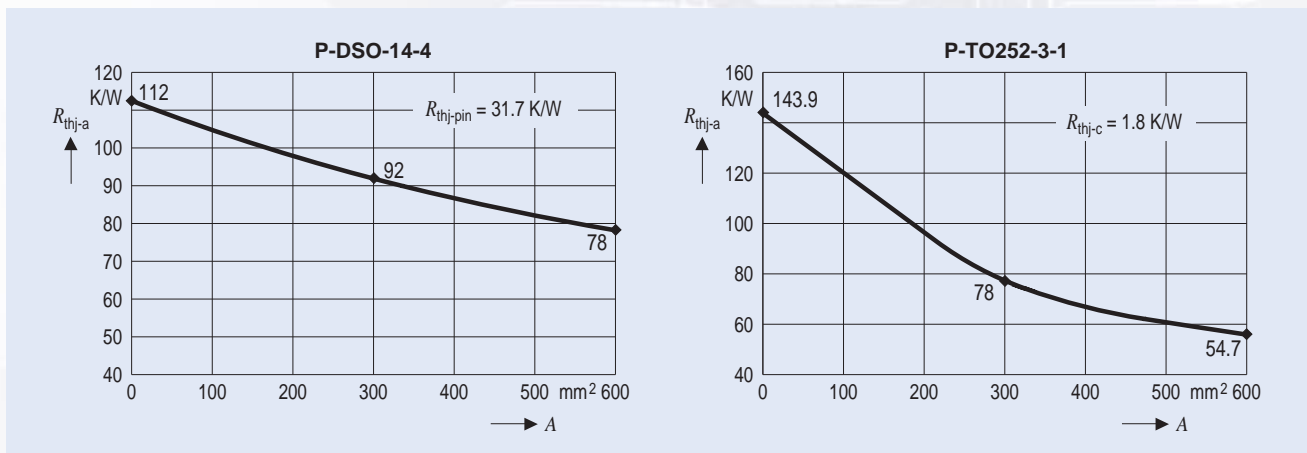

**Figure 14** Thermal Resistance Junction to Ambient  $R_{thj-a}$  vs. PCB Heat Sink Area  $A$  at zero airflow

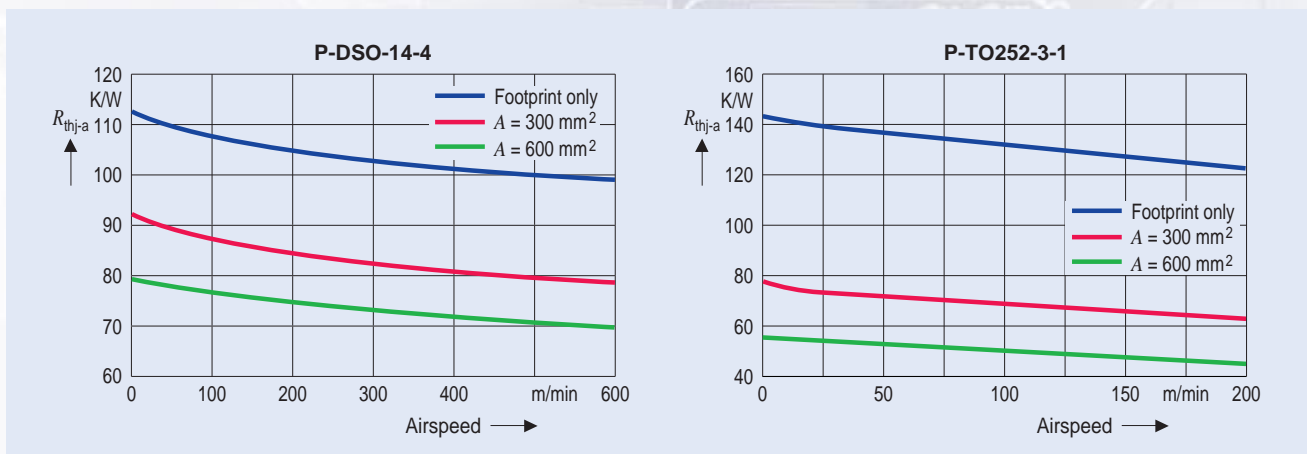

**Figure 15** Thermal Resistance Junction to Ambient  $R_{thj-a}$  vs. Airspeed for the P-DSO-14-4 and P-TO252-3-1 Packages



## Measuring the $R_{thj-a}$ in a Real Application:

Using the measurement described below the real thermal resistance can be determined.

To determine the actual  $R_{thj-a}$  the temperature difference between chip temperature  $T_j$  and ambient temperature  $T_a$  is required. The

equation  $R_{thj-a} = \frac{T_j - T_a}{P_V}$  applies.

The power loss  $P_V$  and the ambient temperature  $T_a$  can be determined easily in a temperature chamber or calculated.

To measure the chip temperature ( $T_j$ ) requires a little trick: A temperature sensor is required on the chip which can also be read during operation. In many products a substrate diode can be used at an output (Status, Reset, etc.) to measure the chip temperature. To do this, the forward voltage  $V_F$  of the diode is measured at load independent current as a calibration curve. Due to the characteristic temperature behavior of the forward voltage - it has a negative temperature coefficient of approx. -2 mV/K - the relevant chip temperature can be determined.

The calibration curve is measured in the temperature chamber with airflow. The power loss should be kept as low as possible to ensure the chip temperature remains equal to the ambient temperature. For the voltage regulator TLE 4269 GM (P-DSO-14-4 Package) a calibration curve (measured at the diode at the reset output, pin 7). RO is illustrated in **Figure 16**. **Figure 17** shows the corresponding measuring circuit.

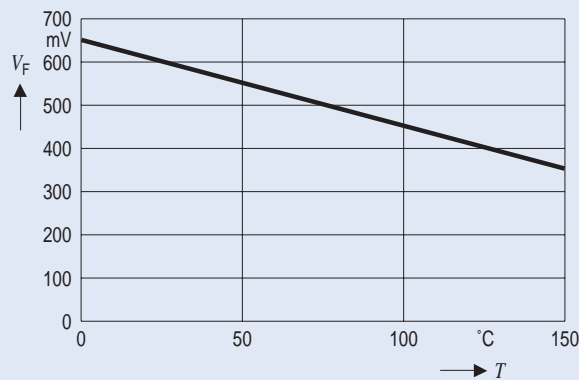

**Figure 16** Calibration Curve TLE 4269 GM for  $I_{RO} = -500 \mu A$  (current drawn from Pin 7; RO)

# Thermal Resistance - Theory and Practice

The  $R_{thj-a}$  of any application can be determined by measuring the forward voltage of an output with substrate diode during operation (**Figure 17**).

When the switch S1 is closed and the output voltage  $V_Q = 5\text{ V}$ , the output current is  $\frac{5}{35}\text{ A}$ .

The power loss  $P_V = (V_I - V_Q) \cdot I_Q$  in the chip of the voltage regulator is now 1 W. Now, change the ambient temperature  $T_a$  and measure the respective

forward voltage  $V_F$  of the diode.

The appropriate  $T_j$  for every  $V_F$  value can be read from the calibration curve  $V_F = f(T_j)$ .

The exact heat resistance of the real application is calculated with this values in the formula

$$R_{thj-a} = \frac{T_j - T_a}{P_V}$$

Parameters such as air flow can be changed without affecting the measuring accuracy.

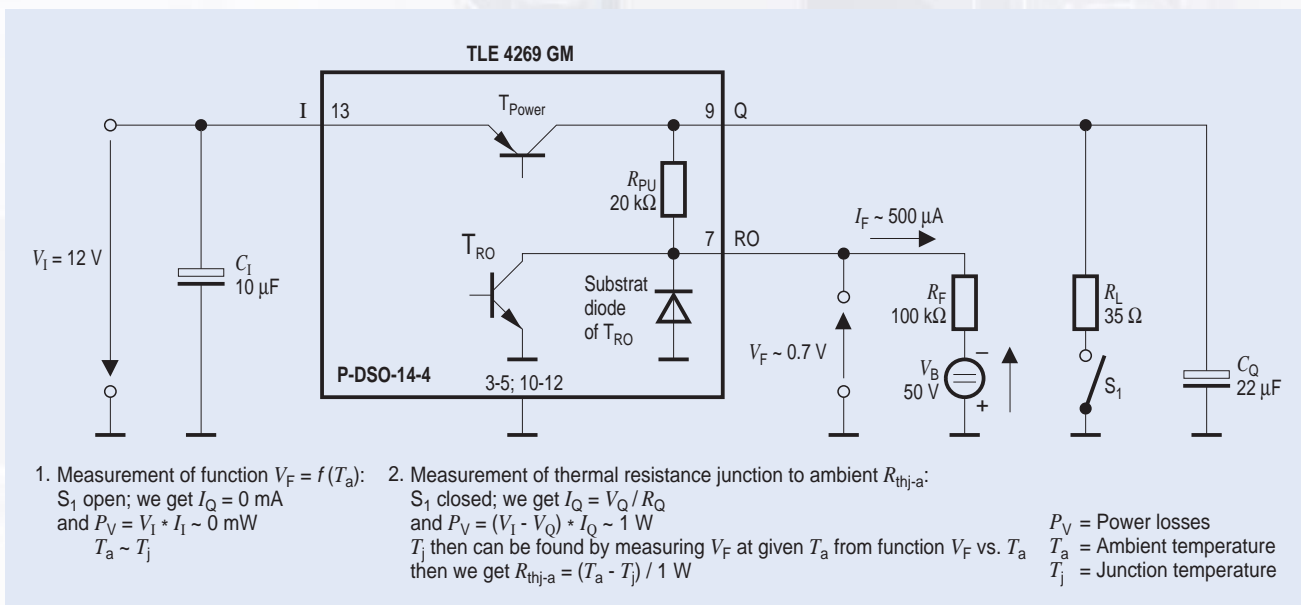

**Figure 17** Measuring Circuit with TLE 4269GM

## Determining the Dynamic Heat Resistance

The FEM analysis is used also for dynamic processes.

As described above, the dynamic thermal impedance is defined as the ratio of the temperature difference  $\Delta T = T_j - T_a$  (chip temperature - start temperature) after the time  $t_p$  to the power loss.

If a transient FEM simulation is

performed, it is easy to obtain the graph  $Z_{thj-a} = f(t_p)$  (dynamic thermal impedance as a function of the pulse width  $t_p$ ).

For the P-TO252-3-1 (D-Pack) and the P-DSO-14-4 the thermal impedances for the above-mentioned PCB configurations are specified (Figure 18).

The peak temperatures can be calculated easily from these curves:

- P-TO252-3-1 (D-Pack)
- 3 cm<sup>2</sup> heat sink
- Power loss  $P_V = 10$  W
- Pulse width  $t_p = 200$  ms
- Ambient temperature  $T_a = 85$  °C.

From the middle curve (Figure 18), the  $Z_{thj-a}$  of approximately 3.5 K/W at  $t_p = 200$  ms gives a temperature rise  $\Delta T = P_V \times Z_{thj-a}$  of 35 K and finally a peak temperature  $T_{jmax}$  of 85 °C+35 °C = 120 °C.

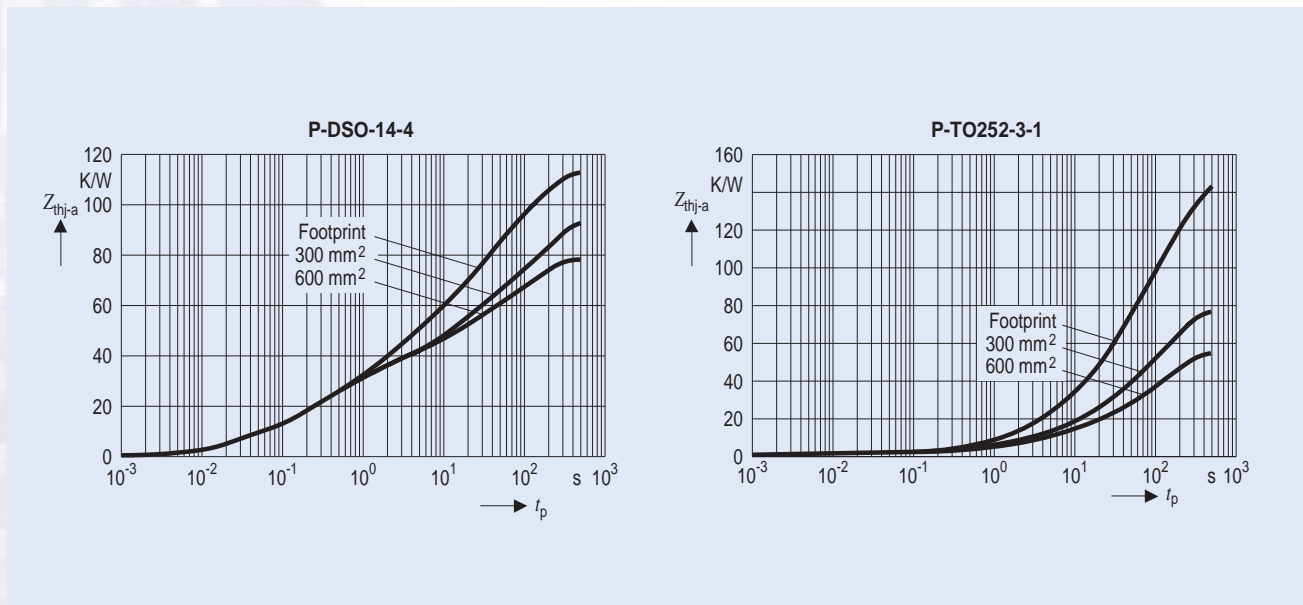

**Figure 18** Thermal Impedance Junction to Ambient  $Z_{thj-a}$  vs. Single Pulse Time  $t_p$

## Summary

For each case listed in **Table 1**, a „**Package and Thermal Information**“ data sheet is provided in the appendix. Each data sheet shows the footprint and case dimensions. The various versions of the PCBs used for the simulation are shown. It shows the heat distribution diagrams and the result diagrams of the FEM simulation. The left side shows the diagram of the static thermal resistance  $R_{thj-a}$  depending on the PCB heat sink area  $A$ . It includes the related thermal resistance  $R_{thj-c}$  (junction-case) or  $R_{thj-pin}$ .

On the right side is the diagram for the dynamic heat resistance  $Z_{thj-a}$ , with three graphs for the various PCB heat sinks depending on the single pulse duration  $t_p$ . This information is a valuable aid for SMD Power applications. It is intentionally limited to PCBs laminated on one side because it represents the cost optimum. For double sided PCBs or multilayers a simple attempt with conductance cross sections can be made to determine the change in the PCB thermal resistance (compare thermal data sheet of

P-DSO-20-10 with P-DSO-36-10 in the appendix).

The PCBs are usually installed in closed plastic cases. The most favorable heat path then usually forms at plug contacts to the cables because a supply wire with an adequate cross section is ideal as a heat conductor.

The future of chip placement requires mechatronic solutions where the PCB can be replaced by chip-connector-supply wire configurations.

# Appendix

	P-DSO-8-1	22
	P-DSO-14-4	23
	P-DSO-16-1	24
	P-DSO-20-1	25
	P-DSO-20-6	26
	P-DSO-24-3	27
	P-DSO-28-6	28
	P-DSO-20-10	29
	P-DSO-36-10	30
	SCT595-5-1	31
	SOT223-4-2	32
	P-T0252-3-1	33
	P-T0263-5-1	34



# P-DSO-8-1

## Footprint/Dimensions

Package	$e$	$A$	$L$	$B$
P-DSO-8-1	1.27	5.69	1.31	0.65

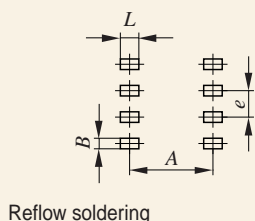

Reflow soldering

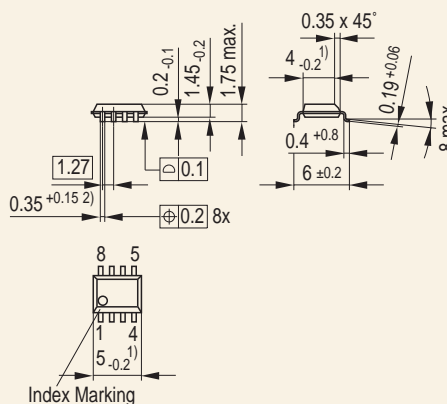

Index Marking



Dimensions in mm

## PC-Board

## Application-Boards for $R_{th}$ - Measurement

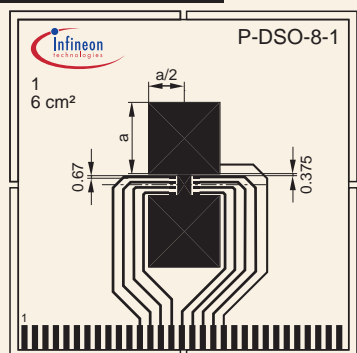

FR4; 80 x 80 x 1.5 mm; 35  $\mu$  Cu, 5  $\mu$  Sn  
A = 600 mm<sup>2</sup>; a = 17.32 mm

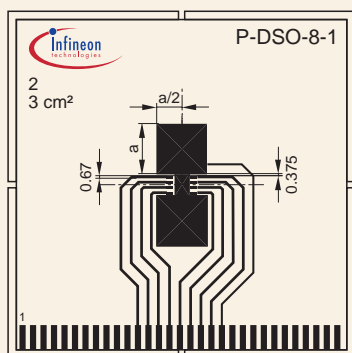

FR4; 80 x 80 x 1.5 mm; 35  $\mu$  Cu, 5  $\mu$  Sn  
A = 300 mm<sup>2</sup>; a = 12.247 mm

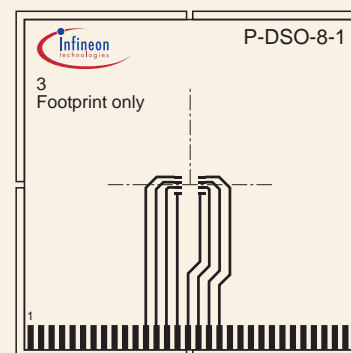

FR4; 80 x 80 x 1.5 mm; 35  $\mu$  Cu, 5  $\mu$  Sn  
Footprint only

## Finite Element Method

FEM Simulation (chip area  $\geq 2$  mm<sup>2</sup>;  $P_v = 0.5$  W; zero airflow)

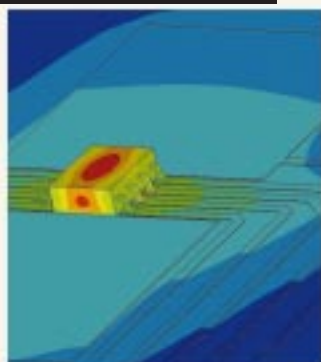

A = 600 mm<sup>2</sup>;  $T_a = 298$  K;  $T_{max} = 369$  K

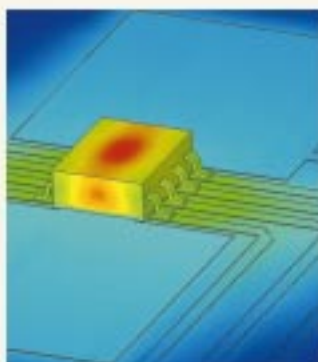

A = 300 mm<sup>2</sup>;  $T_a = 298$  K;  $T_{max} = 380$  K

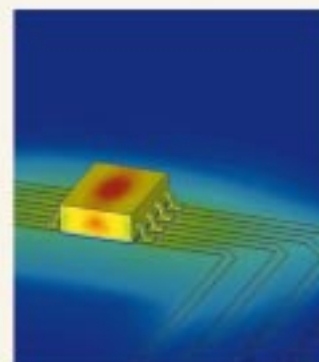

Footprint only;  $T_a = 298$  K;  $T_{max} = 390$  K

## Diagrams

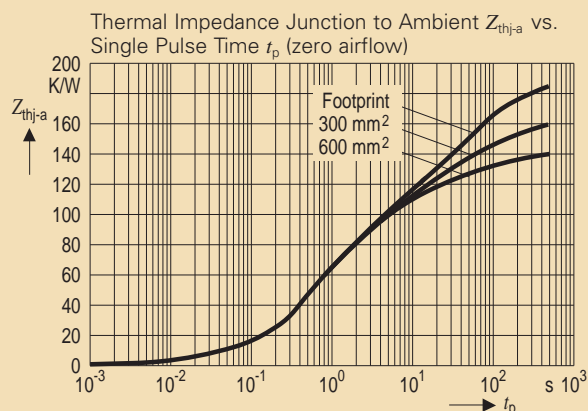
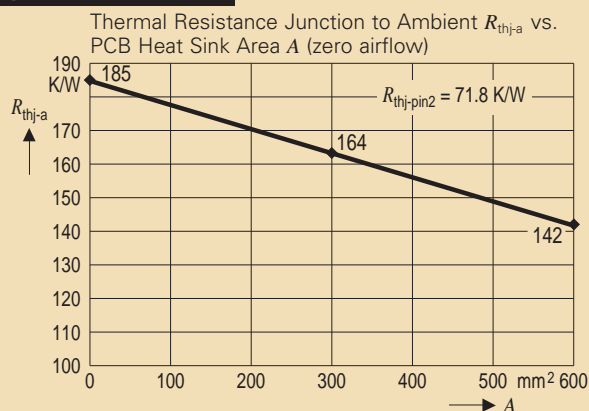

# Package and Thermal Information



## P-DSO-14-4

### Footprint/Dimensions

Package	$e$	$A$	$L$	$B$
P-DSO-14-4	1.27	5.69	1.31	0.65

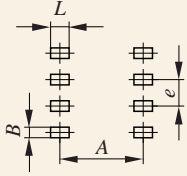

Reflow soldering

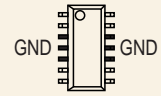
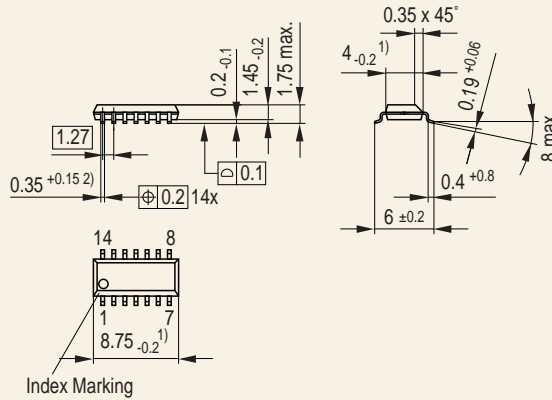

Dimensions in mm

### Application-Boards for $R_{th}$ - Measurement

### PC-Board

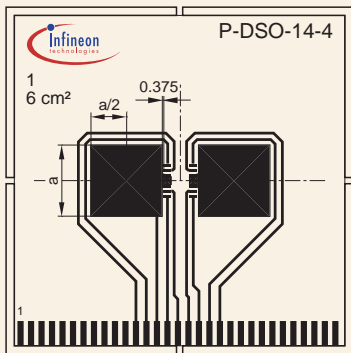

FR4; 80x80x1.5 mm; 35  $\mu$  Cu, 5  $\mu$  Sn  
A = 600 mm<sup>2</sup>; a = 17.32 mm

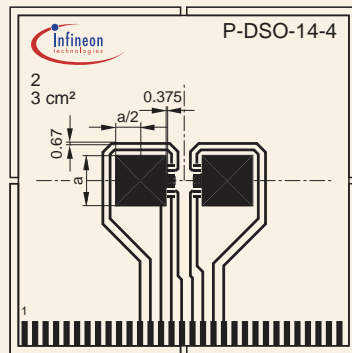

FR4; 80x80x1.5 mm; 35  $\mu$  Cu, 5  $\mu$  Sn  
A = 300 mm<sup>2</sup>; a = 12.247 mm

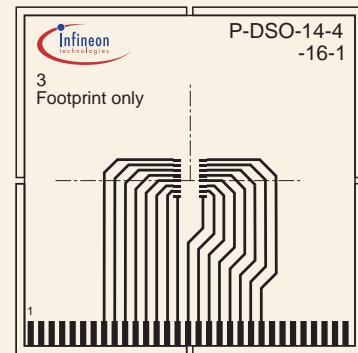

FR4; 80x80x1.5 mm; 35  $\mu$  Cu, 5  $\mu$  Sn  
Footprint only

### FEM Simulation (chip area $\geq 2$ mm<sup>2</sup>; $P_v = 1$ W; zero airflow)

### Finite Element Method

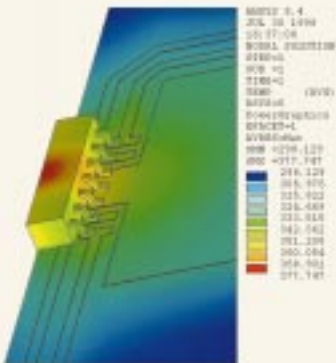

A = 600 mm<sup>2</sup>;  $T_a = 298.1$  K;  $T_{max} = 377.7$  K

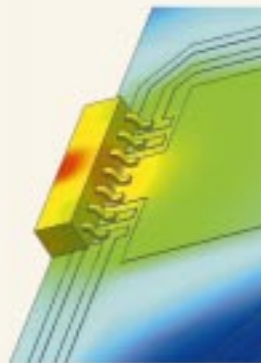

A = 300 mm<sup>2</sup>;  $T_a = 298$  K;  $T_{max} = 389.8$  K

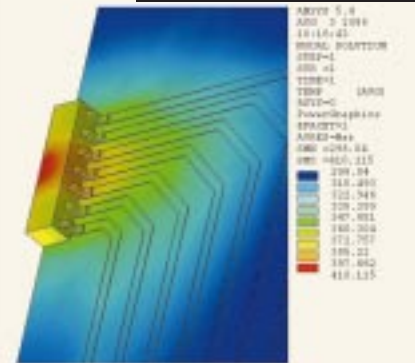

Footprint only;  $T_a = 298$  K;  $T_{max} = 410.1$  K

### Diagrams

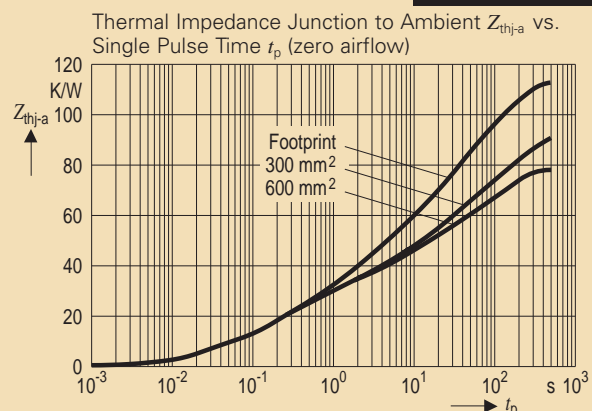
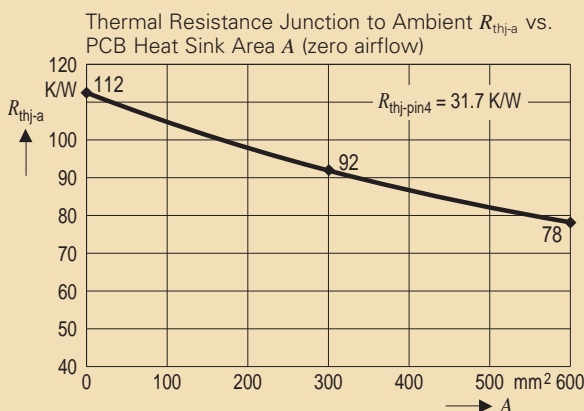

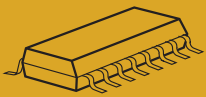

# P-DSO-16-1

## Footprint/Dimensions

Package	$e$	$A$	$L$	$B$
P-DSO-16-1	1.27	5.69	1.31	0.65

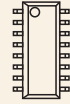
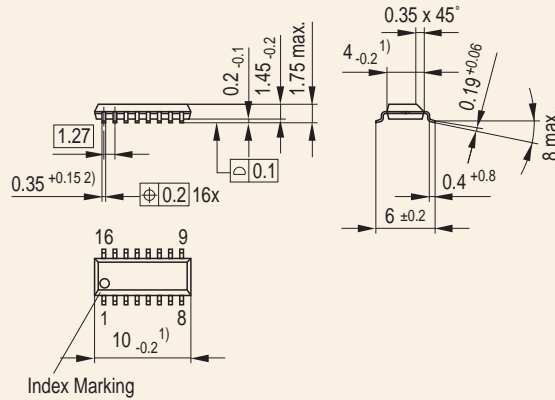
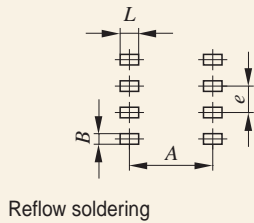

Dimensions in mm

## PC-Board

### Application-Board for $R_{th}$ - Measurement

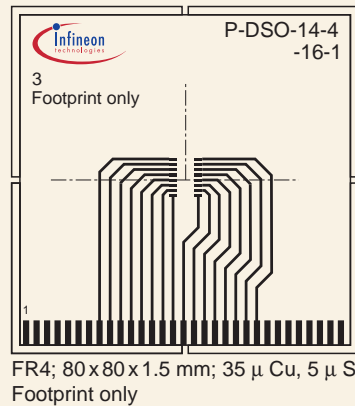

## Finite Element Method

FEM Simulation (chip area  $\geq 2$  mm<sup>2</sup>;  $P_v = 1$  W; zero airflow)

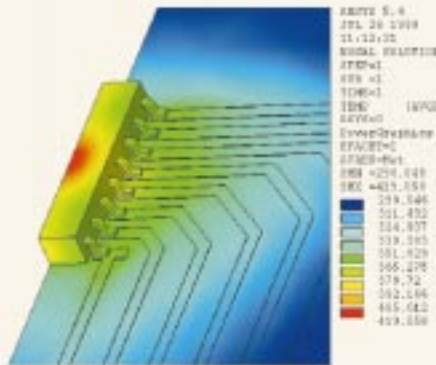

## Diagrams

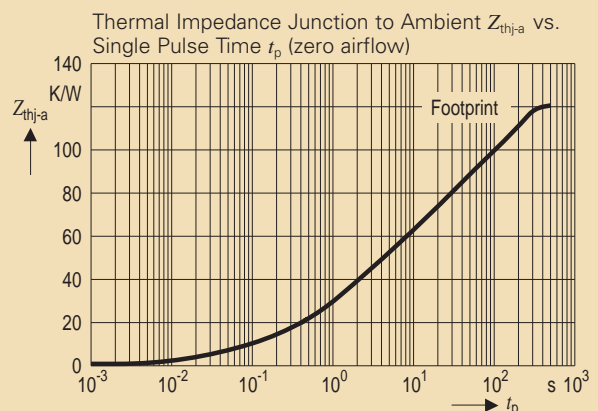
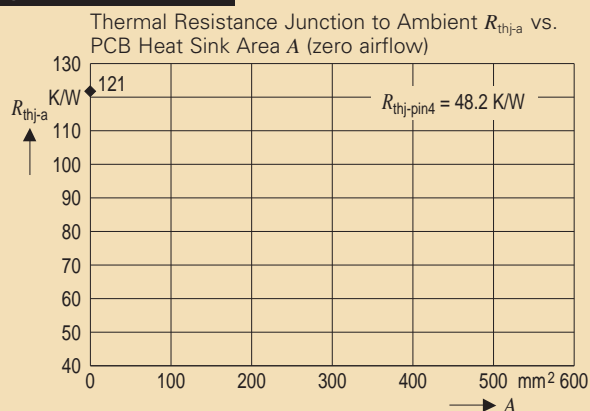



# Package and Thermal Information

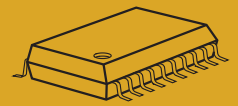

## P-DSO-20-1

### Footprint/Dimensions

Package	$e$	$A$	$L$	$B$
P-DSO-20-1	1.27	9.73	1.67	0.65

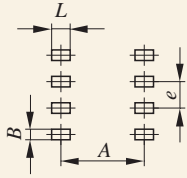

Reflow soldering

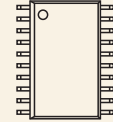
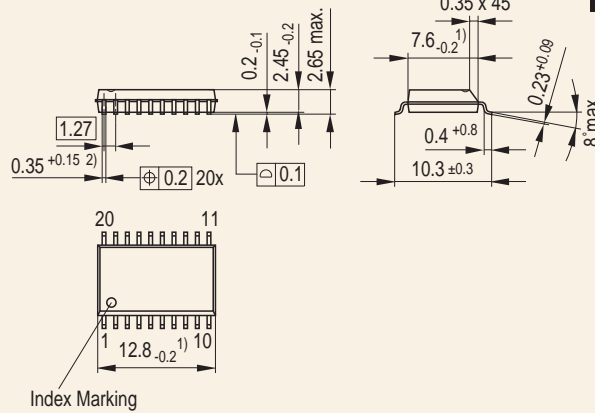

Dimensions in mm

### Application-Board for $R_{th}$ - Measurement

### PC-Board

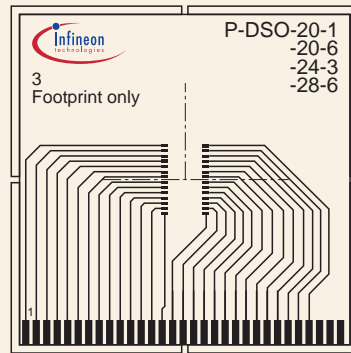

FR4; 80x80x1.5 mm; 35  $\mu$  Cu, 5  $\mu$  Sn  
Footprint only

### FEM Simulation (chip area $\geq 2$ mm<sup>2</sup>; $P_v = 1$ W; zero airflow)

### Finite Element Method

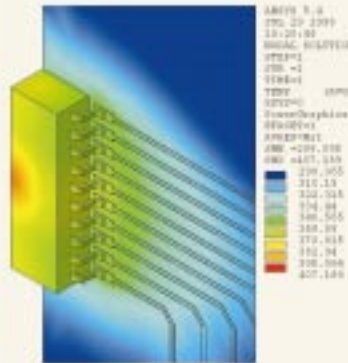

Footprint only;  $T_a = 298$  K;  $T_{max} = 407$  K

### Diagrams

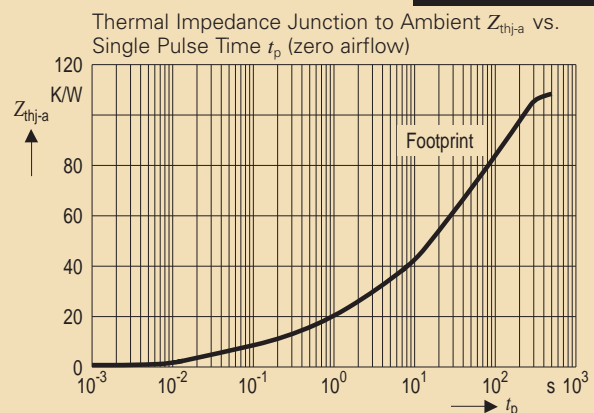
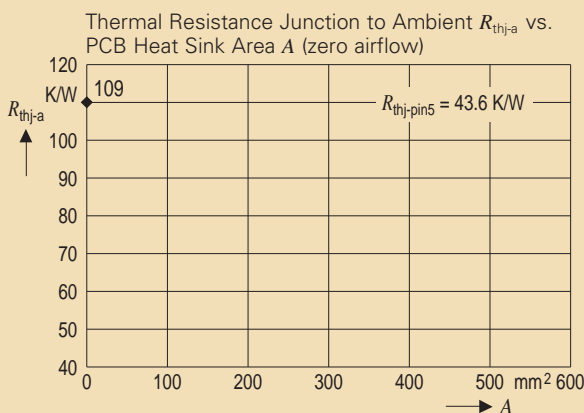

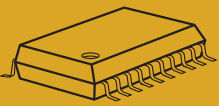

# P-DSO-20-6

## Footprint/Dimensions

Package	<i>e</i>	<i>A</i>	<i>L</i>	<i>B</i>
P-DSO-20-6	1.27	9.73	1.67	0.65

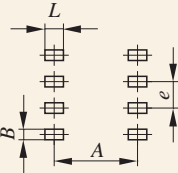

Reflow soldering

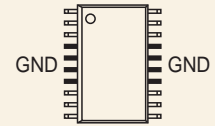
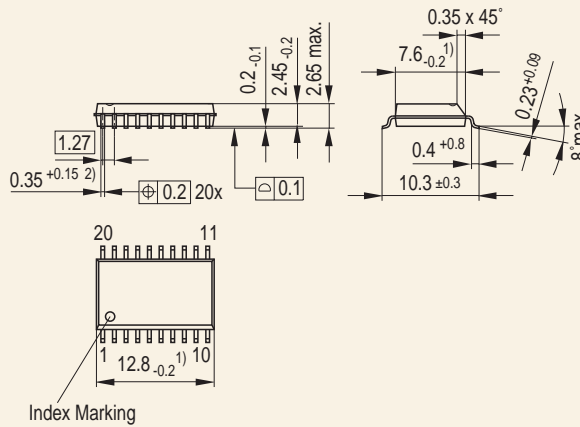

Dimensions in mm

## PC-Board

## Application-Boards for $R_{th}$ - Measurement

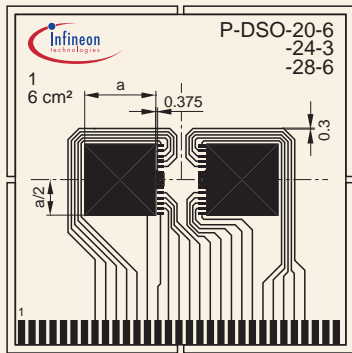

FR4; 80x80x1.5 mm; 35  $\mu$  Cu, 5  $\mu$  Sn  
A = 600 mm<sup>2</sup>; a = 17.32 mm

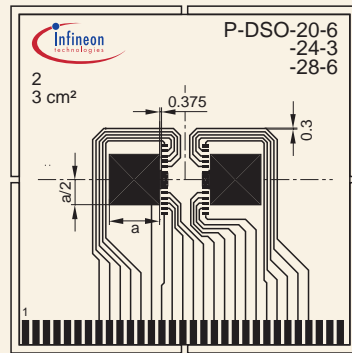

FR4; 80x80x1.5 mm; 35  $\mu$  Cu, 5  $\mu$  Sn  
A = 300 mm<sup>2</sup>; a = 12.247 mm

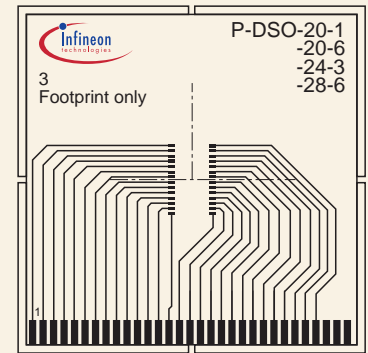

FR4; 80x80x1.5 mm; 35  $\mu$  Cu, 5  $\mu$  Sn  
Footprint only

## Finite Element Method

FEM Simulation (chip area  $\geq 2$  mm<sup>2</sup>;  $P_v = 1$  W; zero airflow)

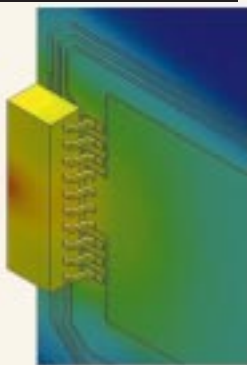

A = 600 mm<sup>2</sup>;  $T_a = 298$  K;  $T_{max} = 372$  K

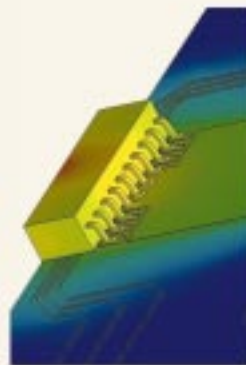

A = 300 mm<sup>2</sup>;  $T_a = 298$  K;  $T_{max} = 379$  K

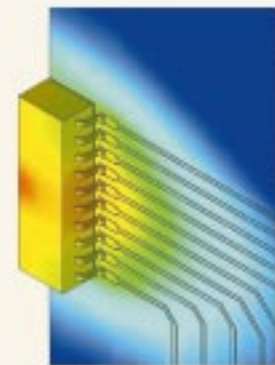

Footprint only;  $T_a = 298$  K;  $T_{max} = 397$  K

## Diagrams

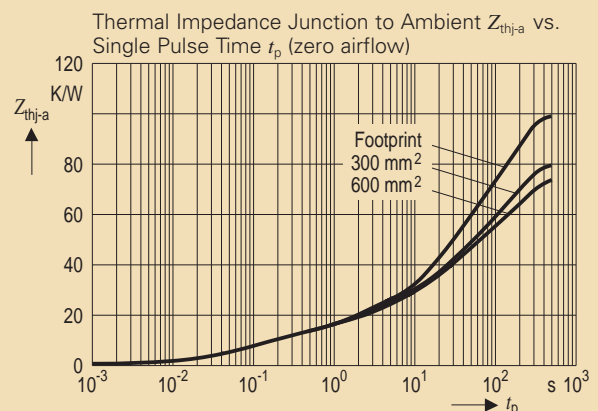
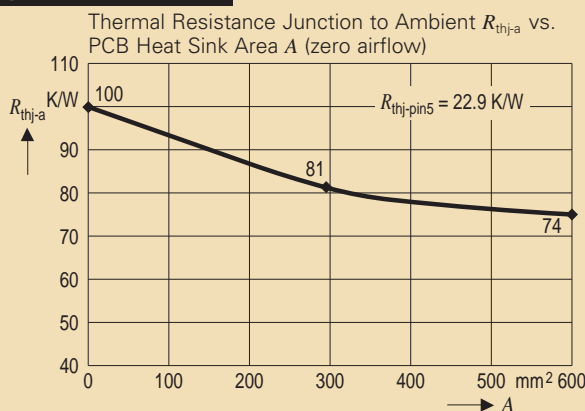

# Package and Thermal Information

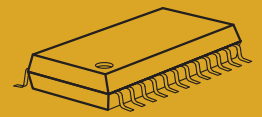

## P-DSO-24-3

### Footprint/Dimensions

Package	$e$	$A$	$L$	$B$
P-DSO-24-3	1.27	9.73	1.67	0.65

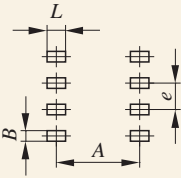

Reflow soldering

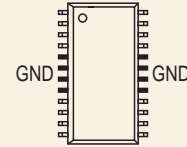
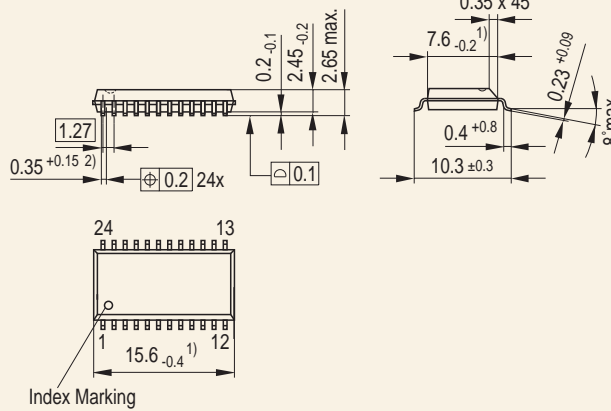

Dimensions in mm

### Application-Boards for $R_{th}$ - Measurement

### PC-Board

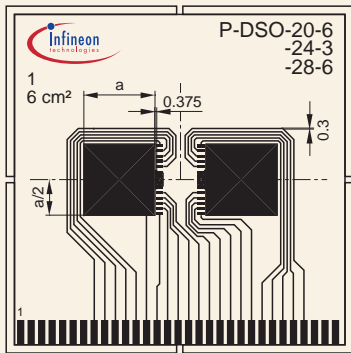

FR4; 80x80x1.5 mm; 35  $\mu$  Cu, 5  $\mu$  Sn  
A = 600 mm<sup>2</sup>; a = 17.32 mm

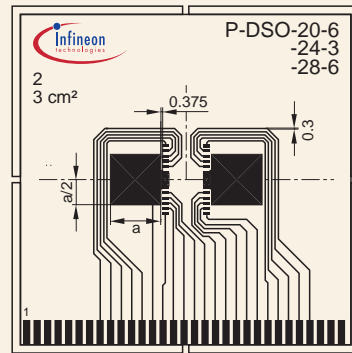

FR4; 80x80x1.5 mm; 35  $\mu$  Cu, 5  $\mu$  Sn  
A = 300 mm<sup>2</sup>; a = 12.247 mm

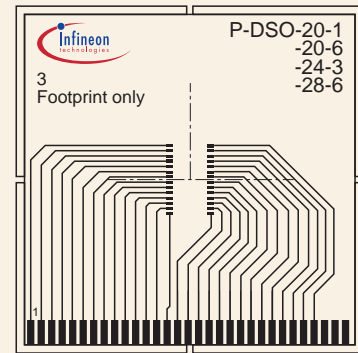

FR4; 80x80x1.5 mm; 35  $\mu$  Cu, 5  $\mu$  Sn  
Footprint only

### FEM Simulation (chip area $\geq 2$ mm<sup>2</sup>; $P_V = 1$ W; zero airflow)

### Finite Element Method

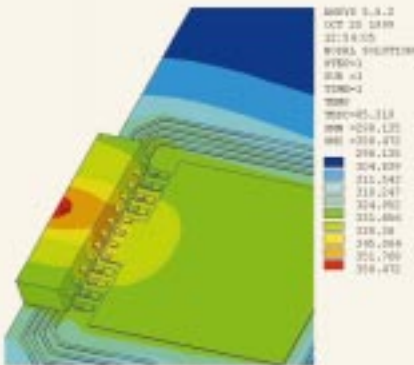

A = 600 mm<sup>2</sup>;  $T_a = 298$  K;  $T_{max} = 358$  K

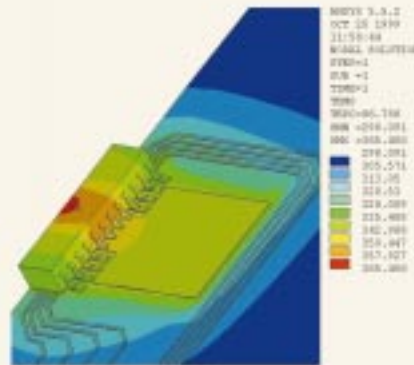

A = 300 mm<sup>2</sup>;  $T_a = 298$  K;  $T_{max} = 365$  K

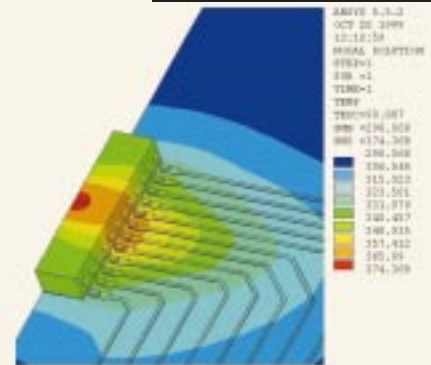

Footprint only;  $T_a = 298$  K;  $T_{max} = 374$  K

### Diagrams

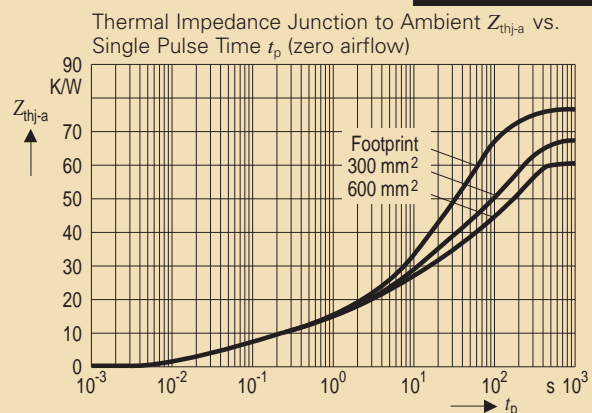
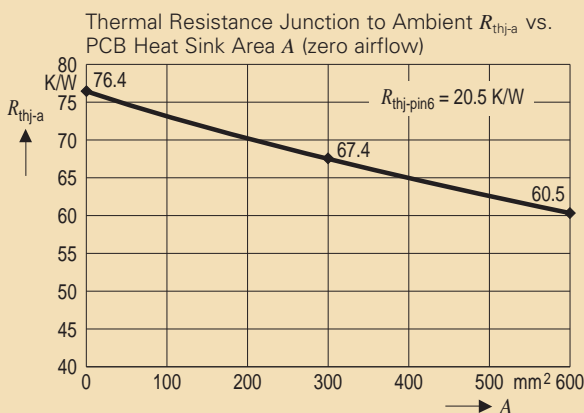

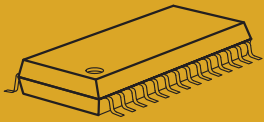

# P-DSO-28-6

## Footprint/Dimensions

Package	e	A	L	B
P-DSO-28-6	1.27	9.73	1.67	0.65

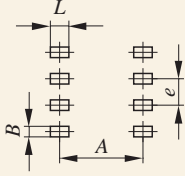

Reflow soldering

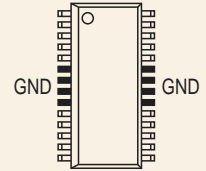
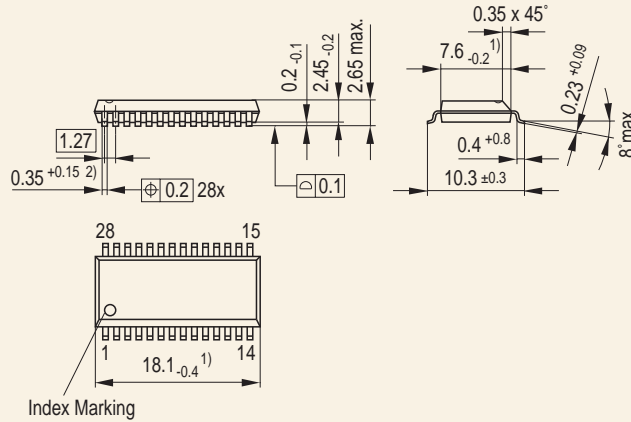

Dimensions in mm

## PC-Board

## Application-Boards for $R_{th}$ - Measurement

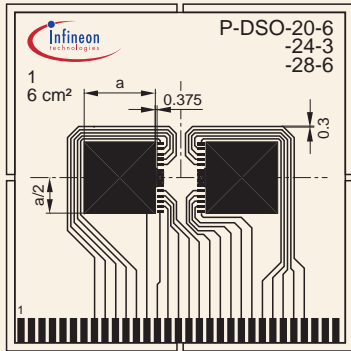

FR4; 80 x 80 x 1.5 mm; 35  $\mu$  Cu, 5  $\mu$  Sn  
A = 600 mm<sup>2</sup>; a = 17.32 mm

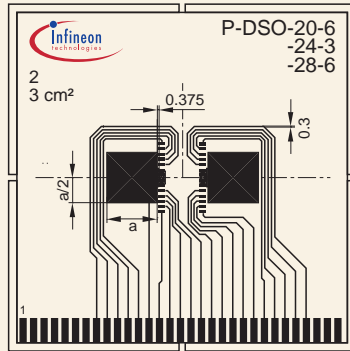

FR4; 80 x 80 x 1.5 mm; 35  $\mu$  Cu, 5  $\mu$  Sn  
A = 300 mm<sup>2</sup>; a = 12.247 mm

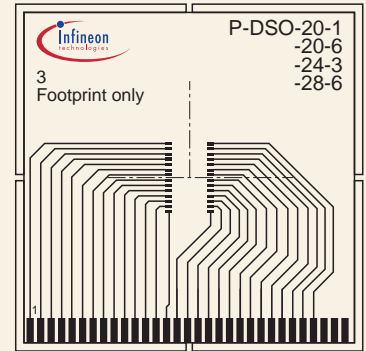

FR4; 80 x 80 x 1.5 mm; 35  $\mu$  Cu, 5  $\mu$  Sn  
Footprint only

## Finite Element Method

FEM Simulation (chip area  $\geq 2$  mm<sup>2</sup>;  $P_V = 1$  W; zero airflow)

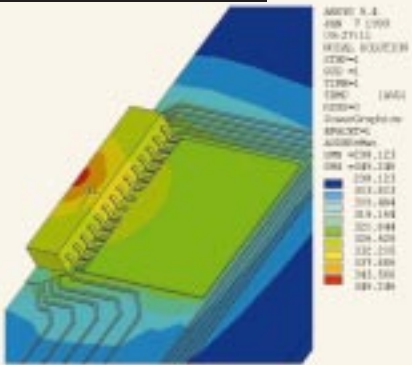

A = 600 mm<sup>2</sup>;  $T_a = 298$  K;  $T_{max} = 349$  K

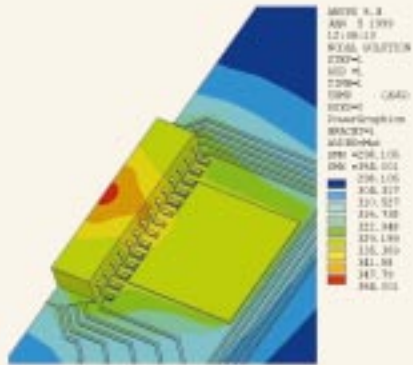

A = 300 mm<sup>2</sup>;  $T_a = 298$  K;  $T_{max} = 354$  K

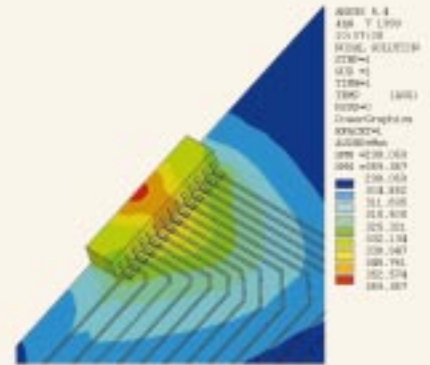

Footprint only;  $T_a = 298$  K;  $T_{max} = 359$  K

## Diagrams

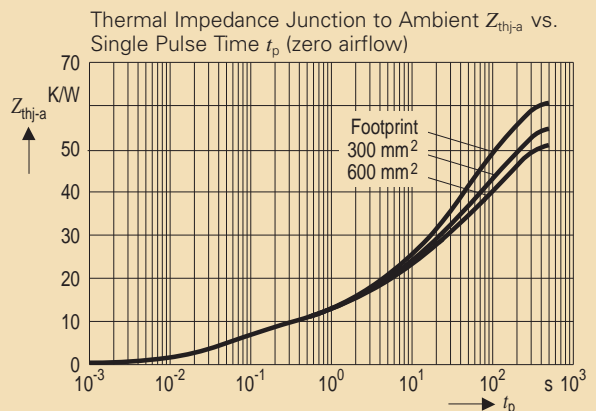
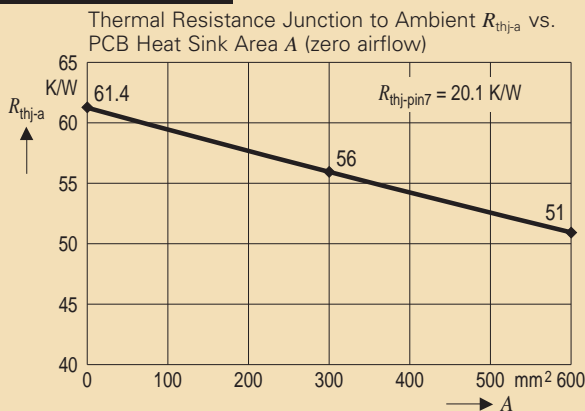

# Package and Thermal Information



## P-DSO-20-10

### Footprint/Dimensions

Package	<i>e</i>	<i>A</i>	<i>L</i>	<i>B</i>
P-DSO-20-10	1.27	13.48	1.83	0.68

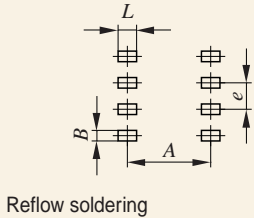

Reflow soldering

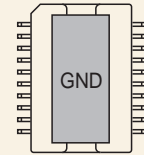
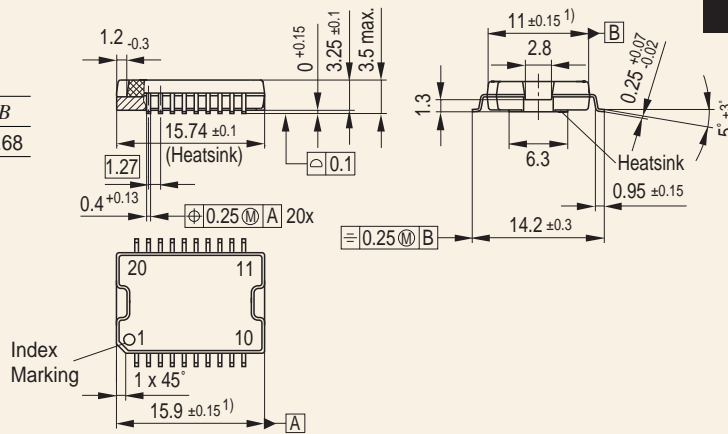

Dimensions in mm

### Application-Boards for $R_{th}$ - Measurement

### PC-Board

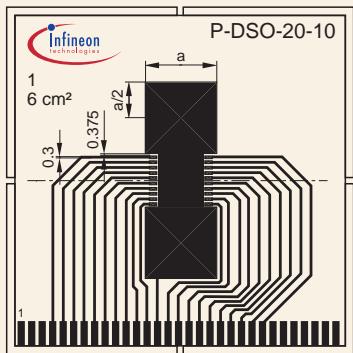

FR4; 80x80x1.5 mm; 35  $\mu$  Cu, 5  $\mu$  Sn  
A = 600 mm<sup>2</sup>; a = 17.32 mm

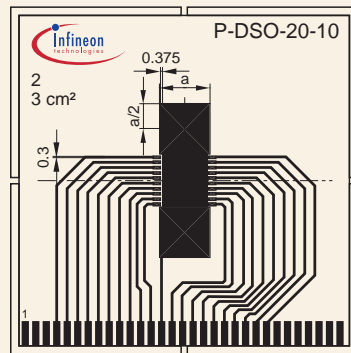

FR4; 80x80x1.5 mm; 35  $\mu$  Cu, 5  $\mu$  Sn  
A = 300 mm<sup>2</sup>; a = 12.247 mm

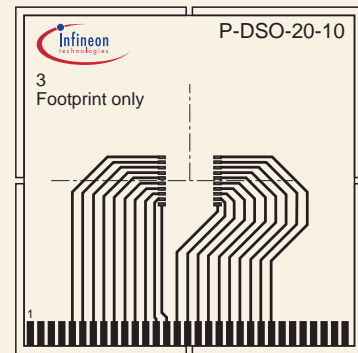

FR4; 80x80x1.5 mm; 35  $\mu$  Cu, 5  $\mu$  Sn  
Footprint only

### FEM Simulation (chip area $\geq 2$ mm<sup>2</sup>; $P_V = 3$ W; zero airflow)

### Finite Element Method

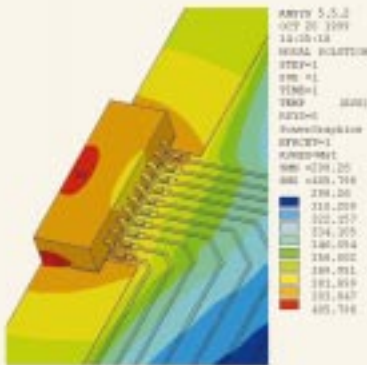

A = 600 mm<sup>2</sup>;  $T_a = 298$  K;  $T_{max} = 406$  K

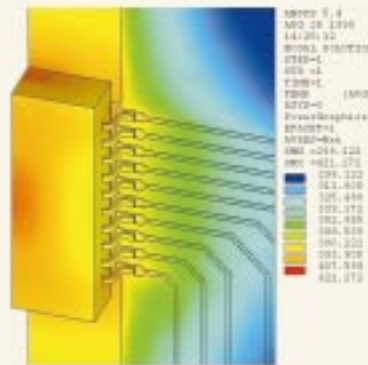

A = 300 mm<sup>2</sup>;  $T_a = 298$  K;  $T_{max} = 421$  K

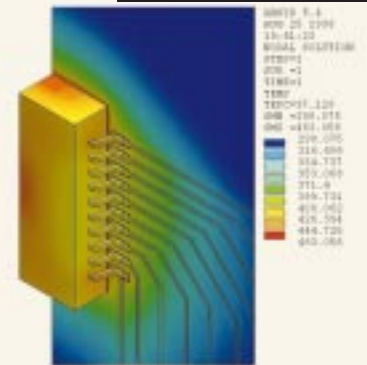

Footprint only;  $T_a = 298$  K;  $T_{max} = 463$  K

### Diagrams

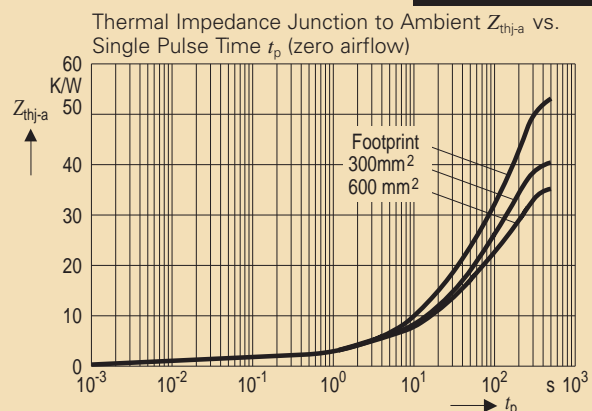
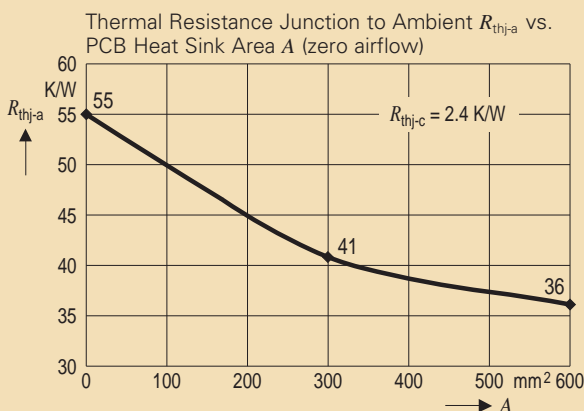



# P-DSO-36-10

## Footprint/Dimensions

Package	$e$	$A$	$L$	$B$
P-DSO-36-10	0.65	13.48	1.83	0.45

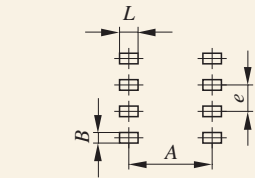

Reflow soldering

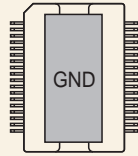
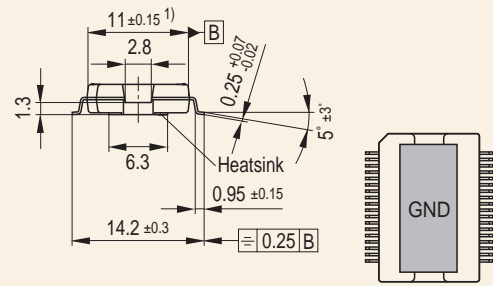
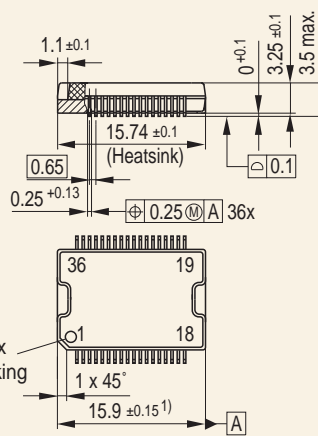

Dimensions in mm

## PC-Board

### Application-Boards for $R_{th}$ - Measurement

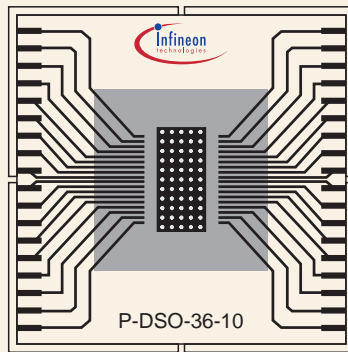

FR4; 47 x 50 x 1.5 mm; 70  $\mu$  Cu  
 $A = 600 \text{ mm}^2$ ; 24.5 x 24.5 mm

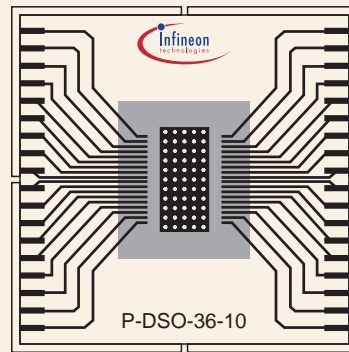

FR4; 47 x 50 x 1.5 mm; 70  $\mu$  Cu  
 $A = 300 \text{ mm}^2$ ; 16 x 19 mm

## Finite Element Method

FEM Simulation (chip area  $\geq 2 \text{ mm}^2$ ;  $P_v = 3.5 \text{ W}$ ; zero airflow)

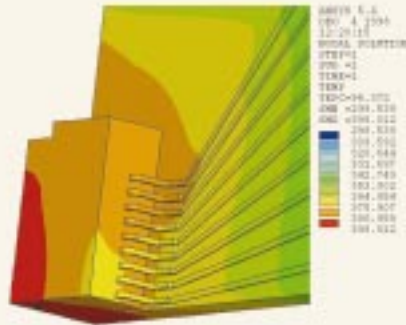

$A = 600 \text{ mm}^2$ ;  $T_a = 298 \text{ K}$ ;  $T_{max} = 398 \text{ K}$

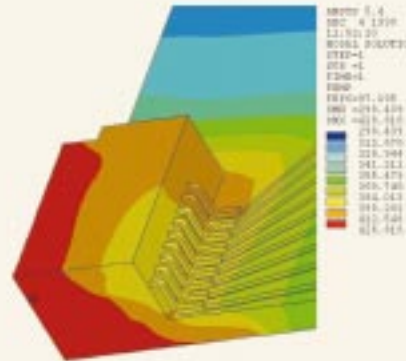

$A = 300 \text{ mm}^2$ ;  $T_a = 298 \text{ K}$ ;  $T_{max} = 427 \text{ K}$

## Diagrams

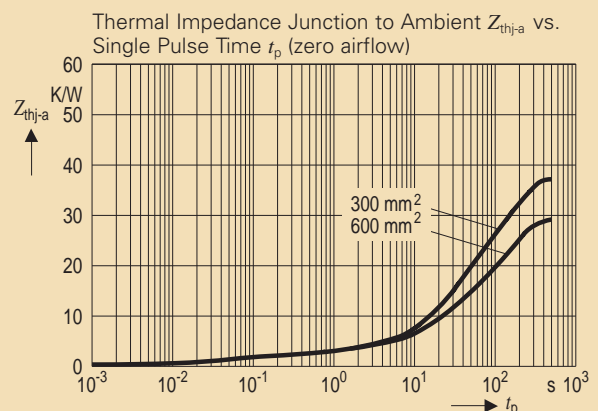
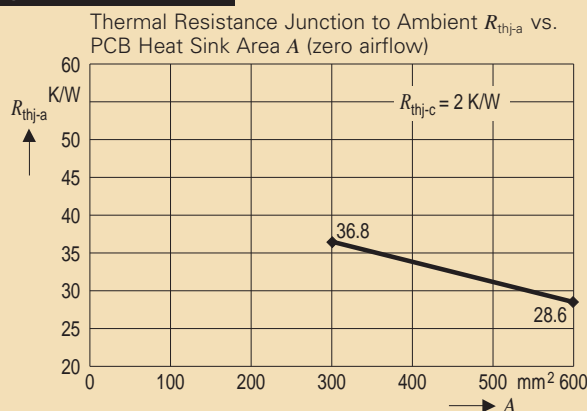



### Footprint/Dimensions

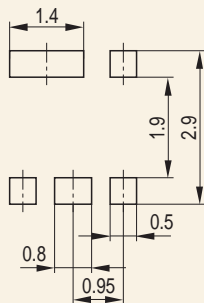

Reflow soldering

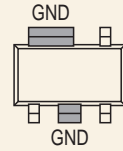
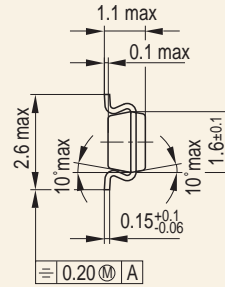
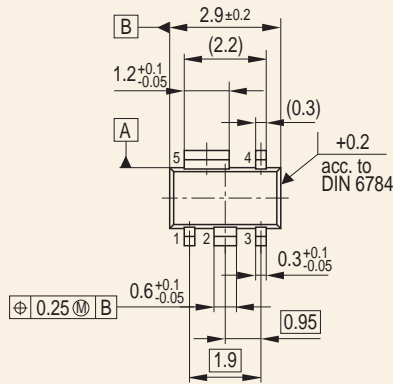

Dimensions in mm

### Application-Boards for $R_{th}$ - Measurement

### PC-Board

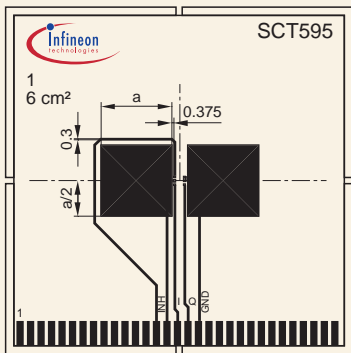

FR4; 80x80x1.5 mm; 35  $\mu$  Cu, 5  $\mu$  Sn  
A = 600 mm<sup>2</sup>; a = 17.32 mm

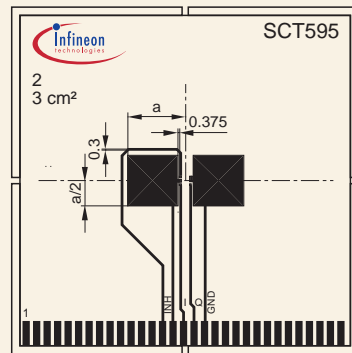

FR4; 80x80x1.5 mm; 35  $\mu$  Cu, 5  $\mu$  Sn  
A = 300 mm<sup>2</sup>; a = 12.247 mm

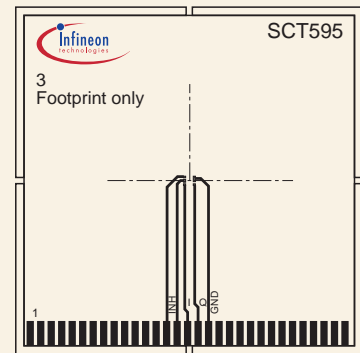

FR4; 80x80x1.5 mm; 35  $\mu$  Cu, 5  $\mu$  Sn  
Footprint only

### FEM Simulation (chip area $\geq 2$ mm<sup>2</sup>; $P_v = 0.2$ W; zero airflow)

### Finite Element Method



A = 600 mm<sup>2</sup>;  $T_a = 298$  K;  $T_{max} = 315$  K



A = 300 mm<sup>2</sup>;  $T_a = 298$  K;  $T_{max} = 318$  K

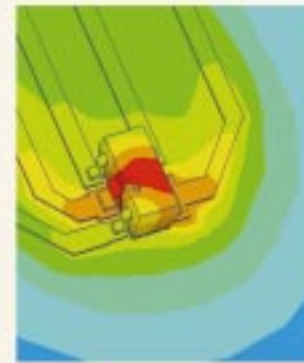

Footprint only;  $T_a = 298$  K;  $T_{max} = 334$  K

### Diagrams

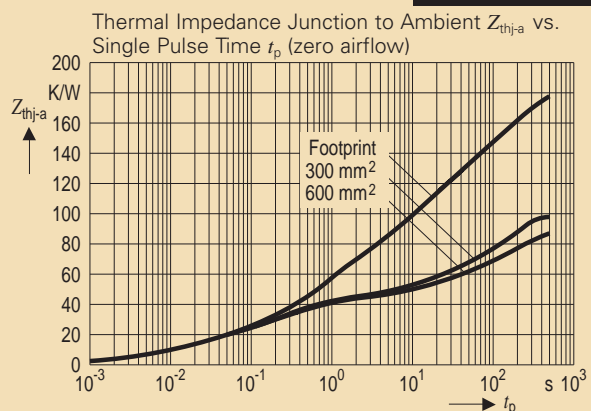
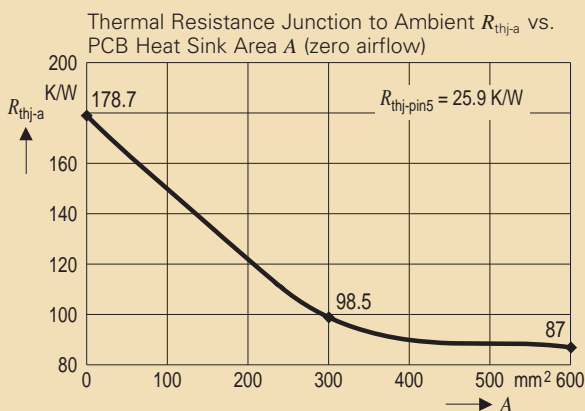



# SOT223-4-2

## Footprint/Dimensions

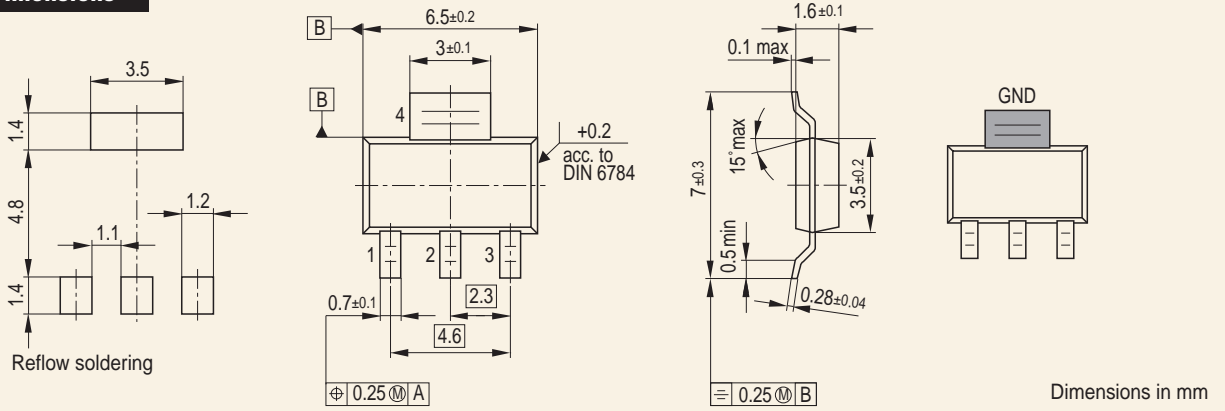

## PC-Board

## Application-Boards for $R_{th}$ - Measurement

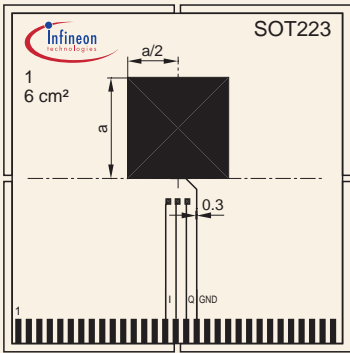

FR4; 80x80x1.5 mm; 35 µm Cu, 5 µm Sn  
A = 600 mm²; a = 24.49 mm

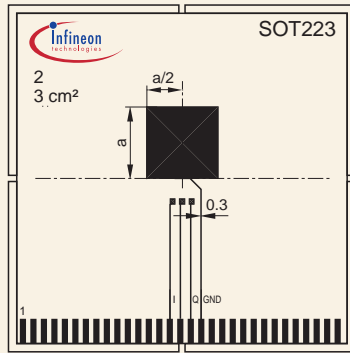

FR4; 80x80x1.5 mm; 35 µm Cu, 5 µm Sn  
A = 300 mm²; a = 17.32 mm

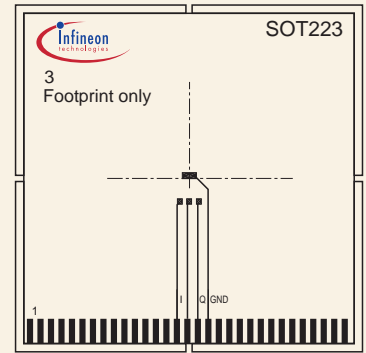

FR4; 80x80x1.5 mm; 35 µm Cu, 5 µm Sn  
Footprint only

## Finite Element Method

FEM Simulation (chip area  $\geq 2 \text{ mm}^2$ ;  $P_v = 0.5 \text{ W}$ ; zero airflow)

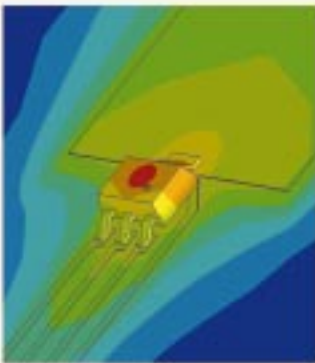

A = 600 mm²;  $T_a = 298 \text{ K}$ ;  $T_{max} = 332 \text{ K}$

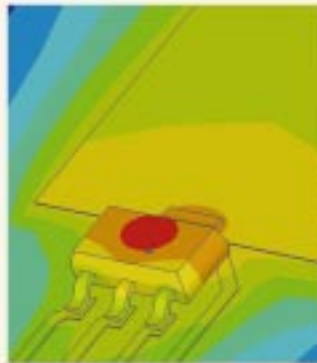

A = 300 mm²;  $T_a = 298 \text{ K}$ ;  $T_{max} = 339 \text{ K}$

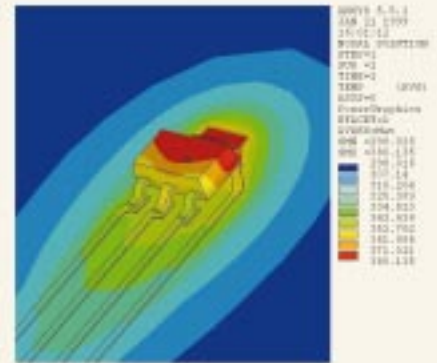

Footprint only;  $T_a = 298 \text{ K}$ ;  $T_{max} = 380 \text{ K}$

## Diagrams

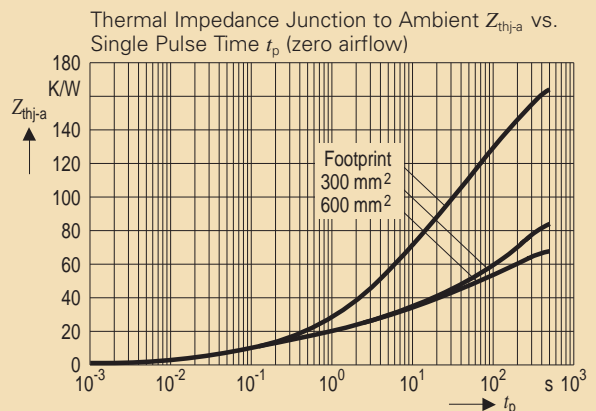
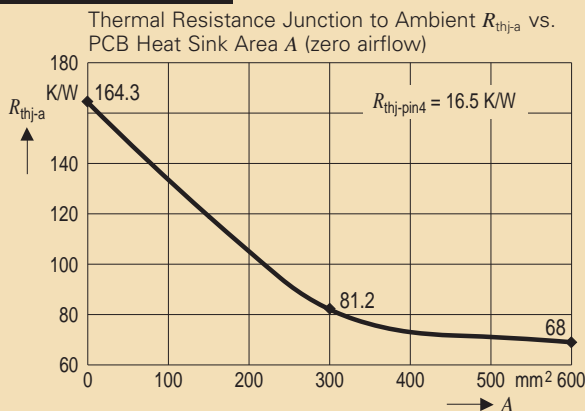



# Package and Thermal Information

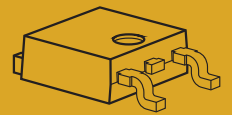

P-T0252-3-1

## Footprint/Dimensions

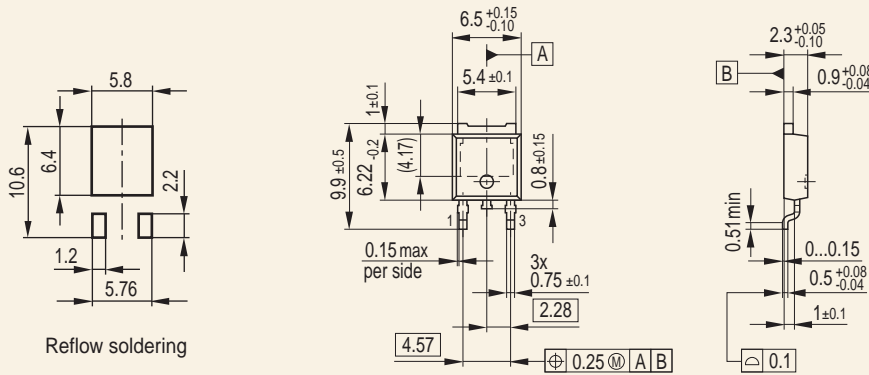

Reflow soldering

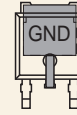

Dimensions in mm

## Application-Boards for $R_{th}$ - Measurement

## PC-Board

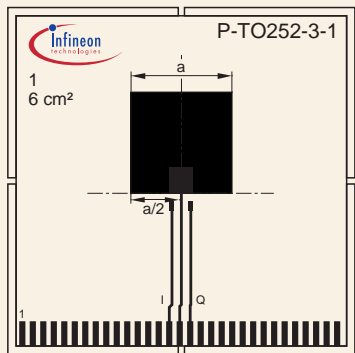

FR4; 80x80x1.5 mm; 35  $\mu$  Cu, 5  $\mu$  Sn  
A = 600 mm<sup>2</sup>; a = 24.49 mm

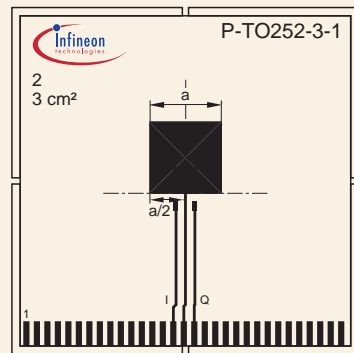

FR4; 80x80x1.5 mm; 35  $\mu$  Cu, 5  $\mu$  Sn  
A = 300 mm<sup>2</sup>; a = 17.32 mm

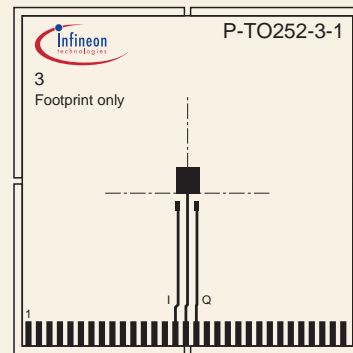

FR4; 80x80x1.5 mm; 35  $\mu$  Cu, 5  $\mu$  Sn  
Footprint only

## FEM Simulation (chip area $\geq 2$ mm<sup>2</sup>; $P_v = 1$ W; zero airflow)

## Finite Element Method

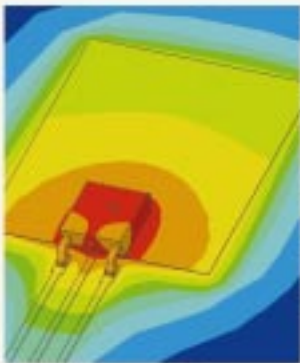

A = 600 mm<sup>2</sup>;  $T_a = 298$  K;  $T_{max} = 353$  K

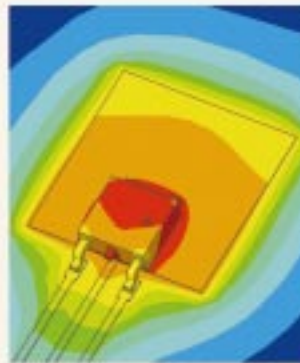

A = 300 mm<sup>2</sup>;  $T_a = 298$  K;  $T_{max} = 376$  K



Footprint only;  $T_a = 298$  K;  $T_{max} = 442$  K

## Diagrams

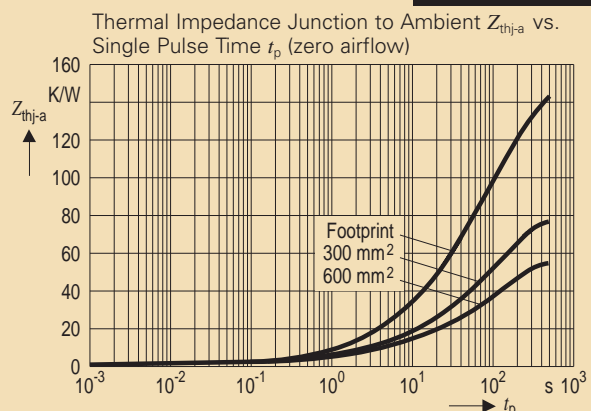
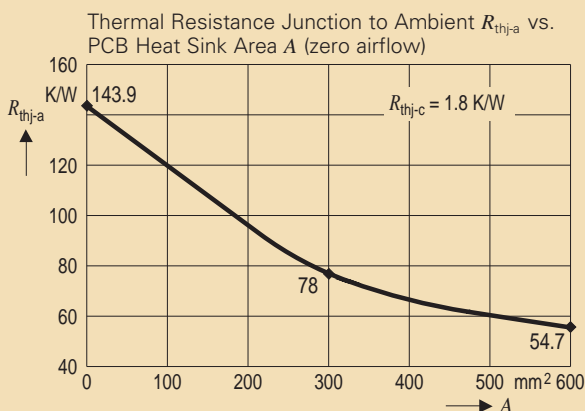

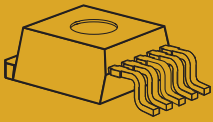

# P-T0263-5-1

## Footprint/Dimensions

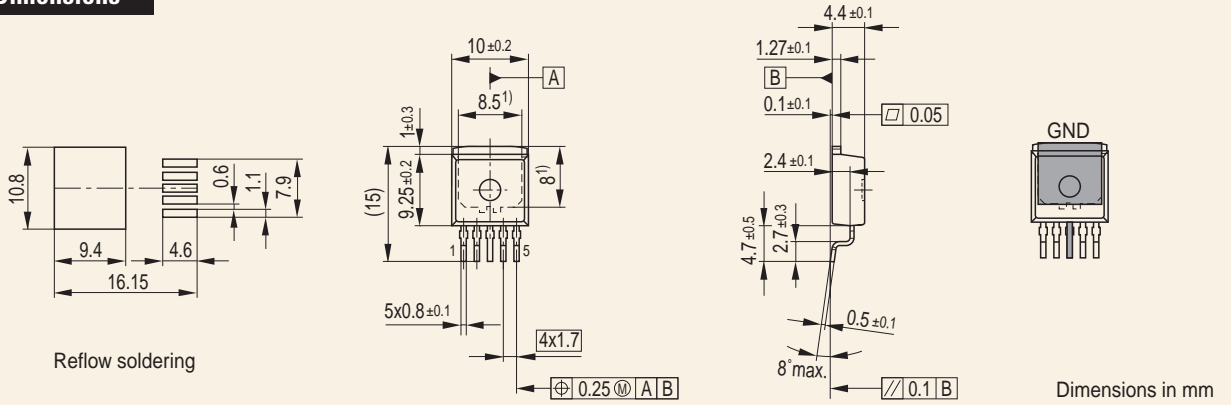

## PC-Board

## Application-Boards for $R_{th}$ - Measurement

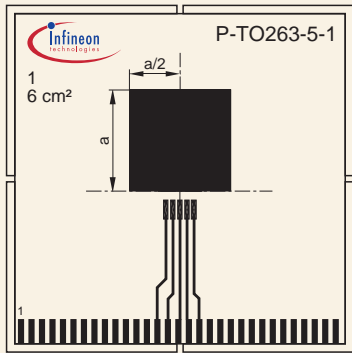

FR4; 80 x 80 x 1.5 mm; 35  $\mu$  Cu, 5  $\mu$  Sn  
A = 600 mm<sup>2</sup>; a = 24.49 mm

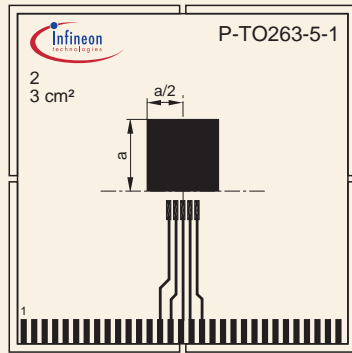

FR4; 80 x 80 x 1.5 mm; 35  $\mu$  Cu, 5  $\mu$  Sn  
A = 300 mm<sup>2</sup>; a = 17.32 mm

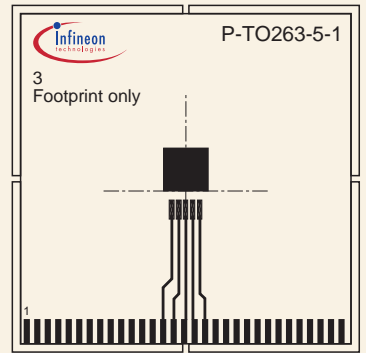

FR4; 80 x 80 x 1.5 mm; 35  $\mu$  Cu, 5  $\mu$  Sn  
Footprint only

## Finite Element Method

## FEM Simulation (chip area $\geq 2$ mm<sup>2</sup>; $P_v = 3$ W; zero airflow)

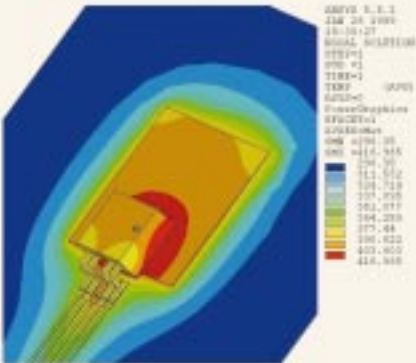

A = 600 mm<sup>2</sup>;  $T_a = 298$  K;  $T_{max} = 417$  K

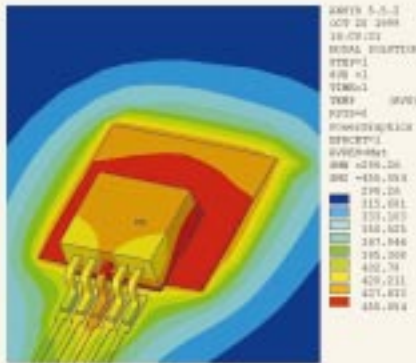

A = 300 mm<sup>2</sup>;  $T_a = 298$  K;  $T_{max} = 455$  K

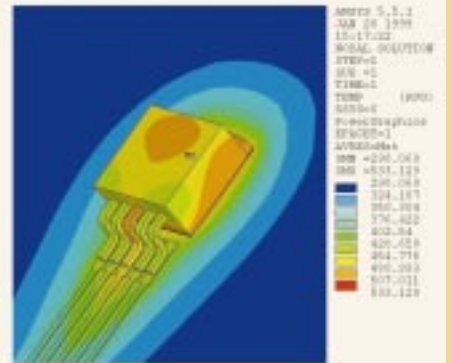

Footprint only;  $T_a = 298$  K;  $T_{max} = 533$  K

## Diagrams

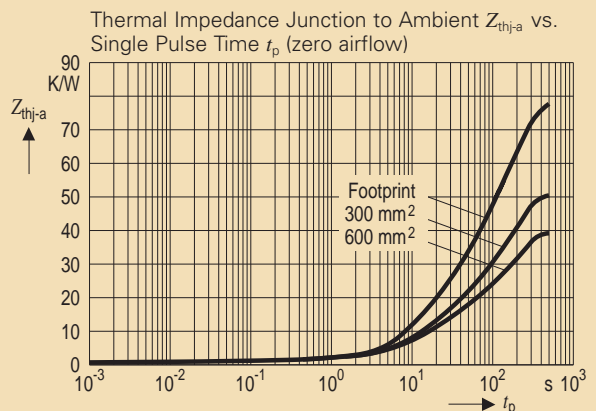
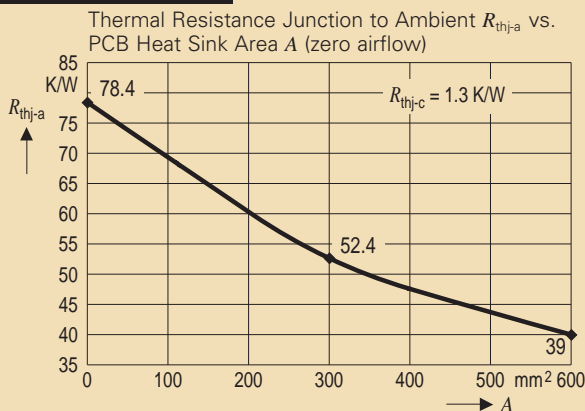

# Infineon Technologies AG's sales offices worldwide – partly represented by Siemens AG

**A**

Siemens AG Österreich  
Erdberger Lände 26  
**A-1031 Wien**  
☎ (+43) 1-17 07-3 56 11  
Fax (+43) 1-17 07-5 59 73

**AUS**

Siemens Ltd.  
885 Mountain Highway  
**Bayswater, Victoria 3153**  
☎ (+61) 3-97 21 21 11  
Fax (+61) 3-97 21 72 75

**B**

Siemens Electronic Components  
Benelux  
Charleroisesteeweg 116/  
Chaussée de Charleroi 116  
**B-1060 Brussel/Bruelles**  
☎ (+32) 2-5 36 69 05  
Fax (+32) 2-5 36 28 57  
Email: components@siemens.nl

**BR**

Siemens Ltda.  
Semicondutores  
Avenida Mutinga, 3800-Pirituba  
**05110-901 São Paulo-SP**  
☎ (+55) 11-39 08 25 64  
Fax (+55) 11-39 08 27 28

**CDN**

Infineon Technologies Corporation  
320 March Road, Suite 604  
**Canada, Ontario K2K 2E2**  
☎ (+1) 6 13-5 91 63 86  
Fax (+1) 6 13-5 91 63 89

**CH**

Siemens Schweiz AG  
Bauelemente  
Freilagerstrasse 40  
**CH-8047 Zürich**  
☎ (+41) 1-4 95 30 65  
Fax (+41) 1-4 95 50 50

**D**

Infineon Technologies AG  
Völklinger Str. 2  
**D-40219 Düsseldorf**  
☎ (+49) 2 11-3 99 29 30  
Fax (+49) 2 11-3 99 14 81

Infineon Technologies AG  
Werner-von-Siemens-Platz 1  
**D-30880 Laatzen (Hannover)**  
☎ (+49) 5 11-8 77 22 22  
Fax (+49) 5 11-8 77 15 20

Infineon Technologies AG  
Von-der-Tann-Straße 30  
**D-90439 Nürnberg**  
☎ (+49) 9 11-6 54 76 99  
Fax (+49) 9 11-6 54 76 24

Infineon Technologies AG  
Weissacher Straße 11  
**D-70499 Stuttgart**  
☎ (+49) 7 11-137 33 14  
Fax (+49) 7 11-137 24 48

**D**

Infineon Technologies AG  
Halbleiter Distribution  
Richard-Strauss-Straße 76  
**D-81679 München**  
☎ (+49) 89-92 21 40 86  
Fax (+49) 89-92 21 20 71

**DK**

Siemens A/S  
Borupvang 3  
**DK-2750 Ballerup**  
☎ (+45) 44 77-44 77  
Fax (+45) 44 77-40 17

**E**

Siemens S.A.  
Dpto. Componentes  
Ronda de Europa, 5  
**E-28760 Tres Cantos-Madrid**  
☎ (+34) 91-5 14 71 51  
Fax (+34) 91-5 14 70 13

**F**

Infineon Technologies France,  
39/47, Bd. Ornano  
**F-93527 Saint-Denis CEDEX 2**  
☎ (+33) 1-49 22 31 00  
Fax (+33) 1-49 22 28 01

**FIN**

Siemens Components  
Scandinavia  
P.O.Box 60  
**FIN-02601 Espoo (Helsinki)**  
T (+358) 10-5 11 51 51  
Fax (+358) 10-5 11 24 95  
Email:  
scs@components.siemens.se

**GB**

Infineon Technologies  
Siemens House  
Oldbury  
**GB-Bracknell, Berkshire**  
RG 12 8FZ  
☎ (+44) 13 44-39 66 18  
Fax (+44) 13 44-39 66 32

**H**

Simacomp Kft.  
Lajos u. 103  
**H-1036 Budapest**  
☎ (+36) 1-4 57 16 90  
Fax (+36) 1-4 57 16 92

**HK**

Infineon Technologies  
Hong Kong Ltd.  
Suite 302, Level 3,  
Festival Walk,  
80 Tat Chee Avenue,  
Yam Yat Tsuen,  
Kowloon Tong  
**Hong Kong**  
☎ (+8 52) 28 32 05 00  
Fax (+8 52) 28 27 97 62

**I**

Siemens S.p.A.  
Semiconductor Sales  
Via Piero e Alberto Pirelli, 10  
**I-20126 Milano**  
☎ (+39) 02-66 76 -1  
Fax (+39) 02-66 76 43 95

**IND**

Siemens Ltd.  
Components Division  
No. 84 Keonics Electronic City  
Hosur Road  
**Bangalore 561 229**  
☎ (+91) 80-8 52 11 22  
Fax (+91) 80-8 52 11 80

**Siemens Ltd.**

CMP Div, 5th Floor  
4A Ring Road, IP Estate  
**New Delhi 110 002**  
☎ (+91) 11-3 31 99 12  
Fax (+91) 11-3 31 96 04

**Siemens Ltd.**

CMP Div, 4th Floor  
130, Pandurang Budhkar Marg,  
Worli  
**Mumbai 400 018**  
☎ (+91) 22-4 96 21 99  
Fax (+91) 22-4 96 22 01

**IRL**

Siemens Ltd.  
Electronic Components Division  
8, Raglan Road  
**IRL-Dublin 4**  
☎ (+3 53) 1-2 16 23 42  
Fax (+3 53) 1-2 16 23 49

**IL**

Nisko Ltd.  
2A, Habarzel St.  
P.O. Box 58151  
**61580 Tel Aviv – Isreal**  
☎ (+9 72) 3-7 65 73 00  
Fax (+9 72) 3-7 65 73 33

**J**

Siemens Components K.K.  
Talanawa Park Tower 12F & 17F  
3-20-14, Higashi-Gotanda,  
Shinagawa-ku  
**Tokyo**  
☎ (+81) 3-54 49 64 11  
Fax (+81) 3-54 49 64 01

**MAL**

Infineon Technologies AG  
Sdn Bhd  
Bayan Lepas Free Industrial Zone 1  
**11900 Penang**  
☎ (+60) 4-6 44 99 75  
Fax (+60) 4-6 41 48 72

**N**

Siemens Components  
Scandinavia  
Østre Aker vei 24  
Postboks 10, Veitvet  
**N-0518 Oslo**  
T (+47) 22-63 30 00  
Fax (+47) 22-68 49 13  
Email:  
scs@components.siemens.se

**NL**

Siemens Electronic Components  
Benelux  
Postbus 16068  
**NL-2500 BB Den Haag**  
☎ (+31) 70-3 33 20 65  
Fax (+31) 70-3 33 28 15  
Email: components@siemens.nl

**NZ**

Siemens Auckland  
300 Great South Road  
Greenland  
**Auckland**  
☎ (+64) 9-5 20 30 33  
Fax (+64) 9-5 20 15 56

**P**

Siemens S.A.  
an Componentes Electronicos  
R. Irmaos Siemens, 1  
Alfragide  
**P-2720-093 Amadora**  
☎ (+351) 1-4 17 85 90  
Fax (+351) 1-4 17 80 83

**PK**

Siemens Pakistan Engineering  
Co.Ltd.  
PO Box 1129, Islamabad 44000  
23 West Jinnah Ave  
**Islamabad**  
☎ (+92) 51-21 22 00  
Fax (+92) 51-21 16 10

**PL**

Siemens SP. z.o.o.  
ul. Zupnicza 11  
**PL-03-821 Warszawa**  
☎ (+48) 22-8 70 91 50  
Fax (+48) 22-8 70 91 59

**ROK**

Siemens Ltd.  
Asia Tower, 10th Floor  
726 Yeoksam-dong, Kang-nam Ku  
CPO Box 3001  
**Seoul 135-080**  
☎ (+82) 2-5 27 77 00  
Fax (+82) 2-5 27 77 79

**RUS**

INTECH electronics  
ul. Smolnaya, 24/1203  
**RUS-125 445 Moskva**  
☎ (+7) 0 95-4 51 97 37  
Fax (+7) 0 95-4 51 86 08

**S**

Siemens Components Scandinavia  
Österögatan 1, Box 46  
**S-16493 Kista**  
T (+46) 8-7 03 35 00  
Fax (+46) 8-7 03 35 01  
Email:  
scs@components.siemens.se

**RC**

Infineon Technologies  
Asia Pacific Pte. Ltd.  
Taiwan Branch  
10F, No. 136 Nan King East Road  
**Section 23, Taipei**  
☎ (+8 86) 2-27 73 66 06  
Fax (+8 86) 2-27 71 20 76

**SGP**

Infineon Technologies Asia  
Pacific, Pte. Ltd.  
168 Kallang Way  
**Singapore 349 253**  
☎ (+65) 8 40 06 10  
Fax (+65) 7 42 62 39

**USA**

Infineon Technologies  
Corporation  
1730 North First Street  
**San Jose, CA 95112**  
☎ (+1) 4 08-5 01 60 00  
Fax (+1) 4 08-5 01 24 24

Siemens Components, Inc.  
Optoelectronics Division  
19000 Homestead Road  
**Cupertino, CA 95014**  
☎ (+1) 4 08-2 57 79 10  
Fax (+1) 4 08-7 25 34 39

Siemens Components, Inc.  
Special Products Division  
186 Wood Avenue South  
**Iselin, NJ 08830-2770**  
☎ (+1) 7 32-9 06 43 00  
Fax (+1) 7 32-6 32 28 30

**VRG**

Infineon Technologies  
Hong Kong Ltd.  
Beijing Office  
Room 2106, Building A  
Vantone New World Plaza  
No. 2 Fu Cheng Men Wai Da Jie  
**100037 Beijing**  
☎ (+86) 10-68 57 90 -06, -07  
Fax (+86) 10-68 57 90 08

Infineon Technologies  
Hong Kong Ltd.  
Chengdu Office  
Room 14J1, Jinyang Mansion  
58 Tidu Street  
**Chengdu, Sichuan Province 610 016**  
☎ (+86) 28-6 61 54 46 / 79 51  
Fax (+86) 28-6 61 01 59

Infineon Technologies  
Hong Kong Ltd.  
Shanghai Office  
Room 1101, Lucky Target Square  
No. 500 Chengdu Road North  
**Shanghai 200003**  
☎ (+86) 21-63 61 26 18/19  
Fax (+86) 21-63 61 11 67

Infineon Technologies  
Hong Kong Ltd.  
Shenzhen Office  
Room 1502, Block A  
Tian An International Building  
Renim South Road  
**Shenzhen 518 005**  
☎ (+86) 7 55-2 28 91 04  
Fax (+86) 7 55-2 28 02 17

**ZA**

Siemens Ltd.  
Components Division  
P.O.B. 3438  
**Halfway House 1685**  
☎ (+27) 11-6 52 -27 02  
Fax (+27) 11-6 52 20 42

# Total Quality Management

Qualität hat für uns eine umfassende Bedeutung. Wir wollen allen Ihren Ansprüchen in der bestmöglichen Weise gerecht werden. Es geht uns also nicht nur um die Produktqualität – unsere Anstrengungen gelten gleichermaßen der Lieferqualität und Logistik, dem Service und Support sowie allen sonstigen Beratungs- und Betreuungsleistungen.

Dazu gehört eine bestimmte Geisteshaltung unserer Mitarbeiter. Total Quality im Denken und Handeln gegenüber Kollegen, Lieferanten und Ihnen, unserem Kunden. Unsere Leitlinie ist, jede Aufgabe mit „Null Fehlern“ zu lösen – in offener Sichtweise auch über den eigenen Arbeitsplatz hinaus – und uns ständig zu verbessern. Unternehmensweit orientieren wir uns dabei auch an „top“ (Time Optimized Processes), um Ihnen durch größere Schnelligkeit den entscheidenden Wettbewerbsvorsprung zu verschaffen. Geben Sie uns die Chance, hohe Leistung durch umfassende Qualität zu beweisen.

Wir werden Sie überzeugen.

Quality takes on an all-encompassing significance at Semiconductor Group. For us it means living up to each and every one of your demands in the best possible way. So we are not only concerned with product quality. We direct our efforts equally at quality of supply and logistics, service and support, as well as all the other ways in which we advise and attend to you. Part of this is the very special attitude of our staff. Total Quality in thought and deed, towards co-workers, suppliers and you, our customer. Our guideline is “do everything with zero defects”, in an open manner that is demonstrated beyond your immediate workplace, and to constantly improve. Throughout the corporation we also think in terms of Time Optimized Processes (top), greater speed on our part to give you that decisive competitive edge. Give us the chance to prove the best of performance through the best of quality – you will be convinced.