



**USB08 Universal Serial Bus
Evaluation Board
Using the MC68HC908JB8**

Designer Reference Manual

USB08 Universal Serial Bus Evaluation Board Using the MC68HC908JB8

By: Dipl.-Ing. Oliver Thamm
MCT Elektronikladen GbR
Hohe Str. 9-13
04107 Leipzig
Germany



Telephone: +49 (0)341 2118354
Fax: +49 (0)341 2118355
Email: mct@elektronikladen.de
Web: <http://www.elektronikladen.de/mct>

Motorola and  are registered trademarks of Motorola, Inc.
DigitalDNA is a trademark of Motorola, Inc.

© Motorola, Inc., 2001

Motorola reserves the right to make changes without further notice to any products herein. Motorola makes no warranty, representation or guarantee regarding the suitability of its products for any particular purpose, nor does Motorola assume any liability arising out of the application or use of any product or circuit, and specifically disclaims any and all liability, including without limitation consequential or incidental damages. "Typical" parameters which may be provided in Motorola data sheets and/or specifications can and do vary in different applications and actual performance may vary over time. All operating parameters, including "Typicals" must be validated for each customer application by customer's technical experts. Motorola does not convey any license under its patent rights nor the rights of others. Motorola products are not designed, intended, or authorized for use as components in systems intended for surgical implant into the body, or other applications intended to support or sustain life, or for any other application in which the failure of the Motorola product could create a situation where personal injury or death may occur. Should Buyer purchase or use Motorola products for any such unintended or unauthorized application, Buyer shall indemnify and hold Motorola and its officers, employees, subsidiaries, affiliates, and distributors harmless against all claims, costs, damages, and expenses, and reasonable attorney fees arising out of, directly or indirectly, any claim of personal injury or death associated with such unintended or unauthorized use, even if such claim alleges that Motorola was negligent regarding the design or manufacture of the part. Motorola, Inc. is an Equal Opportunity/Affirmative Action Employer.

List of Sections

Section 1. USB08 Quick Start	17
Section 2. Hardware Description	27
Section 3. Software Module Descriptions	43
Section 4. Universal Serial Bus (USB) Interface	59
Appendix A. Supported Standard Device Requests	81
Appendix B. USB08 Descriptors	83
Appendix C. Source Code Files	89
Appendix D. Bill of Materials and Schematic	127
Appendix E. Universal USB Device Driver (USBIO)	131

List of Sections

Table of Contents

Section 1. USB08 Quick Start

1.1	Contents	17
1.2	Introduction	17
1.3	Required System Configuration	17
1.4	Connecting the Demo Board to the PC	18
1.5	Driver Installation	19
1.6	Starting the Windows Demo Application.	24

Section 2. Hardware Description

2.1	Contents	27
2.2	Introduction	27
2.3	Technical Data	28
2.3.1	MC68HC908JB8 Microcontroller	28
2.3.2	USB08 Evaluation Board	29
2.4	Circuit Description.	30
2.4.1	MCU Core Circuit and USB Interface.	31
2.4.2	Input/Output Functions	32
2.4.3	Monitor Mode Interface	33
2.4.4	User RS232 Port	35
2.4.5	Power Supply	36
2.5	Board Layout	36
2.6	Jumpers and Bridges	38

2.7	Connectors	40
2.7.1	Expansion Connector X1	40
2.7.2	Monitor Mode Connector X2	40
2.7.3	User RS232 Connector X3	41
2.8	Memory Map	41

Section 3. Software Module Descriptions

3.1	Contents	43
3.2	Introduction	43
3.3	General Structure of the M68HC08 Firmware	44
3.4	How to Build the Compiler Project	45
3.5	Main Module U08MAIN.C	48
3.6	Interrupt and Reset Vector Module VECJB8.C	49
3.7	C Startup Module CRTSJB8.S	50
3.8	Push Button Module U08KEY.C	50
3.9	LED Control with U08LED.H.	52
3.10	Software ADC Module U08ADC.C	52
3.11	RS232 Communication Module U08232.C	54
3.12	USB Communication Module U08USB.C	56
3.13	Compiler Specific Adjustments	57

Section 4. Universal Serial Bus (USB) Interface

4.1	Contents	59
4.2	Introduction	59
4.3	Characteristics of the USB08 Reference Design	60
4.4	USB Basics	62

4.5	USB Implementation in the Reference Design	65
4.5.1	Activation of the USB Module	65
4.5.2	Endpoint Configuration	65
4.5.3	USB Reset	67
4.6	Device Management with Endpoint 0	69
4.6.1	Enumeration	69
4.6.2	Assignment of the Device Address	69
4.6.3	Requesting Descriptors	72
4.6.4	Device Configuration	74
4.6.5	STALL Condition	74
4.7	Data Communication via Endpoints EP1 and EP2	75
4.7.1	Receiving Data	76
4.7.2	Transmission of Data	76
4.8	Host Interaction: Vendor ID and Product ID	78
4.9	Windows Device Driver	78

Appendix A. Supported Standard Device Requests

Supported Standard Device Requests	81
--	----

Appendix B. USB08 Descriptors

B.1	Contents	83
B.2	Introduction	83
B.3	Device Descriptor	84
B.4	Configuration Descriptor	84
B.5	Interface Descriptor	85
B.6	Endpoint 1 Descriptor	85
B.7	Endpoint 2 Descriptor	85
B.8	String Descriptors	86

Appendix C. Source Code Files

C.1	Contents	89
	HC908JB8.H	90
	U08USB.H	93
	U08232.H	96
	U08LED.H	96
	U08MAIN.C	97
	U08DESC.C	100
	U08USB.C	104
	U08232.C	113
	U08KEY.C	116
	U08ADC.C	117
	VECJB8.C	119
	CRTSJB8.S	120
	USB08.LKF	121
	BUILD.BAT	121
	USB08.MAP	122
	USB08.S19	125

Appendix D. Bill of Materials and Schematic

	Bill of Materials and Schematic	127
--	---------------------------------	-----

Appendix E. Universal USB Device Driver (USBIO)

E.1	Contents	132
E.2	Introduction	135
E.3	Overview	135
E.3.1	Platforms	136
E.3.2	Features	136
E.4	Architecture	138
E.4.1	USBIO Object Model	140
E.4.1.1	USBIO Device Objects	140
E.4.1.2	USBIO Pipe Objects	142
E.4.2	Establishing a Connection to the Device	144
E.4.3	Power Management	146

E.4.4	Device State Change Notifications	148
E.5	Programming Interface	149
E.5.1	Programming Interface Overview	149
E.5.2	Control Requests	150
E.5.3	Data Transfer Requests	182
E.5.3.1	Bulk and Interrupt Transfers	182
E.5.3.2	Isochronous Transfers	184
E.5.4	Input and Output Structures	185
E.5.5	Enumeration Types	214
E.5.6	Error Codes	218
E.6	USBIO Class Library	220
E.6.1	CUsblo Class	220
E.6.2	CUsbloPipe Class	221
E.6.3	CUsbloThread Class	222
E.6.4	CUsbloReaderClass	222
E.6.5	CUsbloWriter Class	222
E.6.6	CUsbloBufClass	223
E.6.7	CUsbloBufPool Class	223
E.7	USBIO Demo Application	223
E.7.1	Dialog Pages for Device Operations	224
E.7.1.1	Device	224
E.7.1.2	Descriptors	224
E.7.1.3	Configuration	225
E.7.1.4	Interface	225
E.7.1.5	Pipes	225
E.7.1.6	Class or Vendor Request	226
E.7.1.7	Feature	226
E.7.1.8	Other	226
E.7.1.9	Dialog Pages for Pipe Operations	227
E.7.1.10	Pipe	227
E.7.1.11	Buffers	227
E.7.1.12	Control	228
E.7.1.13	Read from Pipe to Output Window	228
E.7.1.14	Read from Pipe to File	228
E.7.1.15	Write from File to Pipe	229

Table of Contents

E.8	Installation Issues	229
E.8.1	Automated Installation: The USBIO Installation Wizard . . .	229
E.8.2	Manual Installation: The USBIO Setup Information File . . .	232
E.8.3	Uninstalling USBIO.	236
E.8.4	Building a Customized Driver Setup.	237
E.9	Registry Entries	239
E.10	Related Documents	241
E.11	Light Version Limitations.	241

List of Figures

Figure	Title	Page
1-1	Demo Board Connected to the USB Hub	18
1-2	Found New Hardware Screen	19
1-3	Found New Hardware Wizard Start Screen	20
1-4	Locate Driver Files Screen	21
1-5	Driver Files Search Results Screen	22
1-6	Found New Hardware Wizard Finish Screen	23
1-7	Windows Demo Application IO08USB	24
1-8	Driver Entry for USB08 in the Device Manager Window	25
2-1	USB08 Evaluation Board	30
2-2	PCB Component Side Layout Plan.	37
2-3	Detailed Layout Plan.	37
2-4	Solder Bridge Placement on Downside of the PCB	39
3-1	Structure and Dependencies of the Firmware Files	45
3-2	Measurement of Resistor Values Using a Digital Input	52
4-1	USB Address Register (UADDR)	65
4-2	USB Control Register 3 (UCR3)	66
4-3	USB Interrupt Register 0 (UIR0)	68
4-4	USB Control Register 0 (UCR0)	68
4-5	USB Interrupt Register 1 (UIR1)	69
4-6	USB Status Register 0 (USR0)	70
4-7	USB Control Register 0 (UCR0)	71
4-8	USB Address Register (UADDR)	72
4-9	USB Interrupt Register 1 (UIR1)	75
4-10	USB Status Register 1 (USR1)	76
4-11	USB Control Register 1 (UCR1)	77

List of Figures

Figure	Title	Page
D-1	USB08 Evaluation Board Schematic	129
E-1	USB Driver Stack	138
E-2	USBIO Device and Pipe Objects Example	143
E-3	Layout of an Isochronous Transfer Buffer	183
E-4	USBIO Class Library.	220

List of Tables

Table	Title	Page
2-1	Port A Monitor Mode Entry Levels	33
2-2	Monitor Mode Cable Pin Configuration	34
2-3	Jumper Configuration	38
2-4	Solder Bridges Configuration	39
2-5	MC68HC908JB8 Memory Map	41
3-1	Memory Utilization	47
4-1	Low-Speed USB Packet Types	62
4-2	MC68HC908JB8 Endpoint Configuration	66
D-1	Bill of Materials for USB08 V 1.01	128
E-1	I/O Operations Supported by the USBIO Device Driver	149
E-2	Error Codes Defined by the USBIO Device Driver	218
E-3	Registry Parameters Supported by the USBIO Driver	239

Section 1. USB08 Quick Start

1.1 Contents

1.2	Introduction	17
1.3	Required System Configuration	17
1.4	Connecting the Demo Board to the PC	18
1.5	Driver Installation	19
1.6	Starting the Windows Demo Application.	24

1.2 Introduction

This section describes the connection and startup of the USB08 (universal serial bus) evaluation board demo application. The main component of the USB08 is the Motorola MC68HC908JB8 8-bit microcontroller (MCU).

1.3 Required System Configuration

To connect the USB08, you will need a personal computer (PC) with one of the following Microsoft® operating systems:

- Windows® 98
- Windows ME
- Windows 2000 Professional

NOTE: *Ensure that the PC has the necessary hardware (universal serial bus (USB) host controller and USB root hub) and that the necessary system drivers are installed.*

Microsoft and Windows are registered trademarks of Microsoft Corporation in the United States and/or other countries.

1.4 Connecting the Demo Board to the PC

Since low-speed USB devices should be equipped with a captive connection, the USB cable is fixed on the USB08 board (downstream direction). In the upstream direction (PC/host side), the USB connections are always type A. Therefore, the cable of the USB08 demo board has a type A plug.

The connection of the demo board is made directly to the USB socket of the PC or, as shown in the [Figure 1-1](#), to a USB hub.



Figure 1-1. Demo Board Connected to the USB Hub

The board supply current can be delivered by the USB connection. Therefore, the jumper JP2, which is directly beside the USB cable, has to be in the position **Bus Powered**. The jumper JP1-A (jumper block, highest position) must be opened, which corresponds to the default shipping configuration.

1.5 Driver Installation

For this example, the installation of the driver software is described using the Windows 2000 operating system. The installation using Windows 98 (second edition) looks quite similar.

After the electrical connection of the demo board, the Windows operating system recognizes the presence of a new hardware component and shows the message ***Found New Hardware***.

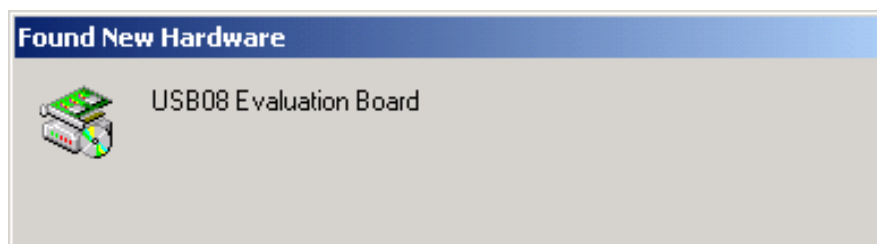

Figure 1-2. Found New Hardware Screen

The hardware assistant, **Figure 1-3**, now tries to find the suitable driver information for the USB08 evaluation board. Click the **Next** button.

NOTE: *The installation using the Windows 2000 operating system requires administrator rights.*

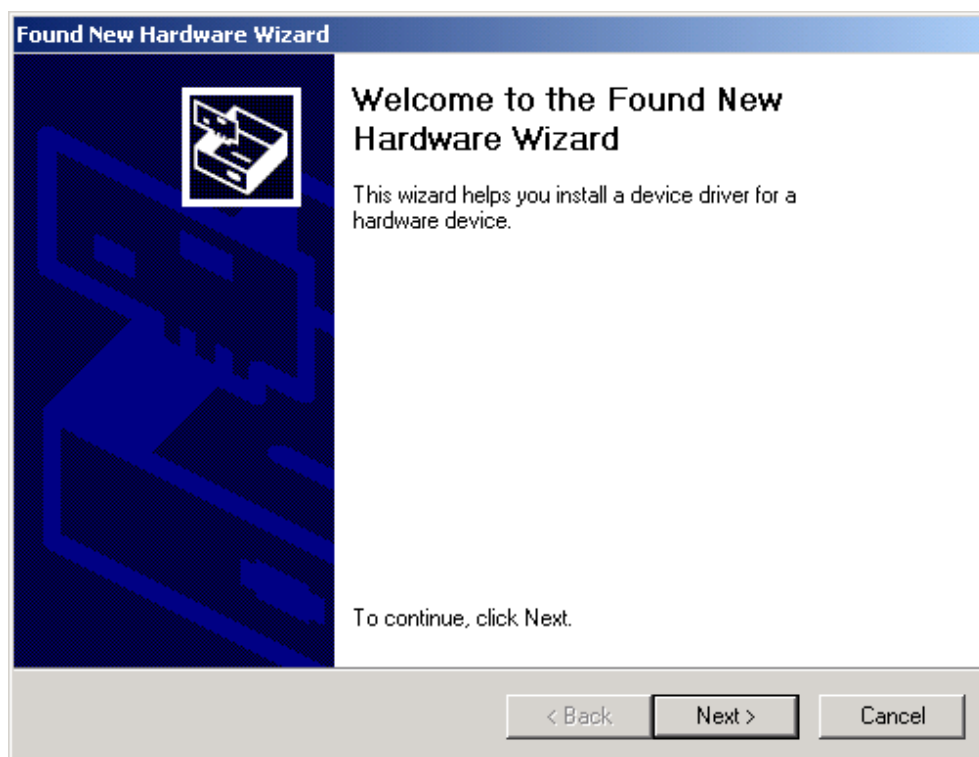

Figure 1-3. Found New Hardware Wizard Start Screen

Insert the USB08 product CD into the CD-ROM drive and mark the appropriate check box **CD-ROM drives** as shown in **Figure 1-4**. Click the **Next** button.

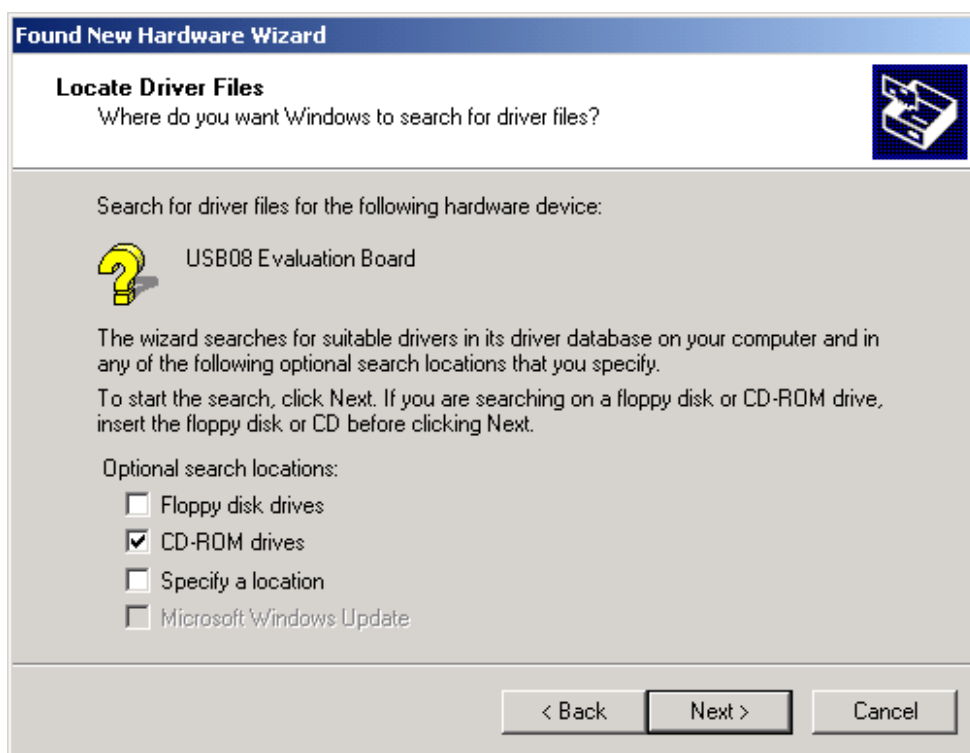

Figure 1-4. Locate Driver Files Screen

As shown in **Figure 1-5**, the hardware assistant will find the driver information file `usbio_el.inf` in the root directory of the CD ROM. Confirm this selection by clicking **Next**.

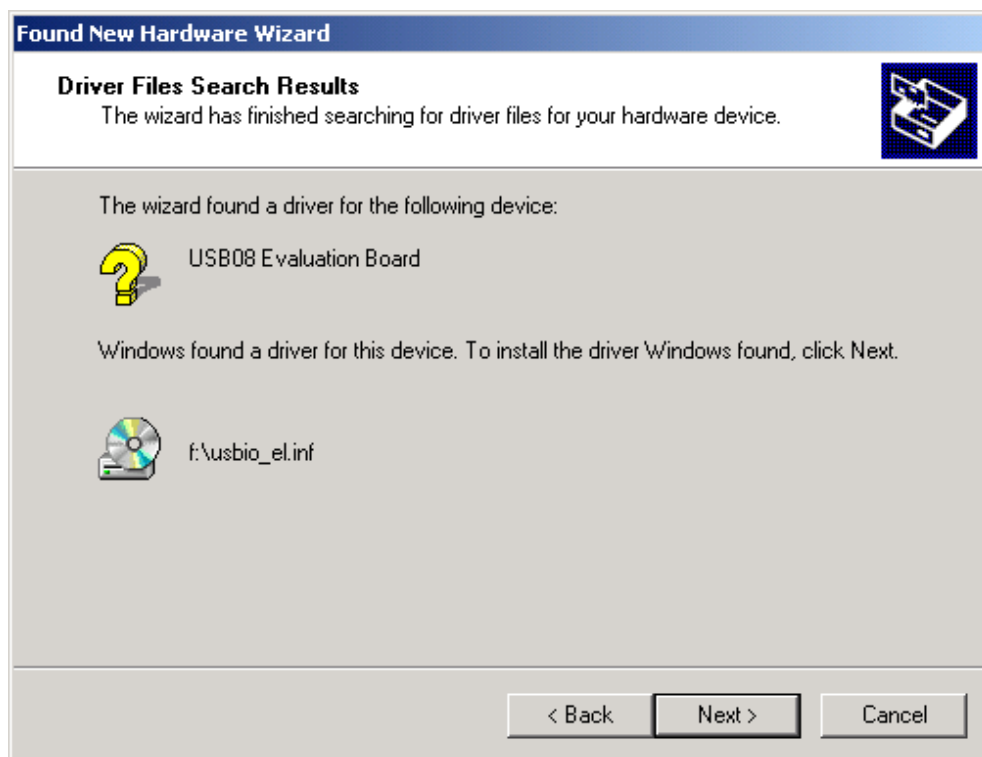

Figure 1-5. Driver Files Search Results Screen

The Windows operating system now copies the INF file and the driver file `usbio_el.sys` to the appropriate Windows directories. After clicking **Finish** (Figure 1-6), the driver installation will be completed and the USB device will be ready for use.

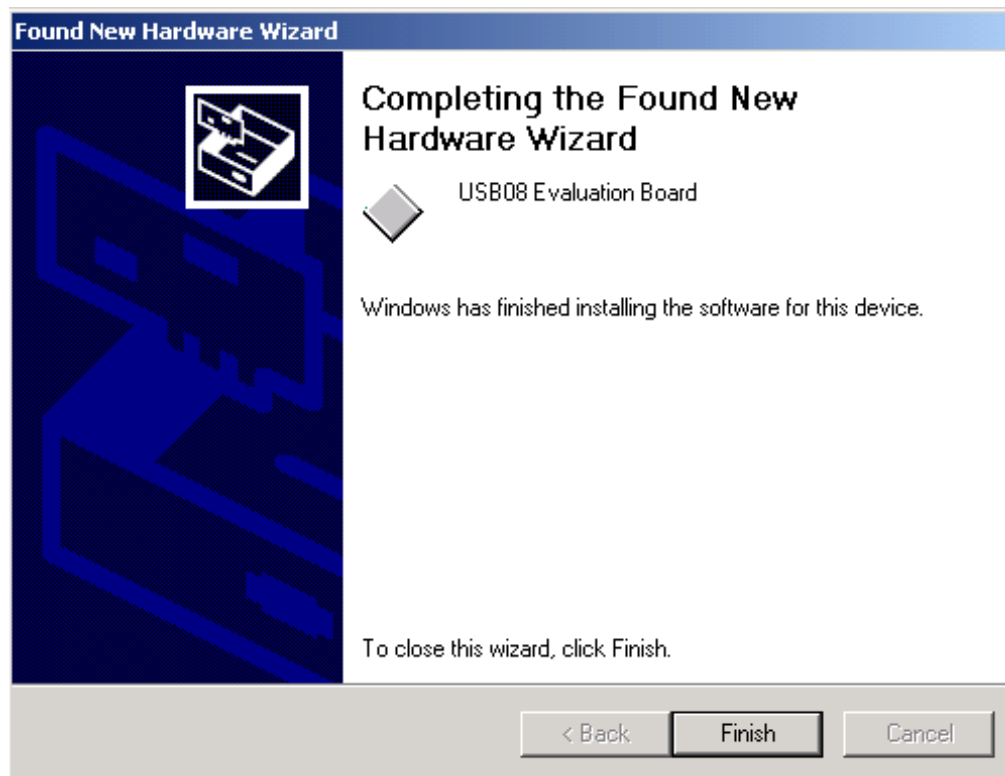

Figure 1-6. Found New Hardware Wizard Finish Screen

NOTE: *The installation does not require a restart of the computer, since this is a true Plug & Play installation.*

1.6 Starting the Windows Demo Application

The windows demo application:

- Shows the measured values and push button information coming from the demo board
- Allows the controlling of the demo board light-emitting diodes (LED)

The demo application is located in the root directory of the USB08 product CD. The file name of the demo application is IO08USB.EXE. This program can be started directly from the CD.

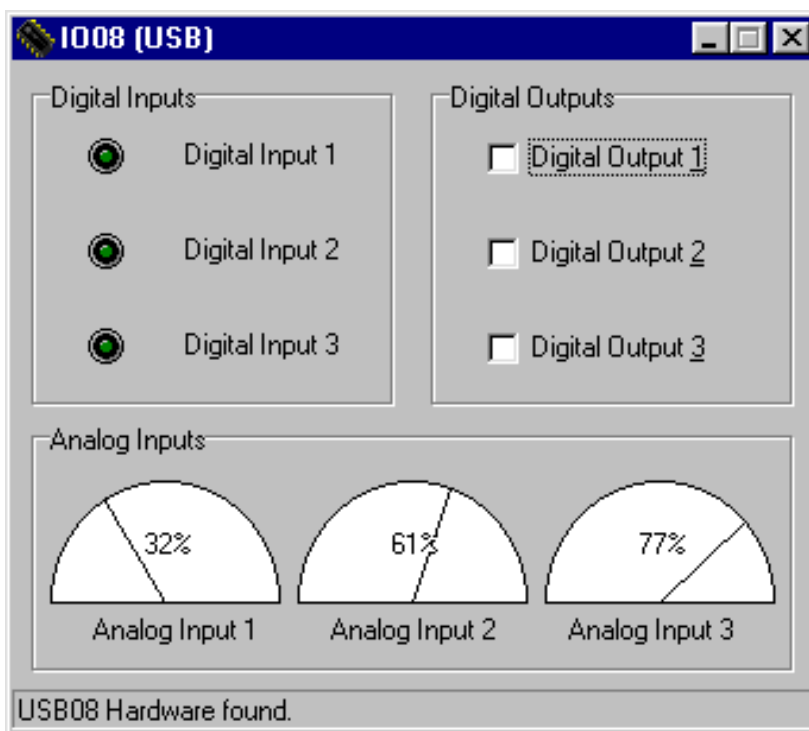

Figure 1-7. Windows Demo Application IO08USB

As shown in [Figure 1-7](#), the bottom line of the application window shows the status of the connection established to the USB08 demo board. The LED symbols on the left upper side of the application window can be switched on or off by pressing the keys of the USB08 demo board.

By setting the check boxes on the upper right side it is possible to switch on or off the LEDs of the demo board. The needle pointer instruments on the lower side of the application window indicate the measured values of the three variable resistors:

- Input 1 represents the photo sensor.
- Input 2 shows the thermistor value.
- Input 3 can be varied using the turnable regulator.

The USB08 evaluation board can be disconnected from the USB port and reconnected at any time, because the drivers are automatically activated or deactivated by the Windows operating system. The activation/deactivation of the drivers can be watched in the operating system's device manager window (start button/settings/control panel/system/device manager). The catalog entry **USBIO controlled devices** and the device entry **USB08 Evaluation Board** are visible only if the hardware is present. See [Figure 1-8](#).

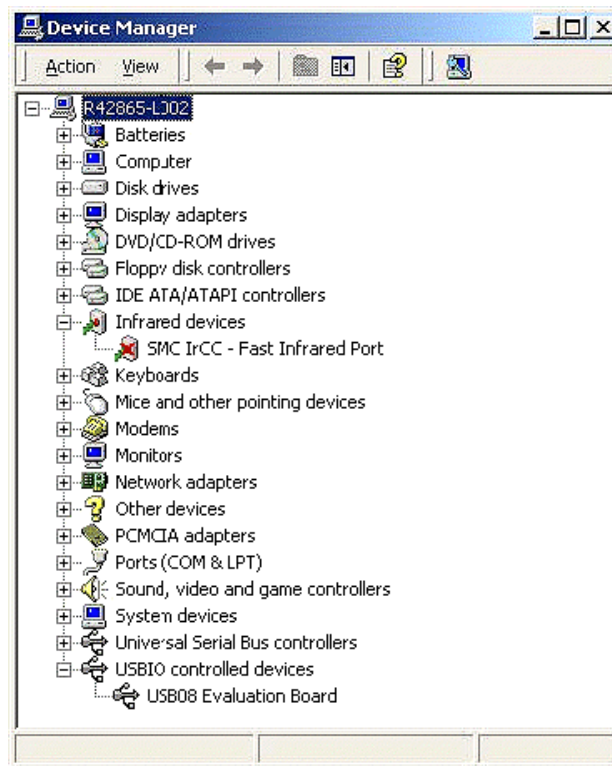

Figure 1-8. Driver Entry for USB08 in the Device Manager Window

The Windows demo application, IO08USB.EXE, must be re-started in the case of a hardware connection interrupt. This is because an automatic resynchronization (though it would be possible) was not implemented here. The demo application is arranged as simply and as understandable as possible.

Section 2. Hardware Description

2.1 Contents

2.2	Introduction	27
2.3	Technical Data	28
2.3.1	MC68HC908JB8 Microcontroller	28
2.3.2	USB08 Evaluation Board	29
2.4	Circuit Description	30
2.4.1	MCU Core Circuit and USB Interface	31
2.4.2	Input/Output Functions	32
2.4.3	Monitor Mode Interface	33
2.4.4	User RS232 Port	35
2.4.5	Power Supply	36
2.5	Board Layout	36
2.6	Jumpers and Bridges	38
2.7	Connectors	40
2.7.1	Expansion Connector X1	40
2.7.2	Monitor Mode Connector X2	40
2.7.3	User RS232 Connector X3	41
2.8	Memory Map	41

2.2 Introduction

The USB08 evaluation board is the hardware platform for the universal serial bus (USB) reference design. The board serves the provided demo application, which is contained in the integrated FLASH memory of the M68HC08 microcontroller (MCU).

Beyond that, the USB08 enables the implementation and testing of its own M68HC08 software for evaluation purposes. For that purpose, the board contains a monitor mode interface for reprogramming and debugging. The monitor mode interface of the USB08 is compatible with Motorola development tools such as the M68ICS08JB8 and other third-party tools.

2.3 Technical Data

This subsection provides technical data for both the MC68HC908JB8 and the USB08 evaluation board.

2.3.1 MC68HC908JB8 Microcontroller

The main component of the USB08 evaluation board is the MC68HC908JB8, a Motorola 8-bit MCU. Features of the MC68HC908JB8 include:

- Efficient M68HC08 MCU core
- 8 Kbytes of on-chip FLASH memory with security feature
- 256 bytes of random-access memory (RAM)
- 3-MHz bus clock (6-MHz quartz crystal)
- 2 × 16-bit timer with:
 - Input capture
 - Output compare
 - Pulse-width modulator (PWM)
- Low-speed USB 1.1 interface module
- Integrated 3-V voltage regulator
- Computer operating properly (COP) watchdog timer
- Low-voltage interrupt (LVI) reset controller
- Inputs for RESET and $\overline{\text{IRQ}}$ pins
- Up to 21 input/output (I/O) lines

2.3.2 USB08 Evaluation Board

Features of the USB08 evaluation board include:

- M68HC908JB8 MCU packaged in a 28-pin small-outline integrated circuit package (SOIC)
- Three light-emitting diodes (LED)
- Three input keys
- Three analog sensors:
 - Light
 - Temperature
 - Angle of rotation
- Current supplied alternatively via USB connection or on-board voltage regulator
- Monitor mode interface for in-system programming and debugging
- Additional RS232 interface for connection to PC or serial liquid crystal display (LCD)
- Push buttons for reset and IRQ
- Jumper for power-on reset (POR)
- All MCU pins are accessible via a 26-pin universal expansion connector
- Small user breadboard area reserved for customer circuit extensions

The USB08 evaluation board is shown in [Figure 2-1](#).

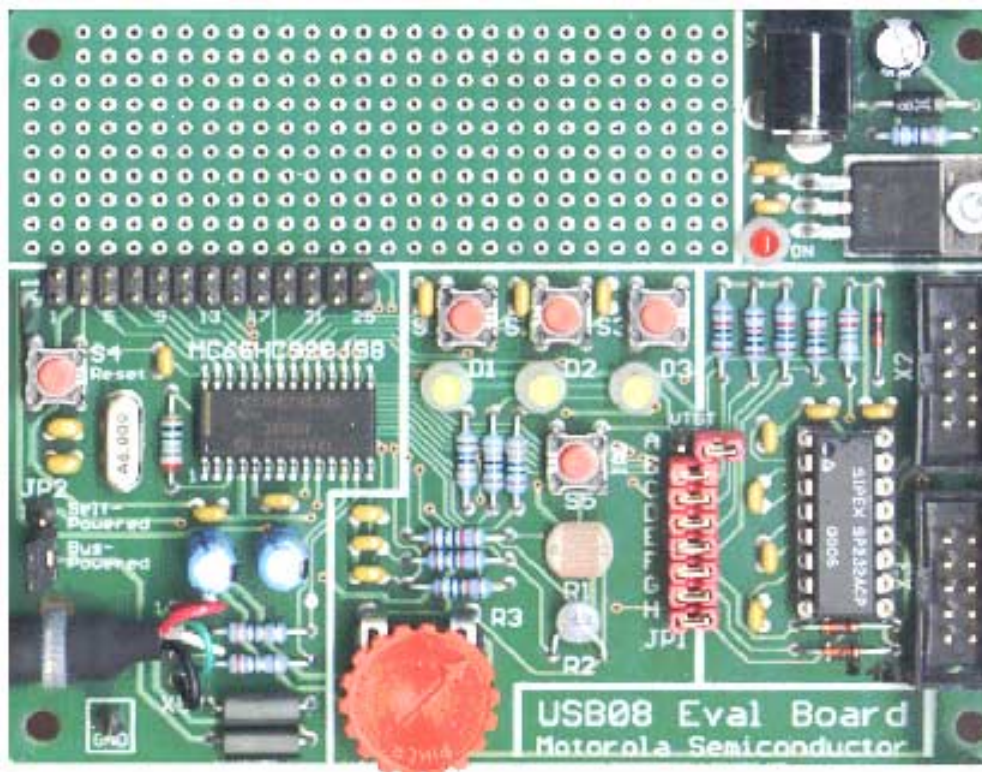

Figure 2-1. USB08 Evaluation Board

2.4 Circuit Description

A schematic of the USB08 demo board is provided in [Appendix D. Bill of Materials and Schematic](#). The MC68HC908JB8 MCU needs few external elements. A wide range of peripheral functions including the USB module and an 8-Kbyte FLASH memory are integrated on-chip. The MC68HC908JB8 is offered in several packages. For the USB08 reference design, the 28-pin SOIC version was chosen instead of the 20-pin dual in-line package (DIP) because the SOIC package has some additional I/O pins.

2.4.1 MCU Core Circuit and USB Interface

The operating voltage, V_{DD} , is supported by the capacitors C6 and C3 close to the MCU. Out of this primary operating voltage of approximately 5 V, the MCU produces an internal operating voltage, V_{REG} , of 3.3 V, using an integrated voltage regulator. This voltage is supported by two capacitors, C4 and C5, and continues in the circuit as V_{CC} .

In particular, the internal voltage V_{CC}/V_{REG} is used as the USB interface driver voltage supply. V_{CC}/V_{REG} is accessible over the expansion plug connector X1. However, it must be noted that V_{CC}/V_{REG} can be additionally loaded only with a few milliamps.

For clock generation, the external elements Q1, C1, C2, and R18 are used. These elements form a Pierce oscillator together with the active elements integrated in the MCU. This oscillator produces a clock frequency of 6 MHz. The internal bus clock of the MCU (3 MHz) as well as the USB clock (1.5 MHz) are derived from the main clock frequency.

The USB data lines are connected to the MCU pins PTE3 (USB D+) and PTE4 (USB D-). So that the USB hub will be able to classify this equipment as a low-speed USB device, a pullup resistance of 1.5 k Ω (R7) to the data line D- is required.

On the demo board, R7 is not installed. This is because the MC67HC908JB8 has an additional internal pullup at PTE4 which can be activated and de-activated by software.

To optimize the connection adjustment, the serial resistors in the data lines R16 and R17 and inductances (ferrite beads) in the current supply path L1 and L2 are used. However, these measures are optional.

The reset system of the M68HC08 shows clear differences from other Motorola MCUs (M68HC11 and M68HC12). For example, the capacitor C19 at the reset pin of this circuit could never be used in an M68HC11 system. This is because the MC68HC908JB8 has an integrated low-voltage inhibit (LVI) circuit. Therefore, no external reset controller is required.

2.4.2 Input/Output Functions

For demonstration purposes, the board has:

- Three push buttons
- Three light-emitting diodes (LED)
- Sensor resistors

The push buttons are connected to the three port pins PTA4, PTA5, and PTA6. By pushing the buttons, a low level is produced on the appropriate input. Since the port pins have internal pullup resistors, no external resistors are required. The buttons are bridged with capacitors, to support correct reading of the inputs by the software and to avoid noise. The occurrence of the high-low edge at the respective pin of port A is an input event which results in the generation of a keyboard interrupt by the MC68HC08JB8. This interrupt is then used by the program (see [Section 3. Software Module Descriptions](#)).

For optical signalling, three LEDs are attached to port D. These port pins have a high drive capability of up to 25 mA. Therefore, it is not necessary to use a driver. On the board, PTD0, PTD1, and PTD2 are used for LED control. All outputs generated by the port D pins have an open-drain characteristic and are 5-V tolerant.

The remaining port D pins (PTD3–PTD6) are used for controlling the software analog-to-digital converter (ADC). The ADC implementation is described in detail in [Section 3. Software Module Descriptions](#) as well as in the application note entitled *Simple A/D for MCUs without Built-in A/D Converters*, Motorola document order number AN477/D. This application note can be found on the World Wide Web at:

<http://www.motorola.com/semiconductors/>

The software ADC senses the resistance of:

- R1 (photo resistor)
- R2 (thermistor)
- R3 (potentiometer)

To determine capacitor load times, the MCU pins PTE0–PTE2 serve as trigger inputs for the software ADC.

The I/O pins of the MCU are accessible on the expansion connector X1. User specific peripheral circuits can be attached to X1.

NOTE: *It may be that not all functions of the demo board may be used with user-specific peripheral circuits attached to X1.*

2.4.3 Monitor Mode Interface

For FLASH programming and software debugging, the MC68HC908JB8 uses a special operating mode, monitor mode. The difference between monitor mode and normal user mode is that firmware out of the read-only memory (ROM) is executed instead of the user program. First, this firmware examines a set of I/O pins and specifies the concrete operating parameters. Finally, this firmware establishes an asynchronous serial interface function on the port pin PTA0. This interface works bidirectionally (half duplex) and corresponds to the usual RS232 conventions. The baud rate equals 9600 baud. An additional requirement, besides the quartz clock (6 MHz), is the allocation of certain logic levels to some port pins as listed in [Table 2-1](#).

Table 2-1. Port A Monitor Mode Entry Levels

Port Pin	Level
PTA0	High
PTA1	High
PTA2	Low
PTA3	High

The monitor mode circuitry on the evaluation board produces the levels shown in [Table 2-1](#) using four pullup or pulldown resistors. These resistors are connected to the MCU using the jumpers JP1-C–JP1-F. After removing these jumpers, a previously loaded user program can access the four port A pins without restrictions.

Apart from the above requirements, to enter monitor mode it is necessary to apply a voltage of approximately 7–10 V to the $\overline{\text{IRQ}}$ pin of the MCU. This voltage is generated by the RS232 transceiver's (IC2) charge pump and limited to 8.2 V using the breakdown diode D7. JP1-A

is the first jumper of the jumper block JP1, and it must be set in order to apply high voltage to \overline{IRQ} .

If the monitor mode interface is not needed or if it disturbs the investigation of certain circuit configurations, it can be uncoupled completely from the MCU core. For this purpose:

- All jumpers of jumper block JP1 have to be removed.
- RS232 receiver IC2 has to be removed from the socket.

Using the X2 plug connector, the monitor mode interface is connected to the PC. The monitor mode cable consists of:

- A flat cable with a Berg connector (2×5 pin, crimping connection) on the device side
- A sub-D9 connector (crimping connection) on the PC side

A one-to-one connection is implemented by this cable configuration, as shown in [Table 2-2](#).

Table 2-2. Monitor Mode Cable Pin Configuration

X2 Pin	USB08 Monitor	PC RS232	Sub-D 9 Pin
3	T1OUT	RxD	2
5	R1IN	TxD	3
9	GND	GND	5

The MC68HC908JB8 logic levels are based on the operating voltage V_{CC} (3.3 V); however, the transceiver IC2 works with V_{DD} (5 V). The adjustment of the logic levels according to specification is not difficult (refer to the individual integrated circuit data sheets). The Schottky diode, D6, enables the push/pull exit R1OUT to be wired-OR capable and prevents a feeding of levels beyond the tolerance limit of the input PTA0.

2.4.4 User RS232 Port

The monitor mode interface uses only one sending/receiving channel of the RS232 transceiver IC2. The remaining channel is used for an additional user RS232 port.

In contrast to the RS232 channel for the monitor mode interface, the user RS232 port incorporates separate sending and receiving lines. The PTA7 pin of the MCU is used for receiving and the PTC0 pin is used for sending.

NOTE: *The MC68HC908JB8 does not have a serial communications interface (SCI) hardware module for asynchronous serial communication. Therefore, the necessary timing has to be generated by software.*

If PTA7 and/or PTC0 are to be used, the diode D5 serves for the adjustment of the logic levels between 5 V and 3 V. Otherwise, the RS232 transceiver can be uncoupled from the MCU by removing the jumpers JP1-G and JP1-H.

X3 is the user RS232 port plug connector. If this interface is attached to a PC, a line connection similar to the monitor mode interface is necessary. In this case, the bridges BR1 and BR2 on the downside of the printed circuit board (PCB) (see [Figure 2-3](#)) have to be connected in positions 1 and 2. For this configuration, the PC works as a host and the USB08 board represents the device side.

The reverse case happens, if a serial liquid crystal display (LCD) is to be operated at the user RS232 port. In this configuration, the USB08 board is the host and the LCD module represents the device side. The necessary RxD/TxD crossing is done by configuration of the bridges BR1 and BR2 in positions 2 and 3. At the same time, the serial LCD can be supplied with operating voltage by closing the bridge BR3.

NOTE: *This specification deviates from standard RS232 mapping.*

Serial alphanumeric LCDs are offered by several vendors. In the test configuration, the LCDs used are from the Canadian manufacturer Matrix Orbital (<http://www.matrixorbital.com>).

2.4.5 Power Supply

Power can be supplied to the USB08 board by using the USB or via the voltage regulator IC3. The change between these options is done by replacing the jumper JP2. If the jumper is placed in position 2–3 (**Bus Powered**), the operating power is supplied by V_{BUS} and V_{GND} from the USB.

If a dc voltage between 8 V and 20 V is fed into the power plug X4 in jumper position 1–2 (**Self Powered**), the voltage regulator IC3 supplies 5 V in the case. The solder bridge BR4 on the downside of the PCB (see [Figure 2-3](#)) has to be in position 1–2. Alternatively, if the bridge BR4 is in position 2–3, a stabilized 5-V power supply can be used to feed V_{DD} directly.

The voltage regulator IC3 is specified with 1 ampere. Although no special cooling measures are intended, IC3 is more than sufficiently dimensioned. The input current of the board, even in the worst case, is clearly smaller than 100 mA.

A USB hub supplies at least 100 mA. Therefore, the power supply of the board via the USB is possible without any problem. The USB08 board power input specification should be registered in the device descriptor of the USB device (see [Section 4. Universal Serial Bus \(USB\) Interface](#)).

2.5 Board Layout

[Figure 2-2](#) and [Figure 2-3](#) show the components and parts layout, as well as a general picture of the board.

On the component side, [Figure 2-2](#):

- The jumpers, plugs, push buttons, and LEDs are marked.
- The USB cable is fixed on the board with a cable strap, and the four line ends are soldered directly to the X5 connection points (without patch cord). This kind of connection is usual for low-speed USB devices.

A detailed layout plan of the USB08 board with the names of all components is shown in [Figure 2-3](#).

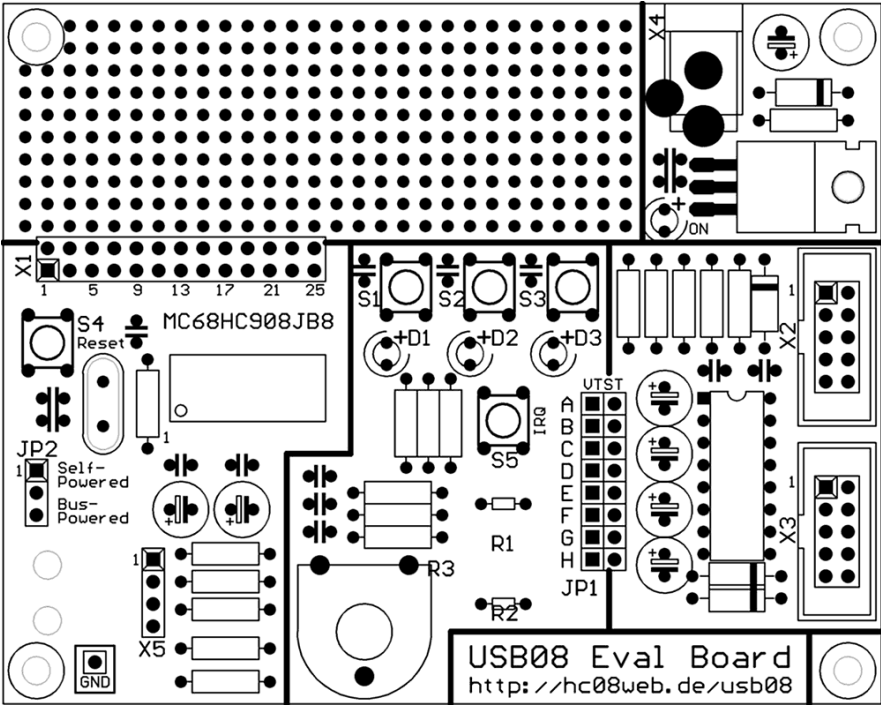

Figure 2-2. PCB Component Side Layout Plan

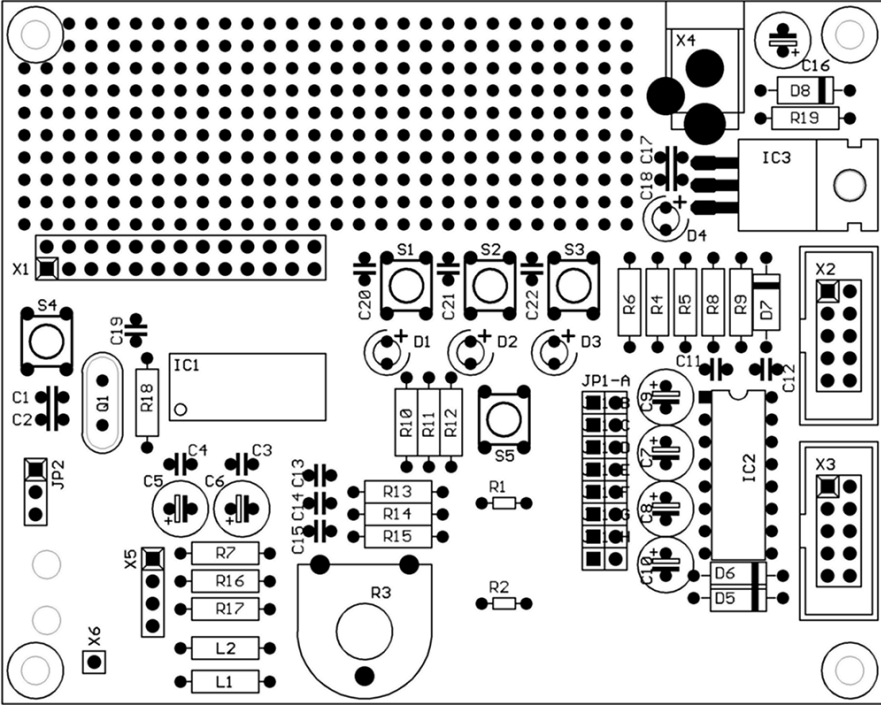

Figure 2-3. Detailed Layout Plan

2.6 Jumpers and Bridges

The jumper configuration is shown in [Table 2-3](#).

Table 2-3. Jumper Configuration

Jumper	Position ^(a)	Function
JP1-A	Open*	Normal user mode
	Closed	High voltage on \overline{IRQ} to enter monitor mode
JP1-B	Open	RS232 is disconnected from the power supply.
	Closed*	RS232 is connected to the power supply.
JP1-C	Open	PTA0 can be used without restriction.
	Closed*	PTA0 is used for monitor mode communication.
JP1-D	Open	PTA1 can be used without restriction.
	Closed*	PTA1 is used for monitor mode configuration.
JP1-E	Open	PTA2 can be used without restriction.
	Closed*	PTA2 is used for monitor mode configuration.
JP1-F	Open	PTA3 can be used without restriction.
	Closed*	PTA3 is used for monitor mode configuration.
JP1-G	Open	PTA7 can be used without restriction.
	Closed*	PTA7 serves as receiving line for the user RS232.
JP1-H	Open	PTC0 can be used without restriction.
	Closed*	PTC0 serves as transmission line for the user RS232.
JP2	1-2	Self-powered: power supply via voltage regulator
	2-3*	Bus-powered: power supply via USB

a. * = delivery status

Placement of the solder bridges on the downside of the PCB is shown in [Figure 2-4](#). [Table 2-4](#) shows the solder bridges configuration.

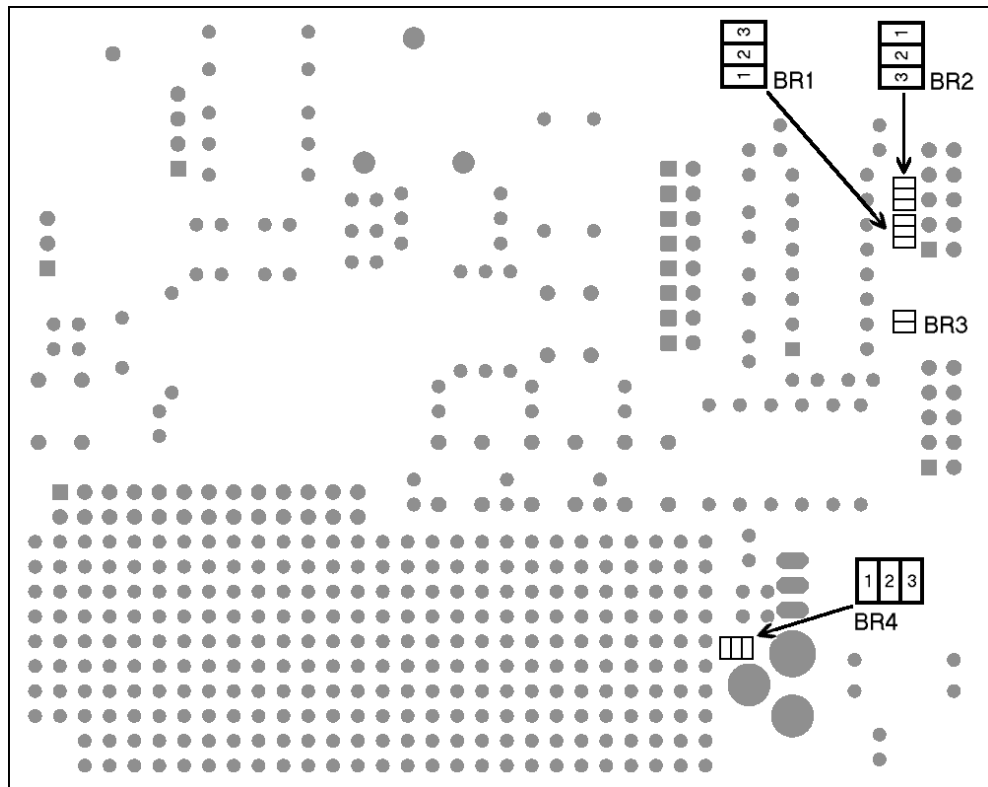

Figure 2-4. Solder Bridge Placement on Downside of the PCB

Table 2-4. Solder Bridges Configuration

Solder Bridge	Position ⁽¹⁾	Function
BR1 and BR2	1-2*	User RS232 configured in external device mode (PC)
	2-3	User RS232 configured in host mode (LCD connection)
BR3	Open*	V _{CC} is not present at user RS232 port (standard).
	Closed	V _{CC} is present at pin 9 of the user RS232.
BR4	1-2*	Power supply via voltage regulator, 8–20 V needed at X4
	2-3	Power supply directly from X4, must be stabilized at 5 V

1. * = delivery status

2.7 Connectors

The connectors are described here.

2.7.1 Expansion Connector X1

V_{DD}	1	2	V_{CC}
\overline{RTS}	3	4	PTA0
PTD0	5	6	PTA1
PTD1	7	8	PTA2
PTD2	9	10	PTA3
PTD3	11	12	PTA4
PTD4	13	14	PTA5
PTD5	15	16	PTA6
PTD6	17	18	PTA7
PTE3	19	20	PTE0
PTE4	21	22	PTE1
PTC0	23	24	PTE2
GND	25	26	GND

X1

2.7.2 Monitor Mode Connector X2

N.C.	1	2	N.C.
PC_RxD	3	4	N.C.
PC_TxD	5	6	N.C.
N.C.	7	8	N.C.
GND	9	10	N.C.

X2

2.7.3 User RS232 Connector X3

N.C.	1	2	N.C.
Rx (Tx)	3	4	N.C.
Tx (Rx)	5	6	N.C.
N.C.	7	8	V _{DD}
GND	9	10	N.C.

X3

2.8 Memory Map

Table 2-5. MC68HC908JB8 Memory Map

From	To	Size	Content
0x0000	0x003F	64 bytes	Control registers
0x0040	0x013F	256 bytes	RAM
0x0140	0xDBFF	—	Reserved
0xDC00	0xFBFF	8 Kbytes	FLASH memory
0xFC00	0xFFDF	—	Reserved
0xFFE0	0xFFFF	32 bytes	Interrupt vector table (FLASH)

For a detailed description of the MC68HC908JB8 memory map, in particular the addresses of control registers and interrupt vectors, refer to the *MC68HC908JB8 Technical Data*, Motorola document order number MC68HC908JB8/D.

Section 3. Software Module Descriptions

3.1 Contents

3.2	Introduction	43
3.3	General Structure of the M68HC08 Firmware	44
3.4	How to Build the Compiler Project	45
3.5	Main Module U08MAIN.C	48
3.6	Interrupt and Reset Vector Module VECJB8.C	49
3.7	C Startup Module CRTSJB8.S	50
3.8	Push Button Module U08KEY.C	50
3.9	LED Control with U08LED.H.	52
3.10	Software ADC Module U08ADC.C	52
3.11	RS232 Communication Module U08232.C	54
3.12	USB Communication Module U08USB.C	56
3.13	Compiler Specific Adjustments	57

3.2 Introduction

This section describes the structure and interaction of the software modules. These software modules, running on the Motorola microcontroller MC68HC908JB8, form the firmware of the USB08 reference design.

3.3 General Structure of the M68HC08 Firmware

The firmware of the M68HC08 consists of several source code modules which are embedded into a common compiler project. The main() function is contained in the module **U08MAIN.C**. It controls the program sequence via an endless loop (as usual in embedded software). The module **U08KEY.C** settles the scanning of the input keys. Control of the light-emitting diodes (LED) on the board is done using simple C macros; no special C module is required for this purpose. The module **U08ADC.C** is responsible for reading of the resistive sensors.

These modules are supported by the file **VECJB8.C**, which contains the interrupt and reset vectors. The four C source code modules are merged into a common compiler project. In addition, the assembler module **CRTSJB8.S** which contains the C startup code is required.

The control of keys, LEDs, and analog-to-digital (A/D) transmitters are support functions to the demonstration project because the main attention is paid to the communication interface. The communication functions are implemented directly by means of “#include” instructions in the main module **U08MAIN.C**.

Two ways of communication are implemented in the demonstration: RS232 or USB. The selection takes place by defining USE_USB_PIPE in the head of the main module. If this macro is defined, **U08USB.C** automatically becomes a part of the main module; otherwise, the RS232 communication module **U08232.C** is merged.

If the USB implementation in the file **U08USB.C** is used, the file **U08DESC.C** is also translated at the same time. It contains the static data for all necessary USB descriptors.

For each of the C files **U08KEY.C**, **U08ADC.C**, **U08USB.C**, and **U08232.C** there is a corresponding header file (* H) with the same base name. The functions for controlling the LEDs on the board are contained as macros in the file **U08LED.H**. In several cases, the header MC68HC08JB8.H contains the register and bit mask definitions required by the MC68HC908JB8 microcontroller (MCU).

Figure 3-1 shows the structure and interaction of the modules and files that could be included by means of “#include” instructions. To accomplish a complete compiler build, the grey modules have to be included in a compiler project.

3.4 How to Build the Compiler Project

The Cosmic C Compiler can to arrange a project within the compiler IDE. The compiler project owns:

- A list of source modules to be compiled
- Translation options
- Additional tools such as S-record generation

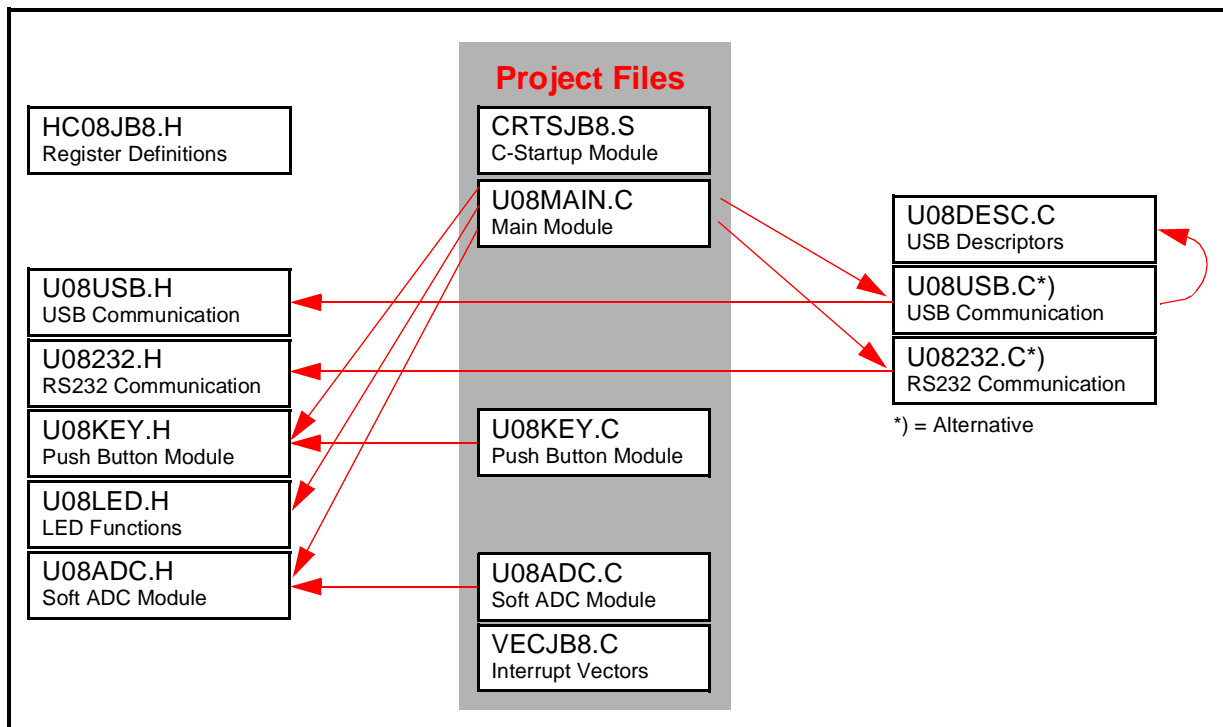

Figure 3-1. Structure and Dependencies of the Firmware Files

The compiler project for the USB08 reference design covers these C modules (see [Figure 3-1](#)):

- [U08MAIN.C](#)
- [U08KEY.C](#)
- [U08ADC.C](#)
- [VECJB8.C](#)

An alternative possibility consists of controlling the translation of the project via a batch file as shown in this example ([BUILD.BAT](#)).

```
cx6808 -v -l u08main.c u08adc.c u08key.c vecjb8.c
clnk -o usb08.h08 usb08.lkf
chex -fm -h -o usb08.s19 usb08.h08
```

This batch file can be invoked under the MS-DOS[®] system environment to translate and link USB08 firmware components. The result of this process is a S-record file named [USB08.S19](#), which can be loaded into the FLASH memory of the MC68HC908JB8.

Another important file for controlling the translation is the linker file [USB08.LKF](#):

```
# USB08 LINK COMMAND FILE
# COSMIC HC08 C COMPILER
#
+seg .text -b 0xdc00 -n .text # program start address
+seg .const -a .text # constants follow code
+seg .bsct -b 0x0040 -n .bsct # zero page start address
+seg .ubsct -a .bsct -n .ubsct # data start address
+seg .data -a .ubsct # data start address
+def __sbss=@.bss # start address of bss
# Put your startup file here
crtsjb8.o # startup routine
# Put your files here
u08main.o
u08key.o
u08adc.o
# "c:\programs\cosmic\cx08\Lib\libi.h08"
#c:\programs\cosmic\cx08\Lib\libm.h08"
+seg .const -b 0xffff0 # vectors start address
# Put your interrupt vectors file here if needed
vecjb8.o
+def __memory=@.bss # symbol used by library
+def __stack=0x013f # stack pointer initial value
```

MS-DOS is a registered trademark of Microsoft Corporation in the United States and/or other countries.

In the linker file:

- The starting addresses of the various segments are set.
- The text segment starts at the address 0xDC00 (for example, at the beginning of the internal FLASH memory).
- The constants immediately follow the text segment.
- The zero page starts at 0x0040 instead of the usual 0x0000.
- The MC68HC908JB8 control registers are located in the address range 0x0000–0x0040.
- The data segment follows the zero page in the random-access memory (RAM).
- The interrupt vectors start at 0xFFFF0 and the stack pointer is set to 0x013F (end of the internal RAM memory).

Table 3-1 shows the approximate values for memory utilization when USB communication has been implemented.

Table 3-1. Memory Utilization

Starting Address	End Address	Length	Contents
0x0000	0x003F	64 byte	MC68HC908JB8 control registers
0x0040	0x0075	53 byte	Variables in RAM
0x0076	0x0117	163 byte	Free RAM
0x0118	0x013F	40 byte	Stack in RAM
0xDC00	0xE2FF	1.8 Kbyte	Code and constant values
0xE300	0xFBFF	6.2 Kbyte	Free FLASH memory
0xFFFF0	0xFFFF	16 byte	Interrupt and reset vectors

3.5 Main Module U08MAIN.C

Which variant to be compiled is specified at the head of this module using the macro `USE_USB_PIPE`. If defined, the USB version will be produced; otherwise, the RS232 version will be produced.

The two versions are formed by merging different “#include” files. In addition, the names of the interface functions used in the main program are standardized. For example:

- If the RS232 version is active, the `getSSCI()` (for receiving a character via RS232) is renamed by a macro to `getPipe()`.
- If the USB version is active, `getPipe()` is mapped to `getUSB()`.

This enables the use of uniform function names in the main program, independent of the version selected in each case.

The function `main()` contains the continuous loop of the master program. As usual, it is called by the C startup module after all fundamental hardware and system initializations are finished. Also, at the beginning of these initializations, the C startup module calls the function `_HC08Setup()`. In this function, all register accesses and initializations, which must take place immediately after system resets, are summarized. The summarizing of these initializations within its own function keeps the C startup module static. It has the advantage that the C startup module does not have to be changed and retranslated, even if further initialization steps become necessary.

At the beginning of function `main()` the peripheral modules used by the program are initialized:

- `initPipe()` — communication module (RS232 or USB)
- `initLED()` — LED readouts
- `initKey()` — keyboard entry
- `initSADC()` — software analog-to-digital converter (ADC)

Subsequently, the `I` flag is deleted to enable global interrupts.

The main program loop uses this operational sequence:

1. An analog-to-digital (A/D) conversion is performed. One of three conversion channels is updated in each cycle run. This procedure was selected because the transformation, with the simple ADC software implemented in the module **U08ADC.C**, takes several milliseconds.
2. Subsequently, the delivery of an 8-byte data telegram by the input pipe is accomplished. This length was chosen because it corresponds to the number of bytes sent by the PC program.

The necessary information for the control of the three LEDs is contained in the first three bytes. If the received byte is 0, the respective LED is switched off; otherwise, it is switched on.

3. To send an answer telegram back at the host PC, first fill the send buffer utilizing the first six bytes of the eight bytes available. In the first three bytes, the status of the input keys is coded. The next three bytes transmit the last values of the three analog converter channels.
4. Now the function `putPipe()` is called eight times to send the data telegram. Afterward, the entire cycle run is repeated.

All further program functions, in particular the communication via USB and the processing of the push button events, are processed by interrupt functions.

3.6 Interrupt and Reset Vector Module VECJB8.C

The file **VECJB8.C** contains the definitions of the interrupt vector table placed at the end of the M68HC08 memory map. The entries in this table are the start addresses of the respective interrupt service routines. The MC68HC908JB8 uses eight (7 + 1) vectors. The last, highest position (address 0xFFFE/0xFFFF) is used by the reset vector.

In the USB08 reference design, the key pad interrupts of the input/output (I/O) port A are used as well as the USB interrupts in case the USB implementation was activated. The other interrupt vectors refer to an empty dummy interrupt service routine (ISR). This dummy ISR is

practically without function; however, it can be used in the debugging phase for seeking out unexpected (spurious) interrupts. In addition, the allocation of all interrupt vectors is important for the implementation of the FLASH memory security feature (read-out protection). For additional information, refer to the *MC68HC908JB8 Technical Data*, Motorola document order number MC68HC908JB8/D.

The reset vector refers to the start address of the application. This point of entrance is located in the C startup module.

3.7 C Startup Module CRTSJB8.S

The C startup module used essentially corresponds to the standard startup module from the Cosmic C Compiler package with one exception. Immediately after a reset (and after the initialization of the stack pointer), a subroutine reference was inserted to `_HC08Setup()`. This subfunction is defined in **U08MAIN.C** and performs urgent accesses to M68HC08 control registers which should be completed immediately after the reset.

3.8 Push Button Module U08KEY.C

Port A (PTA) of the MC68HC908JB8 has eight port bits for keyboard connection. Each of these lines can cause an interrupt. The port bits individually can be configured for use within the MC68HC908JB8 keyboard interrupt module (KBI).

The USB08 evaluation board uses three single keys which are connected to port lines PTA[4:6]. The switch noise reduction is performed via a resistor-capacitor (RC) combination at each key. This combination is made by:

- M68HC08 internal pullup resistors and a capacitor (parallel to the key)
- Hysteresis of the port A input Schmitt triggers

The KBI module of the MC68HC908JB8 greatly simplifies the scanning of the attached buttons. The software necessary for this takes only 20 lines of C code.

The conditions are created in the initialization function `initKey()`. First the internal pullup resistors at the port A pins are activated. A short pulse of an active H level is driven at the port A pins which accelerates the rising of the logic levels at these pins. This prevents a false reading of the initial low level on the lines.

The initialization function ends with the resetting of the status variable, `KeyState`, and the enabling of the keyboard interrupt.

During the manipulation of a key, the interrupt service routine `isrKey()` is called. At port A, the pressed key is seen as a 0 bit. The appropriate bit location is set accordingly in the status variable `KeyState`. By activation of a key the key status is inverted. This implementation simulates an on/off push button.

If the main program wants to know the current status of a key (on/off), it uses the access function `getKey()`. The number of the key (1...) will be handed over as a function argument. The function `getKey()` calculates a bit mask for access to an individual bit of the (internal) status variable `KeyState`. The return value amounts to 0, if the key is off; otherwise, a 1 is returned.

This module provides an easy way to specify the desired number of possible keys. For this purpose, two macros are used. `KEY_MASK` defines the used lines of port A by setting a “one” flag at the appropriate bit location. The macro `KEY_FIRST` defines at which bit location the first key is attached. Some examples:

```
KEY_MASK=0x01;    KEY_FIRST=0;    // one key at PTA[0 ]
KEY_MASK=0x02;    KEY_FIRST=1;    // onea key at PTA[1 ]
KEY_MASK=0x80;    KEY_FIRST=7;    // one key at PTA[7 ]
KEY_MASK=0x70;    KEY_FIRST=4;    // three keys at PTA[4..6 ]
KEY_MASK=0xF0;    KEY_FIRST=4;    // four keys at PTA[4..7 ]
KEY_MASK=0xFF;    KEY_FIRST=0;    // eight keys at PTA[0..7 ]
```

The port bits included in the key scan have to follow one after another.

NOTE: *It has to be pointed out for completeness, that with the KBI module of the MC68HC908JB8 not only single keys but also extensive key fields in matrix arrangement can be easily scanned.*

3.9 LED Control with U08LED.H

Controlling the three light-emitting diodes (LED) attached to port D is easy. For initialization, the data direction of the used port pins PTD[0..2] has to be switched to an output state. The initialization as well as the switching of the LEDs is performed via four macros. Therefore, a header file is enough for the realization of these functions. A special C module is not required in this case.

The LEDs are addressed, beginning with a 1. The switching on of the first LED (at PTD[0]) takes place, for example, by means of:

```
onLED(1);
```

3.10 Software ADC Module U08ADC.C

Although the MC68HC908JB8 does not have an integrated ADC, it is nevertheless possible to measure analog values (and in particular resistance values) in a simple way. For this purpose, an RC combination is attached to a conventional digital port pin and the load time of the capacitor is measured. The working principle is shown in [Figure 3-2](#).

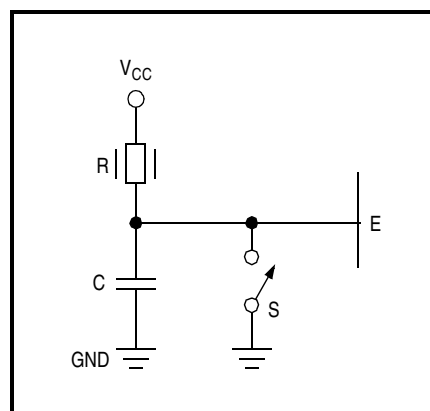

Figure 3-2. Measurement of Resistor Values Using a Digital Input

First, the switch S is closed and the capacitor C uncharged. As soon as the switch S is opened, the charging procedure begins. The voltage at the input E of the microcontroller rises according to the exponential function:

$$U_E(t) = V_{CC} (1 - e^{(-t/RC)})$$

The threshold voltage at the input pin of the MC68HC908JB8, from which a level change from low to high takes place, is approximately 50 percent of the operating voltage V_{CC} . Until this threshold is reached, the loading time, t_x , amounts to:

$$t_x = K * R_x C \text{ with } K \sim 0,7 \text{ for } V_{CC}/2$$

Since k represents a constant value (in the considered short time frame), a linear connection between the measured time and the product $R_x C$ appears. Since C is constant, one can draw a direct conclusion from the charge time to the value of the resistance R_x .

To determine the absolute resistance of R_x , first the value of the capacity C and the constant k have to be determined. However, that is not economical (particularly with series products having a certain distribution of its value). Instead, one can accomplish a calibration cycle before the actual measurement. This calibration cycle uses a reference resistance value R_0 and determines the time t_0 . The following measure cycle uses series connection R_x , consisting of the reference resistance R_0 and the variable resistance R_1 (for example, $R_x = R_0 + R_1$), to determine the time t_x . The result can be calculated using the relationship:

$$R_1/R_0 = (R_x - R_0)/R_0 = (t_x - t_0)/t_0$$

The range of values of the result is between 0 and 1, if $R_{1max} = R_0$.

The software ADC module of the USB08 application serves three A/D channels (see [Section 2. Hardware Description](#)). Reaching the threshold voltage is sensed via the port pins PTE[0..2]. The switch function for charging/discharging the capacitor is realized by switching the port pins as outputs. In contrast to the circuit diagram ([Figure 3-1](#)), the polarity is exchanged (for instance, the point of reference is V_{CC} instead of ground) and the charge of the capacitor is made by activating

the ground potential at the resistors via the port pins PTD[3..5] (calibration cycle) and PTD[6] (measuring cycle).

Before the software of the ADC module can be used, the initialization function `initSADC()` has to be called. In addition, the main timer is required to run with 3 MHz (prescaler 0). The clocking of three impulses per microsecond is the basis of the time measurement in this module.

The function responsible for the A/D conversion of one channel at a time is `getSADC()`. The channel number (1..3) is handled as a parameter. The A/D conversion is performed in the two mentioned steps: calibration and measurement.

The desired 8-bit range for the results (values of 0..255) is a result of scaling of the A/D output. In order to keep the run time of the necessary division and multiplication operations small, the scaling function is implemented using some in-line assembler directives.

A detailed discussion of the software A/D converter used here is contained in the application note entitled *Simple A/D for MCUs without Built-in A/D Converters*, Motorola document order number AN477/D. This application note can be found on the World Wide Web at:

<http://www.motorola.com/semiconductors/>

3.11 RS232 Communication Module U08232.C

The RS232 communication module performs the sending and the receiving of data to the host PC. The RS232 implementation is one of the two possible alternatives. By the definition of the macro `USE_USB_PIPE` in the main module **U08MAIN.C**, it is possible to switch from the RS232 version to the USB version of the communication module.

Since the MC68HC908JB8 does not have a hardware serial communications interface (SCI) peripheral module, an RS232 transceiver has to be implemented by a software-based SCI module. Two general-purpose I/O pins are used as receiving and transmission lines. The timing necessary for the desired baud rate is derived from a time loop.

The module contains these three interface functions:

- `initSSCI()` — initialization of the software SCI module
- `getSSCI()` — receiving of a character
- `putSSCI()` — transmission of a character

The module initialization function `initSSCI()` sets the data direction registers for the output and input port. Before this setting, a 1 is written to the data register of the transmission line so that the output value of this line is the standard high state.

The receive function `getSSCI()` waits until the state of the receiving line changes to low. This indicates the beginning of the start bit of an arriving byte. The following eight data bits are scanned suitably, in each case in the center of the bit time. The result of this scanning is finally returned to the calling function.

The available implementation does not examine whether the arriving stop bit shows incorrect low levels (framing error). Also, an over scanning for the purpose of noise reduction does not take place.

The production of the bit rate is controlled by the module-internal function `delayHalfBit()`. The function is implemented with help from some in-line assembly code to ensure an accurate time performance, which can be simply changed by the user if necessary. The possible changes necessary for the adjustment to different baud rates is documented in the source text on the basis of two examples.

Adjustments regarding the port pins used as sending or receiving lines are easily possible. The module uses five macros for the control and scanning in of these pins. These macros are defined in the head of the file [U08232.C](#). Almost all port pins can be used for the software serial communications interface (SCI) module by changing the bit masks and/or the port designators in these macros.

In this demo application, the moderate baud rate of 2400 baud is selected. An increase to 9600 baud is possible, but tests first must show that the application runs without problems. It has to be taken into account that the bit rate production is determined by a certain number of execution cycles by the central processor unit (CPU), which temporarily

disables any interrupts. Also, in an application with permanent interrupt use, the software SCI should run in an interrupt-controlled way. Since the receiving of a character is performed using port pin PTA7, the use of the keyboard interrupt associated with this pin would be possible for the recognition of the start bit. The timing for the scanning of the following received data bits could be made using the available main timer (TIM) of the MC68HC908JB8 as well as the sending of characters using the PTC0 pin.

3.12 USB Communication Module U08USB.C

The USB communication module **U08USB.C** demonstrates how data can be exchanged between the microcontroller and host PC over an USB connection. This module can be linked (alternatively to the RS232 communication module **U08232.C**) into the USB08 application when the macro `USE_USB_PIPE` in the main module **U08MAIN.C** is activated.

Just like RS232, the USB uses serial streams for the data communication. The substantially more complex operational sequence of the USB can be encapsulated so that the integration into existing projects is possible without problems. Therefore, the USB implementation shown here is just as simple to manage for the firmware programmer as the classical RS232 version. Only three interface functions are needed:

- `initUSB()` — initialization of the USB communication module
- `getUSB()` — receiving a character
- `putUSB()` — transmitting a character

The integrated USB peripheral module of the MC68HC908JB8 is controlled using some control registers within the address range of 0x020 to 0x03F; the function `initUSB()` takes care of the initialization of these registers. In addition, the status of the USB equipment is set to the initial status (**Powered**) and the two software buffers which buffer the sending and/or the receiving of data in the application are initialized.

If data should be received, the routine `getUSB()` is called by the application. First, this routine stays in a waiting loop until data from the

USB peripheral module arrives. As soon as the data has arrived, the next character is taken from the buffer and the read index is incremented. Since we are dealing with a ring buffer, this index, if it overflows beyond the upper buffer border, is set back to the lower buffer border (index 0).

The size of the receiving ring buffer is specified by the macro `MAX_RXBUF_SIZE`. The selected value has to be a power-of-two number.

The transmission function `putUSB()` uses another buffer area which is independent of the receive buffer including index variables for read and write access. Again, the buffer size is specified using a macro (`MAX_TXBUF_SIZE`). Concerning the size, the restriction on power-of-two numbers applies here as well.

The character handed over to `putUSB()` is placed into the buffer. If the buffer is full, the routine waits until the send buffer again is able to store data. After placing the character into the send buffer, the access index variable is updated.

Interrupt-controlled implementation of these functions is performed in the background of the microcontroller application:

- Filling of the receive buffer
- Sending of the characters in the send buffer via the USB

For this purpose, an interrupt-controlled USB handler was implemented and can be used in many other applications without any changes. The principle of operation and the places of possible or necessary modifications are described in detail in [Section 4. Universal Serial Bus \(USB\) Interface](#).

3.13 Compiler Specific Adjustments

The source text modules were written and translated with the M68HC08 Cosmic C Compiler. This compiler supports the complete language scope available for ANSI-C. The porting of the firmware to another M68HC08 ANSI-C compiler should be possible without any problems,

because this application does not use problematic constructions, like bit fields in the source code.

In some places, using individual assembler instructions in the form of in-line assembler directives is considered useful, for example, for the interrupt enable in the main module **U08MAIN.C**. For this purpose, the Cosmic C Compiler offers the following instruction:

```
_asm("<assembly statement >");
```

When using other compilers, similar instructions should be available. However, some small syntactic adjustments can be necessary. Beside the main module, the modules **U08232.C** and **U08ADC.C** also contain such in-line assembler constructions.

The marking of a function as an interrupt service routine is not regulated in the ANSI-C standard. For lack of a uniform regulation, the different compilers handle this necessary marking in a different way. For example, the Cosmic C Compiler uses the modification `@interrupt`:

```
@interrupt void interrupt_handler();
```

Other compilers use “`#pragma`” instructions to mark interrupt functions.

Section 4. Universal Serial Bus (USB) Interface

4.1 Contents

4.2	Introduction	59
4.3	Characteristics of the USB08 Reference Design	60
4.4	USB Basics	62
4.5	USB Implementation in the Reference Design	65
4.5.1	Activation of the USB Module	65
4.5.2	Endpoint Configuration	65
4.5.3	USB Reset	67
4.6	Device Management with Endpoint 0	69
4.6.1	Enumeration	69
4.6.2	Assignment of the Device Address	69
4.6.3	Requesting Descriptors	72
4.6.4	Device Configuration	74
4.6.5	STALL Condition	74
4.7	Data Communication via Endpoints EP1 and EP2	75
4.7.1	Receiving Data	76
4.7.2	Transmission of Data	76
4.8	Host Interaction: Vendor ID and Product ID	78
4.9	Windows Device Driver	78

4.2 Introduction

The universal serial bus (USB) is an interface for the connection of peripheral devices, for example, printers, scanners, keyboards, and pointing devices to a PC or a similar host.

The USB specification⁽¹⁾ which can be found on the World Wide Web at:

<http://www.usb.org>

is an industry standard, which exactly defines this bus system beginning with the electrical interface up to the higher protocol layers to guarantee the inter-operability of all the different devices. A simple way of handling is the most important requirement for USB devices from the view of the user.

Several versions of the USB specification exist. Apart from the already established release 1.1, on which the MC68HC908JB8 and the available reference design is based, the specification 2.0 was compiled in the year 2000 by the USB Implementers Forum (USB-IF). This version ensures compatibility to the version 1.1 and contains the already known speed classifications “low speed” and “full speed”. Beyond that, release 2.0 introduces a high-speed device type. First high-speed devices are expected to be established in the market by end of the year 2001.

The basic specification of the USB is supplemented by several class specifications for certain types of device classes, which can be found frequently (for example, human interface device class for keyboards, mouse pointers, etc.). Further information regarding conditions and contents of basic and class specifications can be found on the World Wide Web at:

<http://www.usb.org>

4.3 Characteristics of the USB08 Reference Design

The USB08 reference design shows, via a detailed example, how the integrated USB module of the Motorola microcontroller unit (MCU) MC68HC908JB8 can be used. The MCU is used for a measuring and control application and exchanges data with a PC via the USB. This reference design shows that communication to a PC using USB can be just as simple as a normal RS232 link.

1. Universal Serial Bus Specification Revision 1.1; September 23, 1998

The integrated USB module of the MC68HC908JB8 works at a data rate of 1.5 Mbit/s, thus it is defined as a low-speed USB device. For measuring and control applications, typically only small data rates are needed, and this is already realized using low-speed USB devices. A low-speed USB device ensures an information flow rate, which can be compared roughly with an RS232 link with 9600 baud. At first glance, that doesn't seem to be much; however, the USB variant offers a set of other advantages.

While RS232 always represents point-to-point connection, USB supports a bus structure. The PC serves as bus master and several USB devices can be attached. If the connections (ports) at the PC (host) are not sufficient, USB hubs can be inserted. Hubs can be cascaded up to five levels. Each USB device is addressed by the host via a unique address. The address range supports up to 127 addresses. Thus, a whole measurement and recording system can be arranged easily using a dozen low-speed USB devices and two or three commercial hubs.

This reference design contains USB08 evaluation board firmware; therefore, this Plug & Play demo application can be evaluated immediately. Beyond that, all source code is provided in the form of C modules for the M68HC08 Cosmic C compiler. The user can use these sources as a starting point for their own USB development.

The most important modules for the USB implementation are the source code modules **U08USB.C**, **U08DESC.C**, and the header file **U08USB.H** (see **Section 3. Software Module Descriptions**). The USB functional description refers to these source code modules.

Administration of the USB device takes the largest portion of the referenced implementation source code. This is done via so-called standard device service requests. These transfers take place via the control endpoint 0 and are multi-level, complex communication procedures. Since the implementation of these complex functions virtually can be transferred as a block from the reference design to any other application, the practical work for the administration of a USB device should not be overestimated. Simply, the actual data communication functions (which take place using the interrupt endpoints 1 and 2) can be adapted to the concrete user application.

4.4 USB Basics

Concerning the electrical interface, the plug and the cable, as well as questions on the bus topology we refer to the *Universal Serial Bus Specification Revision 1.1* standard reference. The volume of information contained in this specification exceeds by far this manual. Also some good introductions are offered by books, for example the book by Kelm⁽¹⁾.

NOTE: *Some terms and procedures from the USB specification, which are important for the implementation of the reference design, will be repeated here and described briefly.*

Packets form the basic modules of the USB communication in the levels above the electrical connection. Packets are atomic, for instance, they cannot be interrupted or divided into sections. The packet types shown in **Table 4-1** are relevant for low-speed USB.

Table 4-1. Low-Speed USB Packet Types

Name	Group	Function
SETUP	Token	Starts a control transfer
IN	Token	Starts a data transfer to the host
OUT	Token	Starts a data transfer to the device
DATA0	Data	Transfers 0 to 8 data bytes
DATA1	Data	As before (toggle Data0/1)
ACK	Handshake	Information was accepted
NAK	Handshake	Busy — send again later
STALL	Handshake	Information was incorrect

In addition to the packets shown in **Table 4-1**, the bus traffic consists of further quasi-static bus conditions (reset, suspend, resume) and the “Keep-alive-EOP” (refer to *Universal Serial Bus Specification Revision 1.1* standard for more detailed information).

1. Kelm, H.J.: USB1.1; Franzis 2000

A USB transaction is a series of packets to transmit information between a host and a device. A transaction is always initiated by sending a token packet (SETUP, IN, or OUT). This packet is always sent by the host because devices cannot initiate a USB transaction. The token packet contains the address and the desired endpoint of the device.

SETUP and OUT packets are supplemented by a DATA packet from the host, which contains up to eight bytes of data. The packets DATA0 and DATA1 are always sent in an alternating sequence. This procedure is called data toggle and serves for error protection. Following the data packet, the device answers with a handshake packet. If the device could receive the data, it sends an ACK packet. If the device was not immediately ready, it sends a NAK packet signalling to the host that the packet should be sent again at a later time. In the event of an error, the device sends a STALL packet.

SETUP Transaction

Host	Host	Device
SETUP (ADDR,EP)	DATA0 (D1..D8)	ACK

OUT Transaction

Host	Host	Device
OUT (ADDR,EP)	DATA0 (D1..D8)	ACK

Regarding **IN** transactions, the data packet is sent by the device and the host closes the transaction with a handshake packet.

IN Transaction

Host	Device	Host
IN (ADDR,EP)	DATA0 (D1..D8)	ACK

Universal Serial Bus (USB) Interface

If the device does not hold any data ready for sending, it sends a busy handshake NAK instead of the data packets.

IN Transaction (Device Busy)

Host	Device
IN (ADDR,EP)	NAK

While the actual data communication via the stream pipes is based on simple IN and OUT transactions, the management of the device uses more complex control transfers via the control endpoint 0. These control transfers are secured using a double handshake. Control transfers consist of two or three transaction stages, like those shown here.

2-Stage Control Transfer (No Data)

Setup Stage	Status Stage
SETUP,DATA0,ACK	IN,DATA1,ACK

3-Stage Control Transfer (Host Read)

Setup Stage	Data Stage	Status Stage
SETUP,DATA0,ACK	IN,DATA1,ACK (...)	OUT,DATA1,ACK

The setup stage starts with a SETUP transaction (see above). The data stage is necessary if data has to be sent from the device to the host and consists of several IN transactions. The status stage serves for the back confirmation that the information was processed correctly. In the status stage, empty DATA1 packets are sent.

4.5 USB Implementation in the Reference Design

The following paragraphs describe the implementation of the USB into the reference design.

4.5.1 Activation of the USB Module

For initialization of the MC68HC908JB8 USB module, the user program must call the initialization routine `initUSB()`. This routine writes all registers with the same default values, which are present after a power-on reset. Beyond that, the USB module is activated by setting the bit `USBEN` in the USB address register `UADDR`.

	Bit 7	6	5	4	3	2	1	Bit 0
Read:	USBEN	UADD6	UADD5	UADD4	UADD3	UADD2	UADD1	UADD0
Write:								
Reset:	0	0	0	0	0	0	0	0

Figure 4-1. USB Address Register (UADDR)

In addition, the bit `PULLEN` in USB control register `UCR3` is set resulting in the internal pullup resistor at D-/PTE4 being activated if this option was selected in the source code. For this, the macro `USB_IPUE` must be defined as 1. Alternatively, it is possible to add an external resistor on the USB08 evaluation board (see [Section 2. Hardware Description](#)).

4.5.2 Endpoint Configuration

The integrated USB module of the MCHC908JB8 supports three endpoints. In addition to the mandatory bidirectional control endpoint `EP0`, two unidirectional interrupt endpoints, `EP1` and `EP2`, are available.

The data direction is always indicated from the view of the host. An IN endpoint serves for the data transfer from the device to the host and an OUT endpoint is used for the data transfer from the host to the device.

`EP1` is always configured as an IN endpoint, since the MCU sends data via this endpoint. The endpoint `EP2` of the MC68HC908JB8 can be

configured as an IN or as an OUT endpoint. The reference design uses this endpoint as an OUT endpoint, to do data transfers to the MCU.

Table 4-2 provides an overview of the endpoint configuration.

Table 4-2. MC68HC908JB8 Endpoint Configuration

Endpoint	Type	Direction	Function
EP0	Control	IN/OUT	Device configuration
EP1	Interrupt	IN	Data transfer to the host
EP2	Interrupt	OUT ^(a)	Data transfer to the device

a. Alternatively as IN configurable, this option is not used here.

Some adjustments in the control registers of the USB module are necessary for the configuration of the endpoints. While EP0 is always active as a control endpoint, the bit ENABLE1 in control register 3 (UCR3) has to be set to activate the endpoint EP1. Likewise, the bit ENABLE2 has to be set for activation of the endpoint EP2.

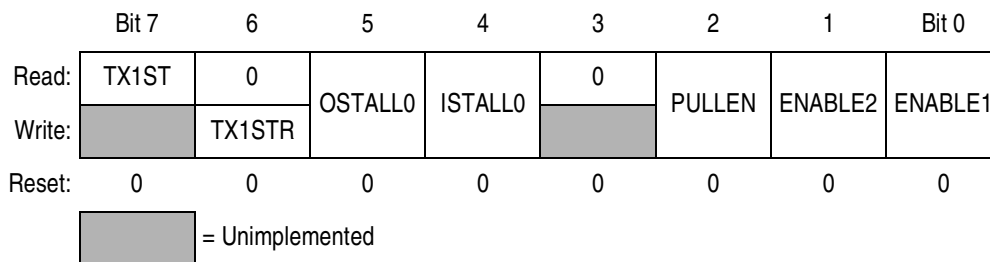

Figure 4-2. USB Control Register 3 (UCR3)

However, the activation of the endpoints EP1 and EP2 takes place not in the initialization routine `initUSB()`, but only after the device receives a USB reset.

4.5.3 USB Reset

An USB reset is an event which is used by the USB hub to reset the attached devices to the initial state. Electrically, the reset signal is a special bus condition (single ended zero) which is initiated by the host and then passed on by the hub(s).

The USB module of the MC68HC908JB8 reacts to this either with a hardware reset or with an interrupt, dependent on the configuration selected in the CONFIG (configuration) register. Since a hardware reset (in particular during the debugging via monitor mode) is not without side effects, the generation of an interrupt is preferred here. For this purpose, the URSTD bit in the CONFIG register has to be set. It has to be considered that a write access to the CONFIG register is possible only once after each power-on reset. Therefore, write access to this control register is done in the function **_HC08Setup()** in the module **U08MAIN.C**.

The USB reset interrupt, together with all the other USB sources of interrupt, points to a central USB interrupt vector. The USB interrupt has, apart from the software interrupt (SWI), the highest priority in the interrupt system of the MC68HC908JB8. The USB interrupt vector is stored at the vector address 0xFFFFA/0xFFFFB (see **3.6 Interrupt and Reset Vector Module VECJB8.C**). In the reference design, it points to the function **isrUSB()**, which is responsible for the entire interrupt-controlled USB handling.

In the interrupt service routine all applicable interrupt flags are successively examined. If it is recognized that the RSTF bit in the USB interrupt register 1 (UIR1) is set, it means that a USB reset interrupt has occurred.

In this case, first the function **initUSB()** is called to set all control registers of the USB module into the default condition. Afterward, the two interrupt endpoints, EP1 and EP2, will be enabled to prepare for the following transfer of data. Now, the local interrupt enable bits TXD0IE, RXD0IE, TXD1IE and RXD1IE in the USB interrupt register 0 (UIR0) are set so they can react on the information sent or received from the endpoints using interrupts. In addition, the end-of-packet interrupt will be enabled with EOPIE (suspend handling).

Universal Serial Bus (USB) Interface

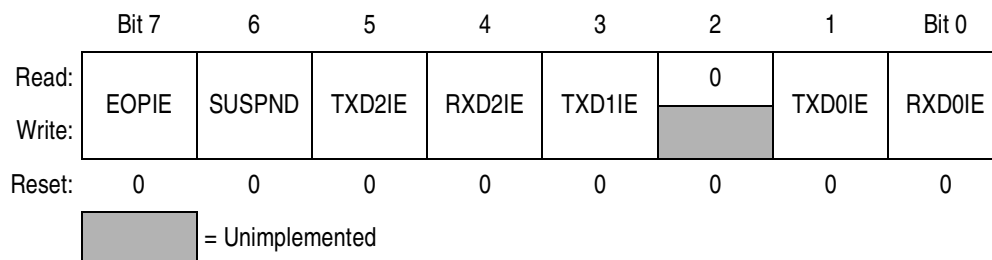

Figure 4-3. USB Interrupt Register 0 (UIR0)

At the end of the USB reset interrupt, the control endpoint 0 will be enabled for receiving, thus the configuration instructions which follow after the reset (device requests) are received by the USB receiver. This option will be enabled by setting the RX0E bit in the USB control register 0 (UCR0).

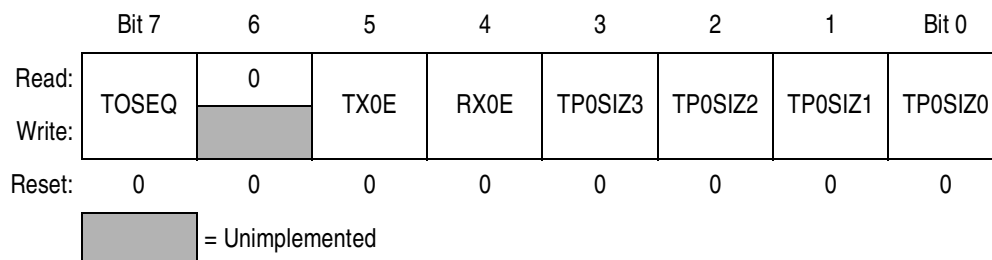

Figure 4-4. USB Control Register 0 (UCR0)

The USB device is now in the DEFAULT state. That means the device is attached to the bus and is supplied with current. In addition, it has received a USB reset and reacts to instructions with the default address zero. For further information, refer to *Universal Serial Bus Specification Revision 1.1, Chapter 9.1 — USB Device States*.

After these fundamental initialization steps, further setup steps summarized under the term of enumeration follow.

4.6 Device Management with Endpoint 0

4.6.1 Enumeration

After the basic initialization described in the previous paragraphs, the USB module is now able to react with an interrupt on packets which are addressed to the control endpoint EP0. Now, the process of the enumeration (that is, the configuration and integration into the system) at the USB is continued.

4.6.2 Assignment of the Device Address

In the following step, the host assigns a unique USB address to the device, which is located in the range from 1 to 127. For this purpose, the host sends a SET_ADDRESS standard device request. Standard device requests are always served by the EP0. These transfers are control transfers which are implemented for the EP0 only (the other endpoints are used exclusively for the data communication by means of interrupt transfers).

USB device requests are started, by the host sending a SETUP packet. The MCU receives this information and generates an EP0 receive interrupt. In the interrupt service routine isrUSB(), the interrupt is identified by the controller on the basis of the RXD0F flag in the USB interrupt register 1 (UIR1).

	Bit 7	6	5	4	3	2	1	Bit 0
Read:	EOPF	RSTF	TXD2F	RXD2F	TXD1F	RESUMF	TXD0F	RXD0F
Write:								
Reset:	0	0	0	0	0	0	0	0

 = Unimplemented

Figure 4-5. USB Interrupt Register 1 (UIR1)

Since a receive interrupt could be initiated by an OUT packet for the endpoint EP0, it must be determined whether the received information

refers to a SETUP or an OUT packet. Therefore, the flag SETUP in the USB status register 0 (USR0) has to be examined. If this flag is set, the last token received by EP0 was a SETUP token and the interrupt routine is branched to the function for handling of SETUP transactions, handleSETUP().

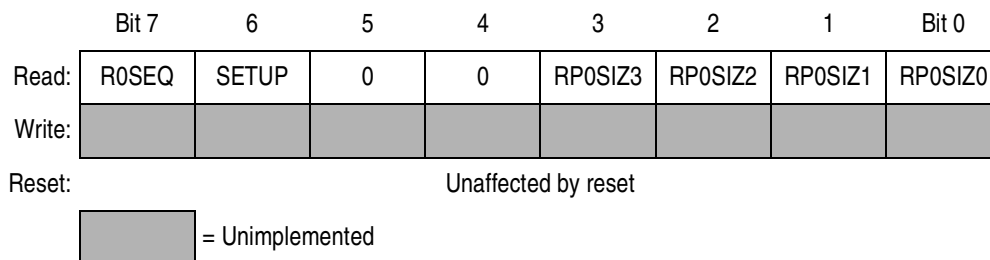

Figure 4-6. USB Status Register 0 (USR0)

In the USB status register 0 (USR0) the function handleSETUP() finds not only the type of the transaction (SETUP or OUT), but can also determine the number of received bytes. In the case of a SETUP transaction, the data length is always defined as eight bytes. Therefore, USR0 should contain the value 0x48.

The eight bytes received by endpoint 0 are available in the eight registers UE0D0–UE0D7 and will be transferred into the buffer variable SetupBuffer. This variable of the type setup_buffer is explained in the following excerpt from [U08USB.H](#).

```

// Structure of Setup Packet sent during
// SETUP Stage of Standard Device Requests
// according to USB1.1 spec page 183
//
typedef struct {
    uchar bmRequestType; // Characteristics (Dir,Type,Recipient)
    uchar bRequest;      // Standard Request Code
    iword wValue;        // Value Field
    iword wIndex;        // Index or Offset Field
    iword wLength;       // No. of Bytes to transfer (Data Stage)
} setup_buffer;
    
```

The field bmRequestType must contain the value 0 in bits 5 and 6; otherwise, it is not a standard device request.

The type of standard request is coded in the field bRequest. For continuation of the enumeration, the host should send the standard device request SET_ADDRESS and the handleSETUP() routine should branch to the function setAddress().

The function first validates the contents of the fields of SetupBuffer. In the case of an error, a STALL handshake is initiated to give the host problem feedback.

Before the device address in the field wValue is finally accepted, the MCU has to prepare the transmission of a receive acknowledgment. This acknowledgement still is completed using the old device address zero. An additional safety feature is the mandatory control transfer status stage.

The handshake takes place via a telegram with a data length of zero, which is requested by the host by means of an IN transaction. For this purpose, the length TP0SIZx is defined as zero and the TX0E bit is set in the USB control register 0 (UCR0). This enables the transmitter of the endpoint 0.

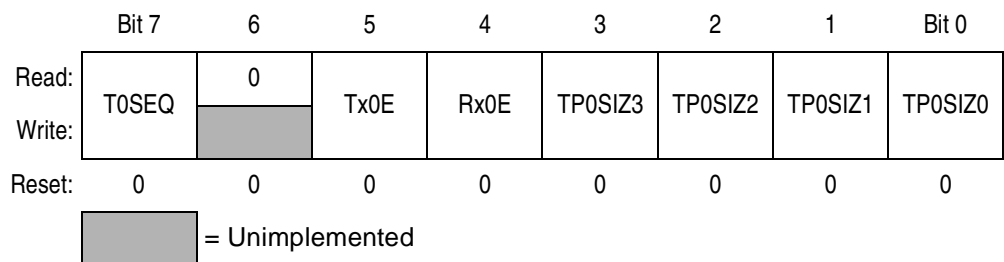

Figure 4-7. USB Control Register 0 (UCR0)

This handshake transaction always uses a DATA1 packet; therefore, T0SEQ is set.

The routine setAddress() now returns to handleSETUP() where the receive interrupt for EP0 is re-enabled. Finally, the MCU terminates the interrupt service routine isrUSB().

The device address is still located in the SetupBuffer. The service routine isrUSB() is again activated by a transmit interrupt for EP0. After decoding, if it was determined that the cause of the interrupt was an IN

transaction, the function `handleIN()` is called. In the field `bRequest` of the `SetupBuffer`, `SET_ADDRESS` is still contained as the current standard request type. The function `handleIN()` now reacts by transferring the device address from the buffer to the USB address register (`UADDR`).

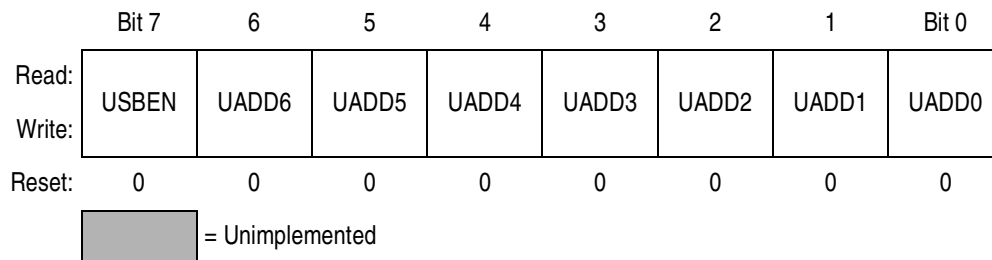

Figure 4-8. USB Address Register (UADDR)

The device is now turned into an `ADDRESSED` status. An exception would be if the transmitted device address was zero again. This case would mean an uncoupling of the device from the USB system.

With the completion of the `IN` transaction as a status stage, the control transfer for the treatment of the standard device request `SET_ADDRESS` is finished. The completion is noted in the `SetupBuffer` by setting the flag `REQUEST_COMPLETE`.

4.6.3 Requesting Descriptors

Further in the process of enumeration, the host will request the configuration of the device. For this purpose, descriptors which contain information about the status and one or more possible configurations, are made available by the device. The host loads these descriptors, selects a suitable driver, and forces the device to take a certain configuration. As a consequence, the device will be ready for use and will be able to transfer data via the interrupt endpoints `EP1` and `EP2`.

Sending descriptor information takes place during a standard device request. The request is of the type `GET_DESCRIPTOR` and in principle is handled the same way as that for the standard device request, `SET_ADDRESS`, described above.

Within the setup stage, the function `handleSETUP()` is called. The request type is recognized as `GET_DESCRIPTOR` and branched to the subfunction `getDescriptor()`. There, it is determined if a device configuration or string descriptor was requested. According to this requirement, a pointer will be set on the respective data source. After examination of the data length, this data will be written into the USB endpoint 0 send registers `UE0D0–UE0D7`.

The number of bytes is limited (at least for low-speed USB devices) to eight bytes per `DATA` packet. If more data has to be transferred, the device has to divide the data into blocks of eight bytes and distribute these portions using several sequential `IN` transactions. The last data block is identified by the host due to a length smaller than eight bytes. That means, if the length of the transmitted data amounts to an integral multiple of eight, there has to be an additional empty `IN` transaction (data length zero).

The data length and the transmitter release bit `TX0E` are inserted into the USB control register 0 (`UCR0`) (see `SET_ADDRESS`), then the data is available for the host to pick up.

If there is only one packet (length smaller eight), the `GET_DESCRIPTOR` standard device request is marked as complete (`REQUEST_COMPLETE`).

If several packets have to be sent, the send buffer is filled up again by the routine `handleIN()` during the following `EP0` transmit interrupt, until all data is sent.

Sequential `IN` transactions are served with interchanging data packets. The interchanging between `DATA0` and `DATA1` packets is called a data toggle and serves for error protection.

Detailed information about the descriptors used in the reference design are contained in [Appendix B. USB08 Descriptors](#).

4.6.4 Device Configuration

After the host processes all descriptors claimed by the device, it will set up the device with a SET_CONFIGURATION standard device request. A device can have several configurations (for example, with different power options, resolutions, or speed options). The configuration characteristics supported by the device are coded in the device descriptors.

The reference design is limited to the simplest case with only one possible configuration. The SET_CONFIGURATION request is passed on by the routine isrUSB() to handleSETUP(), after which branches to setConfiguration() take place. The configuration specified by the host is coded in the field wValue.lo of the structure SetupBuffer. If this field is larger than zero, the USB08 is ready to be put into operation. For this purpose, the transmitter of endpoint 1 and the receiver of endpoint 2 will be enabled and the internal status of the device changed to CONFIGURED.

In reverse, the host is able to return the device to the status ADDRESSED by transmission of a SET_CONFIGURATION instruction with the value 0.

For the status stage of this control transfer, the routine ends by preparing to send an empty DATA1 packet. This is completed by the following IN transaction.

4.6.5 STALL Condition

If the device discovers an error during communication via the USB which requires the involvement of the host, the device sends a STALL packet in place of the usual handshake packets ACK (ready/OK) or NAK (not ready).

To force the device not to send further STALL packets after the recovery of the error, the host can use the standard device request CLEAR_FEATURE. The responsible standard request handler clearFeature():

- Hands over the code for the endpoint concerned (0x81 for EP1, 0x02 for EP2) to wIndex
- Writes ENDPOINT_HALT into wValue
- Forces the deletion of the STALL condition for the endpoint 1 or 2

A STALL condition of the EP0 resulting from an incorrect SETUP request is reset automatically by the next arriving SETUP token.

4.7 Data Communication via Endpoints EP1 and EP2

The transmission of user data from or to the USB device takes place via the endpoints 1 and 2. EP1 is an endpoint of the type IN and serves for sending of information to the host. EP2 possesses the direction OUT and is used by the device to receive data from the host.

All data traffic of the payload endpoints EP1 and EP2, as well as the administrative traffic of the endpoint EP0, leads to interrupt handling via the interrupt service routine isrUSB(). The USB interrupt register 1 (UIR1) contains information about the exact source of the USB interrupt. If the flag TXD1F is set, a transmit complete interrupt was indicated by endpoint 1. If RXD2F is set, an endpoint 2 receive interrupt is pending.

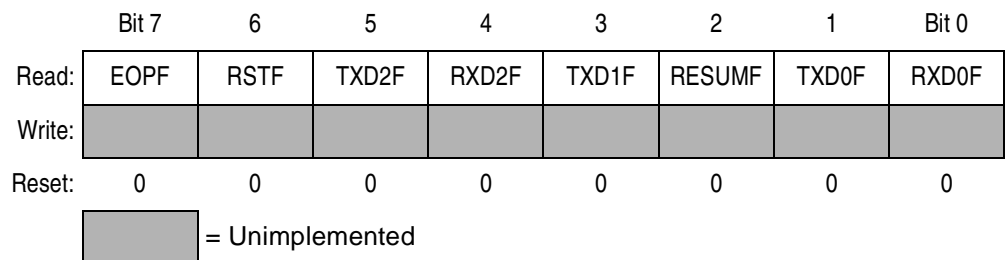

Figure 4-9. USB Interrupt Register 1 (UIR1)

4.7.1 Receiving Data

If data for endpoint 2 arrives, the interrupt handler calls `handleOUT2()`. The number of received bytes is noted in bits `RPSIZ3–RPSIZ0` with the allowed values in the range of 0–8.

	Bit 7	6	5	4	3	2	1	Bit 0
Read:	R2SEQ	TXACK	TXNAK	TXSTL	RP2SIZ3	RP2SIZ2	RP2SIZ1	RP2SIZ0
Write:								
Reset:	0	0	0	0	0U	U	U	U

= Unimplemented
 U = Unaffected

Figure 4-10. USB Status Register 1 (USR1)

The received data bytes are transferred from the USB endpoint data registers `UE2D0–UE2D7` to the buffer `RxBuffer`. This is a software ring buffer, which can be filled by the interrupt service routine `isrUSB()` and be read out by means of `getUSB()`.

If the ring buffer is full, `handleOUT2()` waits until `RxBuffer` is able to store data again. In this case, the USB module answers further transmission attempts of the host with a NAK handshake.

NOTE: *In a real application, you should not leave the buffer unserviced over a longer period of time.*

4.7.2 Transmission of Data

The transmit data for EP1 is placed by the user program, via the function `putUSB()`, into the send buffer `TxBuffer`. This is (just like `RxBuffer`) a ring buffer, which blocks the application as soon as the buffer is about to overflow.

The host polls all interrupt end points cyclically, taking into account a guaranteed maximum latency time. That polling interval can be specified in the endpoint descriptor. For low-speed USB devices with interrupt endpoints the shortest specified polling interval is 10 ms. That means,

after 10 ms the host asks whether further data has to be fetched from endpoint 1 or not.

NOTE: *In practice, the host uses only intervals of 2^n ms, the demanded 10 ms is then rounded to 8 ms.*

The USB interrupt routine is called cyclically and branches to the handler handleIN1. From there, data is taken from the ring buffer TxBuffer (if available) and transferred into the USB endpoint 1 data registers UE1D0–UE1D7. Subsequently, the number of bytes which should be sent is registered in the fields TP1SIZ3–TP1SIZ0. If no data is in the buffer, this number is registered as 0. The T1SEQ bit is inverted to switch between DATA0 and DATA1 packets (data toggle). Finally, by setting the bit TX1E in the USB control register 1 (UCR1), the transmission of the data is enabled.

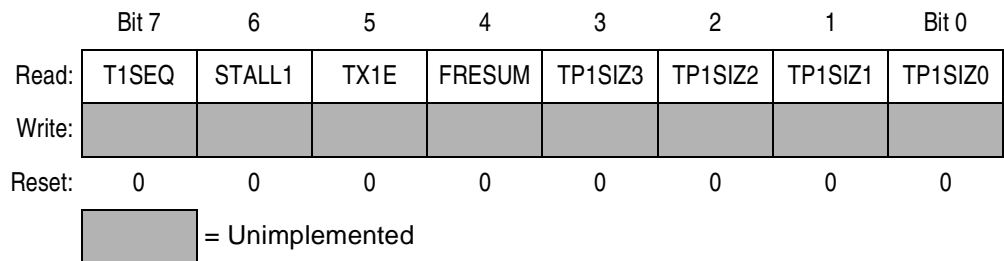

Figure 4-11. USB Control Register 1 (UCR1)

The operation mode selected here is based on a continuous data stream. If there is no transmit data in the buffer, the device will send data packets with zero byte contents. If this condition continues for a longer time, sending of empty data packets means a waste of bus bandwidth. If this turns out as critical, a change of the operation mode is recommended. Alternatively, it is possible to disable TX1E, as long as no data is present in the buffer. Then, the endpoint answers a polling only with a NAK packet and does not occupy any additional bandwidth by sending an empty data packet.

4.8 Host Interaction: Vendor ID and Product ID

Two identifiers are used to mark a USB device and make it possible for the host to assign a suitable driver: The vendor ID and the product ID. Both IDs are registered in the device descriptor of the USB equipment.

1. The vendor ID (VID) marks the manufacturer. Normally, vendor IDs are assigned by the USB Implementers Forum. The requestor is charged for this registration.
2. The product ID is (just like the VID) a 16-bit number. The PID marks a certain product. The allocation is done by the manufacturer of the device. Unlike the VID, for the PID there are no administrative restrictions from the USB Implementers Forum.

The USB08 reference design uses the registered vendor ID of the manufacturer MCT Elektronikladen, which is 0x0C70. The product ID for the demo application is 0x0000.

To avoid collisions and complications, every type of device is requested to have a unique vendor ID and/or product ID. Devices which have fantasy IDs cannot be used as that would lead to the immediate collapse of the compatibility of different devices at the USB.

Registered users of the USB08 evaluation board can receive their own PID out of the PID pool of the VID 0x0C70, which is exclusively allocated to the user. With these unique VID/PID combinations, the user can develop and sell USB equipment without having to request his own vendor ID beforehand.

Contact MCT Elektronikladen for additional information on obtaining a unique USB08 PID. Refer to <http://www.hc08web.de/usb08>

4.9 Windows Device Driver

Both VID and PID represent the search criteria for the suitable Windows device driver. The link between the driver and VID/PID is done by a *.inf file. To deliver to the operating system the suitable driver for the USB equipment, the manufacturer of the USB device has to provide only a data medium, on which (preferably in the root directory) the suitable *.inf

file and the driver file are specified. The Windows Hardware Assistant copies these two files into the appropriate Windows directory and updates the driver data base as necessary. Then, during the following "Plug Event," the Windows operating system finds the driver immediately in this data base.

With the help of Microsoft SDK it would be possible for a USB device manufacturer to develop the necessary kernel mode drivers for themselves. However, this kind of programming task requires a deep knowledge of the structure and working principles of the Windows driver modules. For those engineers, who occasionally do some programming work on a PC, it is urgently recommended not to try such a task.

A possible workaround could be the operation of the USB device using a Windows standard driver for human interface devices (HID). The device class HID summarizes PC input devices, for example, a keyboard attached to the PC. It is possible to camouflage the measuring data as an HID input packet and tunnel through the HID driver. The advantage of this approach is that a kernel mode driver doesn't have to be developed. Instead you can program your own PC application on top of the existing operating system driver.

However, there are two major disadvantages of the HID method. They are:

1. First, the complexity of the USB handling increases, particularly on the firmware side. There are additional procedures, protocols, and descriptors to implement. Definitions of these additions are not a part of the original USB specification, but are in an HID specification, which can be loaded from the USB Web site:

<http://www.usb.org>

2. Secondly and by far more devastating, is the circumstance that half a dozen implementation variants exist. With each version of Windows and each new service pack or release, the user risks that some details of the USB drivers have changed. In this case, the expenses for testing may be quite high.

The USB08 reference design uses a third possibility, the universal USB device driver (USBIO) from the company Thesycon. This third-party USB driver is professionally maintained and updated as soon as new operating system conditions occur. The USBIO driver is used for the USB08 reference design as a free-of-charge adapted "Light EL" version.

For detailed documentation, components, and demo programs refer to:

- **Appendix E. Universal USB Device Driver (USBIO)**
- World Wide Web at <http://www.thesycon.de>

Appendix A. Supported Standard Device Requests

Definition of the supported standard device requests are given here.

Standard Device Request	ID	Supported Options
SET_ADDRESS	5	Any
GET_DESCRIPTOR	6	DEVICE CONFIGURATION STRING
SET_CONFIGURATION	9	0/1
CLEAR_FEATURE	1	ENDPOINT_HALT

Supported Standard Device Requests

Appendix B. USB08 Descriptors

B.1 Contents

B.2	Introduction	83
B.3	Device Descriptor	84
B.4	Configuration Descriptor	84
B.5	Interface Descriptor	85
B.6	Endpoint 1 Descriptor	85
B.7	Endpoint 2 Descriptor	85
B.8	String Descriptors	86

B.2 Introduction

This appendix defines the USB08 descriptors.

B.3 Device Descriptor

```
const device_descriptor DeviceDesc =
{
    // Size of this Descriptor in Bytes
    sizeof(device_descriptor),
    DT_DEVICE,           // Descriptor Type (=1)
    {0x10, 0x01},       // USB Spec Release Number in BCD = 1.10
    0,                   // Device Class Code (none)
    0,                   // Device Subclass Code (none)
    0,                   // Device Protocol Code (none)
    8,                   // Maximum Packet Size for EP0
    {0x70, 0x0c},       // Vendor ID = MCT Elektronikladen
    {0x00, 0x00},       // Product ID = Generic Demo
    {0x00, 0x01},       // Device Release Number in BCD
    1,                   // Index of String Desc for Manufacturer
    2,                   // Index of String Desc for Product
    0,                   // Index of String Desc for SerNo
    1                     // Number of possible Configurations
}; // end of DeviceDesc
```

B.4 Configuration Descriptor

```
const configuration_descriptor ConfigDesc =
{
    // Size of this Descriptor in Bytes
    sizeof(configuration_descriptor),
    DT_CONFIGURATION,   // Descriptor Type (=2)
    {sizeof(configuration_descriptor) + sizeof(interface_descriptor) +
    sizeof(endpoint_descriptor) + sizeof(endpoint_descriptor),
    0x00},              // Total Length of Data for this Conf
    1,                  // No of Interfaces supported by this Conf
    1,                  // Designator Value for *this* Configuration
    0,                  // Index of String Desc for this Conf
    0xc0,               // Self-powered, no Remote-Wakeup
    0                    // Max. Power Consumption in this Conf (*2mA)
}; // end of ConfigDesc
```

B.5 Interface Descriptor

```

const interface_descriptor InterfaceDesc =
{
    // Size of this Descriptor in Bytes
    sizeof(interface_descriptor),
    DT_INTERFACE,           // Descriptor Type (=4)
    0,                      // Number of *this* Interface (0..)
    0,                      // Alternative for this Interface (if any)
    2,                      // No of EPs used by this IF (excl. EP0)
    0xff,                  // IF Class Code (0xff = Vendor specific)
    0x01,                  // Interface Subclass Code
    0xff,                  // IF Protocol Code (0xff = Vendor specific)
    0                      // Index of String Desc for this Interface
}; // end of InterfaceDesc

```

B.6 Endpoint 1 Descriptor

```

const endpoint_descriptor Endpoint1Desc =
{
    // Size of this Descriptor in Bytes
    sizeof(endpoint_descriptor),
    DT_ENDPOINT,          // Descriptor Type (=5)
    0x81,                // Endpoint Address (EP1, IN)
    0x03,                // Interrupt
    {0x08, 0x00},       // Max. Endpoint Packet Size
    10                   // Polling Interval (Interrupt) in ms
}; // end of Endpoint1Desc

```

B.7 Endpoint 2 Descriptor

```

const endpoint_descriptor Endpoint2Desc =
{
    // Size of this Descriptor in Bytes
    sizeof(endpoint_descriptor),
    DT_ENDPOINT,          // Descriptor Type (=5)
    0x02,                // Endpoint Address (EP2, OUT)
    0x03,                // Interrupt
    {0x08, 0x00},       // Max. Endpoint Packet Size
    10                   // Polling Interval (Interrupt) in ms
}; // end of Endpoint2Desc

```

B.8 String Descriptors

```
// Language IDs
//-----
#define SD0LEN 4
//-----

const uchar String0Desc[SD0LEN] = {
    // Size, Type
    SD0LEN, DT_STRING,
    // LangID Codes
    0x09, 0x04
};

// Manufacturer String
//-----
#define SD1LEN sizeof("MCT Elektronikladen")*2
//-----
const uchar String1Desc[SD1LEN] = {
    // Size, Type
    SD1LEN, DT_STRING,
    // Unicode String
    'M', 0,
    'C', 0,
    'T', 0,
    ' ', 0,
    'E', 0,
    'l', 0,
    'e', 0,
    'k', 0,
    't', 0,
    'r', 0,
    'o', 0,
    'n', 0,
    'i', 0,
    'k', 0,
    'l', 0,
    'a', 0,
    'd', 0,
    'e', 0,
    'n', 0
};
```

```

// Product String
//-----
#define SD2LEN sizeof("USB08 Evaluation Board")*2
//-----
const uchar String2Desc[SD2LEN] = {
    // Size, Type
    SD2LEN, DT_STRING,
    // Unicode String
    'U', 0,
    'S', 0,
    'B', 0,
    '0', 0,
    '8', 0,
    ' ', 0,
    'E', 0,
    'v', 0,
    'a', 0,
    'l', 0,
    'u', 0,
    'a', 0,
    't', 0,
    'i', 0,
    'o', 0,
    'n', 0,
    ' ', 0,
    'B', 0,
    'o', 0,
    'a', 0,
    'r', 0,
    'd', 0
};

// Table of String Descriptors
//
uchar * const StringDescTable[] = {
    String0Desc,
    String1Desc,
    String2Desc
};

```

Appendix C. Source Code Files

C.1 Contents

HC908JB8.H	90
U08USB.H	93
U08232.H	96
U08LED.H	96
U08MAIN.C	97
U08DESC.C	100
U08USB.C	104
U08232.C	113
U08KEY.C	116
U08ADC.C	117
VECJB8.C	119
CRTSJB8.S	120
USB08.LKF	121
BUILD.BAT	121
USB08.MAP	122
USB08.S19	125

HC908JB8.H

```

#ifndef __HC08_H
#define __HC08_H1

// Control Register Definitions for HC908JB8 -----

#define _IO_BASE          0
#define _P(off)          *(unsigned char volatile *)(_IO_BASE + off)
#define _LP(off)         *(unsigned short volatile *)(_IO_BASE + off)

#define PTA              _P(0x00)
#define PTB              _P(0x01)
#define PTC              _P(0x02)
#define PTD              _P(0x03)
#define DDRA            _P(0x04)
#define DDRB            _P(0x05)
#define DDRC            _P(0x06)
#define DDRD            _P(0x07)
#define PTE              _P(0x08)
#define DDRE            _P(0x09)
#define TSC              _P(0x0A)
//not implemented (0x0B)
#define TCNTH            _P(0x0C)
#define TCNTL            _P(0x0D)
#define TMODH            _P(0x0E)
#define TMODL            _P(0x0F)
#define TSC0             _P(0x10)
#define TCH0H            _P(0x11)
#define TCH0L            _P(0x12)
#define TSC1             _P(0x13)
#define TCH1H            _P(0x14)
#define TCH1L            _P(0x15)
#define KBSCR            _P(0x16)
#define KBIER            _P(0x17)
#define UIR2             _P(0x18)
#define UCR2             _P(0x19)
#define UCR3             _P(0x1A)
#define UCR4             _P(0x1B)
#define IOCR             _P(0x1C)
#define POCR             _P(0x1D)
#define ISCR             _P(0x1E)
#define CONFIG           _P(0x1F)
#define UE0D0            _P(0x20)
#define UE0D1            _P(0x21)
#define UE0D2            _P(0x22)
#define UE0D3            _P(0x23)
#define UE0D4            _P(0x24)
#define UE0D5            _P(0x25)
#define UE0D6            _P(0x26)
#define UE0D7            _P(0x27)
#define UE1D0            _P(0x28)
#define UE1D1            _P(0x29)
#define UE1D2            _P(0x2A)

```

```

#define UE1D3          _P(0x2B)
#define UE1D4          _P(0x2C)
#define UE1D5          _P(0x2D)
#define UE1D6          _P(0x2E)
#define UE1D7          _P(0x2F)
#define UE2D0          _P(0x30)
#define UE2D1          _P(0x31)
#define UE2D2          _P(0x32)
#define UE2D3          _P(0x33)
#define UE2D4          _P(0x34)
#define UE2D5          _P(0x35)
#define UE2D6          _P(0x36)
#define UE2D7          _P(0x37)
#define UADDR          _P(0x38)
#define UIR0           _P(0x39)
#define UIR1           _P(0x3A)
#define UCR0           _P(0x3B)
#define UCR1           _P(0x3C)
#define USR0           _P(0x3D)
#define USR1           _P(0x3E)
//not implemented (0x3F)

// 16-Bit Registers:
#define TCNT           _LP(0x0C)
#define TMOD           _LP(0x0E)
#define TCH0           _LP(0x11)
#define TCH1           _LP(0x14)

/-- Bit Mask Definitions -----

// Bits in UADDR:
#define BM_USBEN      0x80      // USB Module Enable

// Bits in UIR0:
#define BM_EOPIE      0x80      // End-of-Packet Detect Interrupt Enable
#define BM_RXD2IE     0x10      // EP2 Rx Interrupt Enable
#define BM_TXD1IE     0x08      // EP1 Tx Interrupt Enable
#define BM_TXD0IE     0x02      // EP0 Tx Interrupt Enable
#define BM_RXD0IE     0x01      // EP0 Rx Interrupt Enable

// Bits in UIR1:
#define BM_EOPF       0x80      // End-of-Packet Detect Flag
#define BM_RSTF       0x40      // Clear Reset Indicator Bit
#define BM_RXD2F      0x10      // EP2 Data Receive Flag
#define BM_TXD1F      0x08      // EP1 Data Transmit complete Flag
#define BM_TXD0F      0x02      // EP0 Data Transmit complete Flag
#define BM_RXD0F      0x01      // EP0 Data Receive Flag

// Bits in UIR2:
#define BM_EOPFR      0x80      // End-of-Packet Flag Reset
// #define BM_RSTFR    0x40      // Clear Reset Indicator Bit
#define BM_RXD2FR     0x10      // EP2 Receive Flag Reset
#define BM_TXD1FR     0x08      // EP1 Transmit complete Flag Reset
#define BM_TXD0FR     0x02      // EP0 Transmit complete Flag Reset
#define BM_RXD0FR     0x01      // EP0 Receive Flag Reset
// Bits in UCR0:

```

Source Code Files

```
#define BM_T0SEQ      0x80      // EP0 Tx Sequence Bit (DATA0/1)
#define BM_TX0E      0x20      // EP0 Tx Enable
#define BM_RX0E      0x10      // EP0 Rx Enable
//#define BM_TP0SIZ   0x0f      // EP0 Tx Data Packet Size

// Bits in UCR1:
#define BM_T1SEQ      0x80      // EP1 Tx Sequence Bit (DATA0/1)
#define BM_STALL1     0x40      // EP1 Force Stall Bit
#define BM_TX1E      0x20      // EP1 Tx Enable
//#define BM_TP1SIZ   0x0f      // EP1 Tx Data Packet Size

// Bits in UCR2:
#define BM_STALL2     0x40      // EP2 Force Stall Bit
#define BM_RX2E      0x10      // EP2 Rx Enable

// Bits in UCR3:
#define BM_TX1STR      0x40      // Clear EP0 Transmit-1st Flag
#define BM_OSTALL0     0x20      // EP0 force STALL Bit for OUT Token
#define BM_ISTALL0     0x10      // EP0 force STALL Bit for IN Token
#define BM_PULLEN      0x04      // Pull-up Enable
#define BM_ENABLE2     0x02      // EP2 Enable
#define BM_ENABLE1     0x01      // EP1 Enable

// Bits in USR0:
// #define BM_R0SEQ    0x80      // EP0 Rx Sequence Bit (DATA0/1)
#define BM_SETUP      0x40      // Setup Token Detect Bit
//#define BM_RP0SIZ   0x0f      // EP0 Rx Data Packet Size

// Bits in USR1:
//#define BM_R2SEQ    0x80      // EP2 Rx Sequence Bit (DATA0/1)
#define BM_RP2SIZ     0x0f      // EP2 Rx Data Packet Size

//-----
#endif
```

U08USB.H

```
//=====
// File: U08_USB.H
// Func: Definitions for USB Data Types & Constants
//       Header File for USB08 Demo Application
// Auth: (C)2000 by MCT Elektronikladen GbR, Oliver Thamm
//       http://www.elektronikladen.de/mct
// Rem.: View/Edit this File with TAB-Size=4
//=====

//-- Data Type Definitions -----

typedef struct {                                // Data Type "Intel Word"
    uchar lo;                                  // (High/Low Byte swapped)
    uchar hi;
} iword;

//-----

// Standard Device Descriptor
// according to USB1.1 spec page 197
//
typedef struct {
    uchar bLength;                            // Size of this Descriptor in Bytes
    uchar bDescriptorType;                    // Descriptor Type (=1)
    iword bcdUSB;                              // USB Spec Release Number in BCD
    uchar bDeviceClass;                       // Device Class Code
    uchar bDeviceSubClass;                    // Device Subclass Code
    uchar bDeviceProtocol;                    // Device Protocol Code
    uchar bMaxPacketSize0;                    // Maximum Packet Size for EP0
    iword idVendor;                           // Vendor ID
    iword idProduct;                          // Product ID
    iword bcdDevice;                          // Device Release Number in BCD
    uchar iManufacturer;                      // Index of String Desc for Manufacturer
    uchar iProduct;                           // Index of String Desc for Product
    uchar iSerialNumber;                      // Index of String Desc for SerNo
    uchar bNumConfigurations;                 // Number of possible Configurations
} device_descriptor;

//-----

// Standard Configuration Descriptor
// according to USB1.1 spec page 199
//
typedef struct {
    uchar bLength;                            // Size of this Descriptor in Bytes
    uchar bDescriptorType;                    // Descriptor Type (=2)
    iword wTotalLength;                        // Total Length of Data for this Conf
    uchar bNumInterfaces;                     // No of Interfaces supported by this Conf
    uchar bConfigurationValue;                // Designator Value for *this* Configuration
    uchar iConfiguration;                     // Index of String Desc for this Conf
    uchar bmAttributes;                       // Configuration Characteristics (see below)
    uchar bMaxPower;                          // Max. Power Consumption in this Conf (*2mA)
} configuration_descriptor;
```

Source Code Files

```
//-----  
  
// Standard Interface Descriptor  
// according to USB1.1 spec page 202  
//  
typedef struct {  
    uchar bLength;           // Size of this Descriptor in Bytes  
    uchar bDescriptorType;   // Descriptor Type (=4)  
    uchar bInterfaceNumber;  // Number of *this* Interface (0..)  
    uchar bAlternateSetting; // Alternative for this Interface (if any)  
    uchar bNumEndpoints;     // No of EPs used by this IF (excl. EP0)  
    uchar bInterfaceClass;   // Interface Class Code  
    uchar bInterfaceSubClass; // Interface Subclass Code  
    uchar bInterfaceProtocol; // Interface Protocol Code  
    uchar iInterface;        // Index of String Desc for this Interface  
} interface_descriptor;  
  
//-----  
  
// Standard Endpoint Descriptor  
// according to USB1.1 spec page 203  
//  
typedef struct {  
    uchar bLength;           // Size of this Descriptor in Bytes  
    uchar bDescriptorType;   // Descriptor Type (=5)  
    uchar bEndpointAddress;  // Endpoint Address (Number + Direction)  
    uchar bmAttributes;      // Endpoint Attributes (Transfer Type)  
    iword wMaxPacketSize;    // Max. Endpoint Packet Size  
    uchar bInterval;        // Polling Interval (Interrupt) in ms  
} endpoint_descriptor;  
  
//-----  
  
// Structure of Setup Packet sent during  
// SETUP Stage of Standard Device Requests  
// according to USB1.1 spec page 183  
//  
typedef struct {  
    uchar bmRequestType;     // Characteristics (Direction,Type,Recipient)  
    uchar bRequest;         // Standard Request Code  
    iword wValue;           // Value Field  
    iword wIndex;          // Index or Offset Field  
    iword wLength;         // Number of Bytes to transfer (Data Stage)  
} setup_buffer;  
  
//-----  
  
// USB Status Codes  
//  
#define US_ATTACHED          0x00    // (not used here)  
#define US_POWERED          0x01  
#define US_DEFAULT          0x02  
#define US_ADDRESSED        0x03  
#define US_CONFIGURED       0x04  
#define US_SUSPENDED        0x80
```

```
//-----
// USB Standard Device Request Codes
// according to USB1.1 spec page 187
//
#define GET_STATUS          0x00
#define CLEAR_FEATURE       0x01
#define SET_FEATURE         0x03
#define SET_ADDRESS         0x05
#define GET_DESCRIPTOR       0x06
#define SET_DESCRIPTOR      0x07          // optional
#define GET_CONFIGURATION    0x08
#define SET_CONFIGURATION    0x09
#define GET_INTERFACE        0x0a
#define SET_INTERFACE        0x0b
#define SYNCH_FRAME         0x0c          // optional

#define REQUEST_COMPLETE     0xff          // not part of the Standard - just
                                          // a Flag to indicate that the recent
                                          // Request has been finished
//-----

// Descriptor Types
// according to USB1.1 spec page 187
//
#define DT_DEVICE            1
#define DT_CONFIGURATION     2
#define DT_STRING            3
#define DT_INTERFACE         4
#define DT_ENDPOINT          5

//-----

// Function Prototypes
//
void initUSB();
uchar getUSB();
void putUSB(uchar c);
@interrupt void isrUSB();

//=====
```

U08232.H

```
//=====
// File: U08_232.H
// Func: Header File for RS232 Module of USB08 Demo App
// Ver.: 1.00
// Auth: (C)2000,2001 by Oliver Thamm
//       MCT Elektronikladen GbR
//       http://hc08web.de/usb08
// Rem.: View/Edit this File with TAB-Size=4
//=====

//-- Function Prototypes -----

void initSSCI();
void putSSCI(char c);
char getSSCI();

//=====
```

U08LED.H

```
//=====
// File: U08LED.H
// Func: LED Functions for USB08
// Auth: (C)2000 by MCT Elektronikladen GbR, Oliver Thamm
//       http://www.elektronikladen.de/mct
//=====

// No code in this Module - just Macros!

#define initLED()          (DDRD |= 0x07)
#define toggleLED(x)      (PTD ^= (1 << (x-1)))
#define offLED(x)         (PTD |= (1 << (x-1)))
#define onLED(x)          (PTD &= ~(1 << (x-1)))

//=====
```

U08MAIN.C

```
//=====
// File: U08MAIN.C
// Func: Main Module for USB08 Demo Application
// Ver.: 1.00
// Auth: (C)2000,2001 by Oliver Thamm, MCT Elektronikladen GbR
//       http://hc08web.de/usb08
// Make: Build the project using U08MAIN.C, U08KEY.C,
//       and VECJB8.C, use CRTSJB8.S as C-Startup Module
// Rem.: View/Edit this File with TAB-Size=4
//=====

//-- Select Interface! -----

#define USE_USB_PIPE           // by defining or NOT defining this
                              // label before compiling, you can
                              // select the communication interface
                              // (if defined => USB, if not => RS232)

//-- Includes -----

#include "hc08jb8.h"           // HC908JB8 Register and Bitmap Definitions
#include "u08key.h"            // Keyboard Module Header File
#include "u08led.h"            // LED Module Header File (just Macros)
#include "u08adc.h"            // Soft ADC Module Header File

//-- Compiler-dependent Stuff -----

#define cli()                 _asm("cli")
#define nop()                 _asm("nop")

//-- Data Type Definitions -----

typedef unsigned char uchar;

//-- Code Starts here -----

#ifdef USE_USB_PIPE
#include "u08usb.c"            // use USB implementation
#define initPipe              initUSB
#define getPipe                getUSB
#define putPipe                putUSB
#else
#include "u08232.c"            // use RS232 implementation
#define initPipe              initSSCI
#define getPipe                getSSCI
#define putPipe                putSSCI
@interrupt void isrUSB() { }
#endif

//-----
```

Source Code Files

```
// Things that should be done immediately after Reset
// (this is called by the C-Startup Module)
//
void _HC08Setup() {
    CONFIG = 0x21;           // USB Reset Disable, COP Disable
    TSC     = 0x00;         // clear TSTOP, Prescaler=0
}

//-----

// Dummy Interrupt Handler
// Place a Breakpoint here in case you are looking for spurious Interrupts
//
@interrupt void isrDummy() {
    nop();                  // just for Debugging
}

//-----

void main() {

    uchar n, a;
    uchar io_buffer[8];
    uchar adc[3];

    initPipe();             // init RS232 or USB Pipe
    initLED();              // init LED Output
    initKey();              // init Key Input
    initSADC();             // init Soft ADC

    cli();

    a = 0;
    while(1) {

        // update ADC results (1 out of 3 at one time)

        adc[a] = getSADC(a+1);
        if(++a==3) a=0;

        // get data from input pipe

        n=0;
        do {
            io_buffer[n++] = getPipe();
        } while(n<8);

        // process input data

        if(io_buffer[0]==0) offLED(1);
        else onLED(1);
        if(io_buffer[1]==0) offLED(2);
        else onLED(2);
        if(io_buffer[2]==0) offLED(3);
        else onLED(3);
    }
}
```

```
// send data to output pipe

io_buffer[0] = getKey(1);
io_buffer[1] = getKey(2);
io_buffer[2] = getKey(3);
io_buffer[3] = adc[0];
io_buffer[4] = adc[1];
io_buffer[5] = adc[2];

n=0;
do {
    putPipe(io_buffer[n++]);
    } while(n<8);

    }
}

//=====
```

U08DESC.C

```
//=====
// File: U08DESC.C
// Func: Device-, Configuration- and String-Descriptors for
//       USB08 Demo Application (all const Data, placed in Flash-ROM)
// Ver.: 1.00
// Auth: (C)2000,2001 by Oliver Thamm, MCT Elektronikladen GbR
//       http://hc08web.de/usb08
// Rem.: View/Edit this File with TAB-Size=4
//=====

//-----

const device_descriptor DeviceDesc =
{
    sizeof(device_descriptor),          // Size of this Descriptor in Bytes
    DT_DEVICE,                          // Descriptor Type (=1)
    {0x10, 0x01},                       // USB Spec Release Number in BCD = 1.10
    0,                                   // Device Class Code (none)
    0,                                   // Device Subclass Code (none)
    0,                                   // Device Protocol Code (none)
    8,                                   // Maximum Packet Size for EP0
    {0x70, 0x0c},                       // Vendor ID = MCT Elektronikladen
    {0x00, 0x00},                       // Product ID = Generic Demo
    {0x00, 0x01},                       // Device Release Number in BCD
    1,                                   // Index of String Desc for Manufacturer
    2,                                   // Index of String Desc for Product
    0,                                   // Index of String Desc for SerNo
    1,                                   // Number of possible Configurations
}; // end of DeviceDesc

//-----

const configuration_descriptor ConfigDesc =
{
    sizeof(configuration_descriptor),    // Size of this Descriptor in Bytes
    DT_CONFIGURATION, // Descriptor Type (=2)
    {sizeof(configuration_descriptor) + sizeof(interface_descriptor) +
    sizeof(endpoint_descriptor) + sizeof(endpoint_descriptor),
    0x00},                               // Total Length of Data for this Conf
    1,                                   // No of Interfaces supported by this Conf
    1,                                   // Designator Value for *this* Configuration
    0,                                   // Index of String Desc for this Conf
    0xc0,                               // Self-powered, no Remote-Wakeup
    0,                                   // Max. Power Consumption in this Conf (*2mA)
}; // end of ConfigDesc

//-----
```

```

const interface_descriptor InterfaceDesc =
    {
        // Size of this Descriptor in Bytes
        sizeof(interface_descriptor),
        DT_INTERFACE, // Descriptor Type (=4)
        0, // Number of *this* Interface (0..)
        0, // Alternative for this Interface (if any)
        2, // No of EPs used by this IF (excl. EP0)
        0xff, // IF Class Code (0xff = Vendor specific)
        0x01, // Interface Subclass Code
        0xff, // IF Protocol Code (0xff = Vendor specific)
        0 // Index of String Desc for this Interface
    }; // end of InterfaceDesc

//-----

const endpoint_descriptor Endpoint1Desc =
    {
        // Size of this Descriptor in Bytes
        sizeof(endpoint_descriptor),
        DT_ENDPOINT, // Descriptor Type (=5)
        0x81, // Endpoint Address (EP1, IN)
        0x03, // Interrupt
        {0x08, 0x00}, // Max. Endpoint Packet Size
        10 // Polling Interval (Interrupt) in ms
    }; // end of Endpoint1Desc

//-----

const endpoint_descriptor Endpoint2Desc =
    {
        // Size of this Descriptor in Bytes
        sizeof(endpoint_descriptor),
        DT_ENDPOINT, // Descriptor Type (=5)
        0x02, // Endpoint Address (EP2, OUT)
        0x03, // Interrupt
        {0x08, 0x00}, // Max. Endpoint Packet Size
        10 // Polling Interval (Interrupt) in ms
    }; // end of Endpoint2Desc

//-----

// Language IDs
//-----
#define SD0LEN 4
//-----

const uchar String0Desc[SD0LEN] = {
    // Size, Type
    SD0LEN, DT_STRING,
    // LangID Codes
    0x09, 0x04
};

```

```
// Manufacturer String
//-----
#define SD1LEN sizeof("MCT Elektronikladen")*2
//-----
const uchar String1Desc[SD1LEN] = {
    // Size, Type
    SD1LEN, DT_STRING,
    // Unicode String
    'M', 0,
    'C', 0,
    'T', 0,
    ' ', 0,
    'E', 0,
    'l', 0,
    'e', 0,
    'k', 0,
    't', 0,
    'r', 0,
    'o', 0,
    'n', 0,
    'i', 0,
    'k', 0,
    'l', 0,
    'a', 0,
    'd', 0,
    'e', 0,
    'n', 0
};
```

```

// Product String
//-----
#define SD2LEN sizeof("USB08 Evaluation Board")*2
//-----
const uchar String2Desc[SD2LEN] = {
    // Size, Type
    SD2LEN, DT_STRING,
    // Unicode String
    'U', 0,
    'S', 0,
    'B', 0,
    '0', 0,
    '8', 0,
    ' ', 0,
    'E', 0,
    'v', 0,
    'a', 0,
    'l', 0,
    'u', 0,
    'a', 0,
    't', 0,
    'i', 0,
    'o', 0,
    'n', 0,
    ' ', 0,
    'B', 0,
    'o', 0,
    'a', 0,
    'r', 0,
    'd', 0
};
// Table of String Descriptors
//
uchar * const StringDescTable[] = {
    String0Desc,
    String1Desc,
    String2Desc
};

//=====

```

U08USB.C

```
//=====
// File: U08USB.C
// Func: USB Implementation Module for USB08 Demo Application
// Ver.: 1.00
// Auth: (C)2000,2001 by Oliver Thamm, MCT Elektronikladen GbR
//       http://hc08web.de/usb08
// Rem.: View/Edit this File with TAB-Size=4
//=====

//-----
#include "u08usb.h"           // Definitions for USB Data Types & Constants
#include "u08desc.c"         // const USB Descriptor Data
//-----

// Source Code Option - set as required by Hardware!
//
#define USB_IPUE1             // Internal Pull-up Enable
                             // 1=Enable(use build-in Pull-up Resistor)
                             // 0=Disable (external Pull-up required)

//-- Variables -----

volatile uchar USB_State;

#define MAX_TXBUF_SIZE 16    // must be 2^x!
volatile uchar TxBuffer[MAX_TXBUF_SIZE];
volatile uchar TxBuf_RdIdx;
volatile uchar TxBuf_WrIdx;

#define MAX_RXBUF_SIZE 16    // must be 2^x!
volatile uchar RxBuffer[MAX_RXBUF_SIZE];
volatile uchar RxBuf_RdIdx;
volatile uchar RxBuf_WrIdx;

volatile uchar SuspendCounter;

setup_buffer SetupBuffer;
uchar SetupSize;
uchar * SetupDataPtr;

uchar R0Sequence;           // DATA0/1 Flag for EP0 Rx
uchar R2Sequence;           // DATA0/1 Flag for EP2 Rx

//-----

// Force STALL Condition for EP0 (both IN and OUT)
// as a Response to an invalid SETUP Request
// Flags will be auto-cleared by the next SETUP Token
//
void forceSTALL() {
    UCR3 |= BM_OSTALL0 + BM_ISTALL0;
}

```



```
//-----
#define ENDPOINT_HALT0x00
#define RT_ENDPOINT0x02

// CLEAR_FEATURE Standard Device Request Handler
// called by handleSETUP();
//
void clearFeature() {

    if( SetupBuffer.wValue.hi ||
        SetupBuffer.wIndex.hi ||
        SetupBuffer.wLength.hi ||
        SetupBuffer.wLength.lo) // check 0-fields
        forceSTALL();
    else if((SetupBuffer.bmRequestType == RT_ENDPOINT) &&
            (SetupBuffer.wValue.lo == ENDPOINT_HALT) &&
            ((SetupBuffer.wIndex.lo==0x81) || (SetupBuffer.wIndex.lo==0x02))) {
        // clear EP1/2 Force STALL Bit
        if(SetupBuffer.wIndex.lo == 0x81) { // EP1
            UCR1 &= ~(BM_T1SEQ+BM_STALL1); // clear STALL, Sequence = DATA0
        }
        else { // EP2
            UCR2 &= ~BM_STALL2; // clear STALL
            R2Sequence = 0; // Sequence = DATA0
        }
        // prepare to send empty DATA1 at next IN Transaction
        UCR0 = BM_T0SEQ + BM_TX0E + 0;
    }
    else forceSTALL();
}

//-----

// SET_ADDRESS Standard Device Request Handler
// called by handleSETUP();
//
void setAddress() {

    if( SetupBuffer.wIndex.hi ||
        SetupBuffer.wIndex.lo ||
        SetupBuffer.wLength.hi ||
        SetupBuffer.wLength.lo ||
        SetupBuffer.wValue.hi ||
        (SetupBuffer.wValue.lo & 0x80))
        forceSTALL();
    else {
        // prepare to send empty DATA1 at next IN Transaction
        UCR0 = BM_T0SEQ + BM_TX0E + 0;
    }
}

//-----
```

Source Code Files

```
// SET_CONFIGURATION Standard Device Request Handler
// called by handleSETUP();
//
void setConfiguration() {

    if( SetupBuffer.wIndex.hi ||
        SetupBuffer.wIndex.lo ||
        SetupBuffer.wLength.hi ||
        SetupBuffer.wLength.lo ||
        SetupBuffer.wValue.hi ||
        (SetupBuffer.wValue.lo > 1) ||
        (USB_State == US_DEFAULT)) {
        forceSTALL();
    }
    else {
        if(SetupBuffer.wValue.lo > 0) {
            // no need to remember the Configuration Value
            // since we support only one Configuration anyway
            USB_State = US_CONFIGURED;
            // Activate Interrupt Endpoints, reset STALL and DATA-Toggle
            UCR1 = BM_TX1E + 0;           // EP1 Tx Enable, Data Size is 0
            UCR2 = BM_RX2E;             // EP2 Rx Enable
        }
        else {
            // Zero means: go back to Adressed State
            USB_State = US_ADDRESSED;
            UCR1 = 0;                   // deactivate EP1
            UCR2 = 0;                   // deactivate EP2
        }
        // prepare to send empty DATA1 at next IN Transaction
        UCR0 = BM_T0SEQ + BM_TX0E + 0;
    }
}

//-----
```

```

// GET_DESCRIPTOR Standard Device Request Handler
// called by handleSETUP();
//
void getDescriptor() {

    uchar n;
    uchar *dest;

    switch(SetupBuffer.wValue.hi) {

        case DT_DEVICE:                // Get Device Descriptor
            SetupDataPtr = (uchar *)&DeviceDesc;
            SetupSize = DeviceDesc.bLength;
            break;

        case DT_CONFIGURATION:         // Get Configuration Descriptor
            SetupDataPtr = (uchar *)&ConfigDesc;
            SetupSize = ConfigDesc.wTotalLength.lo;
            break;

        case DT_STRING:                // Get String Descriptor
            // ### Table Index Boundary should be checked
            SetupDataPtr = StringDescTable[SetupBuffer.wValue.lo];
            SetupSize = *SetupDataPtr;
            break;

        default:
            forceSTALL();
            break;
    }

    if( SetupBuffer.wValue.hi == DT_DEVICE ||
        SetupBuffer.wValue.hi == DT_CONFIGURATION ||
        SetupBuffer.wValue.hi == DT_STRING) {

        // check if requested Length is less than Descriptor Length
        if((SetupBuffer.wLength.lo < SetupSize) && (SetupBuffer.wLength.hi == 0))
            SetupSize = SetupBuffer.wLength.lo;
        // copy (up to) 8 Bytes to EP0 Data Registers
        n = 0;
        dest = (uchar *)&UE0D0;
        while(SetupSize!=0 && n<8) {
            *dest = *SetupDataPtr;
            dest++;
            SetupDataPtr++;
            SetupSize--;
            n++;
        }
        // prepare to send n Bytes as DATA1 at next IN Transaction
        // Rem: RX0E (currently disabled) will be re-enabled at end of handleSETUP()
        UCR0 = BM_T0SEQ + BM_TX0E + n;
        // check if this is the last DATA packet to send
        if(n < 8) SetupBuffer.bRequest = REQUEST_COMPLETE;
    }
}

//-----

```

Source Code Files

```
void handleSETUP() {

    UCR0 &= ~BM_RX0E;                // Deactivate EP0 Receiver
    UIR2 = BM_RXD0FR;                // Reset EP0 Receive Flag

    SetupBuffer = *(setup_buffer *)(&UE0D0);

    if(USR0 != 0x48) {                // SETUP Transaction must be DATA0 with Size=8
        forceSTALL();                // otherwise we have an Error Condition
    }
    else {                             // now we will check the Request Type
        if((SetupBuffer.bmRequestType & 0x60) != 0) {
            forceSTALL();            // Non-Standard Requests will not be handled!
        }
        else {                         // Standard Request Decoder:
            switch(SetupBuffer.bRequest) {
                case CLEAR_FEATURE:    // 1
                    clearFeature();
                    break;
                case SET_ADDRESS:      // 5
                    setAddress();
                    break;
                case GET_DESCRIPTOR:   // 6
                    getDescriptor();
                    break;
                case SET_CONFIGURATION: // 9
                    setConfiguration();
                    break;
                default:
                    forceSTALL();
                    break;
            }
        }
    }
    UCR0 |= BM_RX0E;                // Activate EP0 Receiver
}

//-----

void handleOUT() {

    UCR0 &= ~(BM_RX0E+BM_TX0E);      // Deactivate EP0 Receiver + Transmitter
    UIR2 = BM_RXD0FR;                // Reset EP0 Receive Flag

    // OUT Transactions over EP0 appear as Status Stage
    // of a Standard Device Request only

    UCR0 |= BM_RX0E;                // Activate EP0 Receiver
}

//-----
```

```

void handleIN() {

    uchar n;
    uchar *dest;

    UCR0 &= ~BM_TX0E;           // Deactivate EP0 Transmitter
    UIR2 = BM_TXD0FR;          // Reset EP0 Transmit complete Flag

    switch(SetupBuffer.bRequest) {
        case SET_ADDRESS:
            UADDR = SetupBuffer.wValue.lo | BM_USBEN;
            if(SetupBuffer.wValue.lo != 0) USB_State = US_ADDRESSED;
            else USB_State = US_DEFAULT;
            SetupBuffer.bRequest = REQUEST_COMPLETE;
            break;
        case GET_DESCRIPTOR:
            // copy (up to) 8 Bytes to EP0 Data Registers
            n = 0;
            dest = (uchar *)&UE0D0;
            while(SetupSize!=0 && n<8) {
                *dest = *SetupDataPtr;
                dest++;
                SetupDataPtr++;
                SetupSize--;
                n++;
            }
            // prepare to send n Bytes at next IN Transaction
            // toggle DATA0/1
            UCR0 = ((UCR0^BM_T0SEQ) & BM_T0SEQ) + BM_TX0E + BM_RX0E + n;
            // check if this is the last DATA packet to send
            if(n < 8) SetupBuffer.bRequest = REQUEST_COMPLETE;
            break;
        case CLEAR_FEATURE:
        case SET_CONFIGURATION:
            // nothing to do - handshake finished
            SetupBuffer.bRequest = REQUEST_COMPLETE;
            break;
        case REQUEST_COMPLETE:
            // Request is finished - just clear the TXD0F Flag (see above)
            // and do not re-enable EP0 Transmitter, since there is no more
            // data to send
            break;
        default:
            forceSTALL();
            break;
    }
}

//-----

```

Source Code Files

```
// handle IN Packet Transmit complete over EP1
//
void handleIN1() {

    uchar n;
    uchar *dest;

    UCR1 &= ~BM_TX1E;           // Deactivate EP1 Transmitter
    UIR2 = BM_TXD1FR;          // Reset EP1 Transmit complete Flag

    // refill EP1 Tx Data Buffer
    n = 0;
    dest = &UE1D0;
    while((TxBuf_RdIdx != TxBuf_WrIdx) && n<8) {
        *dest = TxBuffer[TxBuf_RdIdx];
        TxBuf_RdIdx = (TxBuf_RdIdx+1) & (MAX_TXBUF_SIZE-1);
        dest++;
        n++;
    }
    // Activate EP1 Transmitter to send n Bytes
    UCR1 = ((UCR1^BM_T1SEQ) & BM_T1SEQ) + BM_TX1E + n;
}

//-----
// handle OUT Packet received over EP2
//
void handleOUT2() {

    uchar n;
    uchar newIdx;
    uchar *src;

    UCR2 &= ~BM_RX2E;           // Deactivate EP2 Receiver
    UIR2 = BM_RXD2FR;          // Reset EP2 Receive Flag

    // ### Sender's DATA Toggle should be checked!

    // read out EP2 Rx Data Buffer
    src = &UE2D0;
    n = USR1 & BM_RP2SIZ;       // Check Transfer Size
    while(n) {
        newIdx = (RxBuf_WrIdx+1) & (MAX_RXBUF_SIZE-1);
        while(newIdx == RxBuf_RdIdx)
            ;                   // wait if TxBuffer is full
        RxBuffer[RxBuf_WrIdx] = *src;
        RxBuf_WrIdx = newIdx;
        src++;
        n--;
    }
    UCR2 = BM_RX2E;           // Activate EP2 Receiver
}

//-----
```

```

void initUSB() {

    UADDR = BM_USBEN + 0;           // USB enable, default address
    UCR0 = 0;                       // reset EP0
    UCR1 = 0;                       // reset EP1
    UCR2 = 0;                       // reset EP2
    UCR3 = BM_TX1STR +             // clear TX1ST Flag
           USB_IPUE*BM_PULLEN;    // enable/disable internal Pull-up
    UCR4 = 0;                       // USB normal operation
    UIR0 = 0;                       // disable Interrupts
    UIR2 = 0xff;                   // clear all Flags in UIR1
    R0Sequence = 0;                // EP0 Rx starts with DATA0
    R2Sequence = 0;                // EP2 Rx starts with DATA0
    USB_State = US_POWERED;        // powered, but not yet reset
    TxBuf_RdIdx = 0;                // reset Buffer Indexes
    TxBuf_WrIdx = 0;
    RxBuf_RdIdx = 0;
    RxBuf_WrIdx = 0;
}

//-----

uchar getUSB() {

    uchar c;

    while(RxBuf_RdIdx == RxBuf_WrIdx)
        ; // wait if RxBuffer is empty
    c = RxBuffer[RxBuf_RdIdx];
    RxBuf_RdIdx = (RxBuf_RdIdx+1) & (MAX_RXBUF_SIZE-1);
    return c;
}

//-----

void putUSB(uchar c) {

    uchar newIdx;

    newIdx = (TxBuf_WrIdx+1) & (MAX_TXBUF_SIZE-1);
    while(newIdx == TxBuf_RdIdx)
        ; // wait if TxBuffer is full
    TxBuffer[TxBuf_WrIdx] = c;
    TxBuf_WrIdx = newIdx;
}

//-----

```

Source Code Files

```
// USB Interrupt Handler
// All Interrupt Sources of the JB8's integrated USB peripheral
// will be treated by this ISR
//
@interrupt void isrUSB() {

    if(UIR1 & BM_EOPF) {                // End of Packet detected?
        SuspendCounter = 0;           // reset 3ms-Suspend Counter
        UIR2 = BM_EOPFR;              // reset EOP Intr Flag
    }
    else if(UIR1 & BM_RXD0F) {          // has EP0 received some data?
        if(USR0 & BM_SETUP)           // was it a SETUP Packet?
            handleSETUP();
    }
    else                                // or a normal OUT Packet
        handleOUT();
    }
    else if(UIR1 & BM_TXD0F) {          // has EP0 sent Data?
        handleIN();
    }
    else if(UIR1 & BM_TXD1F) {          // has EP1 sent Data?
        handleIN1();
    }
    else if(UIR1 & BM_RXD2F) {          // has EP2 received Data?
        handleOUT2();
    }
    else if(UIR1 & BM_RSTF) {          // USB Reset Signal State detected?
        initUSB();                    // Soft Reset of USB Systems
        UCR3 |= BM_ENABLE1+BM_ENABLE2; // Enable EP1 and EP2
        UIR0 = BM_TXD0IE + BM_RXD0IE + // EP0 Rx/Tx Intr Enable and
                BM_TXD1IE + BM_RXD2IE + // EP1 Tx and EP2 Rx Intr Enable
                BM_EOPIE;              // and End-of-Packet Intr Enable
        UCR0 |= BM_RX0E;               // EP0 Receive Enable
        USB_State = US_DEFAULT;        // Device is powered and reset
    }
}

//=====
```

U08232.C

```
//=====
// File: U08232.C
// Func: RS232 Implementation Module for USB08 Demo Application
// Ver.: 1.00
// Auth: (C)2000,2001 by Oliver Thamm, MCT Elektronikladen GbR
//       http://hc08web.de/usb08
// Rem.: View/Edit this File with TAB-Size=4
//=====

//-----
#include "hc08jb8.h"           // HC08JB8 Register Definitions
#include "u08232.h"           // Header File for RS232 Module
//-----

//-----
// Hardware Dependencies - Physical Port Usage for Software SCI Tx/Rx
// Change the following Definitions to meet your Hardware Requirements:
//-----

// Transmit Line is PTC[0]

#define setTxLow()  (PTC &= ~0x01)
#define setTxHigh() (PTC |= 0x01)
#define enaTxOut()  (DDRC |= 0x01)

// Receive Line is PTA[7]

#define tstRxLvl()  (PTA & 0x80)
#define enaRxIn()   (DDRA &= ~0x80)

//-----
// Hardware Dependencies - SSCI Bit Timing generated by System Timer TIM
// Change the following Definitions to meet your Hardware Requirements:
//-----

// clear TSTOP Bit in TSC Register to activate Counter
// PS0..PS2 Prescaler Bits in TSC Register must be 0 (default)
// so the Counter Rate is 3 MHz (0.333µs)

// 9600 Baud -> 104.1666 us per Bit -> 312.5 Clocks per Bit @ 3MHz
// 2400 Baud -> 416.6666 us per Bit -> 1250 Clocks per Bit @ 3MHz
// Adjust Value depending on Subroutine Call Overhead

//-----
```

Source Code Files

```
void delayHalfBit() {
    // subtract ~20 Clocks for Overhead!
    // 120 * 5 Clocks = 600 Clocks
    _asm("\
        lda #120      \n\
__dhbl:deca         \n\
        nop          \n\
        bne __dhbl   \n\
        ");
}

void delayBitTime() {
    delayHalfBit();
    delayHalfBit();
}

//-----

void initSSCI() {
    setTxHigh();           // set Output Data Latch H
    enaTxOut();            // enable Output Driver for Tx
    enaRxIn();             // Rx is an Input Line
}

//-----

void putSSCI(char c) {
    unsigned char n;
    unsigned char ccr_save;

    // ccr_save = getCCR();           // save current Interrupt Mask
    // disableINTR();                // disable Interrupts

    setTxLow();             // send Startbit
    delayBitTime();

    n=8;
    do {                    // send 8 Databits, LSB first
        if((c&1)==0)
            setTxLow();
        else
            setTxHigh();
        delayBitTime();
        c >>= 1;
    } while(--n);

    setTxHigh();           // send Stopbit
    delayBitTime();
    delayBitTime();
    // setCCR(ccr_save);     // restore previous Interrupt Mask
}

```

```
//-----
char getSSCI() {
    char c;
    unsigned char n;
    unsigned char ccr_save;

    // ccr_save = getCCR(); // save current Interrupt Mask
    // disableINTR(); // disable Interrupts

    while(tstRxLvl()!=0) ; // wait for H-L transition
    delayHalfBit();
    n=8;
    do { // get 8 Databits
        delayBitTime();
        c >>= 1;
        if(tstRxLvl()!=0)
            c |= 0x80;
        } while(--n);
    delayBitTime();
    if(tstRxLvl()==0) { // check Rx Line during Stopbit
        // add framing error
        // handling if desired
        }
    delayHalfBit();
    // setCCR(ccr_save); // restore previous Interrupt Mask
    return c;
}

//=====
```

U08KEY.C

```
//=====
// File: U08KEY.C
// Func: Key Input Functions for USB08
// Ver.: 1.00
// Auth: (C)2000,2001 by Oliver Thamm, MCT Elektronikladen GbR
//       http://hc08web.de/usb08
// Rem.: View/Edit this File with TAB-Size=4
//=====

#include "hc08jb8.h"
#include "u08key.h"

//-- Definitions -----

// Specification of *active* Key Inputs:
// PTA[4,5,6] = %01110000 = 0x70
// First Key connected to Port Bit 4

#define KEY_MASK 0x70
#define KEY_FIRST 4

//-- Variables -----

// Var used to track the Key Status

unsigned char KeyState;

//-----

void initKey() {

    POCCR |= 0x01;           // enable PTA Pullups
    PTA    |= KEY_MASK;     // write 1 to Output Latches
    DDRA  |= KEY_MASK;     // output H-Level Pulse
    DDRA  &= ~KEY_MASK;    // back to Input
    KBIER = KEY_MASK;     // enable Interrupts
    KBSCR = 0x04;         // reset ACKK (just in case)
    KeyState = 0;         // reset internal Status Var
}

//-----

char getKey(unsigned char x) {

    x += KEY_FIRST-1;      // calculate Bit Position
    x = 1 << x;           // create Bit Mask
    if(KeyState & x)      // test the relevant Status Bit
        return 1;
    return 0;
}

//-----

@interrupt void isrKey() {

    KeyState ^= ~(PTA | ~KEY_MASK);
    KBSCR = 0x04;         // reset ACKK (for noise safety only)
}

//=====
```

U08ADC.C

```
//=====
// File: U08ADC.C
// Func: Software ADC for USB08
// Ver.: 1.00
// Auth: (C)2000,2001 by Oliver Thamm, MCT Elektronikladen GbR
//       http://hc08web.de/usb08
// Rem.: View/Edit this File with TAB-Size=4
//=====

#include "hc08jb8.h"
#include "u08adc.h"

//-----

void initsADC() {

    // disable internal Pull-Ups on PTE
    POCCR &= ~0x80;// disable PTE20P
}

//-----

unsigned scaleSADC(unsigned t1, unsigned t2) {

    t1 >>= 4;
    t2 <<= 4;
    _asm("lda 5,sp");
    _asm("psha");
    _asm("pulh");
    _asm("ldx 2,sp");
    _asm("lda 6,sp");
    _asm("div");           // A = H:A/X
    _asm("clr");          // 0:A = t2/t1
}

//-----

int getSADC(char channel) {

    unsigned t0, t1, t2;
    unsigned char p;
    unsigned volatile zz;

    // convert channel # 1/2/3 to 0x01/0x02/0x04
    if(channel == 3) channel++;
}
```

Source Code Files

```
// *** calibration cycle ***

PTD &= ~0x78;           // PTD[3..6] = L
DDRDR |= 0x78;          // Output
PTE |= 0x07;           // PTE[0..2] = H;
DDRE |= 0x07;          // Output
for(zz=0;zz<1000;zz--);

DDRE &= ~0x07;          // PTE HiZ (Input)
t0 = TCNT;
while((PTE & channel) != 0);
t1 = TCNT;
t1 -= t0;

// *** acquisition cycle ***

DDRDR &= ~0x38;         // PTD[3..5] = HiZ
DDRE |= 0x07;          // Output
for(zz=0;zz<1000;zz--);

DDRE &= ~0x07;          // PTE HiZ (Input)
t0 = TCNT;
while((PTE & channel) != 0);
t2 = TCNT;
t2 = t2 - t0 - t1 - 100;
if(t2 > 50000u) t2=0;    // underflow
if(t2 >= t1) t2 = t1-1; // overflow

// *** calculate scaled result ***
t2 = scaleSADC(t1,t2);
return t2;
}

//=====
```

VECJB8.C

```
// INTERRUPT VECTORS TABLE FOR HC908JB8
// Cosmic HC08 C Compiler

extern void _stext();          /* startup routine */

extern void isrDummy();
extern void isrUSB();
//extern void timer0ISR();
extern void isrKey();

void (* const _vectab[])() = {
    isrKey,                    /* Keypad          */
    isrDummy,                  /* TIMER overflow  */
    isrDummy,                  /* TIMER channel 1 */
    isrDummy,                  /* TIMER channel 0 */
    isrDummy,                  /* IRQ1            */
    isrUSB,                    /* USB              */
    isrDummy,                  /* SWI              */
    _stext,                    /* RESET           */
};
```

CRTSJB8.S

```
; C STARTUP FOR HC08JB8
; Copyright (c) 1995 by COSMIC Software
;
  xref      __main, __sbss, __memory, __stack, __HC08Setup
  xdef      _exit, __stext
;
__stext:
  ldhx     #__stack           ; initialize stack pointer
  txs
  jsr     __HC08Setup
;
  ldhx     #__sbss           ; start of bss
  bra     loop              ; start loop
zbcl:
  clr     0,x               ; clear byte
  aix     #1                ; next byte
loop:
  cphx     #__memory        ; up to the end
  bne     zbcl              ; and loop
prog:
  ldhx     #__stack         ; initialize stack pointer
  txs
  jsr     _main             ; execute main
_exit:
  bra     _exit             ; and stay here
;
  end
```

USB08.LKF

```
# USB08 LINK COMMAND FILE
# COSMIC HC08 C COMPILER
#
+seg .text -b 0xdc00 -n .text          # program start address
+seg .const -a .text                  # constants follow code
+seg .bsct -b 0x0040 -n .bsct         # zero page start address
+seg .ubsct -a .bsct -n .ubsct        # data start address
+seg .data -a .ubsct                  # data start address
+def __sbss=@.bss                     # start address of bss

# Put your startup file here
crtsjb8.o                              # startup routine

# Put your files here
u08main.o
u08key.o
u08adc.o
#"c:\programs\cosmic\cx08\Lib\libi.h08"
"c:\programs\cosmic\cx08\Lib\libm.h08"

+seg .const -b 0xffff0                # vectors start address
# Put your interrupt vectors file here if needed
vecjb8.o

+def __memory=@.bss                   # symbol used by library
+def __stack=0x013f                   # stack pointer initial value
```

BUILD.BAT

```
cx6808 -v -l u08main.c u08adc.c u08key.c vecjb8.c
clnk -m usb08.map -o usb08.h08 usb08.lkf
chex -fm -h -o usb08.s19 usb08.h08
```

Source Code Files

USB08.MAP

Map of usb08.h08 from link file usb08.lkf - Sun Jan 07 19:29:30 2001

Segments:

```
start 0000dc00 end 0000e263 length 1635 segment .text
start 0000e263 end 0000e2f5 length 146 segment .const
start 00000040 end 00000040 length 0 segment .bsct
start 00000040 end 00000041 length 1 segment .ubsct
start 00000041 end 00000041 length 0 segment .data
start 00000041 end 00000075 length 52 segment .bss
start 0000ffff end 00010000 length 16 segment .const
```

Modules:

```
crtsgb8.o:
start 0000dc00 end 0000dc1d length 29 section .text

u08main.o:
start 0000dc1d end 0000e0e0 length 1219 section .text
start 00000041 end 00000074 length 51 section .bss
start 0000e263 end 0000e2f5 length 146 section .const

u08key.o:
start 0000e0e0 end 0000e133 length 83 section .text
start 00000074 end 00000075 length 1 section .bss

u08adc.o:
start 0000e133 end 0000e263 length 304 section .text

(c:\programme\cosmic\cx08\Lib\libm.h08)ireg.o:
start 00000040 end 00000041 length 1 section .ubsct

vecjb8.o:
start 0000ffff end 00010000 length 16 section .const
```

Stack usage:

```
u08adc.o:
_getSADC          18  (12)
_initSADC         2  (2)
_scaleSADC        6  (6)

u08key.o:
_getKey           4  (4)
_initKey          2  (2)
_isrKey           > 7  (7)

u08main.o:
__HC08Setup      > 2  (2)
_clearFeature     4  (2)
_forceSTALL       2  (2)
```

_getDescriptor	7	(5)
_getUSB	3	(3)
_handleIN	7	(5)
_handleIN1	5	(5)
_handleOUT	2	(2)
_handleOUT2	6	(6)
_handleSETUP	9	(2)
_initUSB	2	(2)
_isrDummy	> 6	(6)
_isrUSB	> 17	(8)
_main	> 33	(15)
_putUSB	5	(5)
_setAddress	4	(2)
_setConfiguration	4	(2)

Symbols:

_ConfigDesc	0000e275	defined in u08main.o section .const
_DeviceDesc	0000e263	defined in u08main.o section .const
_Endpoint1Desc	0000e287	defined in u08main.o section .const *** not used ***
_Endpoint2Desc	0000e28e	defined in u08main.o section .const *** not used ***
_InterfaceDesc	0000e27e	defined in u08main.o section .const *** not used ***
_KeyState	00000074	defined in u08key.o section .bss
_R0Sequence	00000042	defined in u08main.o section .bss
_R2Sequence	00000041	defined in u08main.o section .bss
_RxBuf_RdIdx	00000050	defined in u08main.o section .bss
_RxBuf_WrIdx	0000004f	defined in u08main.o section .bss
_RxBuffer	00000051	defined in u08main.o section .bss
_SetupBuffer	00000046	defined in u08main.o section .bss
_SetupDataPtr	00000043	defined in u08main.o section .bss
_SetupSize	00000045	defined in u08main.o section .bss
_String0Desc	0000e295	defined in u08main.o section .const
_String1Desc	0000e299	defined in u08main.o section .const
_String2Desc	0000e2c1	defined in u08main.o section .const
_StringDescTable	0000e2ef	defined in u08main.o section .const
_SuspendCounter	0000004e	defined in u08main.o section .bss
_TxBuf_RdIdx	00000062	defined in u08main.o section .bss
_TxBuf_WrIdx	00000061	defined in u08main.o section .bss
_TxBuffer	00000063	defined in u08main.o section .bss
_USB_State	00000073	defined in u08main.o section .bss
__HC08Setup	0000dff8	defined in u08main.o section .text used in crtsjb8.o
__memory	00000075	defined in command file section .bss used in crtsjb8.o
__sbss	00000041	defined in command file section .bss used in crtsjb8.o
__stack	0000013f	defined in command file used in crtsjb8.o
__stext	0000dc00	defined in crtsjb8.o section .text used in vecjb8.o
__vectab	0000fff0	defined in vecjb8.o section .const *** not used ***

Source Code Files

<code>_clearFeature</code>	<code>0000dc25</code>	defined in <code>u08main.o</code> section <code>.text</code>
<code>_exit</code>	<code>0000dc1b</code>	defined in <code>crtsjb8.o</code> section <code>.text</code>
<code>_forceSTALL</code>	<code>0000dc1d</code>	defined in <code>u08main.o</code> section <code>.text</code>
<code>_getDescriptor</code>	<code>0000dce1</code>	defined in <code>u08main.o</code> section <code>.text</code>
<code>_getKey</code>	<code>0000e106</code>	defined in <code>u08key.o</code> section <code>.text</code> used in <code>u08main.o</code>
<code>_getSADC</code>	<code>0000e15d</code>	defined in <code>u08adc.o</code> section <code>.text</code> used in <code>u08main.o</code>
<code>_getUSB</code>	<code>0000df5e</code>	defined in <code>u08main.o</code> section <code>.text</code>
<code>_handleIN</code>	<code>0000ddfd</code>	defined in <code>u08main.o</code> section <code>.text</code>
<code>_handleIN1</code>	<code>0000de8d</code>	defined in <code>u08main.o</code> section <code>.text</code>
<code>_handleOUT</code>	<code>0000dde1</code>	defined in <code>u08main.o</code> section <code>.text</code>
<code>_handleOUT2</code>	<code>0000dee0</code>	defined in <code>u08main.o</code> section <code>.text</code>
<code>_handleSETUP</code>	<code>0000dd94</code>	defined in <code>u08main.o</code> section <code>.text</code>
<code>_initKey</code>	<code>0000e0e0</code>	defined in <code>u08key.o</code> section <code>.text</code> used in <code>u08main.o</code>
<code>_initSADC</code>	<code>0000e133</code>	defined in <code>u08adc.o</code> section <code>.text</code> used in <code>u08main.o</code>
<code>_initUSB</code>	<code>0000df2f</code>	defined in <code>u08main.o</code> section <code>.text</code>
<code>_isrDummy</code>	<code>0000dfff</code>	defined in <code>u08main.o</code> section <code>.text</code> used in <code>vecjb8.o</code>
<code>_isrKey</code>	<code>0000e122</code>	defined in <code>u08key.o</code> section <code>.text</code> used in <code>vecjb8.o</code>
<code>_isrUSB</code>	<code>0000df9d</code>	defined in <code>u08main.o</code> section <code>.text</code> used in <code>vecjb8.o</code>
<code>_main</code>	<code>0000e001</code>	defined in <code>u08main.o</code> section <code>.text</code> used in <code>crtsjb8.o</code>
<code>_putUSB</code>	<code>0000df7c</code>	defined in <code>u08main.o</code> section <code>.text</code>
<code>_scaleSADC</code>	<code>0000e13b</code>	defined in <code>u08adc.o</code> section <code>.text</code>
<code>_setAddress</code>	<code>0000dc6e</code>	defined in <code>u08main.o</code> section <code>.text</code>
<code>_setConfiguration</code>	<code>0000dc95</code>	defined in <code>u08main.o</code> section <code>.text</code>
<code>c_reg</code>	<code>00000040</code>	defined in <code>(c:\programme\cosmic\cx08\Lib\libm.h08)</code> <code>ireg.o</code> section <code>.ubsct</code> used in <code>u08main.o</code>

USB08.S19

```
S123DC0045013F94CDDFF845004120037FAF0165007526F845013F94CDE00120FE45001A2F
S123DC20F6AA30F781C60049260FC6004B260AC6004D2605C6004C270220E2C60046A102E9
S123DC4026F7C6004826F2C6004A418104A10226E8A181260945003CF6A43FF7200B4500E4
S123DC6019F6A4BFF74FC70041A6A0B73B81C6004B261BC6004A2616C6004D2611C6004C2D
S123DC80260CC600492607C60048A5802702208DA6A0B73B81C6004B2622C6004A261DC6DE
S123DCA0004D2618C6004C2613C60049260EC60048A1022407C60073A1022603CCDC1DC6DB
S123DCC00048270FA604C70073A620B73CA610B7192009A603C700733F3C3F19A6A0B73B88
S123DCE081A7FDC6004941010B410216410321CDDC1D2033AEE2CF0043A663C70044A6125A
S123DD002022AEE2CF0043A675C70044A6202014CE0048588CD6E2EFC70043DEE2F0CF00D1
S123DD2044878AF6C70045C60049410107410204A103265DC6004CC10045240BC6004D2642
S123DD4006C6004CC70045957FA620E7026F012027C60043CE0044878AF695EE01899EEE66
S123DD60048AF7956C0226026C014500436C0126017C4500457A957CC600452705F6A108FF
S123DD8025CFF6ABA0B73BF6A1082405A6FFC70047A7038145003BF6A4EFF7A601B7188CB0
S123DDA0AE08E61FD700455BF9B63D414805CDDC1D2023C60046A5602705CDDC1D2017C6AA
S123DDC0004741010E41051641061841091ACDDC1D2003CDDC2545003BF6AA10F781CDDC81
S123DDE06E20F3CDDCE120EECD9520E945003BF6A4CFF7A601B718F6AA10F781A7FD4558
S123DE00003BF6A4DFF7A602B718C60047A101277441050F410623A109276A4C276CCDDC10
S123DE201D2067C60048AA80B738C600482704A6032002A602C70073204B957FA620E702FF
S123DE406F012027C60043CE0044878AF695EE01899EEE048AF7956C0226026C01450043A7
S123DE606C0126017C4500457A957CC600452705F6A10825CFB63BA880A480FBAB30B73BAA
S123DE80F6A1082405A6FFC70047A70381A7FD45003CF6A4DFF7A608B718957FA628E702FB
S123DEA06F012021CE00628CD6006395EE01899EEE048AF7C600624CA40FC70062956C0247
S123DEC026026C017CC60062C100612705F6A10825D2B63CA880A480FBAB20B73CA70381FF
S123DEE0A7FC450019F6A4EFF7A610B718A63095E7036F02B63EA40FE7012028C6004F4C1A
S123DF00A40FF7C1005027FB95E602EE03878AF6CE004F8CD7005195F6C7004F6C032602A2
S123DF206C026A016D0126D4A610B719A70481A680B7383F3B3F3C3F19A644B71A3F1B3F34
S123DF4039A6FFB7184FC70042C700414CC700734FC70062C70061C70050C7004F8187C68F
S123DF600050C1004F27F8CE00508CD6005195F7C600504CA40FC70050F68A81878987C637
S123DF8000614CA40F95F7C1006227FBE602CE00618CD7006395F6C70061A703818BB64010
S123DFA0870F3A0A4FC7004EA680B7182045013A0D0D3D05CDDDD94203ACDDDED2035033A6D
S123DFC005CDDDFD202D073A05CDDE8D2025093A05CDDEE0201D0D3A1ACDDDF2F45001AF6E0
S123DFE0AA03F7A69BB73945003BF6AA10F7A602C7007386B7408A80A621B71F3F0A819DB4
S123E00080A7F3CDDF2F450007A607FAF7CDE0E0CDE1339A956F09AF0A9F9EEB0A9724055D
S123E0208B9E6C018A898B95E60B5F4C26015CCDE15D8A88F7956C09E609A10326026F09A3
S123E0404FE7086C08BF40BB409724058B9E6C018A898BCDDF5E8A88F795E608A10825E3D5
S123E0607D2608450003F6AA012006450003F6A4FEF7956D012608450003F6AA0220064585
S123E0800003F6A4FDF7956D022608450003F6AA042006450003F6A4FBF75FA601CDE10619
S123E0A095F75FA602CDE10695E7015FA603CDE10695E702E60AE703E60BE704E60CE705CA
S123E0C04FE7086C08BF40BB409724058B9E6C018AF65FCDDF7C95E608A10825E6CCE01739
S123E0E045001DF6AA01F745000F6AA70F7450004F6AA70F7F6A48FF7A670B717A604B721
S123E100164FC70074818789A60395EB01E701A601EE012703485BFDC400742702A601A7A9
S123E12002818BB600AA8F43450074F8F7A604B7168A8045001DF6A47FF7818789A6049530
S123E1407466014BFAA604680569044BFA9EE605878A9EEE029EE606525FA702818789A78E
S123E160F8A1032603956C09450003F6A487F7450007F6AA78F7450008F6AA07F7450009D8
S123E180F6AA07F79E6F019E6F029EE602A0019EE70224039E6A019EE602A0E89EE601A2AD
S123E1A00325E7F6A4F8F7B60C95E706B60DE707B608E40926FAB60CE704B60DE007E705C0
S123E1C0E604E206E704450007F6A4C7F7450009F6AA07F79E6F019E6F029EE602A0019E0C
S123E1E0E70224039E6A019EE602A0E89EE601A20325E7F6A4F8F7B60C95E706B60DE70740
```

Source Code Files

```
S123E200B608E40926FABE0C9EEF03B60D9EE7049EE008879F95E20797869EE006879F9503
S123E220E2059786A0649EE7049FA20095E702E603A051E602A2C325046F026F03E603E08E
S123E24005E602E204250CE605A001E703E604A200E702E60387E60287E605EE04CDE13B26
S106E260A70C8183
S123E2631201100100000008700C000000010102000109022000010100C0000904000002EE
S123E283FF01FF000705810308000A0705020308000A0403090428034D0043005400200070
S123E2A345006C0065006B00740072006F006E0069006B006C006100640065006E002E030A
S123E2C35500530042003000380020004500760061006C0075006100740069006F006E00AD
S115E2E3200042006F00610072006400E295E299E2C188
S113FFF0E122DFFFDFDFDFDFDFDF9DDFFFD004C
S903FFFFFFE
```

Appendix D. Bill of Materials and Schematic

This appendix includes:

- USB08 V 1.01 bill of materials — [Table D-1](#)
- USB08 evaluation board schematic — [Figure D-1](#)

Table D-1. Bill of Materials for USB08 V 1.01

Part	Value
C1, C2	22 pF
C3, C4, C7, C8, C9, C10, C11, C12, C13, C14, C15, C17, C18, C19	100 nF
C5, C6	10 μ F
C16	100 μ F/25 V
C20, C21, C22	10 nF
D1, D2, D3, D4	LED
D5, D6	BAT42
D7	ZD8.2V
D8	1N4001
IC1	MC68HC908JB8ADW
IC2	MAX232A
IC3	7805
JP1	Header 2x8
JP2	Header 1x3
L1, L2	Ferrite
Q1	XTAL 6 MHz
R1	MPY7P (photoresistor)
R2	K164-4.7k (NTC)
R3	10 k (potentiometer)
R4, R5, R6	10 k
R7	1.5 k/5 % (optional)
R8, R13, R14, R15	10 k
R9	2.2 k
R10, R11, R12, R19	330 R
R16, R17	27 R
R18	10 M
S1, S2, S3, S4, S5	Push Button
X1	Header 2x13
X2, X3	Header 2x5
X4	Power Jack

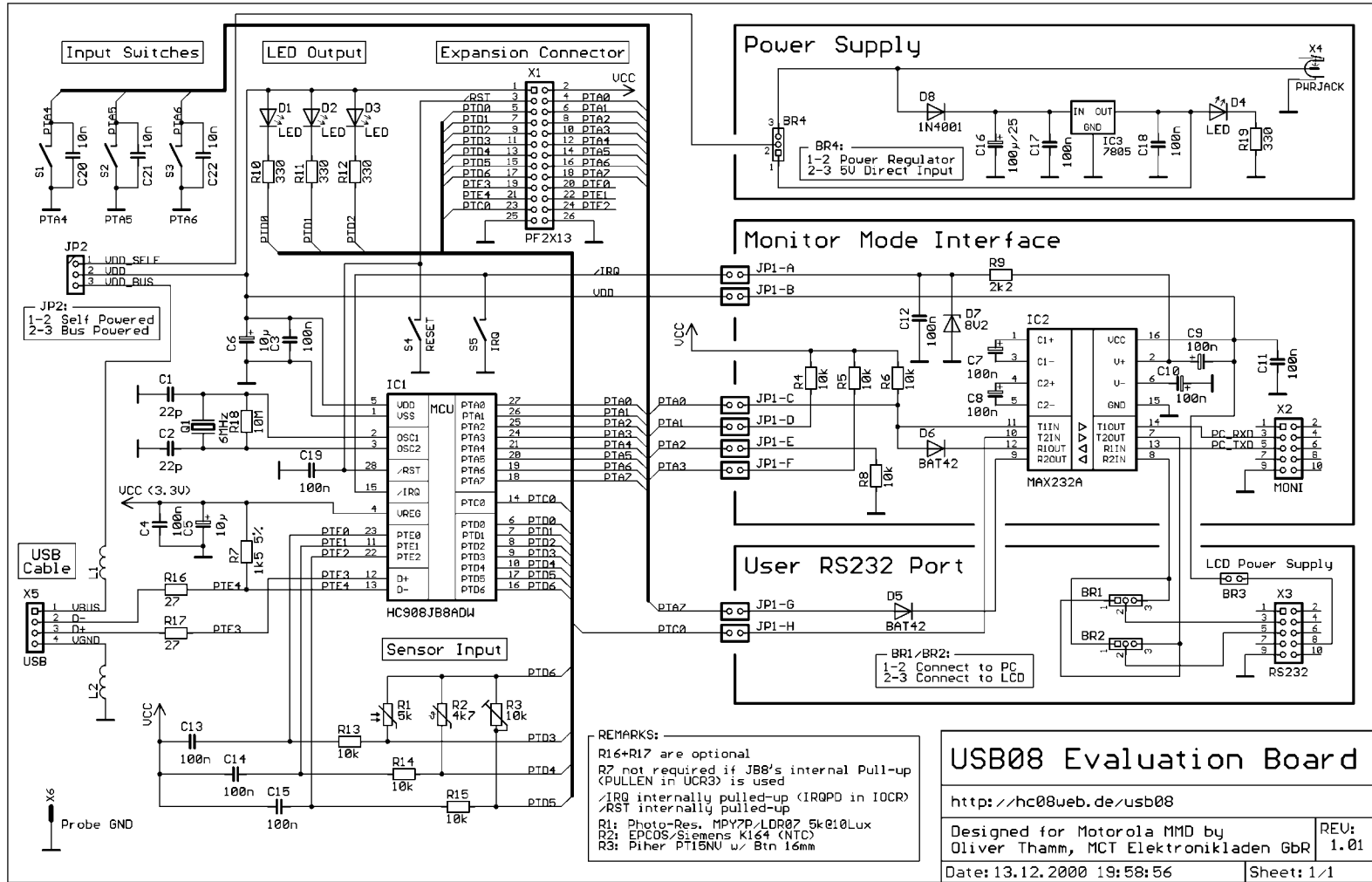

Figure D-1. USB08 Evaluation Board Schematic

Appendix E. Universal USB Device Driver (USBIO)

USBIO

Universal USB Device Driver

for Windows 98, Windows Millennium, and Windows 2000

Reference Manual
Version 1.41
2000, December 20



By: Thesycon® Systemsoftware & Consulting GmbH
Wetzlarer Platz 1
D-98693 Ilmenau
Germany

Telephone: +49 3677 / 8462-0
Fax: +49 3677 / 8462-18
Email: USBIO@thesycon.de
Web: <http://www.thesycon.de>

Copyright © 1998-2000 Thesycon Systemsoftware and Consulting GmbH
All Rights Reserved

Reprinted with permission from Thesycon Systemsoftware & Consulting GmbH. For inclusion in this document, the manual has been reformatted only.

The following trademarks are referenced throughout this manual:
Microsoft, Windows, Win32, Windows NT, and Visual C++ are either trademarks or registered trademarks of Microsoft Corporation.
Other brand and product names are trademarks or registered trademarks of their respective holders.

E.1 Contents

E.2	Introduction	135
E.3	Overview	135
E.3.1	Platforms	136
E.3.2	Features	136
E.4	Architecture	138
E.4.1	USBIO Object Model	140
E.4.1.1	USBIO Device Objects	140
E.4.1.2	USBIO Pipe Objects	142
E.4.2	Establishing a Connection to the Device	144
E.4.3	Power Management	146
E.4.4	Device State Change Notifications	148
E.5	Programming Interface	149
E.5.1	Programming Interface Overview	149
E.5.2	Control Requests	150
	IOCTL_USBIO_GET_DESCRIPTOR	151
	IOCTL_USBIO_SET_DESCRIPTOR	152
	IOCTL_USBIO_SET_FEATURE	153
	IOCTL_USBIO_CLEAR_FEATURE	154
	IOCTL_USBIO_GET_STATUS	155
	IOCTL_USBIO_GET_CONFIGURATION	156
	IOCTL_USBIO_GET_INTERFACE	157
	IOCTL_USBIO_STORE_CONFIG_DESCRIPTOR	158
	IOCTL_USBIO_SET_CONFIGURATION	159
	IOCTL_USBIO_UNCONFIGURE_DEVICE	160
	IOCTL_USBIO_SET_INTERFACE	161
	IOCTL_USBIO_CLASS_OR_VENDOR_IN_REQUEST	162
	IOCTL_USBIO_CLASS_OR_VENDOR_OUT_REQUEST	163
	IOCTL_USBIO_GET_DEVICE_PARAMETERS	164
	IOCTL_USBIO_SET_DEVICE_PARAMETERS	165
	IOCTL_USBIO_GET_CONFIGURATION_INFO	166
	IOCTL_USBIO_RESET_DEVICE	167
	IOCTL_USBIO_GET_CURRENT_FRAME_NUMBER	168
	IOCTL_USBIO_SET_DEVICE_POWER_STATE	169
	IOCTL_USBIO_GET_DEVICE_POWER_STATE	170
	IOCTL_USBIO_GET_DRIVER_INFO	171
	IOCTL_USBIO_CYCLE_PORT	172
	IOCTL_USBIO_BIND_PIPE	174

	IOCTL_USBIO_UNBIND_PIPE	175
	IOCTL_USBIO_RESET_PIPE	176
	IOCTL_USBIO_ABORT_PIPE	177
	IOCTL_USBIO_GET_PIPE_PARAMETERS	178
	IOCTL_USBIO_SET_PIPE_PARAMETERS	179
	IOCTL_USBIO_PIPE_CONTROL_TRANSFER_IN	180
	IOCTL_USBIO_PIPE_CONTROL_TRANSFER_OUT	181
E.5.3	Data Transfer Requests	182
E.5.3.1	Bulk and Interrupt Transfers	182
E.5.3.2	Isochronous Transfers	184
E.5.4	Input and Output Structures	185
	USBIO_DRIVER_INFO	186
	USBIO_DESCRIPTOR_REQUEST	187
	USBIO_FEATURE_REQUEST	188
	USBIO_STATUS_REQUEST	189
	USBIO_STATUS_REQUEST_DATA	190
	USBIO_GET_CONFIGURATION_DATA	191
	USBIO_GET_INTERFACE	192
	USBIO_GET_INTERFACE_DATA	193
	USBIO_INTERFACE_SETTING	194
	USBIO_SET_CONFIGURATION	195
	USBIO_CLASS_OR_VENDOR_REQUEST	196
	USBIO_DEVICE_PARAMETERS	198
	USBIO_INTERFACE_CONFIGURATION_INFO	200
	USBIO_PIPE_CONFIGURATION_INFO	202
	USBIO_CONFIGURATION_INFO	204
	USBIO_FRAME_NUMBER	205
	USBIO_DEVICE_POWER	206
	USBIO_BIND_PIPE	207
	USBIO_PIPE_PARAMETERS	208
	USBIO_PIPE_CONTROL_TRANSFER	209
	USBIO_ISO_TRANSFER	210
	USBIO_ISO_PACKET	212
	USBIO_ISO_TRANSFER_HEADER	213
E.5.5	Enumeration Types	214
	USBIO_PIPE_TYPE	214
	USBIO_REQUEST_RECIPIENT	215
	USBIO_REQUEST_TYPE	216
	USBIO_DEVICE_POWER_STATE	217
E.5.6	Error Codes	218

E.6	USBIO Class Library	220
E.6.1	CUsblo Class	220
E.6.2	CUsbloPipe Class	221
E.6.3	CUsbloThread Class	222
E.6.4	CUsbloReaderClass	222
E.6.5	CUsbloWriter Class	222
E.6.6	CUsbloBufClass	223
E.6.7	CUsbloBufPool Class	223
E.7	USBIO Demo Application	223
E.7.1	Dialog Pages for Device Operations	224
E.7.1.1	Device	224
E.7.1.2	Descriptors	224
E.7.1.3	Configuration	225
E.7.1.4	Interface	225
E.7.1.5	Pipes	225
E.7.1.6	Class or Vendor Request	226
E.7.1.7	Feature	226
E.7.1.8	Other	226
E.7.1.9	Dialog Pages for Pipe Operations	227
E.7.1.10	Pipe	227
E.7.1.11	Buffers	227
E.7.1.12	Control	228
E.7.1.13	Read from Pipe to Output Window	228
E.7.1.14	Read from Pipe to File	228
E.7.1.15	Write from File to Pipe	229
E.8	Installation Issues	229
E.8.1	Automated Installation: The USBIO Installation Wizard	229
E.8.2	Manual Installation: The USBIO Setup Information File	232
E.8.3	Uninstalling USBIO	236
E.8.4	Building a Customized Driver Setup	237
E.9	Registry Entries	239
E.10	Related Documents	241
E.11	Light Version Limitations	241/

E.2 Introduction

USBIO is a generic Universal Serial Bus (USB) device driver for Windows 98, Windows Millennium (ME), and Windows 2000. It is able to control any type of USB device and provides a convenient programming interface that can be used by Win32 applications.

This document describes the architecture, the features, and the programming interface of the USBIO device driver. Furthermore it includes instructions for installing and using the device driver.

The reader of this document is assumed to be familiar with the specification of the Universal Serial Bus and with common aspects of Win32-based application programming.

E.3 Overview

Support for the Universal Serial Bus (USB) is built into the Windows 98, Windows Millennium, and Windows 2000 operating systems. These systems include device drivers for the USB Host Controller hardware, for USB Hubs, and for some classes of USB devices. The USB device drivers provided by Microsoft support devices that conform with the appropriate USB device class definitions made by the USB Implementers Forum. USB devices that do not conform to one of the USB device class specifications, e.g. in the case of a new device class or a device under development, are not supported by device drivers included with the operating system.

In order to use devices that are not supported by the operating system itself the vendor of such a device is required to develop an USB device driver. This driver has to conform to the Win32 Driver Model (WDM) that defines a common driver architecture for Windows 98, Windows Millennium, and Windows 2000. Writing, debugging, and testing of such a driver means considerable effort and requires a lot of knowledge about development of kernel mode drivers.

By using the generic USB device driver USBIO it is possible to get any USB device up and running without spending the time and the effort of developing a device driver. Especially, this might be useful during

development or test of a new device. But in many cases it is also suitable to include the USBIO device driver in the final product. So there is no need to develop and test a custom device driver for the USB-based product at all.

E.3.1 Platforms

The USBIO driver supports the following operating system platforms:

- Windows 98 (Gold), the first release of Windows 98
- Windows 98 Second Edition (SE), the second release of Windows 98
- Windows Millennium, the successor to Windows 98
- Windows 2000, the successor to Windows NT
- Windows 2000 Service Pack 1

NOTE: *Windows NT 4.0 and Windows 95 are not supported by USBIO.*

E.3.2 Features

The USBIO driver provides the following features:

- Compiles with the Win32 Driver Model (WDM)
- Supports Plug&Play
- Supports Power Management
- Provides an interface to USB devices that can be used by any Win32 application
- Provides an interface to USB endpoints (pipes) that is similar to files
- Fully supports asynchronous (overlapped) data transfer operations
- Supports the USB transfer types Control, Interrupt, Bulk, and Isochronous

- Multiple USB devices can be controlled by USBIO at the same time
- Multiple applications can use USBIO at the same time

The USBIO device driver can be used to control any USB device from a Win32 application running in user mode. Examples of such devices are

- telephone and fax devices
- telephone network switches
- audio and video devices (e.g. cameras)
- measuring devices (e.g. oscilloscopes, logic analyzers)
- sensors (e.g. temperature, pressure)
- data converters (e.g. A/D converters, D/A converters)
- bus converters or adapters (e.g. RS 232, IEEE 488)
- chip card devices

If a particular kernel mode interface (e.g. WDM Kernel Mode Streaming, NDIS) has to be supported in order to integrate the device into the operating system, it is not possible to use the generic USBIO driver. However, in such a case it is possible to develop a custom device driver based on the source code of the USBIO though. Please contact Thesycon if you need support on such kind of project.

Although the USBIO device driver fully supports isochronous data pipes, there are some limitations with respect to isochronous data transfers. They result from the fact that the processing of the isochronous data streams has to be performed by the application which runs in user mode. There is no guaranteed response time for threads running in user mode. This may be critical for the implementation of some synchronization methods, for example when the data rate is controlled by loop-back packets (see the USB Specification, Chapter 5 for synchronization issues of isochronous data streams).

However, it is possible to support all kinds of isochronous data streams using the USBIO driver. But the delays that might be caused by the thread scheduler of the operating system should be taken into consideration.

E.4 Architecture

Figure E-1 shows the USB driver stack that is part of the Windows 98, Windows Millennium, and Windows 2000 operating systems. All drivers are embedded within the WDM layered architecture.

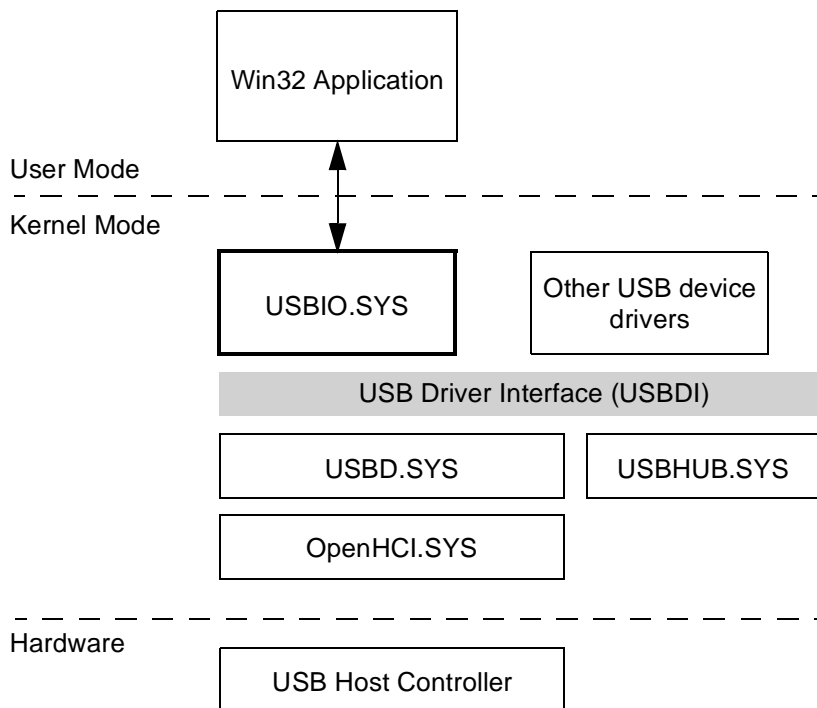

Figure E-1. USB Driver Stack

The following modules are shown in **Figure E-1**:

- USB Host Controller is the hardware component that controls the Universal Serial Bus. It also contains the USB Root Hub.
- OpenHCI.SYS is the host controller driver for controllers that conform with the Open Host Controller Interface specification. Optionally, it can be replaced by UHCD.SYS that is the Universal Host Controller Driver. Which driver is used depends on the main-board chip set for the PC. For instance, Intel chipsets contain an Universal Host Controller.

- USBD.SYS is the USB Bus Driver that controls and manages all devices connected to the USB. It is provided by Microsoft as part of the operating system.
- USBHUB.SYS is the USB Hub Driver. It is responsible for managing and controlling USB Hubs.
- USBIO.SYS is the generic USB device driver USBIO.

The software interface that is provided by the operating system for use by USB device drivers is called USB Driver Interface (USBDI). It is exported by the USBD at the top of the driver stack. USBDI is an IRP-based interface. This means that each individual request is packaged into an I/O request packet (IRP), a data structure that is defined by WDM. The I/O request packets are passed to the next driver in the stack for processing and returned to the caller after completion.

The USB Driver Interface is accessible for kernel mode drivers only. Normally, there is no way to use this interface directly from applications that run in user mode. The USBIO device driver was designed to overcome this limitation. It connects to the USBDI at its lower edge and provides a private interface at its upper edge that can be used by Win32 applications. Thus, the USB driver stack becomes accessible to applications. A Win32 application is able to communicate with one or more USB devices by using the programming interface exported by the USBIO device driver. Furthermore, the USBIO programming interface may be used by more than one application or by multiple instances of one application at the same time.

The main design goal for the USBIO device driver was to make available to applications all the features that the USB driver stack provides at the USBDI level. For that reason the programming interface of the USBIO device driver (USBIOI) is closely related to the USBDI. But many of the functions cannot be translated in an one-to-one relationship.

E.4.1 USBIO Object Model

The USBIO device driver provides a communication model that consists of device objects and pipe objects. The objects are created, destroyed, and managed by the USBIO driver. An application can open handles to device objects and bind these handles to pipe objects.

E.4.1.1 USBIO Device Objects

Each USBIO device object is associated with a physical USB device that is connected to the USB. A device object is created by the USBIO driver in response to an Add Device request from the Plug&Play Manager of the operating system. The USBIO driver is able to handle multiple device objects at the same time.

Each device object created by USBIO is registered with the operating system by using a unique identifier (GUID, Globally Unique Identifier). This identifier is called “Device Interface ID”. All device objects managed by USBIO are identified by the same GUID. The GUID is defined in the USBIO Setup Information (INF) file. Based on the GUID and an instance number, the operating system generates a unique name for each device object. This name should be considered as opaque by applications. It should never be used directly or stored permanently.

It is possible to enumerate all the device objects associated with a particular GUID by using functions provided by the Windows Setup API. The Functions used for this purpose are:

```
SetupDiGetClassDevs()  
SetupDiEnumDeviceInterfaces()  
SetupDiGetDeviceInterfaceDetail()
```

The result of the enumeration process is a list of device objects currently created by USBIO. Each of the USBIO device objects corresponds to a device currently connected to the USB. For each device object an opaque device name string is returned. This string can be passed to `CreateFile()` to open the device object.

A default Device Interface ID (GUID) is built into the USBIO driver. This default ID is defined in USBIO_I.H. Each device object created by USBIO is registered by using this default ID. The default Device

Interface ID is used by the USBIO demo application for device enumeration. This way, it is always possible to access devices connected to the USBIO from the demo application.

In addition, an user-defined Device Interface ID is supported by USBIO. This user-defined GUID is specified in the USBIO INF file by the `USBIO_UserInterfaceGuid` variable. If the user-defined interface ID is present at device initialization time USBIO registers the device with this ID. Thus, two interfaces — default and user-defined — are registered for each device. The default Device Interface ID should only be used by the USBIO demo application. Custom applications should always use a private user-defined Device Interface ID. This way, device naming conflicts are avoided.

IMPORTANT: Every USBIO customer should generate its own private device interface GUID. This is done by using the tool GUIDGEN.EXE from the Microsoft Platform SDK or the VC++ package. This private GUID is specified as user-defined interface in `USBIO_UserInterfaceGuid` in the USBIO INF file. The private GUID is also used by the customer's application for device enumeration. For that reason the generated GUID must also be included in the application. The macro `DEFINE_GUID()` can be used for that purpose. See the Microsoft Platform SDK documentation for further information.

As stated above, all devices connected to USBIO will be associated with the same device interface ID that is also used for device object enumeration. Because of that, the enumeration process will return a list of all USBIO device objects. In order to differentiate the devices an application should query the device descriptor or string descriptors. This way, each device instance can be identified unambiguously.

After the application has received one or more handles for the device, operations can be performed on the device by using a handle. If there is more than one handle to the same device, it makes no difference which handle is used to perform a certain operation. All handles that are associated with the same device behave the same way.

NOTE: *Former versions of USBIO (up to V1.16) used a different device naming scheme. The device name was generated by appending an instance number to a common prefix. So the device names were static. In order*

to ensure compatibility USBIO still supports the old naming scheme. This feature can be enabled by defining a device name prefix in the variable `USBIO_DeviceBaseName` in the USBIO INF file. However, it is strongly recommended to use the new naming scheme based on Device Interface IDs (GUIDs), because it conforms with current Windows 2000 guidelines. The old-style static names should only be used if backward-compatibility with former versions of USBIO is required.

E.4.1.2 USBIO Pipe Objects

The USBIO driver uses pipe objects to represent an active endpoint of the device. The pipe objects are created when the device configuration is set. The number and type of created pipe objects depend on the selected configuration. The USBIO driver does not control the default endpoint (endpoint zero) of a device. This endpoint is owned by the USB bus driver USBD. Because of that, there is no pipe object for endpoint zero and there are no pipe objects available until the device is configured.

In order to access a pipe the application has to create a handle by opening the device object as described above and attach it to a pipe. This operation is called “bind”. After a binding is successfully established the application can use the handle to communicate with the endpoint that the pipe object represents. Each pipe may be bound only once, and a handle may be bound to one pipe only. So there is always an one-to-one relation of pipe handles and pipe objects. This means that the application has to create a separate handle for each pipe it wants to access.

The USBIO driver also supports an “unbind” operation. That is used to delete a binding between a handle and a pipe. After an unbind is performed the handle may be reused to bind another pipe object and the pipe object can be used to establish a binding with another handle.

The following example is intended to explain the relationships described above. In [Figure E-2](#) a configuration is shown where one device object and two associated pipe objects exist within the USBIO data base.

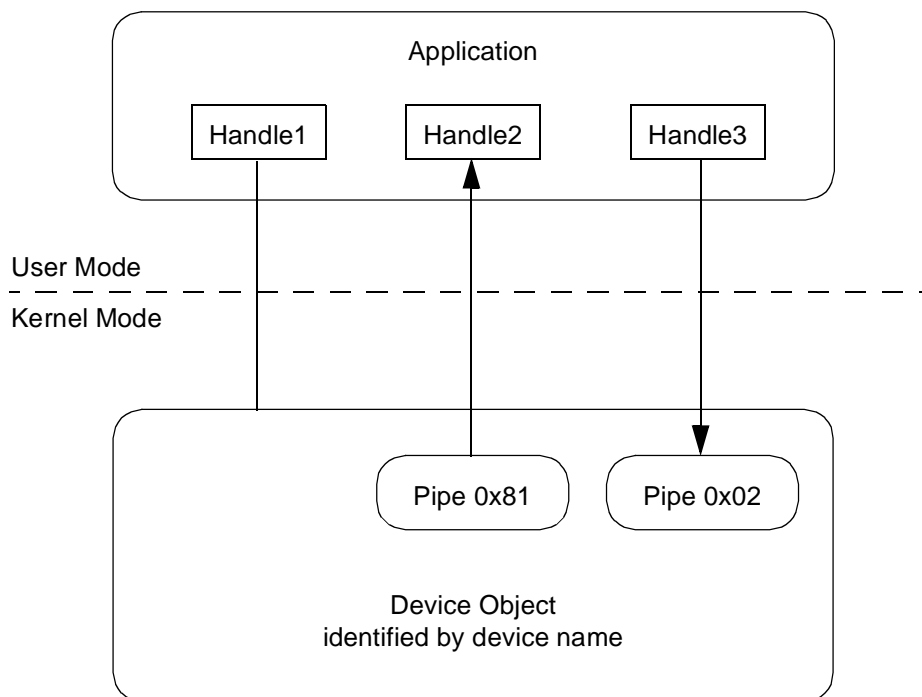

Figure E-2. USBIO Device and Pipe Objects Example

The device object is identified by a device name as described in [E.4.1.1 USBIO Device Objects](#). A pipe object is identified by its endpoint address that also includes the direction flag at bit 7 (MSB). Pipe 0x81 is an IN pipe (transfer direction from device to host) and pipe 0x02 is an OUT pipe (transfer direction from host to device). The application has created three handles for the device by calling `CreateFile()`.

Handle1 is not bound to any pipe, therefore it can be used to perform device-related operations only. It is called a device handle.

Handle2 is bound to the IN pipe 0x81. By using this handle with the Win32 function `ReadFile()` the application can initiate data transfers from endpoint 0x81 to its buffers.

Handle3 is bound to the OUT pipe 0x02. By using Handle3 with the function `WriteFile()` the application can initiate data transfers from its buffers to endpoint 0x02 of the device.

Handle2 and Handle3 are called pipe handles. Note that while Handle1 cannot be used to communicate with a pipe, any operation on the device can be executed by using Handle2 or Handle3, too.

E.4.2 Establishing a Connection to the Device

The following code sample demonstrates the steps that are necessary at the USBIO API to establish a handle for a device and a pipe. The code is not complete, no error handling is included.

```
// include the interface header file of USBIO.SYS
#include "usbio_i.h"

// device instance number
#define DEVICE_NUMBER          0

// some local variables
HANDLE FileHandle;
USBIO_SET_CONFIGURATION SetConfiguration;
USBIO_BIND_PIPE BindPipe;
HDEVINFO DevInfo;
GUID g_UsbioID = USBIO_IID;
SP_DEVICE_INTERFACE_DATA DevData;
SP_INTERFACE_DEVICE_DETAIL_DATA *DevDetail = NULL;
DWORD ReqLen;
DWORD BytesReturned;

// enumerate the devices
// get a handle to the device list
DevInfo = SetupDiGetClassDevs (&g_UsbioID,
                              NULL,NULL,DIGCF_DEVICEINTERFACE|DIGCF_PRESENT);
// get the device with index DEVICE_NUMBER
SetupDiEnumDeviceInterfaces (DevInfo, NULL,
                              &g_UsbioID, DEVICE_NUMBER, &DevData );
// get length of detailed information
SetupDiGetDeviceInterfaceDetail (DevInfo, &DevData, NULL,
                                0, &ReqLen, NULL);

// allocate a buffer
DevDetail = (SP_INTERFACE_DEVICE_DETAIL_DATA*) malloc (ReqLen);
// now get the detailed device information
DevDetail->cbSize = sizeof(SP_INTERFACE_DEVICE_DETAIL_DATA);
SetupDiGetDeviceInterfaceDetail (DevInfo, &DevData, DevDetail,
                                ReqLen, &ReqLen, NULL);

// open the device, use OVERLAPPED flag if necessary
// use DevDetail->DevicePath as device name
FileHandle = CreateFile(
    DevDetail->DevicePath,
    GENERIC_READ|GENERIC_WRITE,
    FILE_SHARE_WRITE|FILE_SHARE_READ,
    NULL,
    OPEN_EXISTING,
    0 /* or FILE_FLAG_OVERLAPPED */,
    NULL);
```



```

// setup the data structure for configuration
// use the configuration descriptor with index 0
SetConfiguration.ConfigurationIndex = 0;
// device has 1 interface
SetConfiguration.NbOfInterfaces = 1;
// first interface is 0
SetConfiguration.InterfaceList[0].InterfaceIndex = 0;
// alternate setting for first interface is 0
SetConfiguration.InterfaceList[0].AlternateSettingIndex = 0;
// maximum buffer size for read/write operation is 4069 bytes
SetConfiguration.InterfaceList[0].MaximumTransferSize = 4096;

// configure the device
DeviceIoControl(FileHandle,
                IOCTL_USBIO_SET_CONFIGURATION,
                &SetConfiguration, sizeof(SetConfiguration),
                NULL, 0,
                &BytesReturned,
                NULL
                );

// setup the data structure to bind the file handle
BindPipe.EndpointAddress = 0x81; // the device has an endpoint 0x81
// bind the file handle
DeviceIoControl(FileHandle,
                IOCTL_USBIO_BIND_PIPE
                &BindPipe, sizeof(BindPipe),
                NULL, 0,
                &BytesReturned,
                NULL
                );

// read (or write) data from (to) the device
// use OVERLAPPED structure if necessary
ReadFile(FileHandle, ...);

// close file handle
CloseHandle(FileHandle);

```

Refer to the Win32 API documentation for the syntax and the parameters of the functions **SetupDiXXX**, **CreateFile**, **DeviceIoControl**, **ReadFile**, **WriteFile**, **CloseHandle**. The file handle can be opened with the **FILE_FLAG_OVERLAPPED** flag if asynchronous behaviour is required.

More code samples that show the usage of the USBIO programming interface can be found in the USBIO Class Library (USBIO LIB), the USBIO demo application (USBIO APP), and the simple console applications **ReaderCpp** and **ReadPipe**.

E.4.3 Power Management

Windows 98, Windows Millennium, and Windows 2000 support system power management. That means that if the computer is idle for a given time, some parts of the computer can go into a sleeping mode. A system power change can be initiated by the user or by the operating system itself, on a low battery condition for example. An USB device driver has to support the system power management. Each device which supports power switching has to have a device power policy owner. It is responsible for managing the device power states in response to system power state changes. The USBIO driver is the power policy owner of the USB devices that it controls. In addition to the system power changes the device power policy owner can initiate device power state changes.

Before the system goes into a sleep state the operating system asks every driver if its device can go into the sleep state. If all active drivers return success the system goes down. Otherwise, a message box appears on the screen and informs the user that the system is not able to go into the sleeping mode.

Before the system goes into a sleeping state the driver has to save all the information that it needs to reinitialize the device (device context) if the system is resumed. Furthermore, all pending requests have to be completed and further requests have to be queued. In the device power states D1 or D2 (USB Suspend) the device context stored in the USB device will be lost. Therefore, a device sleeping state D1 or D2 is handled transparent for the application. In the state D3 (USB Off) the device context is lost. Because the information stored in the device is known to the application only (e.g. the current volume level of an audio device), the generic USBIO driver cannot restore the device context in a general way. This has to be done by the application. Note that Windows 2000 restores the USB configuration of the device (SET_CONFIGURATION request) after the system is resumed.

The behaviour with respect to power management can be customized by registry parameters. For example, if a long time measurement should be performed the computer has to be prevented from going power down. For a description of the supported registry parameters, see [E.9 Registry Entries](#).

All registry entries describing device power states are DWORD parameters where the value 0 corresponds to **DevicePowerD0**, 1 to **DevicePowerD1**, and so on.

The parameter **PowerStateOnOpen** specifies the power state to which the device is set if the first file handle is opened. If the last file handle is closed the USB device is set to the power state specified in the entry **PowerStateOnClose**.

If at least one file handle is open for the device the key **MinPowerStateUsed** describes the minimal device power state that is required. If the value is set to 0 the computer will never go into a sleep state. If this key is set to 2 the device can go into a suspend state but not into D3 (Off). A power-down request caused by a low battery condition cannot be suppressed by using this parameter.

If no file handle is currently open for the device, the key **MinPowerStateUnused** defines the minimal power state the device can go into. Thus, its meaning is similar to that of the parameter **MinPowerStateUsed**.

If the parameter **AbortPipesOnPowerDown** is set to 1 all pending requests submitted by the application are returned before the device enters a sleeping state. This switch should be set to 1 if the parameter **MinPowerStateUsed** is different from D0. The pending I/O requests are returned with the error code **USBIO_ERR_POWER_DOWN**. This signals to the application that the error was caused by a power down event. The application may ignore this error and repeat the request. The re-submitted requests will be queued by the USBIO driver. They will be executed after the device is back in state D0.

E.4.4 Device State Change Notifications

The application is able to receive notifications when the state of an USB device changes. The Win32 API provides the function `RegisterDeviceNotification` for this purpose. This way, an application will be notified if an USB device is plugged in or removed.

Please refer to the Microsoft Platform SDK documentation for detailed information on the functions `RegisterDeviceNotification` and `UnregisteredDeviceNotification`. In addition, the source code of the USBIO demo application USBIOAPP provides an usage example.

The device notification mechanism is only available if the USBIO device naming scheme is based on Device Interface IDs (GUIDs). See [E.4.1.1 USBIO Device Objects](#) for details. We strongly recommend to use this new naming scheme.

NOTE: *The function `UnregisteredDeviceNotification` should not be used on Windows 98. There is a bug in the implementation that causes the system to become unstable. So it may crash at some later point in time. The bug seems to be “well known”, it was discussed in some Usenet groups.*

E.5 Programming Interface

E.5.1 Programming Interface Overview

Table E-1. I/O Operations Supported by the USBIO Device Driver

Operation	Used On	Bus Action
IOCTL_USBIO_GET_DRIVER_INFO	device	—
IOCTL_USBIO_GET_DESCRIPTOR	device	request on default pipe
IOCTL_USBIO_SET_DESCRIPTOR	device	request on default pipe
IOCTL_USBIO_SET_FEATURE	device	request on default pipe
IOCTL_USBIO_CLEAR_FEATURE	device	request on default pipe
IOCTL_USBIO_GET_STATUS	device	request on default pipe
IOCTL_USBIO_GET_CONFIGURATION	device	request on default pipe
IOCTL_USBIO_GET_INTERFACE	device	request on default pipe
IOCTL_USBIO_STORE_CONFIG_DESCRIPTOR	device	—
IOCTL_USBIO_SET_CONFIGURATION	device	request on default pipe
IOCTL_USBIO_UNCONFIGURE_DEVICE	device	request on default pipe
IOCTL_USBIO_SET_INTERFACE	device	request on default pipe
IOCTL_USBIO_CLASS_OR_VENDOR_IN_REQUEST	device	request on default pipe
IOCTL_USBIO_CLASS_OR_VENDOR_OUT_REQUEST	device	request on default pipe
IOCTL_USBIO_GET_DEVICE_PARAMETERS	device	—
IOCTL_USBIO_SET_DEVICE_PARAMETERS	device	—
IOCTL_USBIO_GET_CONFIGURATION_INFO	device	—
IOCTL_USBIO_RESET_DEVICE	device	reset on hub port, USB D assigns USB address
IOCTL_USBIO_GET_CURRENT_FRAME_NUMBER	device	—
IOCTL_USBIO_GET_DEVICE_POWER_STATE	device	—
IOCTL_USBIO_SET_DEVICE_POWER_STATE	device	set properties on hub port
IOCTL_USBIO_BIND_PIPE	device	—
IOCTL_USBIO_UNBIND_PIPE	pipe	—
IOCTL_USBIO_RESET_PIPE	pipe	request on default pipe
IOCTL_USBIO_ABORT_PIPE	pipe	—
IOCTL_USBIO_GET_PIPE_PARAMETERS	pipe	—
IOCTL_USBIO_SET_PIPE_PARAMETERS	pipe	—
IOCTL_USBIO_PIPE_CONTROL_TRANSFER_IN	pipe	request on pipe
IOCTL_USBIO_PIPE_CONTROL_TRANSFER_OUT	pipe	request on pipe
ReadFile	pipe	data transfer from pipe (IN)
WriteFile	pipe	data transfer to pipe (OUT)

E.5.2 Control Requests

This section provides a detailed description of the I/O Control operations the USBIO driver supports through its programming interface. The I/O Control requests are submitted to the driver using the Win32 function `DeviceIoControl` (see [E.4 Architecture](#)). The `DeviceIoControl` function is defined as follows:

```
BOOL DeviceIoControl (  
    HANDLE hDevice,           // handle to device of interest  
    DWORD dwIoControlCode,   // control code of operation to perform  
    LPVOID lpInBuffer,       // pointer to buffer to supply input data  
    DWORD nInBufferSize,    // size of input buffer  
    LPVOID lpOutBuffer,     // pointer to buffer to receive output data  
    DWORD nOutBufferSize,   // size of output buffer  
    LPDWORD lpBytesReturned, // pointer to variable to receive  
                                // output byte count  
    LPOVERLAPPED lpOverlapped // pointer to overlapped structure  
                                // for asynchronous operation  
);
```

Refer to the Microsoft Platform SDK documentation for more information.

The following sections describe the I/O Control codes that may be passed to the `DeviceIoControl` function as `dwIoControlCode` and the parameters required for `lpInBuffer`, `nInBufferSize`, `lpOutBuffer`, `nOutBufferSize`.

IOCTL_USBIO_GET_DESCRIPTOR

The IOCTL_USBIO_GET_DESCRIPTOR operation requests a specific descriptor from the device.

lpInBuffer	Pointer to a buffer that contains an USBIO_DESCRIPTOR_REQUEST (page 187) data structure. This data structure has to be filled completely by the caller.
nInBufferSize	Specifies the size, in bytes, of the buffer pointed to by lpInBuffer , which has to be sizeof(USBIO_DESCRIPTOR_REQUEST) for this operation.
lpOutBuffer	Pointer to a buffer that will receive the descriptor data.
nOutBufferSize	Specifies the size in bytes, of the buffer pointed to be lpOutBuffer .
<i>Comments</i>	The buffer that is passed to this function in lpOutBuffer should be large enough to hold the requested descriptor, otherwise only a part of the descriptor will be returned. The size of the output buffer should be a multiple of the packet size of the default pipe (endpoint zero).

IOCTL_USBIO_SET_DESCRIPTOR

The IOCTL_USBIO_SET_DESCRIPTOR operation sets a specific descriptor of the device.

lpInBuffer	Pointer to a buffer that contains an USBIO_DESCRIPTOR_REQUEST (page 187) data structure. This data structure has to be filled completely by the caller.
nInBufferSize	Specifies the size, in bytes, of the buffer pointed to by lpInBuffer , which has to be sizeof(USBIO_DESCRIPTOR_REQUEST) for this operation.
lpOutBuffer	Pointer to a buffer that contains the descriptor data to be set.
nOutBufferSize	Specifies the size, in bytes, of the buffer pointed to by lpOutBuffer .
<i>Comments</i>	USB devices do not have to support this operation.

IOCTL_USBIO_SET_FEATURE

The IOCTL_USBIO_SET_FEATURE operation is used to set or enable a specific feature.

lpInBuffer Pointer to a buffer that contains an **USBIO_FEATURE_REQUEST** (page 188) data structure. This data structure has to be filled completely by the caller.

nInBufferSize Specifies the size, in bytes, of the buffer pointed to by **lpInBuffer**, which has to be sizeof(USBIO_FEATURE_REQUEST) for this operation.

lpOutBuffer Not used with this operation. Set to NULL.

nOutBufferSize Not used with this operation. Set to zero.

Comments The SET_FEATURE request appears on the bus with the parameters specified in the IOCTL_USBIO_SET_FEATURE structure.

IOCTL_USBIO_CLEAR_FEATURE

The IOCTL_USBIO_CLEAR_FEATURE operation is used to clear or disable a specific feature.

lpInBuffer Pointer to a buffer that contains an **USBIO_FEATURE_REQUEST** (page 188) data structure. This data structure has to be filled completely by the caller.

nInBufferSize Specifies the size, in bytes, of the buffer pointed to by **lpInBuffer**, which has to be sizeof(USBIO_FEATURE_REQUEST) for this operation.

lpOutBuffer Not used with this operation. Set to NULL.

nOutBufferSize Not used with this operation. Set to zero.

Comments The CLEAR_FEATURE request appears on the bus with the parameters specified in the IOCTL_USBIO_CLEAR_FEATURE structure.

IOCTL_USBIO_GET_STATUS

The IOCTL_USBIO_GET_STATUS operation requests status for a specific recipient.

lpInBuffer	Pointer to a buffer that contains an USBIO_STATUS_REQUEST (page 189) data structure. This data structure has to be filled completely by the caller.
nInBufferSize	Specifies the size, in bytes, of the buffer pointed to by lpInBuffer , which has to be sizeof(USBIO_STATUS_REQUEST) for this operation.
lpOutBuffer	Pointer to a buffer that will receive an USBIO_STATUS_REQUEST_DATA (page 190) data structure.
nOutBufferSize	Specifies the size, in bytes, of the buffer pointed to by lpOutBuffer , which has to be at least sizeof(USBIO_STATUS_REQUEST_DATA) for this operation.
<i>Comments</i>	The GET_STATUS request appears on the bus with the parameters specified in the USBIO_STATUS_REQUEST (page 189) structure. The function returns the structure USBIO_STATUS_REQUEST_DATA (page 190) which contains two bytes of data.

IOCTL_USBIO_GET_CONFIGURATION

The IOCTL_USBIO_GET_CONFIGURATION operation returns the current configuration of the device.

lpInBuffer	Not used with this operation. Set to NULL.
nInBufferSize	Not used with this operation. Set to zero.
lpOutBuffer	Pointer to a buffer that will receive an USBIO_GET_CONFIGURATION_DATA (page 191) data structure.
nOutBufferSize	Specifies the size, in bytes, of the buffer pointed to by lpOutBuffer , which has to be at least <code>sizeof(USBIO_GET_CONFIGURATION_DATA)</code> for this operation.
<i>Comments</i>	A GET_CONFIGURATION request appears on the bus. The structure USBIO_GET_CONFIGURATION_DATA (page 191) returns the configuration value. A value of zero means “not configured”.

IOCTL_USBIO_GET_INTERFACE

The IOCTL_USBIO_GET_INTERFACE operation returns the current alternate setting of a specific interface.

lpInBuffer	Pointer to a buffer that contains an USBIO_GET_INTERFACE (page 192) data structure. This data structure has to be filled completely by the caller.
nInBufferSize	Specifies the size, in bytes, of the buffer pointed to by lpInBuffer , which has to be sizeof(USBIO_GET_INTERFACE) for this operation.
lpOutBuffer	Pointer to a buffer that will receive an USBIO_GET_INTERFACE_DATA (page 193) data structure.
nOutBufferSize	Specifies the size, in bytes, of the buffer pointed to by lpOutBuffer , which has to be at least sizeof(USBIO_GET_INTERFACE_DATA) for this operation.
<i>Comments</i>	A GET_INTERFACE request appears on the bus. The structure USBIO_GET_INTERFACE_DATA (page 193) returns the current alternate setting of the interface specified in USBIO_GET_INTERFACE.

IOCTL_USBIO_STORE_CONFIG_DESCRIPTOR

The IOCTL_USBIO_STORE_CONFIG_DESCRIPTOR operation stores the configuration descriptor to be used for set configuration requests within the USBIO device driver.

lpInBuffer	Pointer to a buffer that contains the configuration descriptor data.
nInBufferSize	Specifies the size, in bytes, of the buffer pointed to by lpInBuffer .
lpOutBuffer	Not used with this operation. Set to NULL.
nOutBufferSize	Not used with this operation. Set to zero
<i>Comments</i>	This request may be used to store an user-defined configuration descriptor within the USBIO driver. The stored descriptor is used by the USBIO driver in subsequent IOCTL_USBIO_SET_CONFIGURATION (page 159) operations. The usage of IOCTL_USBIO_STORE_CONFIG_DESCRIPTOR is optional. If no user-defined configuration descriptor is stored, USBIO uses the descriptor from the device.

There may be cases where the USBBD driver provided by Microsoft with Windows does not process correctly the configuration descriptor that is reported by the device. This means it would not be possible to configure the device. In this situation the

IOCTL_USBIO_STORE_CONFIG_DESCRIPTOR request may be used to work around the problem. This request enables the application to use a modified configuration descriptor. The application can get the configuration descriptor using **ISOCTL_USBIO_GET_DESCRIPTOR** (page 151), modify it appropriately and store it in the USBIO driver using the **IOCTL_USBIO_STORE_CONFIG_DESCRIPTOR** request. Thus, the modified configuration descriptor will be passed to USBBD when the device is configured.

The following is an example for the problem described above:

In the endpoint descriptor of an audio device the **bmAttributes** field contains two additional bits of information as defined by the audio class specification. The USBBD does not recognize the pipe correctly and returns an invalid pipe type, when the additional bits in **bmAttributes** are not masked off. This has to be done by the application.

IOCTL_USBIO_SET_CONFIGURATION

The IOCTL_USBIO_SET_CONFIGURATION operation is used to set the device configuration.

lpInBuffer	Pointer to a buffer that contains an USBIO_SET_CONFIGURATION (page 195) data structure. This data structure has to be filled completely by the caller.
nInBufferSize	Specifies the size, in bytes, of the buffer pointed to by lpInBuffer , which has to be sizeof(USBIO_SET_CONFIGURATION) for this operation.
lpOutBuffer	Not used with this operation. Set to NULL.
nOutBufferSize	Not used with this operation. Set to zero.
<i>Comments</i>	A SET_CONFIGURATION request appears on the bus. The USB D generates additional SET_INTERFACE requests on the bus if necessary.

All available interfaces have to be configured, or the request will fail. The number of interfaces and the alternate setting for each interface have to be specified in the structure **USBIO_SET_CONFIGURATION** (page 195).

All pipe handles associated with the device will be unbound and all pending requests will be cancelled. If this request returns with success, new pipe objects are available. The operation **IOCTL_USBIO_GET_CONFIGURATION_INFO** (page 166) may be used to query all available pipes and interfaces.

By default, the configuration descriptor that is reported by the device is passed to the USB D. If an user-defined configuration descriptor is stored with **IOCTL_USBIO_STORE_CONFIG_DESCRIPTOR** (page 158), this descriptor is used.

IOCTL_USBIO_UNCONFIGURE_DEVICE

The IOCTL_USBIO_UNCONFIGURE_DEVICE operation is used to set the device to its unconfigured state.

lpInBuffer	Not used with this operation. Set to NULL.
nInBufferSize	Not used with this operation. Set to zero.
lpOutBuffer	Not used with this operation. Set to NULL.
nOutBufferSize	Not used with this operation. Set to zero.
<i>Comments</i>	A SET_CONFIGURATION request with the configuration value 0 appears on the bus. All pipe handles associated with the device will be unbound and all pending requests will be cancelled.

IOCTL_USBIO_SET_INTERFACE

The IOCTL_USBIO_SET_INTERFACE operation sets the alternate setting of a specific interface.

lpInBuffer	Pointer to a buffer that contains an USBIO_INTERFACE_SETTING (page 194) data structure. This data structure has to be filled completely by the caller.
nInBufferSize	Specifies the size, in bytes, of the buffer pointed to by lpInBuffer , which has to be sizeof(USBIO_INTERFACE_SETTING) for this operation.
lpOutBuffer	Not used with this operation. Set to NULL.
nOutBufferSize	Not used with this operation. Set to zero.
<i>Comments</i>	A SET_INTERFACE request appears on the bus.

All pipe handles associated with the interface will be unbound and all pending requests will be cancelled. If this request returns with success, new pipe objects are available. The operation IOCTL_USBIO_GET_CONFIGURATION_INFO (page 166) may be used to query all available pipes and interfaces.

IOCTL_USBIO_CLASS_OR_VENDOR_IN_REQUEST

The IOCTL_USBIO_CLASS_OR_VENDOR_IN_REQUEST operation is used to generate a class or vendor specific device request with a data transfer direction from device to host.

lpInBuffer	Pointer to a buffer that contains an USBIO_CLASS_OR_VENDOR_REQUEST (page 196) data structure. This data structure has to be filled completely by the caller.
nInBufferSize	Specifies the size, in bytes, of the buffer pointed to by lpInBuffer , which has to be sizeof(USBIO_CLASS_OR_VENDOR_REQUEST) for this operation.
lpOutBuffer	Pointer to a buffer that receives the data transferred from the device during the data phase of the control transfer. If the request does not return any data, this value can be NULL.
nOutBufferSize	Specifies the size, in bytes, of the buffer pointed to by lpOutBuffer . If this value is set to zero then there is no data transfer phase.
<i>Comments</i>	A SETUP request appears on the default pipe (endpoint zero) of the USB device with the given parameters. If a data phase is required an IN token appears on the bus and the successful transfer is acknowledged by an OUT token with a zero length data packet. If no data phase is required an IN token appears on the bus with a zero length data packet from the USB device for acknowledge.

IOCTL_USBIO_CLASS_OR_VENDOR_OUT_REQUEST

The IOCTL_USBIO_CLASS_OR_VENDOR_OUT_REQUEST operation is used to generate a class or vendor specific device request with a data transfer direction from host to device.

lpInBuffer	Pointer to a buffer that contains an USBIO_CLASS_OR_VENDOR_REQUEST (page 196) data structure. This data structure has to be filled completely by the caller.
nInBufferSize	Specifies the size, in bytes, of the buffer pointed to by lpInBuffer , which has to be sizeof(USBIO_CLASS_OR_VENDOR_REQUEST) for this operation.
lpOutBuffer	Pointer to a buffer that contains the data to be transferred to the device during the data phase of the control transfer. If the request has no data phase this value can be NULL.
nOutBufferSize	Specifies the size, in bytes, of the buffer pointed to by lpOutBuffer . If this value is set to zero then there is no data transfer phase.
<i>Comments</i>	A SETUP request appears on the default pipe (endpoint zero) of the USB device with the given parameters. If a data phase is required an OUT token appears on the bus and the successful transfer is acknowledged by an IN token with a zero length data packet from the device. If no data phase is required an IN token appears on the bus and the device acknowledges with a zero length data packet.

IOCTL_USBIO_GET_DEVICE_PARAMETERS

The IOCTL_USBIO_GET_DEVICE_PARAMETERS operation returns USBIO settings related to a device.

lpInBuffer	Not used with this operation. Set to NULL.
nInBufferSize	Not used with this operation. Set to zero.
lpOutBuffer	Pointer to a buffer that will receive an USBIO_DEVICE_PARAMETERS (page 198) data structure.
nOutBufferSize	Specifies the size, in bytes, of the buffer pointed to by lpOutBuffer , which has to be at least <code>sizeof(USBIO_DEVICE_PARAMETERS)</code> for this operation.
<i>Comments</i>	The default state of the device parameters is defined by a set of registry parameters which are read by the USBIO driver at startup. The current state may be queried using this request.

IOCTL_USBIO_SET_DEVICE_PARAMETERS

The IOCTL_USBIO_SET_DEVICE_PARAMETERS operation is used to set USBIO parameters related to a device.

lpInBuffer	Pointer to a buffer that contains an USBIO_DEVICE_PARAMETERS (page 198) data structure. This data structure has to be filled completely by the caller.
nInBufferSize	Specifies the size, in bytes, of the buffer pointed to be lpInBuffer , which has to be sizeof(USBIO_DEVICE_PARAMETERS) for this operation.
lpOutBuffer	Not used with this operation. Set to NULL.
nOutBufferSize	Not used with this operation. Set to zero.
<i>Comments</i>	The default state of the device parameters is defined by a set of registry parameters which are read by the USBIO driver at startup. The current state may be modified using this request.

IOCTL_USBIO_GET_CONFIGURATION_INFO

The IOCTL_USBIO_GET_CONFIGURATION_INFO operation returns information about the pipes and interfaces that are available after the device is configured.

lpInBuffer	Not used with this operation. Set to NULL.
nInBufferSize	Not used with this operation. Set to zero.
lpOutBuffer	Pointer to a buffer that will receive an USBIO_CONFIGURATION_INFO (page 204) data structure.
nOutBufferSize	Specifies the size, in bytes, of the buffer pointed to by lpOutBuffer , which has to be at least <code>sizeof(USBIO_CONFIGURATION_INFO)</code> for this operation.
<i>Comments</i>	This operation returns information about all active pipes and interfaces that are available in the current configuration.

IOCTL_USBIO_RESET_DEVICE

The IOCTL_USBIO_RESET_DEVICE operation causes a reset at the hub port in which the device is plugged in.

lpInBuffer	Not used with this operation. Set to NULL.
nInBufferSize	Not used with this operation. Set to zero.
lpOutBuffer	Not used with this operation. Set to NULL.
nOutBufferSize	Not used with this operation. Set to zero.

Comments The following events occur on the bus if this request is issued:

- USB Reset
- GET_DEVICE_DESCRIPTOR
- USB Reset
- SET_ADDRESS
- GET_DEVICE_DESCRIPTOR
- GET_CONFIGURATION_DESCRIPTOR

All pipes associated with the device will be unbound and all pending requests will be cancelled. Note that the device receives two USB Resets and a new USB address is assigned by USBD. After this operation the device is in the unconfigured state.

The USBIO driver allows an USB reset request only if the device is configured. That means **IOCTL_USBIO_SET_CONFIGURATION** ([page 159](#)) was successfully executed. If the device is in the unconfigured state this request returns with an error status. This limitation is caused by the behaviour of Windows 2000. A system crash would occur on Windows 2000 if an USB Reset would be issued for an unconfigured device. Therefore, USBIO does not allow to issue an USB Reset while the device is configured.

If the device changes its USB descriptor set during an USB Reset the **IOCTL_USBIO_CYCLE_PORT** ([page 172](#)) request should be used instead of IOCTL_USBIO_RESET_DEVICE.

This request does not work if the system-provided multi-interface driver is used.

IOCTL_USBIO_GET_CURRENT_FRAME_NUMBER

The IOCTL_USBIO_GET_CURRENT_FRAME_NUMBER operation returns the current value of the frame number counter that is maintained by the USBD.

lpInBuffer	Not used with this operation. Set to Null.
nInBufferSize	Not used with this operation. Set to zero.
lpOutBuffer	Pointer to a buffer that will receive an USBIO_FRAME_NUMBER (page 205) data structure.
nOutBufferSize	Specifies the size, in bytes, of the buffer pointed to by lpOutBuffer , which has to be at least <code>sizeof(USBIO_FRAME_NUMBER)</code> for this operation.
<i>Comments</i>	The returned frame number is a 32 bit value. The lower 11 bits of this value correspond to the frame number value in the Start Of Frame token on the bus.

IOCTL_USBIO_SET_DEVICE_POWER_STATE

The IOCTL_USBIO_SET_DEVICE_POWER_STATE operation sets the power state of the device.

lpInBuffer Pointer to a buffer that contains an **USBIO_DEVICE_POWER** (page 206) data structure.

nInBufferSize Specifies the size, in bytes, of the buffer pointed to by **lpInBuffer**, which has to be at least sizeof(USBIO_DEVICE_POWER) for this operation.

lpOutBuffer Not used with this operation. Set to NULL.

nOutBufferSize Not used with this operation. Set to zero.

Comments The device power state is maintained internally by the USBIO driver. This request may be used to change the current power state.

If the device is set to a power state different from D0 all pending requests should be cancelled before.

See Also See **E.4.3 Power Management** (page 146) and the description of the data structure **USBIO_DEVICE_POWER** (page 206) for details.

IOCTL_USBIO_GET_DEVICE_POWER_STATE

The IOCTL_USBIO_GET_DEVICE_POWER_STATE operation returns the current power state of the device.

lpInBuffer Not used with this operation. Set to NULL.

nInBufferSize Not used with this operation. Set to zero.

lpOutBuffer Pointer to a buffer that will receive an **USBIO_DEVICE_POWER** (page 206) data structure.

nOutBufferSize Specifies the size, in bytes, of the buffer pointed to by **lpOutBuffer**, which has to be at least `sizeof(USBIO_DEVICE_POWER)` for this operation.

Comments The device power state is maintained internally by the USBIO driver. This request may be used to query the current power state.

IOCTL_USBIO_GET_DRIVER_INFO

The IOCTL_USBIO_GET_DRIVER_INFO operation returns version information about the USBIO API and the driver binary that is currently running.

lpInBuffer	Not used with this operation. Set to NULL.
nInBufferSize	Not used with this operation. Set to zero.
lpOutBuffer	Pointer to a buffer that will receive an USBIO_DRIVER_INFO (page 186) data structure.
nOutBufferSize	Specifies the size, in bytes, of the buffer pointed to by lpOutBuffer , which has to be at least <code>sizeof(USBIO_DRIVER_INFO)</code> for this operation.
<i>Comments</i>	An application should check if the API version of the driver that is currently running matches with the version it expects.

IOCTL_USBIO_CYCLE_PORT

The IOCTL_USBIO_CYCLE_PORT operation causes a new enumeration of the device.

lpInBuffer Not used with this operation. Set to NULL.

nInBufferSize Not used with this operation. Set to zero.

lpOutBuffer Not used with this operation. Set to NULL.

nOutBufferSize Not used with this operation. Set to zero.

Comments The IOCTL_USBIO_CYCLE_PORT request is similar to the **IOCTL_USBIO_RESET_DEVICE** (page 167) request, except that from the software point of view a disconnect/connect is simulated. This request causes the following events to occur:

- The USBIO device instance that is associated with the USB device will be removed. The corresponding device handles become invalid and should be closed by the application.
- The operating system starts a new enumeration of the device. The following events occur on the bus:
 - USB Reset
 - GET_DEVICE_DESCRIPTOR
 - USB Reset
 - SET_ADDRESS
 - GET_DEVICE_DESCRIPTOR
 - GET_CONFIGURATION_DESCRIPTOR
- A new device instance is created by the USBIO driver.
- The application receives a PnP notification that informs it about the new device instance.

After an application issued this request it should close all handles for the current device. It can open the newly created device instance after it receives the appropriate PnP notification.

This request should be used instead of **IOCTL_USBIO_RESET_DEVICE** ([page 167](#)) if the USB device modifies its descriptors during an USB Reset. Particularly, this is required to implement the Device Firmware Upgrade (DFU) device class specification. Note that the USB device receives two USB Resets after this call. This does not conform to the DFU specification. However, this is the standard device enumeration method used by the Windows USB bus driver (USBBD).

This request does not work if the system-provided multi-interface driver is used. This driver expects that all function device drivers send a CYCLE_PORT request within 5 seconds.

IOCTL_USBIO_BIND_PIPE

The IOCTL_USBIO_BIND_PIPE operation is used to establish a binding between a file handle and a pipe object.

lpInBuffer Pointer to a buffer that contains an USBIO_BIND_PIPE ([page 207](#)) data structure. This data structure has to be filled completely by the caller.

nInBufferSize Specifies the size, in bytes, of the buffer pointed to by **lpInBuffer**, which has to be sizeof(USBIO__BIND_PIPE) for this operation.

lpOutBuffer Not used with this operation. Set to NULL.

nOutBufferSize Not used with this operation. Set to zero.

Comments This pipe is identified by its endpoint address. Only endpoints from the current configuration can be bound. After this operation is successfully completed the pipe can be accessed using pipe related requests (e.g. read or write).

See Also **IOCTL_USBIO_SET_CONFIGURATION** ([page 159](#)) and **IOCTL_USBIO_GET_CONFIGURATION_INFO** ([page 166](#))

IOCTL_USBIO_UNBIND_PIPE

The IOCTL_USBIO_UNBIND_PIPE operation deletes the binding between a file handle and a pipe object.

lpInBuffer Not used with this operation. Set to NULL.

nInBufferSize Not used with this operation. Set to zero.

lpOutBuffer Not used with this operation. Set to NULL.

nOutBufferSize Not used with this operation. Set to zero.

Comments After this operation is successfully completed the handle is unbound and may be used to bind another pipe. It is not necessary to unbind a pipe handle before it is closed. Closing a handle unbinds it implicitly.

IOCTL_USBIO_RESET_PIPE

The IOCTL_USBIO_RESET_PIPE operation clears an error condition on a pipe.

lpInBuffer Not used with this operation. Set to NULL.

nInBufferSize Not used with this operation. Set to zero.

lpOutBuffer Not used with this operation. Set to NULL.

nOutBufferSize Not used with this operation. Set to zero.

Comments If an error occurs while transferring data from or to a pipe the USB D halts the pipe and returns an error code. No further transfers can be performed while the pipe is halted. To recover from this error condition and to restart the pipe an **IOCTL_USBIO_RESET_PIPE** has to be sent to the pipe.

This request causes that a CLEAR_FEATURE(ENDPOINT_STALL) request appears on the bus. In addition, the endpoint handling in the USB host controller will be reinitialized.

Isochronous pipes will never be halted by the USB D. This is because on isochronous pipes no handshake is used to detect errors in data transmission.

IOCTL_USBIO_ABORT_PIPE

The IOCTL_USBIO_ABORT_PIPE operation causes that all outstanding requests for the pipe are cancelled.

lpInBuffer	Not used with this operation. Set to NULL.
nInBufferSize	Not used with this operation. Set to zero.
lpOutBuffer	Not used with this operation. Set to NULL.
nOutBufferSize	Not used with this operation. Set to zero.
<i>Comments</i>	All outstanding read or write requests on the pipe are aborted and returned with an error status of USBIO_ERR_CANCELLED .

IOCTL_USBIO_GET_PIPE_PARAMETERS

The IOCTL_USBIO_GET_PIPE_PARAMETERS operation returns USBIO settings related to a pipe.

lpInBuffer	Not used with this operation. Set to NULL.
nInBufferSize	Not used with this operation. Set to zero.
lpOutBuffer	Pointer to a buffer that will receive an USBIO_PIPE_PARAMETERS (page 208) data structure.
nOutBufferSize	Specifies the size, in bytes, of the buffer pointed to by lpOutBuffer , which has to be at least <code>sizeof(USBIO_PIPE_PARAMETERS)</code> for this operation.
<i>Comments</i>	The default state of the pipe parameters is defined by a set of registry parameters which are read by the USBIO driver at startup. The current state can be queried by using this request.

IOCTL_USBIO_SET_PIPE_PARAMETERS

The IOCTL_USBIO_SET_PIPE_PARAMETERS operation is used to set USBIO parameters related to a pipe.

lpInBuffer	Pointer to a buffer that contains an USBIO_PIPE_PARAMETERS (page 208) data structure. This data structure has to be filled completely by the caller.
nInBufferSize	Specifies the size, in bytes, of the buffer pointed to by lpInBuffer , which has to be sizeof(USBIO_PIPE_PARAMETERS) for this operation.
lpOutBuffer	Not used with this operation. Set to NULL.
nOutBufferSize	Not used with this operation. Set to zero.
<i>Comments</i>	The default state of the pipe parameters is defined by a set of registry parameters which are read by the USBIO driver at startup. The current state can be modified by using this request.

IOCTL_USBIO_PIPE_CONTROL_TRANSFER_IN

The IOCTL_USBIO_PIPE_CONTROL_TRANSFER_IN operation is used to generate a specific request (setup packet) for a control pipe with a data transfer direction from device to host.

lpInBuffer	Pointer to a buffer that contains an USBIO_PIPE_CONTROL_TRANSFER (page 209) data structure. This data structure has to be filled completely by the caller.
nInBufferSize	Specifies the size, in bytes, of the buffer pointed to by lpInBuffer , which has to be sizeof(USBIO_PIPE_CONTROL_TRANSFER) for this operation.
lpOutBuffer	Pointer to a buffer that receives the data transferred from the device during the data phase of the control transfer. If no data transfer is required the pointer may be NULL.
nOutBufferSize	Specifies the size, in bytes, of the buffer pointed to by lpOutBuffer . If this value is set to zero then there is no data transfer phase.
<i>Comments</i>	This request is intended to be used with additional control pipes a device might provide. It is not possible to generate a control transfer for the default endpoint zero with this operation.

IOCTL_USBIO_PIPE_CONTROL_TRANSFER_OUT

The IOCTL_USBIO_PIPE_CONTROL_TRANSFER_OUT operation is used to generate a specific request (setup packet) for a control pipe with a data transfer direction from host to device.

lpInBuffer	Pointer to a buffer that contains an USBIO_PIPE_CONTROL_TRANSFER (page 209) data structure. This data structure has to be filled completely by the caller.
nInBufferSize	Specifies the size, in bytes, of the buffer pointed to by lpInBuffer , which has to be sizeof(USBIO_PIPE_CONTROL_TRANSFER) for this operation.
lpOutBuffer	Pointer to a buffer that contains the data transferred to the device during the data phase of the control transfer. If no data transfer is required the pointer may be NULL.
nOutBufferSize	Specifies the size, in bytes, of the buffer pointed to by lpOutBuffer . If this value is set to zero then there is no data transfer phase.
<i>Comments</i>	This request is intended to be used with additional control pipes a device might provide. It is not possible to generate a control transfer for the default endpoint zero with this operation.

E.5.3 Data Transfer Requests

The USBIO device driver exports an interface to USB pipes that is similar to files. For that reason the Win32 API functions **ReadFile** and **WriteFile** are used to transfer data from or to a pipe. The handle that is associated with the USB pipe is passed as **hFile** to this function.

The **ReadFile** function is defined as follows:

```
BOOL ReadFile (  
    HANDLE hFile,                // handle of file to read  
    LPVOID lpBuffer,            // pointer to buffer that receives data  
    DWORD nNumberOfBytesToRead, // number of bytes to read  
    LPDWORD lpNumberOfBytesRead, // pointer to number of bytes read  
    LPOVERLAPPED lpOverlapped   // pointer to OVERLAPPED structure  
);
```

The **WriteFile** function is defined as follows:

```
BOOL WriteFile (  
    HANDLE hFile,                // handle of file to write  
    LPVOID lpBuffer,            // pointer to data to write to file  
    DWORD nNumberOfBytesToWrite, // number of bytes to write  
    LPDWORD lpNumberOfBytesWritten, // pointer to number of bytes written  
    LPOVERLAPPED lpOverlapped   // pointer to OVERLAPPED structure  
);
```

By using these functions it is possible to implement both synchronous and asynchronous data transfer operations. Both methods are fully supported by the USBIO driver. Refer to the Microsoft Platform SDK documentation for more information on using the **ReadFile** and **WriteFile** functions.

E.5.3.1 Bulk and Interrupt Transfers

For interrupt and bulk transfers the buffer size can be larger than the maximum packet size of the endpoint (physical FIFO size) as reported in the endpoint descriptor. But the buffer size has to be equal or smaller than the value specified in the **MaximumTransferSize** field of the **USBIO_INTERFACE_SETTING** (page 194) structure on the Set Configuration call.

Bulk or Interrupt Write Transfers

The write operation is used to transfer data from the host (PC) to the USB device. The buffer is divided into data pieces (packets) of the FIFO size of the endpoint. These packets are sent to the USB device. If the last packet of the buffer is smaller than the FIFO size a smaller data packet is transferred. If the size of the last packet of the buffer is equal to the FIFO size this packet is sent. No additional zero packet is sent automatically. To send a data packet with length zero, set the buffer length to zero and use a NULL buffer pointer.

Bulk or Interrupt Read Transfers

The read operation is used to transfer data from the USB device to the host (PC). The buffer is divided into data pieces (packets) of the FIFO size of the endpoint. The buffer size should be a multiple of the FIFO size. Otherwise the last transaction can cause a buffer overflow error.

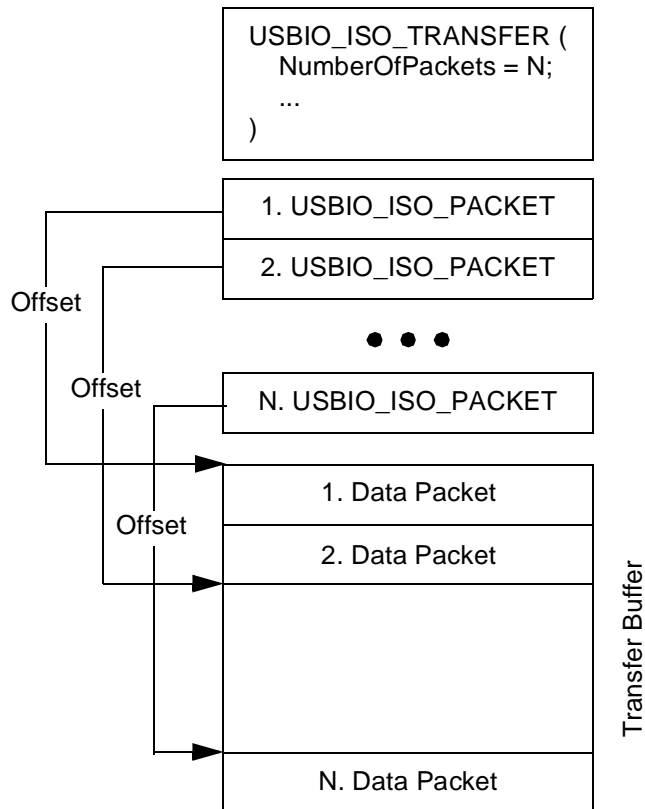

Figure E-3. Layout of an Isochronous Transfer Buffer

A read operation will be completed if the whole buffer is filled or a short packet is transmitted. A short packet is a packet that is shorter than the FIFO size of the endpoint. For more information on receiving short packets see below. To read a data packet with a length of zero, the buffer size has to be at least one byte. A read operation with a NULL buffer will be completed with success by the system without performing a read operation of the USB.

The behavior of the read operation depends on the state of the flag `USBIO_SHORT_TRANSFER_OK` of the related pipe. This setting may be changed by using the `IOCTL_USBIO_SET_PIPE_PARAMETERS` (page 179) operation. The default state is defined by the registry parameter `ShortTransferOk`. If the flag `USBIO_SHORT_TRANSFER_OK` is set a read operation that returns a data packet that is shorter than the FIFO size of the endpoint is completed with success. Otherwise, every data packet from the endpoint that is smaller than the FIFO size causes an error.

E.5.3.2 Isochronous Transfers

For isochronous transfers the data buffer that is passed to the `ReadFile` or `WriteFile` function has to contain a header that describes the location and the size of the data packets to be transferred. Therefore, the buffer that follows the header is divided into packets. Each packet is transmitted within an USB frame (normally 1 ms). The size of the packet can be different in each frame. This allows to support any data rate of the isochronous data stream.

The structure of the data buffer is shown in [Figure E-3](#). The buffer contains an `USBIO_ISO_TRANSFER_HEADER` (page 213) structure of variable size at offset zero and the data packets. The header contains an `USBIO_ISO_TRANSFER` (page 210) structure that provides general information about the transfer buffer. An important member of this structure is the `NumberOfPackets` parameter. This parameter specifies the number of data packets contained in the transfer buffer. The maximum number of packets that can be used in a single transfer is limited by the registry parameter `MaxIsoPackets`. Each data packet has to be described by an `USBIO_ISO_PACKET` (page 212) structure

in the header. Because of that, the header contains a variable size array of **USBIO_ISO_PACKET** (page 212) elements.

The Offset member of the **USBIO_ISO_PACKET** structure specifies the byte offset of the corresponding packet relative to the beginning of the whole buffer and has to be filled by the application for write and for read transfers. The Length member defines the length, in bytes, of the packet. The packet length has to be specified by the application for write transfers and is returned by the USBIO on read transfers. The Status member is used to return the completion status of the transfer of the packet.

Isochronous Write Transfers

The sizes of the packets have to be less than or equal to the FIFO size of the endpoint. There must not be gaps between the data packets in the transfer buffer. The Offset and Length member of the **USBIO_ISO_PACKET** structures have to be initialized correctly before the transfer is started.

Isochronous Read Transfers

The size of each packet should be equal to the FIFO size. Otherwise a data overrun error can occur. The Offset member of the **USBIO_ISO_PACKET** structures has to be initialized correctly before the transfer is started. There must not be gaps between the data packets in the transfer buffer. The length of each received data packet is returned in the Length member of the corresponding **USBIO_ISO_PACKET** structure when the transfer completes.

NOTE: *Because the size of the received packets may be less than the FIFO size the data packets are not arranged continuously within the transfer buffer.*

E.5.4 Input and Output Structures

This section provides a detailed description of the data structures that are used with the various input and output requests.

USBIO_DRIVER_INFO

The USBIO_DRIVER_INFO structure contains version information about the driver binary and the programming interface.

Definition

```
typedef struct _USBIO_DRIVER_INFO{
    USHORT APIVersion;
    USHORT DriverVersion;
    ULONG DriverBuildNumber;
    ULONG Flags;
} USBIO_DRIVER_INFO;
```

Members **APIVersion**

Contains the version number of the application programming interface (API) the driver supports.

The format is as follows: upper 8 bit = major version, lower 8 bit = minor version. The numbers are encoded in BCD format.

DriverVersion

Contains the version number of the driver executable.

The format is as follows: upper 8 bit = major version, lower 8-bit = minor version.

DriverBuildNumber

Contains the build number of the driver executable.

Flags

This field contains zero or any combination (bit-wise or) of the following values.

USBIO_INFOFLAG_CHECKED_BUILD

If this flag is set, the driver that is currently running is a checked (debug) build.

USBIO_INFOFLAG_DEMO_VERSION

If this flag is set, the driver that is currently running is a DEMO version that has some restrictions. Refer to ReadMe.txt for a description of the restrictions.

USBIO_INFOFLAG_LIGHT_VERSION

If this flag is set, the driver that is currently running is a LIGHT version that has some restrictions. Refer to ReadMe.txt for a description of the restrictions.

Comments This structure is an output of the **IOCTL_USBIO_GET_DRIVER_INFO** (page 171) operation.

USBIO_DESCRIPTOR_REQUEST

The USBIO_DESCRIPTOR_REQUEST structure provides information used to get or set a descriptor.

Definition

```
typedef struct _USBIO_DESCRIPTOR_REQUEST{
    USBIO_REQUEST_RECIPIENT Recipient;
    UCHAR DescriptorType;
    UCHAR DescriptorIndex;
    USHORT LanguageId;
} USBIO_DESCRIPTOR_REQUEST;
```

Members **Recipient**
Specifies the recipient of the get or set descriptor request. The values are defined by the enumeration type **USBIO_REQUEST_RECIPIENT** ([page 215](#)).

DescriptorType
Specifies the type of descriptor to get or set. The values are defined by the Universal Serial Bus Specification 1.1, Chapter 9 and additional device class specifications.

Value	Meaning
1	Device Descriptor
2	Configuration Descriptor
3	String Descriptor
4	Interface Descriptor
5	Endpoint Descriptor
21	HID Descriptor

DescriptorIndex
Specifies the index of the descriptor to get or set.

LanguageId
Specifies the Language ID for string descriptors. Set to zero for other descriptors.

Comments This structure has to be used as an input for **IOCTL_USBIO_GET_DESCRIPTOR** ([page 151](#)) and **IOCTL_USB_SET_DESCRIPTOR** ([page 152](#)) requests.

USBIO_FEATURE_REQUEST

The USBIO_FEATURE_REQUEST structure provides information used to set or clear a specific feature.

Definition `typedef struct _USBIO_FEATURE_REQUEST{
 USBIO_REQUEST_RECIPIENT Recipient;
 USHORT FeatureSelector;
 USHORT Index;
 } USBIO_FEATURE_REQUEST;`

Members **Recipient**
 Specifies the recipient of the set feature or clear feature request. The values are defined by the enumeration type **USBIO_REQUEST_RECIPIENT** ([page 215](#)).

FeatureSelector
 Specifies the feature selector value for the set feature or clear feature request. The values are defined by the recipient. Refer to the Universal Serial Bus Specification 1.1, Chapter 9 for more information.

Index
 Specifies the index value for the set feature or clear feature request. The values are defined by the device. Refer to the Universal Serial Bus Specification 1.1, Chapter 9 for more information.

Comments This structure has to be used as an input for **IOCTL_USBIO_SET_FEATURE** ([page 153](#)) and **IOCTL_USBIO_CLEAR_FEATURE** ([page 154](#)) requests.

USBIO_STATUS_REQUEST

The USBIO_STATUS_REQUEST structure provides information used to request status for a specified recipient.

Definition `typedef struct _USBIO_STATUS_REQUEST {
 USBIO_REQUEST_RECIPIENT Recipient;
 USHORT Index;
 } USBIO_STATUS_REQUEST;`

Members **Recipient**
 Specifies the recipient of the get status request. The values are defined by the enumeration type **USBIO_REQUEST_RECIPIENT** ([page 215](#)).

Index
 Specifies the index value for the get status request. The values are defined by the device. Refer to the Universal Serial Bus Specification 1.1, Chapter 9 for more information.

Comments This structure has to be used as an input for **IOCTL_USBIO_GET_STATUS** ([page 155](#)) requests.

USBIO_STATUS_REQUEST_DATA

The USBIO_STATUS_REQUEST_DATA structure contains information returned by a get status operation.

Definition `typedef struct _USBIO_STATUS_REQUEST_DATA {
 USHORT Status;
 } USBIO_STATUS_REQUEST_DATA;`

Member **Status**
 Contains the 16-bit value that is returned by the recipient in response to the get status request. The interpretation of the value is specific to the recipient. Refer to the Universal Serial Bus Specification 1.1, Chapter 9 for more information.

Comments This structure is an output of **IOCTL_USBIO_GET_STATUS** ([page 155](#)) requests.

USBIO_GET_CONFIGURATION_DATA

The USBIO_GET_CONFIGURATION_DATA structure contains information returned by a get configuration operation.

Definition `typedef struct _USBIO_GET_CONFIGURATION_DATA{
 UCHAR ConfigurationValue;
 } USBIO_GET_CONFIGURATION_DATA;`

Member **ConfigurationValue**
 Contains the 8-bit value that is returned by the device in response to the get configuration request. The meaning of the value is defined by the device. A value of zero means the device is not configured. Refer to the Universal Serial Bus Specification 1.1, Chapter 9 for more information.

Comments This structure is an output of **IOCTL_USBIO_GET_CONFIGURATION** (page 156) requests.

USBIO_GET_INTERFACE

The USBIO_GET_INTERFACE structure provides information used to request the current alternate setting of an interface.

Definition `typedef struct _USBIO_GET_INTERFACE{
 USHORT Interface;
 } USBIO_GET_INTERFACE;`

Member **Interface**
 Specifies the interface number. The meaning is device-specific. Refer to the Universal Serial Bus Specification 1.1, Chapter 9 for more information.

Comments This structure has to be used as an input for **IOCTL_USBIO_GET_INTERFACE** ([page 157](#)) requests.

USBIO_GET_INTERFACE_DATA

The USBIO_GET_INTERFACE_DATA structure contains information returned by a get interface operation.

Definition `typedef struct _USBIO_GET_INTERFACE_DATA{
 UCHAR AlternateSetting;
 } USBIO_GET_INTERFACE_DATA;`

Member **AlternateSetting**
 Contains the 8-bit value that is returned by the device in response to a get interface request. The interpretation of the value is specific to the device. Refer to the Universal Serial Bus Specification 1.1, Chapter 9 for more information.

Comments This structure is an output of **IOCTL_USBIO_GET_INTERFACE** (page 157) requests.

USBIO_INTERFACE_SETTING

The USBIO_INTERFACE_SETTING structure provides information used to configure an interface and its endpoints.

Definition `typedef struct _USBIO_INTERFACE_SETTING{
 USHORT InterfaceIndex;
 USHORT AlternateSettingIndex;
 ULONG MaximumTransferSize;
 } USBIO_INTERFACE_SETTING;`

Members **InterfaceIndex**

Specifies the interface. The value is defined by the device. Refer to the Universal Serial Bus Specification 1.1, Chapter 9 for more information.

AlternateSettingIndex

Specifies the alternate setting to be set for this interface. The value is defined by the device. Refer to the Universal Serial Bus Specification 1.1, Chapter 9 for more information.

MaximumTransferSize

Specifies the maximum size, in bytes, of data transfers to or from endpoints of this interface. The value is user-defined and is valid for all endpoints of this interface. If no special requirement exists a value of 4096 (4K) should be used.

Comments This structure has to be used as an input for **IOCTL_USBIO_SET_INTERFACE** ([page 161](#)) and **IOCTL_USBIO_SET_CONFIGURATION** ([page 159](#)) requests.

USBIO_SET_CONFIGURATION

The USBIO_SET_CONFIGURATION structure provides information used to set the device configuration.

Definition

```
typedef struct _USBIO_SET_CONFIGURATION{
    USHORT ConfigurationIndex;
    USHORT NbOfInterfaces;
    USBIO_INTERFACE_SETTING
        InterfaceList[USBIO_MAX_INTERFACES];
} USBIO_SET_CONFIGURATION;
```

Members **ConfigurationIndex**
Specifies the configuration to be set. The meaning of the value is defined by the device. Refer to the Universal Serial Bus Specification 1.1, Chapter 9 for more information.

NbOfInterface
Specifies the number of interfaces in this configuration. This is the number of valid entries in InterfaceList.

InterfaceList [USBIO_MAX_INTERFACES]
An array of **USBIO_INTERFACE_SETTING** (page 194) structures that describes each interface in the configuration. There have to be NbOfInterfaces valid entries in this array.

Comments This structure has to be used as an input for **IOCTL_USBIO_SET_CONFIGURATION** (page 159) requests.

USBIO_CLASS_OR_VENDOR_REQUEST

The USBIO_CLASS_OR_VENDOR_REQUEST structure provides information used to generate a class or vendor specific device request.

Definition

```
typedef struct _USBIO_CLASS_OR_VENDOR_REQUEST{
    ULONG Flags;
    USBIO_REQUEST_TYPE Type;
    USBIO_REQUEST_RECIPIENT Recipient;
    UCHAR RequestTypeReservedBits;
    UCHAR Request;
    USHORT Value;
    USHORT Index;
} USBIO_CLASS_OR_VENDOR_REQUEST;
```

Members

Flags

This field contains zero or the following value.

USBIO_SHORT_TRANSFER_OK

If this flag is set, the USBIO driver does not return an error if a data packet received from the device is shorter than the maximum packet size of the endpoint. Otherwise, a short packet causes an error condition.

Type

Specifies the type of the device request. The values are defined by the enumeration type **USBIO_REQUEST_TYPE** ([page 216](#)).

Recipient

Specifies the recipient of the device request. The values are defined by the enumeration type **USBIO_REQUEST_RECIPIENT** ([page 215](#)).

RequestTypeReservedBits

Specifies the reserved bits of the **bmRequestType** field of the setup packet.

Request

Specifies the value of the **bRequest** field of the setup packet.

Value

Specifies the value of the **wValue** field of the setup packet.

Index

Specifies the value of the **wIndex** field of the setup packet.

Comments The values defined by this structure are used to generate an eight byte setup packet for the control endpoint of the device. The format of the setup packet is defined by the Universal Serial Bus Specification 1.1, Chapter 9. The meanings of the values are device dependent.

This structure has to be used as an input for **IOCTL_USBIO_CLASS_OR_VENDOR_IN_REQUEST** ([page 162](#)) and **IOCTL_USBIO_CLASS_OR_VENDOR_OUT_REQUEST** ([page 163](#)) operations.

USBIO_DEVICE_PARAMETERS

The USBIO_DEVICE_PARAMETERS structure contains device-specific parameter settings of the USBIO driver.

Definition

```
typedef struct _USBIO_DEVICE_PARAMETERS{
    ULONG Options;
    ULONG RequestTimeout;
} USBIO_DEVICE_PARAMETERS;
```

Members **Options**

This field contains zero or any combination (bit-wise or) of the following values.

USBIO_RESET_DEVICE_ON_CLOSE

If this option is set, the USBIO driver generates an USB device reset after the last handle to the device was closed by the application. When this option is active the **USBIO_UNCONFIGURE_ON_CLOSE** flag will be ignored.

The default state of this option is defined by the registry parameter **ResetDeviceOnClose**.

USBIO_UNCONFIGURE_ON_CLOSE

If this option is set, the USBIO driver sets the USB device to its unconfigured state after the last handle to the device was closed by the application.

The default state of this option is defined by the registry parameter **UnconfigureOnClose**.

USBIO_ENABLE_REMOTE_WAKEUP

If this option is set and the USB device supports the Remote Wakeup feature the USBIO driver will support Remote Wakeup for the operating system. The USB device is able to wake the system from a sleep state. The Remote Wakeup feature is defined by the USB 1.1 specification.

The Remote Wakeup feature requires that the device is opened by an application and an USB configuration is set (device is configured).

The default state of this option is defined by the registry parameter **EnableRemoteWakeup**.

RequestTimeout

Specifies the time-out interval, in milliseconds, to be used for synchronous operations. A value of zero means an infinite interval (time-out disabled).

The default time-out value is defined by the registry parameter **RequestTimeout**.

Comments This structure is intended to be used with **IOCTL_USBIO_GET_DEVICE_PARAMETERS** ([page 164](#)) and **IOCTL_USBIO_SET_DEVICE_PARAMETERS** ([page 165](#)) operations.

USBIO_INTERFACE_CONFIGURATION_INFO

The USBIO_INTERFACE_CONFIGURATION_INFO structure provides information about an interface.

Definition

```
typedef struct _USBIO_INTERFACE_CONFIGURATION_INFO{
    UCHAR InterfaceNumber ;
    UCHAR AlternateSetting ;
    UCHAR Class ;
    UCHAR SubClass ;
    UCHAR Protocol ;
    UCHAR NumberOfPipes ;
    UCHAR reserved1 ;
    UCHAR reserved2 ;
} USBIO_INTERFACE_CONFIGURATION_INFO ;
```

Members **InterfaceNumber**

Specifies the index of the interface as reported by the device in the configuration descriptor.

AlternateSetting

Specifies the index of the alternate setting as reported by the device in the configuration descriptor. The default alternate setting of an interface is zero.

Class

Specifies the class code as reported by the device in the configuration descriptor. The meaning of this value is defined by the USB class specifications.

SubClass

Specifies the subclass code as reported by the device in the configuration descriptor. The meaning of this value is defined by the USB class specifications.

Protocol

Specifies the protocol code as reported by the device in the configuration descriptor. The meaning of this value is defined by the USB class specifications.

NumberOfPipes

Specifies the number of pipes that belong to this interface and alternate setting.

reserved1
Reserved field, set to zero.

reserved2
Reserved field, set to zero.

Comments This structure is an output of
IOCTL_USBIO_GET_CONFIGURATION_INFO ([page 166](#)) operations.

USBIO_PIPE_CONFIGURATION_INFO

The USBIO_PIPE_CONFIGURATION_INFO structure provides information about a pipe.

Definition

```
typedef struct _USBIO_PIPE_CONFIGURATION_INFO{
    USBIO_PIPE_TYPE PipeType;
    ULONG MaximumTransferSize;
    USHORT MaximumPacketSize;
    UCHAR EndpointAddress;
    UCHAR Interval;
    UCHAR InterfaceNumber;
    UCHAR reserved1;
    UCHAR reserved2;
    UCHAR reserved3;
} USBIO_PIPE_CONFIGURATION_INFO;
```

Members

PipeType

Specifies the type of the pipe. The values are defined by the enumeration type **USBIO_PIPE_TYPE** ([page 214](#)).

MaximumTransferSize

Specifies the maximum size, in bytes, of data transfers the USB D supports on this pipe. This is the maximum size of buffers that can be used with read or write operations on this pipe.

MaximumPacketSize

Specifies the maximum packet size of USB data transfers the endpoint is capable of sending or receiving as reported by the device in the corresponding endpoint descriptor. Refer to the Universal Serial Bus Specification 1.1, Chapter 9 for more information.

EndpointAddress

Specifies the address of the endpoint on the USB device as reported in the corresponding endpoint descriptor.

The endpoint address includes the direction flag at bit position 7 (MSB)

Bit 7 = 0: OUT endpoint

Bit 7 = 1: IN endpoint

Refer to the Universal Serial Bus Specification 1.1, Chapter 9 for more information.

Interval

Specifies the interval, in milliseconds, for polling the endpoint for data as reported in the corresponding endpoint descriptor. The value is meaningful for interrupt endpoints only. Refer to the Universal Serial Bus Specification 1.1, Chapter 9 for more information.

InterfaceNumber

Specifies the index of the interface the pipe belongs to. The value corresponds to the field **InterfaceNumber** of an **USBIO_INTERFACE_CONFIGURATION_INFO** (page 200) structure.

reserved1

Reserved field set to zero.

reserved2

Reserved field, set to zero.

reserved3

Reserved field, set to zero.

Comments This structure is an output of **IOCTL_USBIO_GET_CONFIGURATION_INFO** (page 166) operations. Only active pipes from the current configuration are returned.

USBIO_CONFIGURATION_INFO

The USBIO_CONFIGURATION_INFO structure provides information about all interfaces and all pipes available in the current configuration.

Definition

```
typedef struct _USBIO_CONFIGURATION_INFO{
    ULONG NbOfInterfaces;
    ULONG NbOfPipes;
    USBIO_INTERFACE_CONFIGURATION_INFO
        InterfaceInfo[USBIO_MAX_INTERFACES];
    USBIO_PIPE_CONFIGURATION_INFO
        PipeInfo[USBIO_MAX_PIPES];
} USBIO_CONFIGURATION_INFO;
```

Members

NbOfInterface
Contains the number of interfaces. This is the number of valid entries in the **InterfaceInfo** structure.

NbOfPipes
Contains the number of pipes. This is the number of valid entries in the **PipeInfo** structure.

InterfaceInfo[USBIO_MAX_INTERFACES]
An array of USBIO_INTERFACE_CONFIGURATION_INFO (page 200) structures that describes the interfaces. There are **NbOfInterfaces** valid entries in this array.

PipeInfo[USBIO_MAX_PIPES]
An array of USBIO_PIPE_CONFIGURATION_INFO (page 202) structures that describes the pipes. There are **NbOfPipes** valid entries in this array.

Comments This structure is an output of **IOCTL_USBIO_GET_CONFIGURATION_INFO** (page 166) operations. Only active pipes from the current configuration are returned.

USBIO_FRAME_NUMBER

The USBIO_FRAME_NUMBER structure contains information about the USB frame counter value.

Definition `typedef struct _USBIO_FRAME_NUMBER{
 ULONG FrameNumber;
 } USBIO_FRAME_NUMBER;`

Members **FrameNumber**
 Contains the current value of the frame counter maintained by the USBD.

Comments This structure is an output of
IOCTL_USBIO_GET_CURRENT_FRAME_NUMBER ([page 168](#))
requests.

USBIO_DEVICE_POWER

The USBIO_DEVICE_POWER structure contains information about the USB device power states.

Definition `typedef struct _USBIO_DEVICE_POWER{
 USBIO_DEVICE_POWER_STATE DevicePowerState;
 } USBIO_DEVICE_POWER;`

Member **DevicePowerState**
 Contains the power state of the USB device. The values are defined by the **USBIO_DEVICE_POWER_STATE** ([page 217](#)) enumeration type.

Comments This structure is used with **IOCTL_USBIO_GET_DEVICE_POWER_STATE** ([page 170](#)) and **IOCTL_USBIO_SET_DEVICE_POWER_STATE** ([page 169](#)) requests.

USBIO_BIND_PIPE

The USBIO_BIND_PIPE structure provides information about the pipe to bind to.

Definition `typedef struct _USBIO_BIND_PIPE{
 UCHAR EndpointAddress;
 } USBIO_BIND_PIPE;`

Member **EndpointAddress**

Specifies the address of the endpoint on the USB device that shall be associated with the pipe. The endpoint address is specified as reported in the corresponding endpoint descriptor.

The endpoint address includes the direction flag at bit position 7 (MSB).

Bit 7 = 1: OUT endpoint

Bit 7 = 0: IN endpoint

Refer to the Universal Serial Bus Specification 1.1, Chapter 9 for more information.

Comments This structure has to be used as an input for IOCTL_USBIO_BIND_PIPE (page 174) operations. Only active endpoints from the current configuration can be bound.

USBIO_PIPE_PARAMETERS

The USBIO_PIPE_PARAMETERS structure contains pipe specific parameter settings of the USBIO driver.

Definition

```
typedef struct _USBIO_PIPE_PARAMETERS{
    ULONG Flags;
} USBIO_PIPE_PARAMETERS;
```

Member **Flags**

This field contains zero or the following value.

USBIO_SHORT_TRANSFER_OK

If this flag is set, the USBIO driver does not return an error during read operations from a Bulk or Interrupt pipe if a packet received from the device is shorter than the maximum packet size of the endpoint. Otherwise, a short packet causes an error condition. This option is meaningful for IN pipes only.

Comments This structure is intended to be used with **IOCTL_USBIO_GET_PIPE_PARAMETERS** (page 178) and **IOCTL_USBIO_SET_PIPE_PARAMETERS** (page 179) operations. The default setting of this parameter can be changed by means of the registry parameter `shortTransferOk`. This parameter has an effect only for read operations from Bulk or Interrupt pipes. For Isochronous pipes the flags in the appropriate ISO data structures are used (see **USBO_ISO_TRANSFER** (page 210)).

USBIO_PIPE_CONTROL_TRANSFER

The USBIO_PIPE_CONTROL_TRANSFER structure provides information used to generate a specific control request.

Definition

```
typedef struct _USBIO_PIPE_CONTROL_TRANSFER{
    ULONG Flags;
    UCHAR SetupPacket[8];
} USBIO_PIPE_CONTROL_TRANSFER;
```

Members **Flags**

This field contains zero or the following value.

USBIO_SHORT_TRANSFER_OK

If this flag is set, the USBIO driver does not return an error if a data packet received from the device is shorter than the maximum packet size of the endpoint. Otherwise, a short packet causes an error condition.

SetupPacket [8]

Specifies the setup packet to be sent to the device. The format of the eight byte setup packet is defined by the Universal Serial Bus Specification 1.1, Chapter 9.

Comments This structure has to be used as an input for **IOCTL_USBIO_PIPE_CONTROL_TRANSFER_IN** ([page 180](#)) and **IOCTL_USBIO_PIPE_CONTROL_TRANSFER_OUT** ([page 181](#)) operations.

USBIO_ISO_TRANSFER

The USBIO_ISO_TRANSFER structure provides information used for isochronous data transfers.

Definition

```
typedef struct _USBIO_ISO_TRANSFER {
    ULONG NumberOfPackets;
    ULONG Flags;
    ULONG StartFrame;
    ULONG ErrorCount;
} USBIO_ISO_TRANSFER;
```

Members **NumberOfPackets**

Specifies the number of packets to be sent to or received from the device. Each packet corresponds to an USB frame. The maximum number of packets in a read or write operation is limited by the registry parameter **MaxIsoPackets**.

Flags

This field contains zero or any combination (bit-wise or) of the following values.

USBIO_SHORT_TRANSFER_OK

If this flag is set, the USBIO driver does not return an error if a data packet received from the device is shorter than the maximum packet size of the endpoint. Otherwise, a short packet causes an error condition.

USBIO_START_TRANSFER_ASAP

If this flag is set, the transfer will be started as soon as possible and the **startFrame** parameter is ignored. This flag has to be used if a continuous data stream shall be sent to the isochronous endpoint of the USB device.

StartFrame

Specifies the frame number the transfer shall start with. The value has to be within a system-defined range relative to the current frame. The range is normally set to 1024 frames.

If **USBIO_START_TRANSFER_ASAP** is specified in **Flags**, this member has not to be set by the caller. It contains the frame number that the transfer started with, when the request is returned by the USBIO.

If **USBIO_START_TRANSFER_ASAP** is not specified in **Flags**, this member has to be set by the caller to the frame number this transfer shall start with. An error occurs if the frame number is outside of the valid range.

ErrorCount

Contains the total number of errors occurred during this transaction when the request is returned by the USBIO.

Comments

This structure is the fixed size part of the **USBIO_ISO_TRANSFER_HEADER** ([page 213](#)) that has to be used as an input for **ReadFile** and **WriteFile** operations with an isochronous pipe. the transfer buffer has to contain an **USBIO_ISO_TRANSFER_HEADER** ([page 213](#)) structure at offset zero.

USBIO_ISO_PACKET

The `USBIO_ISO_PACKET` structure defines the size and location of a single isochronous data packet within the transfer buffer that is used for isochronous data transfers.

Definition `typedef struct _USBIO_ISO_PACKET{`
 `ULONG Offset;`
 `ULONG Length;`
 `ULONG Status;`
`} USBIO_ISO_PACKET;`

Members **Offset**

Specifies the offset, in bytes, of the packet relative to the start of the data buffer. This parameter has to be specified by the caller for read and write operations.

Length

Specifies the size, in bytes, of the packet. This parameter has to be set by the caller for write operations. On read operations this field is set by the USBIO when the request is returned.

Status

Contains the final status code for the transfer of this packet when the request is returned by the USBIO.

Comments A variable size array of `USBIO_ISO_PACKET` structures is part of the **USBIO_ISO_TRANSFER_HEADER** ([page 213](#)) that has to be used as an input for `ReadFile` and `WriteFile` operations with an isochronous pipe. An `USBIO_ISO_PACKET` structure is required for each data packet to be transferred. The maximum number of data packets is limited by the registry parameter `MaxIsoPackets`.

USBIO_ISO_TRANSFER_HEADER

The `USBIO_ISO_TRANSFER_HEADER` structure defines the header that has to be contained in the data buffers that are used for isochronous transfers.

Definition

```
typedef struct _USBIO_ISO_TRANSFER_HEADER{
    USBIO_ISO_TRANSFER IsoTransfer;
    USBIO_ISO_PACKET IsoPacket[1];
} USBIO_ISO_TRANSFER_HEADER;
```

Members **IsoTransfer**

This is the fixed size part of the header. See the description of the **USBIO_ISO_TRANSFER** (page 210) structure for more information.

IsoPacket[1]

This is a variable length array of **USBIO_ISO_PACKET** (page 212) structures. Each member defines an isochronous packet to be transferred. The number of valid entries in this array is defined by the **NumberOfPackets** field of **IsoTransfer**. The maximum number of data packets is limited by the registry parameter **MaxIsoPackets**.

Comments The data buffer passed to **ReadFile** or **WriteFile** operations with an isochronous pipe has to contain a valid **USBIO_ISO_TRANSFER_HEADER** (page 213) structure at offset zero. After this header the buffer contains the isochronous data which is divided into packets. The **IsoPacket** array describes the location and the size of the data packets. Each data packet is transferred in a separate USB frame.

There must not be gaps between the data packets in the transfer buffer.

E.5.5 Enumeration Types

USBIO_PIPE_TYPE

The USBIO_PIPE_TYPE enumeration type contains values that identify the type of an USB pipe or an USB endpoint respectively.

Definition `typedef enum _USBIO_PIPE_TYPE{
 PipeTypeControl = 0, ;
 PipeTypeIsochronous ,
 PipeTypeBulk ,
 PipeTypeInterrupt
 } USBIO_PIPE_TYPE;`

Comments The meaning of the values is defined by the Universal Serial Bus Specification 1.1, Chapter 9.

USBIO_REQUEST_RECIPIENT

The USBIO_REQUEST_RECIPIENT enumeration type contains values that identify the recipient of an USB device request.

Definition `typedef enum _USBIO_REQUEST_RECIPIENT{`
 `RecipientDevice = 0,`
 `RecipientInterface,`
 `RecipientEndpoint,`
 `RecipientOther`
 `} USBIO_REQUEST_RECIPIENT;`

Comments The meaning of the values is defined by the Universal Serial Bus Specification 1.1, Chapter 9.

USBIO_REQUEST_TYPE

The USBIO_REQUEST_TYPE enumeration type contains values that identify the type of an USB device request.

Definition `typedef enum _USBIO_REQUEST_TYPE{
 RequestTypeClass = 1,
 RequestTypeVendor
 } USBIO_REQUEST_TYPE;`

Comments The meaning of the values is defined by the Universal Serial Bus Specification 1.1, Chapter 9.

The enumeration does not contain the Standard request type defined by the USB Specification. This is because only Class and Vendor requests are supported by the USB D interface. Standard requests are generated internally by the USB D.

USBIO_DEVICE_POWER_STATE

The USBIO_DEVICE_POWER_STATE enumeration type contains values that identify the power state of a device.

Definition `typedef enum _USBIO_DEVICE_POWER_STATE {`
 `DevicePowered0 = 0,`
 `DevicePowered1,`
 `DevicePowered2,`
 `DevicePowered3`
 `} USBIO_DEVICE_POWER_STATE;`

Entries **DevicePowered0**
 Device fully on, normal operation
DevicePowered1
 Suspend
DevicePowered2
 Suspend
DevicePowered3
 Device off

Comments The meaning of the values is defined by the Power Management specification.

E.5.6 Error Codes

Table E-2. Error Codes Defined by the USBIO Device Driver

USBIO_ERR_SUCCESS	(0x00000000L)
USBIO_ERR_CRC	(0xE0000001L)
USBIO_ERR_BTSTUFF	(0xE0000002L)
USBIO_ERR_DATA_TOGGLE_MISMATCH	(0xE0000003L)
USBIO_ERR_STALL_PID	(0xE0000004L)
USBIO_ERR_DEV_NOT_RESPONDING	(0xE0000005L)
USBIO_ERR_PID_CHECK_FAILURE	(0xE0000006L)
USBIO_ERR_UNEXPECTED_PID	(0xE0000007L)
USBIO_ERR_DATA_OVERRUN	(0xE0000008L)
USBIO_ERR_DATA_UNDERRUN	(0xE0000009L)
USBIO_ERR_RESERVED1	(0xE000000AL)
USBIO_ERR_RESERVED2	(0xE000000BL)
USBIO_ERR_BUFFER_OVERRUN	(0xE000000CL)
USBIO_ERR_BUFFER_UNDERRUN	(0xE000000DL)
USBIO_ERR_NOT_ACCESSED	(0xE000000FL)
USBIO_ERR_FIFO	(0xE0000010L)
USBIO_ERR_ENDPOINT_HALTED	(0xE0000030L)
USBIO_ERR_NO_MEMORY	(0xE0000100L)
USBIO_ERR_INVALID_URB_FUNCTION	(0xE0000200L)
USBIO_ERR_INVALID_PARAMETER	(0xE0000300L)
USBIO_ERR_ERROR_BUSY	(0xE0000400L)
USBIO_ERR_REQUEST_FAILED	(0xE0000500L)
USBIO_ERR_INVALID_PIPE_HANDLE	(0xE0000600L)
USBIO_ERR_NO_BANDWIDTH	(0xE0000700L)
USBIO_ERR_INTERNAL_HC_ERROR	(0xE0000800L)
USBIO_ERR_ERROR_SHORT_TRANSFER	(0xE0000900L)
USBIO_ERR_BAD_START_FRAME	(0xE0000A00L)
USBIO_ERR_ISOCH_REQUEST_FAILED	(0xE0000B00L)
USBIO_ERR_FRAME_CONTROL_OWNED	(0xE0000C00L)
USBIO_ERR_FRAME_CONTROL_NOT_OWNED	(0xE0000D00L)
USBIO_ERR_CANCELED	(0xE0010000L)
USBIO_ERR_CANCELING	(0xE0020000L)
USBIO_ERR_FAILED	(0xE0001000L)
USBIO_ERR_INVALID_INBUFFER	(0xE0001001L)
USBIO_ERR_INVALID_OUTBUFFER	(0xE0001002L)
USBIO_ERR_OUT_OF_MEMORY	(0xE0001003L)
USBIO_ERR_PENDING_REQUESTS	(0xE0001004L)
USBIO_ERR_ALREADY_CONFIGURED	(0xE0001005L)
USBIO_ERR_NOT_CONFIGURED	(0xE0001006L)
USBIO_ERR_OPEN_PIPES	(0xE0001007L)
USBIO_ERR_ALREADEY_BOUND	(0xE0001008L)

Table E-2. Error Codes Defined by the USBIO Device Driver (Continued)

USBIO_ERR_NOT_BOUND	(0xE0001009L)
USBIO_ERR_DEVICE_NOT_PRESENT	(0xE000100AL)
USBIO_ERR_CONTROL_NOT_SUPPORTED	(0xE000100BL)
USBIO_ERR_TIMEOUT	(0xE000100CL)
USBIO_ERR_INVALID_RECIPIENT	(0xE000100DL)
USBIO_ERR_INVALID_TYPE	(0xE000100EL)
USBIO_ERR_INVALID_IOCTL	(0xE000100FL)
USBIO_ERR_INVALID_DIRECTION	(0xE0001010L)
USBIO_ERR_TOO_MUCH_ISO_PACKETS	(0xE0001011L)
USBIO_ERR_POOL_EMPTY	(0xE0001012L)
USBIO_ERR_PIPE_NOT_FOUND	(0xE0001013L)
USBIO_ERR_INVALID_ISO_PACKET	(0xE0001014L)
USBIO_ERR_OUT_OF_ADDRESS_SPACE	(0xE0001015L)
USBIO_ERR_INTERFACE_NOT_FOUND	(0xE0001016L)
USBIO_ERR_INVALID_DEVICE_STATE	(0xE0001017L)
USBIO_ERR_INVALID_PARAM	(0xE0001018L)
USBIO_ERR_DEMO_EXPIRED	(0xE0001019L)
USBIO_ERR_INVALID_POWER_STATE	(0xE000101AL)
USBIO_ERR_POWER_DOWN	(0xE000101BL)
USBIO_ERR_VERSION_MISMATCH	(0xE000101CL)
USBIO_ERR_SET_CONFIGURATION_FAILED	(0xE000101DL)
USBIO_ERR_VID_RESTRICTION	(0xE0001080L)
USBIO_ERR_ISO_RESTRICTION	(0xE0001081L)
USBIO_ERR_BULK_RESTRICTION	(0xE0001082L)
USBIO_ERR_EP0_RESTRICTION	(0xE0001083L)
USBIO_ERR_PIPE_RESTRICTION	(0xE0001084L)
USBIO_ERR_PIPE_SIZE_RESTRICTION	(0xE0001085L)
USBIO_ERR_DEVICE_NOT_FOUND	(0xE0001100L)
USBIO_ERR_DEVICE_NOT_OPEN	(0xE0001102L)
USBIO_ERR_NO_SUCH_DEVICE_INSTANCE	(0xE0001104L)
USBIO_ERR_INVALID_FUNCTION_PARAM	(0xE0001105L)

E.6 USBIO Class Library

The USBIO Class Library (USBIO LIB) contains classes which provide wrapper functions for all of the features supported by the USBIO programming interface. Using these classes in an application is more convenient than using the USBIO interface directly. The classes are designed to be capable of being extended. In order to meet the requirements of a particular application new classes may be derived from the existing ones. The class library is provided fully in source code.

Figure E-4 shows the classes included in the USBIO LIB and their relations.

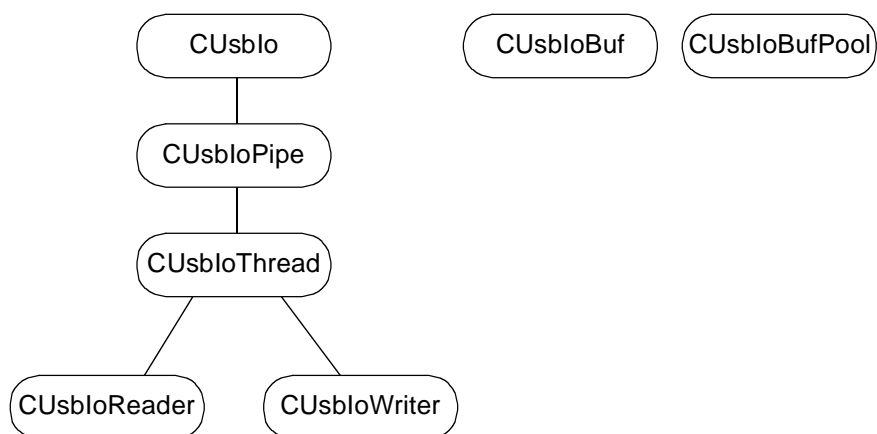

Figure E-4. USBIO Class Library

E.6.1 CUsblo Class

The class `CUsbIo` implements the basic interface to the USBIO device driver. It includes all functions that are related to an USBIO device object. Thus, by using an instance of the `CUsbIo` class all operations which do not require a pipe context can be performed.

The `CUsbIo` class supports device enumeration and an `Open` function that is used to connect an instance of the class to an USBIO device object. The handle that represents the connection is stored inside the class instance. It is used for all subsequent requests to the device.

For each device-related operation the USBIO driver supports, a member function exists in the `CUsbIo` class. The function takes the parameters that are required for the operation and returns the status that is reported by the USBIO driver.

E.6.2 CUsbIoPipe Class

The class `CUsbIoPipe` extends the `CUsbIo` class by functions that are related to an USBIO pipe object. An instance of the `CUsbIoPipe` class is associated directly with an USBIO pipe object. In order to establish the connection to the pipe the class provides a `Bind` function. After a `CUsbIoPipe` instance is bound, pipe-related functions can be performed by using member functions of the class.

For each pipe-related operation that the USBIO driver supports a member function exists in the `CUsbIoPipe` class. The function takes the parameters that are required for the operation and returns the status that is reported by the USBIO driver.

The `CUsbIoPipe` class supports an asynchronous communication model for data transfers from or to the pipe. The `Read` or `Write` function is used to submit a data buffer to the USBIO driver. The function returns immediately indicating success if the buffer was sent to the driver successfully. There is no blocking within the `Read` or `Write` function. Therefore, it is possible to send multiple buffers to the pipe. The buffers are processed sequentially in the same order as they were submitted. The `WaitForCompletion` member function is used to wait until the data transfer from or to a particular buffer is finished. This function blocks the calling thread until the USBIO driver has completed the I/O operation with the buffer.

In order to use a data buffer with the `Read`, `Write`, and `WaitForCompletion` functions of the `CUsbIoPipe` class the buffer has to be described by a `CUsbIoBuf` object. The `CUsbIoBuf` helper class stores context information while the read or write operation is pending.

E.6.3 CUsbIoThread Class

The class `CUsbIoThread` provides basic functions needed to implement a worker thread that performs input or output operations on a pipe. It includes functions that are used to start and stop the worker thread.

The `CUsbIoThread` class does not implement the thread's main routine. This has to be done in a derived class. Thus, `CUsbIoThread` is an universal base class that simplifies the implementation of a worker thread that performs I/O operations on a pipe.

NOTE: *The worker thread created by `CUsbIoThread` is a native system thread. That means it cannot be used to class MFC (Microsoft Foundation Classes) functions. It is necessary to use `PostMessage`, `SendMessage` or some other communication mechanism to switch over to MFC-aware threads.*

E.6.4 CUsbIoReaderClass

The class `CUsbIoReader` extends the `CUsbIoThread` class by a specific worker thread routine that continuously sends Read requests to the pipe. The thread's main routine gets buffers from an internal buffer pool and submits them to the pipe using the `Read` function of the `CUsbIoPipe` class. After all buffers are submitted the routine waits for the first pending buffer to complete. If a buffer is completed by the USBIO driver the virtual member function `ProcessData` is called with this buffer. Within this function the data received from the pipe should be processed. The `ProcessData` function has to be implemented by a class that is derived from `CUsbIoReader`. After that, the buffer is put back to the pool and the main loop is started from the beginning.

E.6.5 CUsbIoWriter Class

The class `CUsbIoWriter` extends the `CUsbIoThread` class by a specific worker thread routine that continuously sends Write requests to the pipe. The thread's main routine gets a buffer from an internal buffer pool and calls the virtual member function `ProcessBuffer` to fill the

buffer with data. After that, the buffer is sent to the pipe using the `write` function of the `CUsbIoPipe` class. After all buffers are submitted the routine waits for the first pending buffer to complete. If a buffer is completed by the USBIO driver the buffer is put back to the pool and the main loop is started from the beginning.

E.6.6 CUsbIoBufClass

The helper class `CUsbIoBuf` is used as a descriptor for buffers that are processed by the class `CUsbIoPipe` and derived classes. One instance of the `CUsbIoBuf` class has to be created for each buffer. The `CUsbIoBuf` object stores context and status information that is needed to process the buffer asynchronously.

The `CUsbIoBuf` class contains a link element (Next pointer). This may be used to build a chain of linked buffer objects to hold them in a list. This way, the management of buffers can be simplified.

E.6.7 CUsbIoBufPool Class

The class `CUsbIoBufPool` is used to manage a pool of free buffers. It provides functions used to allocate an initial number of buffers, to get a buffer from the pool, and to put a buffer back to the pool.

E.7 USBIO Demo Application

The USBIO Demo Application demonstrates the usage of the USBIO driver interface. It is based on the USBIO Class Library which covers the native API calls. The Application is designed to handle one USB driver that can contain multiple pipes. It is possible to run multiple instances of the application, each connected to another USB device.

The USBIO Demo Application is a dialog based MFC (Microsoft Foundation Classes) application. The main dialog contains a button that allows to open an output window. All output data and all error messages are directed to this window. The button "Clear Output Window" discards the actual contents of the window.

The main dialog contains several dialog pages which allow to access the device-related driver operations. From the dialog page “Pipes” a separate dialog can be started for each configured pipe. The pipe dialogs are non-modal. More than one pipe dialog can be opened at a given point in time.

E.7.1 Dialog Pages for Device Operations

E.7.1.1 Device

This page allows to scan for available devices. The application enumerates the USBIO device objects currently available. It opens each device object and queries the USB device descriptor. The USB devices currently attached to USBIO are listed in the output window. A device can be opened and closed, and the device parameters can be requested or set.

Related driver interfaces:

- `CreateFile()`;
- `CloseHandle()`;
- `IOCTL_USBIO_GET_DEVICE_PARAMETERS` ([page 164](#))
- `IOCTL_USBIO_SET_DEVICE_PARAMETERS` ([page 165](#))

E.7.1.2 Descriptors

This page allows to query standard descriptors from the device. The index of the configuration and the string descriptors can be specified. The descriptors are dumped to the output window. Some descriptors are interpreted. Unknown descriptors are presented as HEX dump.

Related driver interfaces:

- `IOCTL_USBIO_GET_DESCRIPTOR` ([page 151](#))

E.7.1.3 Configuration

This page is used to set a configuration, to unconfigure the device, or to request the current configuration.

Related driver interfaces:

- **IOCTL_USBIO_GET_DESCRIPTOR** ([page 151](#))
- **IOCTL_USBIO_GET_CONFIGURATION** ([page 156](#))
- **IOCTL_USBIO_STORE_CONFIG_DESCRIPTOR** ([page 158](#))
- **IOCTL_USBIO_SET_CONFIGURATION** ([page 159](#))
- **IOCTL_USBIO_UNCONFIGURE_DEVICE** ([page 160](#))

E.7.1.4 Interface

By using this page the alternate setting of a configured interface can be changed.

Related driver interfaces:

- **IOCTL_USBIO_SET_INTERFACE** ([page 161](#))
- **IOCTL_USBIO_GET_INTERFACE** ([page 157](#))

E.7.1.5 Pipes

This page allows to show all configured endpoints and interfaces by using the button “Get Configuration Info”. A new non-modal dialog for each configured pipe can be opened as well.

Related driver interfaces:

- **IOCTL_USBIO_GET_CONFIGURATION_INFO** ([page 166](#))
- **IOCTL_USBIO_BIND_PIPE** ([page 174](#))
- **IOCTL_USBIO_UNBIND_PIPE** ([page 175](#))

E.7.1.6 Class or Vendor Request

By using this page a class or vendor specific request can be send to the USB device.

Related driver interfaces:

- **IOCTL_USBIO_CLASS_OR_VENDOR_IN_REQUEST** ([page 162](#))
- **IOCTL_USBIO_CLASS_OR_VENDOR_OUT_REQUEST** ([page 163](#))

E.7.1.7 Feature

This page can be used to send set or clear feature requests.

Related driver interfaces:

- **IOCTL_USBIO_SET_FEATURE** ([page 153](#))
- **IOCTL_USBIO_CLEAR_FEATURE** ([page 154](#))

E.7.1.8 Other

This page allows to query the device state, to reset the USB device, to get the current frame number, and to query or set the device power state.

Related driver interfaces:

- **IOCTL_USBIO_GET_STATUS** ([page 155](#))
- **IOCTL_USBIO_RESET_DEVICE** ([page 167](#))
- **IOCTL_USBIO_GET_CURRENT_FRAME_NUMBER** ([page 168](#))
- **IOCTL_USBIO_SET_DEVICE_POWER_STATE** ([page 169](#))
- **IOCTL_USBIO_GET_DEVICE_POWER_STATE** ([page 170](#))

E.7.1.9 Dialog Pages for Pipe Operations

Three different types of pipe dialogs can be selected. For IN pipes a **Read from pipe to file** dialog and a **Read from pipe to output window** dialog can be activated. For OUT pipes a **Write from file to pipe** dialog can be started. The pipe dialog **Read from pipe to output window** cannot be used with isochronous pipes.

When a new pipe dialog is opened it is bound to a pipe. If the dialog is closed the pipe is unbound. Each pipe dialog contains pipe-related and transfer-related functions. The first three dialog pages are the same in all pipe dialogs. The last page has a special meaning.

E.7.1.10 Pipe

By using this page it is possible to access functions Reset Pipe, Abort Pipe, Get Pipe Parameters, and Set Pipe Parameters.

Related driver interfaces:

- **IOCTL_USBIO_RESET_PIPE** ([page 176](#))
- **IOCTL_USBIO_ABORT_PIPE** ([page 177](#))
- **IOCTL_USBIO_GET_PIPE_PARAMETERS** ([page 178](#))
- **IOCTL_USBIO_SET_PIPE_PARAMETERS** ([page 179](#))

E.7.1.11 Buffers

By means of this page the size and the number of buffers can be selected. For Interrupt and Bulk pipes the “Size of Buffer” field is relevant. For Isochronous pipes the “Number of Packets” field is relevant and the required buffer size is calculated internally. In the “Max Error Count” field a maximum number of errors can be specified. When this number is exceeded, the data transfer is aborted. Each successful transfer resets the error counter to zero.

E.7.1.12 Control

This dialog page allows to access user-defined control pipes. It cannot be used to access the default pipe (endpoint zero) of an USB device.

Related driver interfaces:

- **IOCTL_USBIO_PIPE_CONTROL_TRANSER_IN** ([page 180](#))
- **IOCTL_USBIO_PIPE_CONTROL_TRANSFER_OUT** ([page 181](#))

E.7.1.13 Read from Pipe to Output Window

This dialog page allows to read data from an Interrupt or Bulk pipe and to dump it to the output window. For large amounts of data the transfer may be slowed down because of the overhead involved with printing to the output window. The printing of the data can be enabled/disabled by the switch **Print to Output Window**.

Related driver interfaces:

- **ReadFile()**;
- **IOCTL_USBIO_ABORT_PIPE** ([page 177](#))

E.7.1.14 Read from Pipe to File

This dialog page allows to read data from the pipe to a file. This transfer type can be used for Isochronous pipes as well. The synchronization type of the Isochronous pipe has to be “asynchronous”. The application does not support data rate feedback.

Related driver interfaces:

- **ReadFile()**;
- **IOCTL_USBIO_ABORT_PIPE** ([page 177](#))

E.7.1.15 Write from File to Pipe

This dialog page allows to write data from a file to the pipe. This transfer type can be used for Isochronous pipes as well. The synchronization type of the isochronous pipe has to be “asynchronous”. The application does not support data rate feedback.

Related driver interfaces:

- `WriteFile()`;
- `IOCTL_USBIO_ABORT_PIPE` ([page 177](#))

E.8 Installation Issues

This section discusses the topics related to installation of the USBIO device driver. Included is a description of how a customized driver setup can be built.

IMPORTANT: On Windows 2000 administrator rights are required to install a device driver. Because the USBIO driver is installed in the same way as any other Plug&Play device driver the installation requires administrator rights. Once the USBIO driver is installed standard user rights are sufficient to load the driver and to use the driver by accessing its programming interface.

E.8.1 Automated Installation: The USBIO Installation Wizard

Using the USBIO Installation Wizard is the quickest and easiest way for installing the USBIO device driver. This wizard performs the driver installation automatically in a step-by-step procedure. The device the USBIO driver will be installed for can be selected from a list. It is not necessary to manually edit or copy any files. After installation is complete the wizard allows to save the specific setup files that has been generated for the selected device. These files can be used at a later time to manually install the USBIO driver for the same device, without using the Installation Wizard.

The steps required to install the USBIO driver by using the Installation Wizard are described below.

- On Windows 2000 make sure you are logged on as an administrator or have enough privileges to install device drivers on the system. In general, special privileges are required to install device drivers on Windows 2000.
- Connect your USB device to the system. After plugging in the device Windows launches the New Hardware Wizard and prompts you for a device driver. Complete the New Hardware Wizard by clicking Next on each page and Finish on the last page. Windows either installs a system-provided driver or registers the device as “Unknown”.

Do not abort the New Hardware Wizard by clicking the Cancel button. This will prevent Windows from enumerating the device and storing enumeration information in the registry. As a result of this, the device is not visible in the system and USBIO Installation Wizard is not able to install the driver for it.

For some kinds of devices the system does not launch the New Hardware Wizard. A system-provided device driver will be installed silently. This will happen if the device belongs to a predefined device class, Human Interface Devices (HID), Audio Devices, or Printer Devices for example. The USBIO Installation Wizard is able to install the USBIO driver for such devices but this will disable any system-provided driver.

- Start the USBIO Installation Wizard by selecting the appropriate shortcut from the Start menu. It is also possible to start the wizard directly by executing USBIOwiz.exe.
- The first page shows some hints concerning the installation process. Click the Next button to continue. Note that you can abort the Installation Wizard at any time by clicking the Cancel button.
- On the next page the wizard shows a list containing all USB devices currently connected to the system. Select the device the USBIO driver shall be installed for. The Hardware ID will be shown for the selected device. A Hardware ID is a string that is used internally by the operating system to unambiguously identify the

device. It is built from a bus identifier (USB), the 16-bit vendor ID (VID), the 16-bit product ID (PID), and optionally the revision code (REV). The IDs and the revision code are reported by the device in the USB Device Descriptor.

If your device is not shown in the list make sure it is plugged in properly and you have finished the New Hardware Wizard as described above. You may use the Device Manager to check if the device was enumerated by the system. The Device Manager can be accessed by right-clicking the “My Computer” icon on the desktop and then choosing Properties.

Use the Refresh button to rescan for active devices and to rebuild the list.

To continue, click the Next button.

- The next page shows detailed information about the selected USB device. If a driver is already installed for the device information about the driver is also shown. Verify that you selected the correct device. If not, use the Back button to return to the device list and select another device.

To install the USBIO driver for the selected device, click the Next button.

WARNING: *If you install the USBIO driver for a device that is currently controlled by another device driver the existing driver will be disabled. This will happen immediately. As a result, the device may no longer be used by the operating system and by applications. If the device belongs to the HID class, a mouse or a keyboard for example, this can cause problems.*

- On the last page the Installation Wizard shows the completion status of driver installation. If the installation was successful the USBIO driver is running. It has been dynamically loaded by the operating system.

The USBIO Installation Wizard allows you to save the specific driver installation file (INF) that it generated for the device. The INF file is specific for the selected device because it contains the Hardware ID of that device. You can use the button labeled “Save INF file” to save the generated INF file with a name of your choice

and in a location of your choice. The Installation Wizard copies also the USBIO driver binary file `usbio.sys` to the same location as the INF file. You can use these files at a later time to install the USBIO driver manually.

You can use the button labeled “Run USBIO Application” to start the demo application that is included in the USBIO package. The application allows you to test several USB operations manually. Please refer to [E.7 USBIO Demo Application](#) for further information.

To quit the USBIO Installation Wizard, click Finish.

E.8.2 Manual Installation: The USBIO Setup Information File

A Setup Information File (INF) is required for proper installation of the USBIO device driver. This file describes the driver to be installed and defines the operations to be performed during the installation process.

An INF file is in ASCII text format. It can be viewed and modified with any text editor, Notepad for example. The contents and the syntax of an INF file are documented in the Microsoft Windows 2000 DDK.

The INF file is loaded and interpreted by a software component that is built into the operating system, called Device Installer. The Device Installer is closely related to the Plug&Play Manager that handles hot plugging and removal of USB devices. After the Plug&Play Manager has detected a new USB device the system searches its internal INF file data base, located in `%WINDIR%\INF\`, for a matching driver. If no driver can be found the New Hardware Wizard pops up and the user will be asked for a driver.

The association of device and driver is based on a string that is called Hardware ID. The Plug&Play Manager builds the Hardware ID string from the 16-bit vendor ID (VID), the 16-bit product ID (PID), and optionally the revision code (REV). The string is prefixed by the bus identifier USB. Examples for Hardware ID strings are:

```
USB/VID_046D&PID_0100
USB/VID_046D&PID_C001&REV_0401
USB/CLASS_09&SUBCLASS_01&PROT_00
```

As shown in the last example a Hardware ID can also describe a device class and subclass. This makes it possible to provide a driver that will be used whenever the system detects a device that belongs to a specific device class. An example for such a kind of driver is the system-provided HID mouse driver. This driver is installed for any type of USB mouse, regardless of the vendor, the USB Vendor ID, and the USB Product ID. The driver selection is based on the class, subclass, and protocol identifiers. Please refer to the Microsoft Windows 2000 DDK for detailed information on Hardware IDs and driver selection algorithms. Another good source of information are the INF files that ship with the operating system. They are located in a subdirectory of the Windows system directory, named "INF". Note that on Windows 2000 this subdirectory has a Hidden attribute by default.

In order to prepare an installation disk that can be used to install the USBIO driver for your device the following steps are required.

- Copy the USBIO driver binary `usbio.sys` to a floppy disk or to a directory location of your choice. Copy the INF file `usbio.inf` provided with the USBIO package to the same location. Note that you can choose any name for the INF file, based on your company name or your product name for example. But the file name extension has to be `.inf`. In the following discussion it is assumed the INF file is named `usbio.inf`.
- Open the `usbio.inf` file using a text editor, Notepad for example. Edit the `[_Devices]` section. There are various examples of Hardware ID strings prepared in this section. Select one of the examples that matches your needs. Usually, the very first example is appropriate. It associates the USBIO driver with your device by using the USB Vendor ID and Product ID. Remove the semi-colon at the start of the line and replace the `VID_XXXX` and `PID_XXXX` placeholders in the Hardware ID string by your USB Vendor ID and Product ID as shown in the examples above. Note that the IDs are given as 4-digit hexadecimal numbers.
- Edit the `[strings]` section at the end of the `usbio.inf` file to modify the device description string for your device, defined by the value of `s_DeviceDesc1`. The device description text will be displayed in the Device Manager next to the icon that represents your device.
- Save the INF file to accommodate your changes.

Now you are prepared to start the driver installation. The required steps are described below.

- Connect your USB device to the system. After plugging in the device Windows launches the New Hardware Wizard and prompts you for a device driver. Provide the New Hardware Wizard with the location of your installation files (usbio.inf and usbio.sys). Complete the wizard by following the instructions shown on screen. If the INF file matches with your device the driver should be installed successfully.

Note that on Windows 2000 and Windows Millennium the New Hardware Wizard shows a warning message that complains about the fact that the driver is not certified and digitally signed. You may ignore this warning and continue with driver installation. The USBIO driver is not certified because it is not an end-user product. When the USBIO driver is integrated into such a product it is possible to get a certification and a digital signature from the Windows Hardware Quality Labs (WHQL).

- If the device belongs to a predefined device class that is supported by the operating system, the system does not launch the New Hardware Wizard after the device is plugged in. Instead of that a system-provided device driver will be installed silently. Human Interface Devices (HID) like mice and keyboards, Audio Devices, or Printer Devices are examples for such devices. The operating system does not ask for a driver because it finds a matching entry for the device's class and subclass ID in its internal INF file data base, as mentioned above.

Use the Device Manager to install the USBIO driver for a device for that a driver is already running. To start the Device Manager choose Properties on the "My Computer" icon on the desktop. In the Device Manager locate your device and choose Properties on the entry. On the property page that pops up choose Driver and click the button labeled "Update Driver". The Upgrade Device Driver Wizard is started which is similar to the New Hardware Wizard mentioned above. Provide the wizard with the location of your installation files (usbio.inf and usbio.sys) and complete the driver installation by following the instructions shown on screen.

- For some device classes, especially HID devices like mice and keyboards, Windows does not allow you to install a driver with a different device class. That means you have to modify the device class entry in the [Version] section of the usbio.inf file to match with the device's class. The device class is specified by the keywords `Class` and `ClassGUID` in the [Version] section.

For example, if you want to use a keyboard or a mouse to test the USBIO driver the new entries should be

```
Class=HIDClass and  
ClassGUID={745a17a0-74d3-11d0-b6fe-00a0c90f57da}.
```

The ClassGUID value that is associated with a device class can be found in system-provided INF files in %WINDIR%\INF\ or in the Windows 2000 DDK documentation.

NOTE: *At least two drivers are used for USB keyboard and mouse devices. One belongs to the USB HID class and the other one belongs to the keyboard or mouse class. The keyboard or mouse driver runs on top of the USB HID driver. The USBIO driver can replace the USB HID driver only. In the Device Manager the HID driver is shown in a section labeled "Human Interface Devices". To be sure to replace the correct driver refer to the "Driver File Details" dialog in the Properties page of the entry. If the driver stack contains the file HIDUSB.SYS then you have selected the correct entry in the Device Manager.*

- In the Device manager the section "Universal Serial Bus controllers" contains an item labeled "USB Root Hub".

Do not install USBIO for the USB Root HUB!

The USB Root Hub is not an USB device. It is built into the USB host controller and is controlled by a special device driver provided by the operating system.

- After the driver installation was successfully completed your device should be shown in the Device Manager in the section that corresponds to the device class you specified in the usbio.inf file. You may use the Properties dialog box of that entry to verify that the USBIO driver is installed and running.
- In order to verify that the USBIO driver is working properly with your device you should use the USBIO Demo Application USBIOAPP.EXE. Please refer to [E.7 USBIO Demo Application](#) for detailed information on the Demo Application.

E.8.3 Uninstalling USBIO

In order to uninstall USBIO for a given device the Device Manager has to be used. The Device Manager can be accessed by right-clicking on “My Computer” icon on the desktop and then choosing Properties. In the Device Manager double-click on the entry of the device and choose the property page that is labeled “Driver”. There are two options:

- Remove the device from the system by clicking the button “Uninstall”. The operating system will reinstall a driver the next time the device is connected or the system is rebooted.
- Install a new driver for the device by clicking the button “Update Driver”. The operating system launches the Upgrade Device Driver Wizard which searches for driver files or lets you select a driver.

In order to avoid that USBIO is reinstalled automatically and silently by the operating system it is necessary to manually remove the INF file that was used to install the USBIO driver.

During driver installation Windows stores a copy of the INF file in its internal INF file data base that is located in `%WINDIR%\INF\`. The original INF file is renamed and stored as `oemX.inf` for example, where X is a decimal number. The exact INF naming scheme depends on the operating system (Windows 2000 uses a slightly different scheme than Windows 98). The best way to find the correct INF file is to do a search for some significant string in all the INF files in the directory `%WINDIR%\INF\` and its subdirectories.

Note that on Windows 98 and Windows ME the INF file may also be stored in a directory named `%WINDIR%\INF\OTHER\`. Another naming scheme based on the provider name is used in that case.

Note also that on Windows 2000 the `%WINDIR%\INF\` directory has a Hidden attribute by default. Therefore, the directory is not shown in Windows Explorer by default.

Once you have located the INF file, delete it. This will prevent Windows from reinstalling the USBIO driver. Instead of that the New Hardware Wizard will be launched and you will be asked for a driver.

E.8.4 Building a Customized Driver Setup

When the USBIO driver is included and shipped with a retail product some setup parameters should be customized. This is necessary because the USBIO device driver might be used by several vendors and it is possible that an user has two products and that both of them use the USBIO driver. This can cause conflicts with respect to the file name of the driver executable, the location of registry parameters, the device names, and the driver interface GUIDs used. To avoid such problems a vendor who redistributes the USBIO driver for use with a hardware product should choose a new file name for the driver binary, generate a private interface GUID, and select a private location in the registry to be used to store startup parameters. In order to do that the `usbio.inf` file has to be customized as well.

The following list shows the steps required to build a customized USBIO setup:

- Choose a new name for the driver binary file `usbio.sys`. The name should not cause conflicts with drivers provided by Windows. Rename the file `usbio.sys` to your new name.
- Rename the Setup Information file `usbio.inf`. You can choose any name you want. For instance, the name may be based on your company's or your product's name. Note that the file extension should not be changed. It has to be ".inf".
- Edit the `[_CopyFiles_sys]` section in the INF file to include the new name of the driver binary.
- Edit the value `S_DriverName` in the `[Strings]` section to match with the new name you defined for the driver binary.
- Edit the `[strings]` section in the INF file to modify text strings that are shown at the user interface level. You may change the following parameters:

```
S_Provider
S_Mfg
S_DeviceClassDisplayName
S_DeviceDesc1
S_DiskName
S_ServiceDisplayName
```

- Edit the following values in the `[Strings]` section to specify a location in the Registry that is used to store the USBIO driver's configuration parameters:

`S_ConfigPath`

`S_DeviceConfigPath1`

Note the `S_ConfigPath` should specify a location that is a subkey of

`HKEY_LOCAL_MACHINE\SYSTEM\CurrentControlSet\Services.`

The name of the subkey should be the same as the name you chose for the driver binary.

- Generate a private Globally Unique Identifier (GUID) to unambiguously identify the device instances that will be created by USBIO for your device. Use GUIDGEN.EXE from the Microsoft Platform SDK or from the Visual C++ package for this purpose. Copy the text representation of the GUID to the line in the INF file that defines the registry value `USBIO_UserInterfaceGuid`. Activate this line by removing the ";" at the beginning. Use the private GUID in your application to search for available devices. GUIDGEN.EXE allows you to export a `static const struct GUID = {...}` statement that can be included in the source code of an application. For an example, refer to the source code of USBIOAPP or ReaderCpp.
- Edit the driver parameter settings in the sections `_Parameters1_98` and `_Parameters1_NT`. The parameters in `_Parameters1_98` define the default behaviour of the USBIO driver on Windows 98. The parameters in `_Parameters1_NT` define the default behaviour of the USBIO driver on Windows 2000. For a detailed description of the supported settings, refer to [E.9 Registry Entries](#).
- After you finished testing your INF file remove any lines and comments that are not needed. Especially, make sure that the word USBIO does not occur in the files you ship with your product. This is a requirement that is defined by the USBIO licensing conditions. See also the License Agreement you received with the USBIO package.

E.9 Registry Entries

The behaviour of the driver can be customized by startup parameters stored in the registry. The parameters are stored under a path that is specified in the INF file. This registry path is

\HKEY_LOCAL_MACHINE\System\CurrentControlSet\Services\USBIO\Parameters
by default.

The location can be customized by changing the `s_ConfigPath` and `s_DeviceConfigPath1` variables in the `[Strings]` section of the INF file.

The driver reads the parameters when a new device object is added. If a parameter does not exist when the driver attempts to read it, the driver creates the entry using an internal default value.

Table E-3 lists all registry parameters.

Table E-3. Registry Parameters Supported by the USBIO Driver

Value	Min	Default	Max	Description
RequestTimeout	0	1000		Time-out interval for synchronous I/O requests, in milliseconds. Zero means infinite (no time-out).
ShortTransferOk	0	1	1	If set to 1 short packets in read transfers are allowed. If set to 0 short packets in read transfers cause errors.
UnconfigureOnClose	0	1	1	If set to 1 the device will be unconfigured when the last file handle is closed. If set to 0 the device state is not changed.
ResetDeviceOnClose	0	0	1	If set to 1 the device receives an USB reset if the last file handle is closed. If set to 0 the device state is not changed.
EnableRemoteWakeup	0	1	1	If set to 1 Remote Wakeup is enabled. If set to 0 Remote Wakeup is disabled.
MaxIsoPackets	16	64	512	Maximum number of packets allowed is an isochronous data transfer.
PowerStateOnOpen	0	0	3	Device power state that will be set when the device is opened (first handle is opened). 0...3 correspond to D0...D3

Table E-3. Registry Parameters Supported by the USBIO Driver (Continued)

Value	Min	Default	Max	Description
PowerStateOnClose	0	3	3	Device power state that will be set when the device is closed (last handle is closed). 0...3 correspond to D0...D3
MinPowerStateUsed	0	3	3	The minimum power state of the device while it is used (open handles exist). On system suspend the device is not allowed to go into states higher than this value. 0...3 correspond to D0...D3 The value 0 (D0) means: no suspend allowed if the device is in use. The value 3 (D3) means: full suspend (off) allowed if the device is in use.
MinPowerStateUnused	0	3	3	The minimum power state of the device while it is not used (no open handles exist). On system suspend the device is not allowed to go into states higher than this value. 0...3 correspond to D0...D3 The value 0 (D0) means: no suspend allowed if the device is not in use. The value 3 (D3) means: full suspend (off) allowed if the device is not in use
AbortPipesOnPowerDown	0	0	1	Handling of outstanding read or write requests when the device goes into a suspend state (leaves D0): 1 = abort pending requests 0 = do not abort pending requests
SuppressPnPRemoveDlg	0	1	1	If this flag is set, Windows 2000 does not show a warning dialog if the device is removed.
DebugPort	0	0	3	Destination of trace messages for debugging purposes: 0 = kernel debugger or debug monitor 1...3 = COM1...COM3 This parameter is available only if the debug (checked) build of the USBIO driver is used.
DebugMask	0	3		Control of message output for debugging. This parameter is available only if the debug (checked) build of the USBIO driver is used.
DebugBaud	2.400	57.600	115.200	Baudrate selection for debug output to COM port. This parameter is available only if the debug (checked) build of the USBIO driver is used.

E.10 Related Documents

- Universal Serial Bus Specification 1.0, 1.1
- USB device class specifications (Audio, HID, Printer, etc.)
- Windows 2000 DDK Documentation
- Windows 98 DDK Documentation
- Microsoft Platform SDK Documentation

E.11 Light Version Limitations

The light version for MCT Elektronikladen of the USBIO driver has the following limitations:

1. The Vendor ID of your device has to match with the Vendor ID 0x0C70 of MCT Elektronikladen. You can contact MCT Elektronikladen to receive a unique product ID.

Possible error codes when this restriction is offended:
USBIO_ERR_VID_RESTRICTION

2. Only one Interrupt IN endpoint and one Interrupt OUT endpoint is supported. If your device has more endpoints or other endpoint types configuring the device (SET_CONFIGURATION) will fail.

Possible error codes when this restriction is offended:
USBIO_ERR_PIPE_RESTRICTION
USBIO_ERR_BULK_RESTRICTION
USBIO_ERR_ISO_RESTRICTION

3. The maximum FIFO size of an endpoint is limited to eight bytes.

Possible error codes when this restriction is offended:
USBIO_ERR_PIPE_SIZE_RESTRICTION

4. The maximum size of the data stage for a Class or Vendor Request is limited to eight bytes.

Possible error codes when this restriction is offended:
USBIO_ERR_EP0_RESTRICTION

How to Reach Us:

USA/EUROPE/LOCATIONS NOT LISTED:

Motorola Literature Distribution
P.O. Box 5405
Denver, Colorado 80217
1-303-675-2140
1-800-441-2447

TECHNICAL INFORMATION CENTER:

1-800-521-6274

JAPAN:

Motorola Japan Ltd.
SPS, Technical Information Center
3-20-1, Minami-Azabu, Minato-ku
Tokyo 106-8573 Japan
81-3-3440-3569

ASIA/PACIFIC:

Motorola Semiconductors H.K. Ltd.
Silicon Harbour Centre
2 Dai King Street
Tai Po Industrial Estate
Tai Po, N.T., Hong Kong
852-26668334

HOME PAGE:

<http://www.motorola.com/semiconductors/>



MOTOROLA

DRM002/D