

Particle swarm optimization based high performance four switch BLDC motor drive

Yaser Anagreh¹, Moath Bani Fayyad², Aysha Anagreh³

¹Department of Electrical Power Engineering, Hijjawi Faculty for Engineering Technology, Yarmouk University, Irbid, Jordan

²Department of Electrical Power Engineering, Budapest University for Technology and Economics, Budapest, Hungary

³ Department of Architectur Engineering, Hijjawi Faculty for Engineering Technology, Yarmouk University, Irbid, Jordan

Article Info

Article history:

Received Nov 9, 2021

Revised Mar 17, 2022

Accepted Apr 4, 2022

Keywords:

BLDC Motor

Four switch inverter

PSO algorithm

ABSTRACT

The present publication is directed to utilize particle swarm optimization (PSO) algorithm based PI controller for adjusting the speed of brushless DC motor fed via four switch three phase inverter. The inverter topology reduces the cost and complexity of the drive system. High performance response during transient and steady state conditions is achieved by optimizing the controller gains using POS algorithm. The obtained results confirm the validity of the proposed drive configuration in providing the features of fast dynamic response (the settling time is about 0.025 s), with minimized percentage overshoot, and approximately zero steady state error. Moreover, the drive system shows robustness feature when subjected to external load torque disturbances.

This is an open access article under the [CC BY-SA](https://creativecommons.org/licenses/by-sa/4.0/) license.

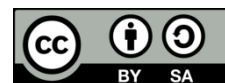

Corresponding Author:

Yaser Anagreh

Department of Electrical Power Engineering, Hijjawi Faculty for Engineering Technology

Yarmouk University, Irbid, Jordan

Email: anagrehy@yu.edu.jo

1. INTRODUCTION

Nowadays, brushless direct current (BLDC) motors are increasingly implemented in a wide range of applications such as automation and industrial control, aerospace, computers, robotics, and household products [1]-[7]. Moreover, hybrid and electric vehicles, which represent a powerful alternative to conventional vehicles, are extensively utilizing BLDC motor to acquire high performance and reliable traction system [8]-[10]. The popularity of utilizing this motor type in various applications is due to their merits over other motor types, including high efficiency, higher power density, reduced noise, low inertia, low maintenance, high torque/weight ratio and compact size [1], [7], [11]-[14].

The commutation of BLDC motors is achieved electronically via position transducers. Based on the rotor position information, a three-phase inverter accomplishes the appropriate switching for the current supplying the motor to achieve maximum possible torque [15]. To minimize the cost of the inverter circuit, reduce switching losses and simplify the control design four-switch three-phase inverter, instead of six switches three phase inverter, is used [16]-[20]. For this inverter topology, direct current pulse-width modulation (PWM) control method, instead of voltage controlled PWM approach, is used to overcome asymmetric voltage PWM [20]. This inverter configuration has two arms containing four power electronic switches and the third arm has two capacitors of equal capacitance value. The inverter has six switching states each for 60° electrical. Two states are two-switch control and the other four states are one-switch control [18]. During one-switch control states, only one of the four switches is on and the current completes its path through one of the two capacitors. For the two-switch control states, two switches are on; the upper

switch from one leg and the lower switch from the other leg. Consequently, the switching sequence is accomplished through six modes [21].

In the literature, several approaches have been used for speed control of BLDC motor fed by six switch inverters. In [22] and [23] the authors have implemented sliding mode control to adjust BLDC motor speed. Abdulhussein *et al.* [2] utilized PID controller enhanced with butterfly and particle swarm optimization algorithms for BLDC motor speed control. Vinida and Chacko [25] have applied H-infinity controller and weight filters to achieve sensorless BLDC motor speed control. In [25] the authors have compared the use of PI and fuzzy logic controllers for speed control of BLDC motor under different operating conditions. The use of an integrated fuzzy logic/sliding mode controller for speed control of BLDC motor is presented in [26], [27]. Obed *et al.* have utilized PID controller enhanced with wavelet neural network and particle swarm optimization (PSO) algorithm to improve the dynamic speed performance of BLDC motor drive [28]. Song *et al.* [29] has used a random vibration particle swarm optimization (PSO)–gravitational search algorithm (GSA) method in designing fuzzy PI controller for brushless DC motor (BLDCM) drive. They concluded that the proposed approach is superior compared with PSO and GSA. The authors of [30] have implemented neural network approach for sensorless speed control of BLDC motor. They found that the neural network-based controller is outperforming the PID controller in terms of the robustness feature to variable load torque changes. Fractional order PID (FOPID) controller enhanced with firefly algorithm (FA) is utilized by Kommula and Kota [31] to adjust the speed and torque of BLDC motor. A comparison with GA based FOPID controller has been made in this publication. Vanchinathan and Selvaganesan [32] have applied artificial bee colony (ABC) based tuned fractional order PID (FOPID) controller for controlling sensorless BLDC motor under different loading conditions. Based on the comparison made with GA and the modified GA based FOPID controllers, tremendous improvements in the motor performance are achieved with the proposed method. In publication [33] coronavirus optimization algorithm (CVOA) based tuned PID controller is used to adjust the speed of BLDC motor subjected to different disturbance types.

The main contribution of the present work is the achievement of low cost high performance brushless DC motor drive system having the features of fast dynamic response, reduced percentage overshoot, about zero steady state error and robust to external disturbances for a wide speed range. Reduced cost and complexity drive are acquired using four switch three phase inverter. The desired time specifications of the speed response are achieved through the implementation of particle swarm optimization (PSO) for tuning the gains of the PI speed controller.

2. MATHEMATICAL MODELING OF BLDC MOTOR

The mathematical model of BLDC motor can be divided into electrical and mechanical subsystems [1], [2]. The electrical equivalent circuit of a BLDC motor is shown in Figure 1. The considered BLDC motor in the current study is inner rotor type with symmetrical stator windings. Therefore, stator resistances as well as stator inductances are equal:

- $R_a = R_b = R_c = R$, $L_a = L_b = L_c = L$. In addition, the mutual inductances are assumed to be equal:
- $M_{ab} = M_{ba} = M_{ac} = M_{ca} = M_{bc} = M_{cb} = M$. The electrical mathematical model of the motor can be expressed in matrix form as [7], [23], [25]:

$$\begin{bmatrix} v_a \\ v_b \\ v_c \end{bmatrix} = \begin{bmatrix} R & 0 & 0 \\ 0 & R & 0 \\ 0 & 0 & R \end{bmatrix} \begin{bmatrix} i_a \\ i_b \\ i_c \end{bmatrix} + \begin{bmatrix} L & M & M \\ M & L & M \\ M & M & L \end{bmatrix} \frac{d}{dt} \begin{bmatrix} i_a \\ i_b \\ i_c \end{bmatrix} + \begin{bmatrix} e_a \\ e_b \\ e_c \end{bmatrix} \quad (1)$$

The current relationship can be expressed as:

$$i_a + i_b + i_c = 0 \quad (2)$$

The back-EMF of the motor depends on the speed of the rotor and the flux of the rotor permanent magnets. It can be given by:

$$\begin{bmatrix} e_a \\ e_b \\ e_c \end{bmatrix} = \frac{k_e \omega_m}{2} \begin{bmatrix} F(\theta_e) \\ F(\theta_e - \frac{2\pi}{3}) \\ F(\theta_e + \frac{2\pi}{3}) \end{bmatrix} \quad (3)$$

The function $F(\theta_e)$ represents the trapezoidal waveform of the back-EMF. It can be expressed by:

$$F(\theta_e) = \begin{cases} 1 & 0 \leq \theta_e < \frac{2\pi}{3} \\ 1 - \frac{6}{\pi}(\theta_e - \frac{2\pi}{3}) & \frac{2\pi}{3} \leq \theta_e < \pi \\ -1 & \pi \leq \theta_e < \frac{5\pi}{3} \\ -1 + \frac{6}{\pi}(\theta_e - \frac{5\pi}{3}) & \frac{5\pi}{3} \leq \theta_e < 2\pi \end{cases} \quad (4)$$

Based on Newton's law, the motion equation of BLDC motor can be described as [12], [25]:

$$T_e - T_L = B\omega_m - J \frac{d\omega_m}{dt} \quad (5)$$

The angular rotor position θ_r can be obtained from the integration of the angular velocity as:

$$\theta_r = \int \omega_m dt \quad (6)$$

The electromagnetic torque depends on the current, speed and the back EMF. The instantaneous electromagnetic torque can be mathematically expressed by the following equation [12], [23]:

$$T_e = \frac{1}{\omega_m} (e_a i_a + e_b i_b + e_c i_c) \quad (7)$$

were B is the viscous friction constant, e_a, e_b, e_c are the back EMF of each stator phase, i_a, i_b, i_c are stator phase currents, k_e is the back-EMF constant, L_a, L_b, L_c are the stator phase self-inductances, M_a, M_b, M_c are the stator phase mutual inductances, R_a, R_b, R_c are the stator phase resistances, T_e is the electromagnetic torque, T_L is the load torque, v_a, v_b, v_c are stator phase voltages, θ_e is the electrical angle, θ_r is the angular rotor position, ω_m is the angular mechanical speed.

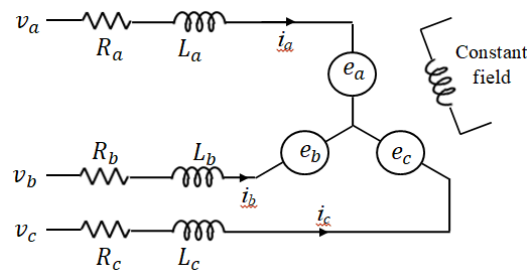

Figure 1. Equivalent circuit of a BLDC motor

3. THE PROPOSED MOTOR DRIVE SYSTEM

The schematic diagram of the proposed brushless DC motor drive system is shown in Figure 2. The motor drive system includes two control loops. In the outer loop (speed control loop) the actual speed is compared with the reference speed to generate the error signal, which is fed to the block of the particle swarm optimization (PSO). The PSO algorithm provides the optimum values for the PI controller gains based on the motor operating condition. The output of the PI controller (control signal) represents the reference signal to the hysteresis current controller (the inner loop). The current controller, with the help of the information provided from the position sensors, adjusts the duty cycle of the PWM fed to the four-switch inverter in order to provide the required voltage level in the correct switching sequence.

The simulink model of the proposed system is shown in Figure 3. The output speed in rpm is subtracted from the reference speed and the error is supplied to the subsystem of PSO based tuned PI controller to provide an output control signal, which represent the reference current signal. The later signal and the position information are fed to the subsystem of the hysteresis current controller which order the inverter with the proper switching commands. The detailed Simulink structure of the hysteresis current controller is shown in Figure 4.

To assess the implementation of four switch inverter in feeding a BLDC motor drive, extensive simulations are conducted for both four switch inverter and six switch inverter-based models. After achieving the validity of using the four-switch inverter, the PI controller subsystem is enhanced with PSO algorithm for

auto tuning the gains to attain high performance BLDC motor drive. The validity of the proposed system is confirmed by comparing the obtained results with those obtained using trial and error tuning approach. In addition, step point tracking of the two tuning approaches is compared. The results obtained for all investigated conditions are presented in the following section.

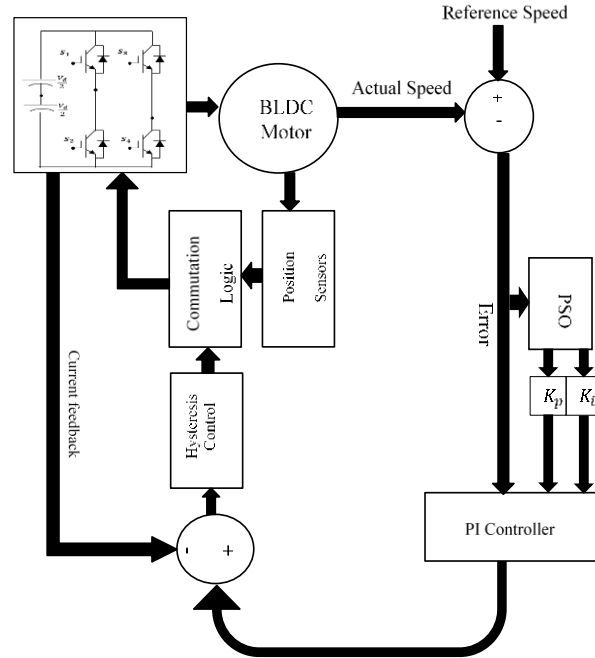

Figure 2. Schematic diagram of the proposed BLDC motor drive system

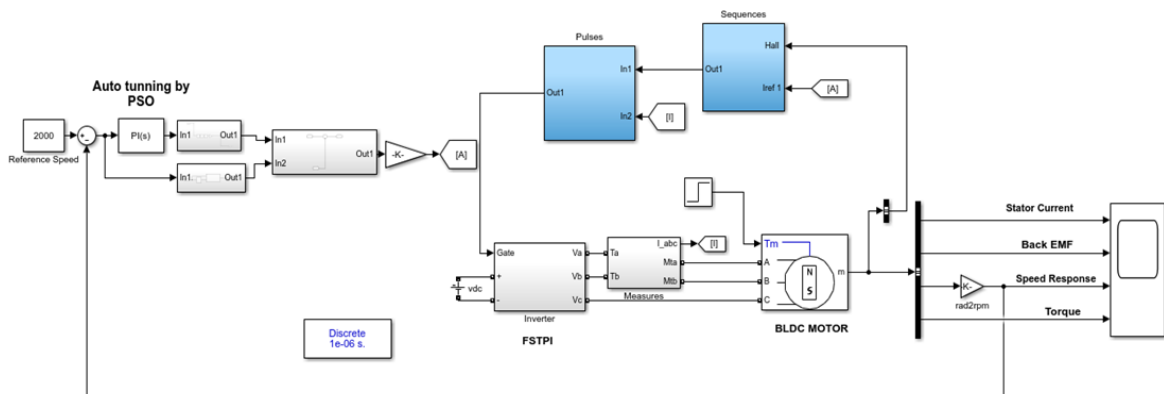

Figure 3. Simulink model of the proposed BLDC motor drive system

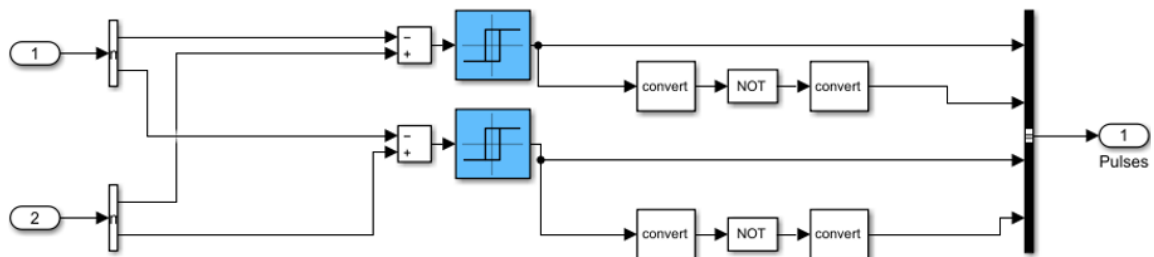

Figure 4. Simulink sub-system of hysteresis current controller

4. RESULTS AND DISCUSSION

The results presented in this section are obtained for a BLDC motor having a stator resistance per phase of 2.875Ω , stator inductance per phase of 8.5 mH , torque constant of 0.84 Nm/A , moment of inertia constant of $0.8 \times 10^{-3} \text{ kg.m}^2$, viscous friction constant of $0.5 \times 10^{-5} \text{ Nm.s}$ and four pole pairs. The obtained results for speed response of BLDC motor fed by six switch inverter is shown in Figure 5. The corresponding results for the motor supplied through four-switch inverter are shown in Figure 6. For the two configurations, a disturbance of 2.5 N.m load torque is applied after 0.15 second of starting. Extensive simulations are carried out for the two schemes to achieve the best PI controller gains and the best band for the hysteresis current controller. As can be observed, the obtained results for speed response of BLDC motor drive fed by four-switch inverter are close to the corresponding results of six switch inverter configuration. The close agreement between the results of the two configurations motivates the use of four-switch inverter, which leads to a BLDC motor drive system having the features of reduced cost, less complexity and minimized switching losses.

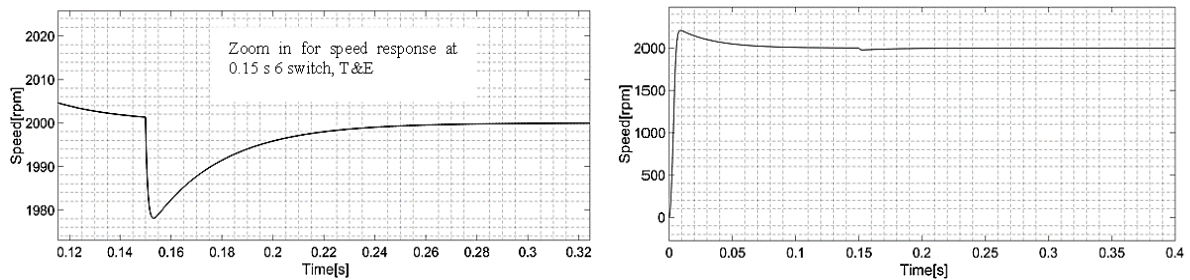

Figure 5. Closed loop speed response of BLDC motor drive fed by a six-switch inverter

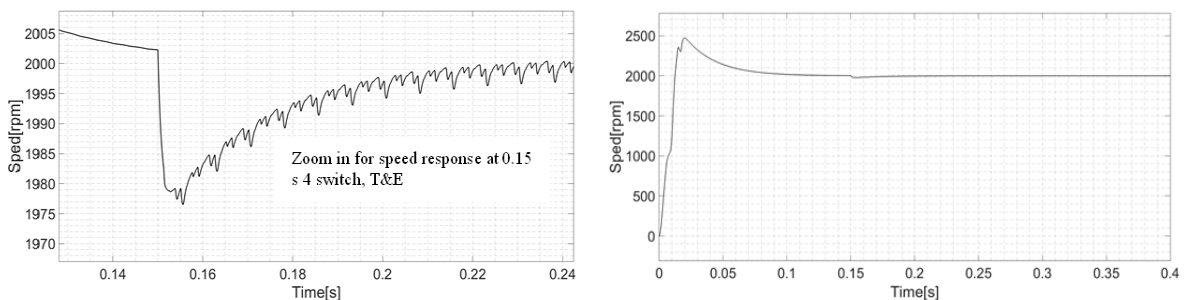

Figure 6. Closed loop speed response of BLDC motor drive fed by a four-switch inverter

The results of speed, current, back-EMF and electromagnetic torque for PSO based tuning the speed control of the BLDC motor fed via four switch inverter are shown in Figures 7-10 respectively. A disturbance of 2.5 N.m load torque is applied after 0.15 second of starting. The PSO algorithm succeeded to find the optimum PI controller gains k_p and k_i after 40 iterations. The obtained values for k_p and k_i are 4.911 and 0.122 , respectively. From the results of the time response for speed, current, back EMF and electromagnetic torque, it can be noticed that the utilized control approach provides fast response and very short recovery time in response to the application of external load torque disturbance. The spikes shown in the results of the current and electromagnetic torque during the first 20 ms of starting are due to a problem in the startup of the Simulink simulations. A comparison between the results of Figure 7 with those presented in Figure 6 confirms the validity of the proposed control system. A tremendous improvement in the motor speed response, during both transient and steady-state operating conditions, can be observed.

Table 1 presents a comparison between the time specifications for speed response of PSO based tuned speed controller of BLDC motor drive fed by four inverter switches (the proposed system) with those obtained using trial and error approach for the same system. It can be noticed that the proposed BLDC motor drive system provides a noticeable improvement in the speed response. The proposed system has the features of fast dynamic response, reduced percentage overshoot and zero steady-state error.

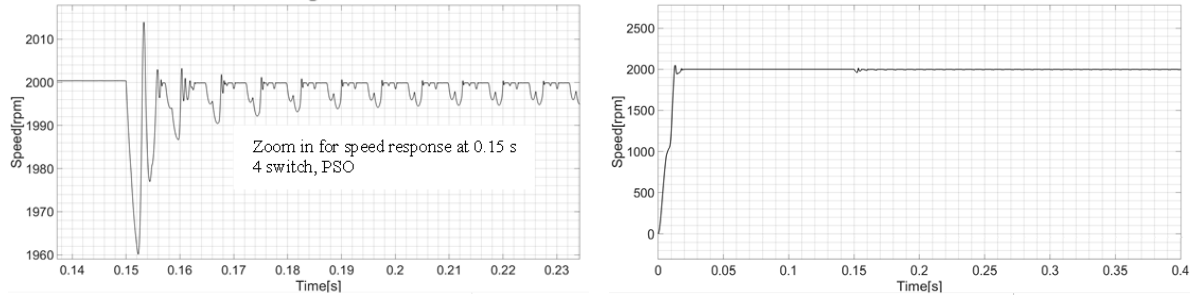

Figure 7. Response of PSO based tuning speed control of BLDC motor drive fed by a four-switch inverter

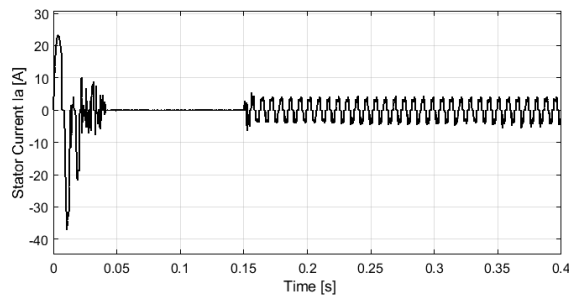

Figure 8. Current response of PSO based tuned PI controller for BLDC motor drive fed by four switch inverters

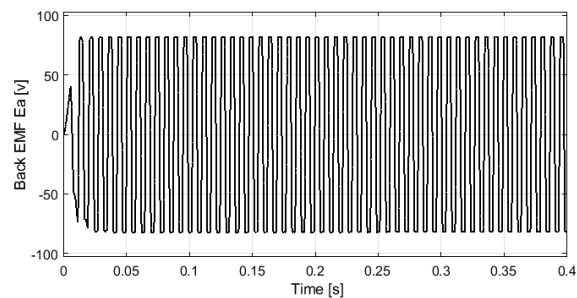

Figure 9. Back EMF response of PSO based tuned PI controller of BLDC motor drive fed by four switch inverters

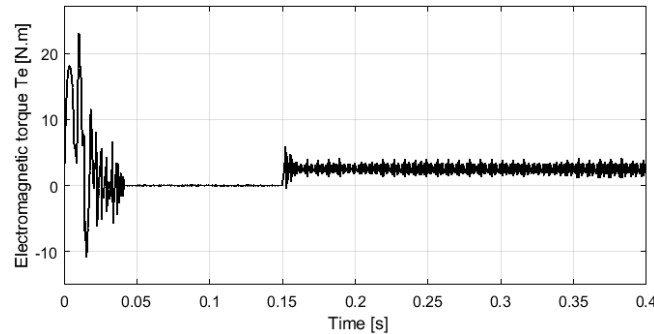

Figure 10. Electromagnetic torque response of PSO based tuned PI controller of BLDC motor drive fed by four switch inverters

Table 1. Time specifications for speed control of BLDC motor fed by four-switch inverter

Time Specification	Trial and error-based tuning	PSO based tuning
Settling time, t_s (sec)	0.15	0.025
Overshoot (%O.S)	25%	3.33%
Steady state error, e_{ss} (%)	0	0

Set point tracking is an important feature of feedback speed control since it shows the behavior of the controller in tracking the changes in the reference speed. The results of set point tracking for the changes in reference speed, with applied load torque of 2.5 N.m, for speed control of BLDC motor drive fed by four switch inverter is shown in Figure 11. The PI speed controller gains of the outer loop in this configuration are obtained using trial and error approach. The corresponding results for the use of particle swarm optimization (POS) to tune the PI controller gains are shown in Figure 12. It can be seen that the utilization of PSO for tuning the PI speed controller has greatly minimized the overshoot during the changes in the reference speed;

the percentage overshoot is approximately zero. Moreover, the time response of each step is minimized (faster response) and the steady state error is reduced. The results obtained enhance the validity and the accuracy of the proposed BLDC motor drive configuration.

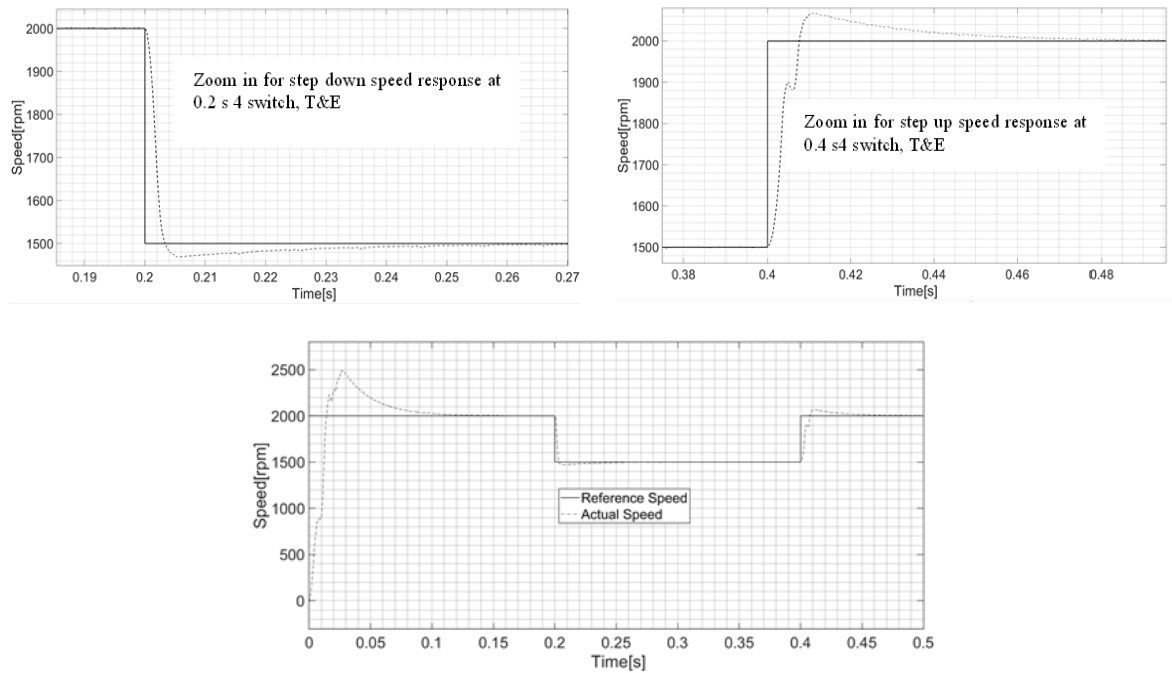

Figure 11. Set point tracking for trial and error based tuning PI speed controller of BLDC motor drive fed by four switch inverters

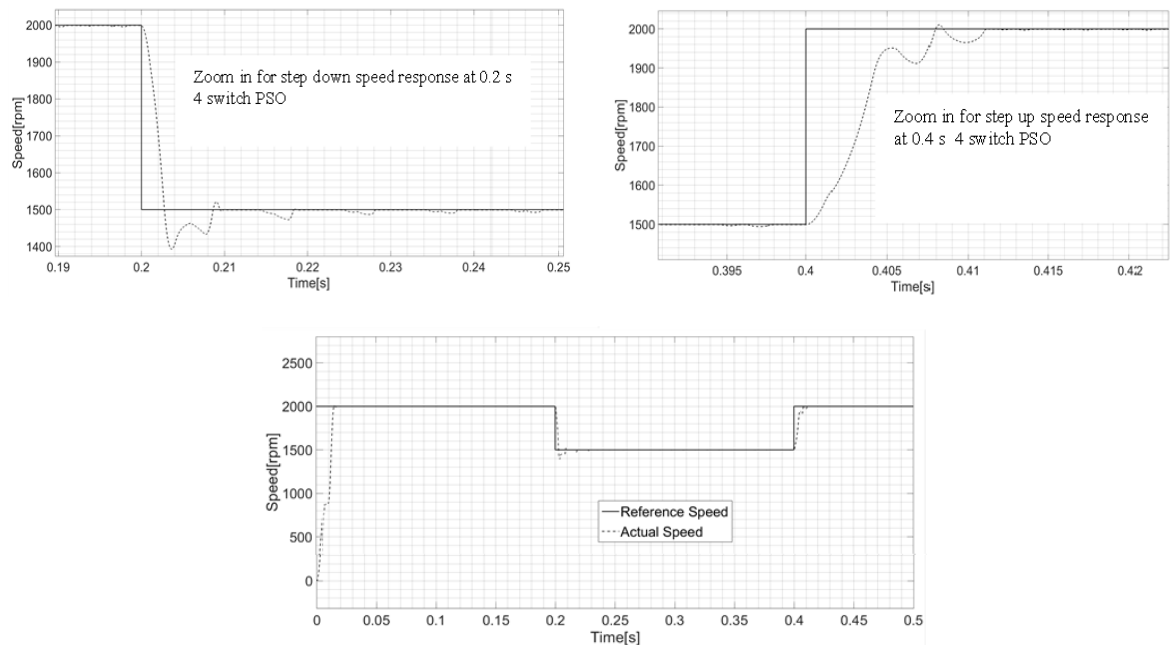

Figure 12. Set point tracking for PSO based tuning PI speed controller of BLDC motor drive fed by four switch inverters

The obtained results for the time responses of current and electromagnetic torque under the same operating conditions of the above set point tracking of the proposed drive system are shown in Figure 13 and

Figure 14, respectively. It can be observed that the proposed drive system has the features of fast dynamic response and the ability of recovering to a new state within a very short time period, in response to the changes in reference speed. As stated before, the appearance of spikes during the first 20 ms is due to a problem in startup of Simulink simulations.

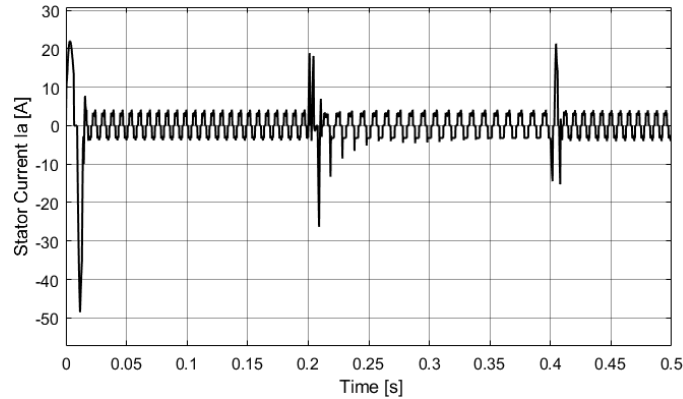

Figure 13. Current response for step changes in reference speed of the proposed brushless DC motor drive system

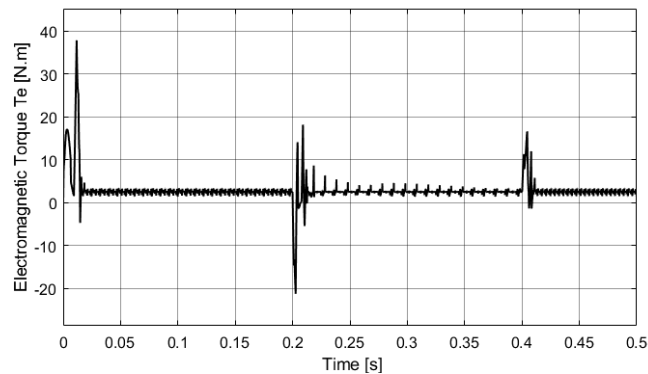

Figure 14. Electromagnetic torque response for step change in reference speed of the proposed BLDC motor drive

4. CONCLUSION

Particle swarm optimization (PSO) based tuning PI speed control BLDC motor fed by four switch inverters has been investigated in the present research work. Four-switch inverter, instead of the conventional six-switch inverter, is used to minimize the cost, switching losses and complexity of BLDC motor drive system. The PSO algorithm is utilized to achieve high performance speed control motor drive system. To confirm the validity, extensive simulations for BLDC motor drive configurations under different operating conditions are carried out. The results obtained show that the proposed controller poses the best time response features. It has a fast dynamic response (settling time is approximately 0.025 s), approximately zero percentage overshoot and nearly zero steady state errors. Moreover, the speed controller is robust to external load disturbances.

REFERENCES

- [1] R. Goswami and D. Joshi, "Performance review of fuzzy logic based controllers employed in brushless DC motor", *Procedia Computer Science*, vol. 132, pp. 623-631, 2018, doi: 10.1016/j.procs.2018.05.061.
- [2] K. G. Abdulhussein, N. M. Yasin and I. J. Hasan, "Comparison between butterfly optimization algorithm and particle swarm optimization for tuning cascade PID control system of PMDC motor", *International Journal of Power Electronics and Drive Systems (IJPEDS)*, vol. 12, no. 2, pp. 736-744, Jun 2021, doi: 10.11591/ijpeds.v12.i2.pp736-744.





- [3] B. L. Theraja, "A textbook of electrical technology", S. Chand Publishing, 2008.
- [4] W. H. Ali, M. N. O. Sadiku and S. Abood, "Fundamentals of Electric Machines: A Primer with MATLAB", CRC Press, 2019.
- [5] J. Bae, K. Cho and D.-H. Lee, "Parallel Position Control Scheme of Permanent Magnet DC Motors with a Low-Resolution Sensor," 2020 *IEEE International Conference on Industrial Technology (ICIT)*, 2020, pp. 199-204, doi: 10.1109/ICIT45562.2020.9067269.
- [6] Z. Adel, A. A. Hamou and S. Abdellatif, "Design of Real-time PID tracking controller using Arduino Mega 2560 for a permanent magnet DC motor under real disturbances," 2018 *International Conference on Electrical Sciences and Technologies in Maghreb (CISTEM)*, 2018, pp. 1-5, doi: 10.1109/CISTEM.2018.8613560.
- [7] K. Chakkarapania, T. Thangavelub, K. Dharmalingamb and P.Thandavarayan, "Multiobjective design optimization and analysis of magnetic flux distribution for slotless permanent magnet brushless DC motor using evolutionary algorithms," *Journal of Magnetism and Magnetic Materials*, vol. 476, pp. 524-537, April 2019, doi: 10.1016/j.jmmm.2019.01.029
- [8] A. Flah, I. A. Khan, A. Agarwal, L. Sbitaa and M. G. Simoesb, "Field-oriented control strategy for double-stator single-rotor and double-rotor single-stator permanent magnet machine: Design and operation", *Computers and Electrical Engineering*, vol. 90, pp. 1-15, Mar. 2021, doi: 10.1016/j.compeleceng.2020.106953.
- [9] F. Aymen, O. Berkati, S. Lassaad and M. N. Srifi, "BLDC Control Method Optimized by PSO Algorithm," 2019 *International Symposium on Advanced Electrical and Communication Technologies (ISAECT)*, 2019, pp. 1-5, doi: 10.1109/ISAECT47714.2019.9069718.
- [10] F. Aymen and S. lassaad, "Overview on BLAC and BLDC motors: designs and mathematical modelling," *International Journal of Powertrains*, vol. 10, no. 1, p. 239, Mar. 2021, doi: 10.1504/IJPT.2021.10040735.
- [11] C. Xia, J. Liu, W. Yu and Z. Li, "Variable structure control of BLDCM based on extended state observer," *IEEE International Conference Mechatronics and Automation*, vol. 2, 2005, pp. 568-571, doi: 10.1109/ICMA.2005.1626612.
- [12] P. Selvakumar, "Certain investigation on performance of BLDC motor using PID fuzzy logic and cascaded hybrid controllers," *Ph.D. Thesis, Faculty of Information and Communication Engineering, Anna University, Chennai India*, 2014
- [13] J. Wang, L. B. Zhou and G. L. Tao, "Design and Analysis of a Multiphase Permanent Magnet Brushless DC Motor Drive System for High Power Applications," 2007 *2nd IEEE Conference on Industrial Electronics and Applications*, 2007, pp. 1182-1187, doi: 10.1109/ICIEA.2007.4318594.
- [14] D. S. Nayak and R. Shivarudraswamy, "Solar fed BLDC motor drive for mixer grinder using a boost converter," *International Journal of Power Electronics and Drive System (IJPEDS)*, vol. 11, No. 1, pp. 56-63, March 2020, doi: 10.11591/ijpeds.v11.i1.pp56-63.
- [15] U. Vinatha, S. Pola and K. P. Vittal, "Recent Developments in Control Schemes of BLDC Motors," 2006 *IEEE International Conference on Industrial Technology*, 2006, pp. 477-482, doi: 10.1109/ICIT.2006.372247.
- [16] Vanisri, "Cost effective sensorless speed Control of permanent magnet Brushless dc motor", *Ph. D. Thesis, Faculty of Electrical and Electronics Engineering, Anna University*, February 2014, Chennai India.
- [17] J. E. Muralidhar, and P. Varanasi, "Analysis of four Switch and six switch converter fed BLDC with fixed and variable Speeds," *International Journal of Engineering and Science Research*, vol. 4, no. 6, pp. 324-332, June 2014.
- [18] G. James and K. Radhakrishnan, "Simulation of four switch BLDC motor drive," *International Journal of Latest Trends in Engineering and Technology (IJLTET)*, Vol. 2, No. 4, pp. 100-106, July 2013.
- [19] J. Sukhwani, "Performance Evaluation of 3-Phase 4-Switch Inverter Fed Brushless DC Motor Drive," *Master Thesis, Electrical Engineering Department, Indian Institute University for Science and Technology*, 2012, Roorkee Indian
- [20] B.-K. Lee, T.-H. Kim and M. Ehsani, "On the feasibility of four-switch three-phase BLDC motor drives for low cost commercial applications: topology and control," in *IEEE Transactions on Power Electronics*, vol. 18, no. 1, pp. 164-172, Jan. 2003, doi: 10.1109/TPEL.2002.807125.
- [21] O. Mohammed, "A study of control systems for Brushless DC motors," *Master Thesis, University of Toledo, Ohio, UT*, 2014
- [22] H. M. Soliman, E. H. E. Bayoumi and M Soliman, "Linear-matrix-inequality-based sliding mode control for brushless d.c. motor drives," *Proceedings of the Institution of Mechanical Engineers, Part I: Journal of Systems and Control Engineering*, Vol. 223, No. 8, pp. 1035-1043, August 2009, doi: 10.1243/09596518JSC808.
- [23] K. Orman, K. Can, A. Başcı and A. Derdiyok, "Real-time speed control of BLDC motor based on fractional sliding mode controller," *International Journal of Applied Mathematics, Electronics and Computers*, vol. 4, no. 1, pp. 314- 318, Dec. 2016.
- [24] K. Vinida and M. Chacko, "Implementation of speed control of sensorless brushless DC motor drive using H-infinity controller with optimized weight filters," *International Journal of Power Electronics and Drive Systems (IJPEDS)*, vol. 12, no. 3, pp. 1379-1389, Sept. 2021, doi: 10.11591/ijpeds.v12.i3.pp1379-1389.
- [25] A. H. Ahmed, A. E. S. B. Kotb and A. M. Ali, "Comparison between Fuzzy Logic and PI Control for the Speed of BLDC Motor," *International Journal of Power Electronics and Drive System (IJPEDS)*, vol. 9, no. 3, pp. 1116-1123, Sept. 2018, doi: 10.11591/ijpeds.v9n3.pp1116-1123.
- [26] Mousmi, A. Abbou and Y. El Houm, "Real-time implementation of a novel hybrid fuzzy sliding mode control of a BLDC motor," *International Journal of Power Electronics and Drive System (IJPEDS)*, vol. 10, no. 3, pp. 1167-1177, Sep 2019, doi: 10.11591/ijpeds.v10.i3.pp1167-1177.
- [27] K. M. Prasad and U. Nair, "Intelligent fuzzy sliding mode controller based on FPGA for the speed control of a BLDC motor," *International Journal of Power Electronics and Drive System (IJPEDS)*, vol. 11, no. 1, pp. 477-486, March 2020, doi: 10.11591/ijpeds.v11.i1.pp477-486.
- [28] A. Obed, A. L. Saleh and A. K. Kadhim, "Speed performance evaluation of BLDC motor based on dynamic wavelet neural network and PSO algorithm," *International Journal of Power Electronics and Drive System (IJPEDS)*, vol. 10, no. 4, pp. 1742-1750, Dec. 2019, doi: 10.11591/ijpeds.v10.i4.1742-1750.
- [29] B. Song, Y. Xiao and L. Xu, "Design of fuzzy PI controller for brushless DC motor based on PSO-GSA algorithm," *Systems Science & Control Engineering*, vol. 8, no. 1, pp. 67-77, Feb. 2020, doi: 10.1080/21642583.2020.1723144.
- [30] O-D. Ramírez-Cárdenas and F. Trujillo-Romero, "Sensorless Speed Tracking of a Brushless DC Motor Using a Neural Network",

Mathematical and Computational Applications, vol. 25, no. 57, pp. 1-20, Sept. 2020, doi: 10.3390/mca25030057.





- [31] B. N. Kommula and V. R. Kota, "Direct instantaneous torque control of Brushless DC motor using firefly Algorithm based fractional order PID controller," *Journal of King Saud University-Engineering Sciences*, vol. 32, pp. 133 – 140, 2018, doi: 10.1016/j.jksues.2018.04.007.
- [32] K. Vanchinathan and N. Selvagesan, "Adaptive fractional order PID controller tuning for brushless DC motor using Artificial Bee Colony algorithm," *Results in Control and Optimization*, vol. 4, pp. 1-18, June 2021, doi: 10.1016/j.rico.2021.100032.
- [33] M. A. Shamseldin, "Optimal Coronavirus Optimization Algorithm Based PID Controller for High Performance Brushless DC Motor", *Algorithms*, vol. 14, no. 193, pp. 1-17, June 2021, doi: 10.3390/a14070193.

BIOGRAPHIES OF AUTHORS







Yaser Anagreh     is a professor in Electrical Power Engineering Department at Yarmouk University, Irbid, Jordan. He received his B.Sc. in Electrical Engineering from University of Technology, Baghdad, Iraq, in 1984; M.Phil. and Ph.D. degrees in Electrical Engineering from University of Wales, Swansea, UK in 1995 and 1998, respectively. He has been a professor in YU, Irbid, Jordan since 2013. He is currently a faculty member in EPE Department at YU. His research interests include electrical machines, electric motor drives and renewable energy systems. He can be contacted at email: anagreh@yu.edu.jo



Mo'ath Bani Fayyad     is a Ph.D. student in Budapest University of Technology and Economics, Budapest, Hungary. He received his B.Sc. and M.Sc. degrees in Electrical Power Engineering from Yarmouk University, Irbid, Jordan, in 2013 and 2019, respectively. He was working as a quality control engineer with KADDB in Jordan and as a Laboratory engineer at Yarmouk University, Jordan. His research interests include Electric Motor Drives and electrostatic precipitators. He can be contacted at email: moath.banifayyad@gmail.com



Aysha Anagreh     has received her B.Sc. degree in Civil engineering / construction management from Yarmouk University, Irbid, Jordan in 2018 and her M.Sc. degree from Budapest University of Technology and Economics, Budapest, Hungary in 2019. She was working as a part time lecturer at both Yarmouk University and Al-Balqa' Applied University, Irbid, Jordan. She is currently applying to several US universities to pursue her Ph.D. study. Her research interests include structural engineering, construction materials, engineering education and algorithms-based engineering schemes. She can be contacted at email: aysha_yaser@yahoo.com