

Improving control quality of PMSM drive systems based on adaptive fuzzy sliding control method

Tran Duc Chuyen¹, Roan Van Hoa¹, Hoang Dinh Co¹, Tran Thi Huong¹, Pham Thi Thu Ha¹,
Bui Thi Hai Linh², Tung Lam Nguyen³

¹Faculty of Electrical, University of Economics and Technology for Industries, Ha Noi, Viet Nam

²Faculty of Electrical, Thai Nguyen University of Technology, Thai Nguyen, Viet Nam

³Department of Industrial Automation, School of Electrical and Electronic Engineering, Hanoi University of Science and Technology, Ha Noi, Viet Nam

Article Info

Article history:

Received Aug 11, 2021

Revised Mar 22, 2022

Accepted Apr 4, 2022

Keywords:

Card dSPACE 1104

Fuzzy adaptive sliding control

Intelligent control

Nonlinear control

Position control

ABSTRACT

In this paper, a solution to improve the precision in speed control for permanent magnet synchronous motors (PMSM) based on fuzzy adaptive sliding mode controller (FASMC) is proposed. In order to tackle the nonlinear tracking problem, continuously switching topologies are embedded. The designed algorithm and the closed electric drive system stability is examined by employing corresponding Lyapunov candidate functions. The results are numerically simulated and experimentally verified in the environment of MATLAB-Simulink, control Desk with dSPACE 1104 card, proving the applicability of the control algorithm which not only works well in simulations but also in practice for possible industrial traction drive applications.

This is an open access article under the [CC BY-SA](https://creativecommons.org/licenses/by-sa/4.0/) license.



Corresponding Author:

Tung Lam Nguyen

Department of Industrial Automation, School of Electrical and Electronic Engineering

Hanoi University of Science and Technology

Ha Noi, Viet Nam

Email: lam.nguyentung@hust.edu.vn

1. INTRODUCTION

For decades, permanent magnet synchronous motors (PMSM) are widely used in industrial applications. The drive provide high-quality speed adjustment applications such as electric vehicles, precise position control such as industrial robots, industrial machining machines, traction drive systems, military radar system, and rocket control systems. In addition, PMSM can be found in medication manufacturing, such as pill-packing machine in the pharmaceutical industry, equipment and machinery for supporting surgical operations in the field of medicine, due to its outstanding characteristics (wide and regularly stable working speed range: from very low speed to high speed, with a large moment/current ratio, less interference, stability with load, high performance, very high precision in position control). These PMSM motors are intended to replace the previous drive control systems (which have been using DC motors, causing errors at all times during speed control and position control), [1], [2]. In order to apply these given issues, an intelligent controller – fuzzy adaptive sliding mode controller (FASMC); is an efficient control method that has been widely applied to control for both linear and nonlinear systems [2]-[7].

In applications to precise control systems with various operating speed ranges such as traction systems in pharmaceutical industry (pill-packing machine); and strict requirement in metalworking industry, and in traction systems of military weapons, [5], [6], [8]-[10]. However, there exist some problems need to be

solved to improve the quality of control. In [4], [6] and [11]-[13], the authors have only recommended fuzzy control methods for PMSM without considering system uncertainties and external disturbances. In [14]-[17] the authors have used adaptive sliding controller and adaptive backstepping controller, with evaluation of the nonlinear component base on the estimators with light power motors hence limiting its practical implementation with high power requirements. This paper have proposed the FASMC to handle mismatched uncertainties and disturbances and alleviate chattering to gain good performances in the close-loop system [18]-[23].

The appropriate structure is designed in the paper to ensure quality in the controlled system. The control is constructed for achieving tracking response of drive systems. In electrical drives, it is necessary to provide quality criteria such as: fast-acting in the control process, ensuring optimization of control law, non-sensitivity to uncertainties in the control process, [1], [15]. This is a multi-objective optimization control problem with various solutions [1], [5], [9], [13], [21]. This paper presents a technique to improve the control quality PMSM in industrial applications; taking into account the nonlinear uncertainty, the dynamics of the actuator and the converters based on the adaptive fuzzy sliding control method, and experimenting with the dSPACE 1104 card to demonstrate the results, [3], [5], [8], [15], [24].

2. MATHEMATICAL MODEL OF PERMANENT MAGNET SYNCHRONOUS MOTORS

The mathematical model of the three-phase PMSM is described as in [4]. By considering the rotor coordinates of PMSM as the reference coordinates, the systems dynamic is represented by (1) [4], [8], [10]:

$$\begin{cases} \dot{\omega} = k_1 i_q - k_2 \omega - k_3 M_L \\ i_q = -k_4 i_q - k_5 \omega + k_6 V_q - \omega i_d \\ i_d = -k_4 i_d + k_6 V_d + \omega i_q \end{cases} \quad (1)$$

where M_L is the load torque, ω is the rotor angular speed, i_q and i_d are linearized d-axis and q-axis stator currents, V_q is q-axis voltage, R_s is stator resistance, V_d is d-axis voltage, and k_i , $i = 1 \dots 6$ are obtained as (2)-(6):

$$k_1 = \frac{3}{2} \frac{p^2}{J} \lambda_m, k_2 = \frac{B}{J}, k_3 = \frac{p}{2J}, k_4 = \frac{R_s}{L_s}, k_5 = \frac{\lambda_m}{L_s}, k_6 = \frac{1}{L_s} \quad (2)$$

$$V_q = R_s i_q + L_q \dot{i}_q + \omega L_d i_d + \omega \lambda_m \quad (3)$$

$$V_d = R_s i_d + L_d \dot{i}_d - \omega L_s i_q \quad (4)$$

$$M_e = \frac{3}{2} \frac{p}{2} [\lambda_m i_q + (L_d - L_q) i_d i_q] \quad (5)$$

$$M_e = M_L + B \frac{2}{p} \omega + J \frac{2}{p} \dot{\omega} \quad (6)$$

where M_e is electromagnetic moment, p is number of pole pairs, R_s is stator resistance, L_d is the d-axis stator inductance and L_q is the q-axis stator inductance, L_s is stator inductance, J is rotor moment of inertia, B is viscous friction coefficient, is λ_m linkage magnetic flux and $\omega = \dot{\theta}$; Hence, a nonlinear control loop of linearization methodology is used to estimate the θ , the rotor speed ω which are the unmeasured components of the motor. Furthermore, the presentation of the d-q reference axis coordinate system of the motor can be obtained as (7) and (8) [4].

$$\begin{bmatrix} v_d^e \\ v_q^e \\ 0 \\ 0 \end{bmatrix} = \begin{bmatrix} R_s + \sigma L_s p & -\sigma L_s \omega_e & \frac{L_m}{L_r} p & -\frac{L_m}{L_r} \omega_e \\ \sigma L_s \omega_e & R_s + \sigma L_s p & \frac{L_m}{L_r} \omega_e & \frac{L_m}{L_r} p \\ -L_m \frac{R_r}{L_r} & 0 & \frac{R_r}{L_r} + p & -\omega_{sl} \\ 0 & -L_m \frac{R_r}{L_r} & \omega_{sl} & \frac{R_r}{L_r} + p \end{bmatrix} \begin{bmatrix} i_d^e \\ i_q^e \\ \phi_d^e \\ \phi_q^e \end{bmatrix} \quad (7)$$

$$M_e = \frac{3}{2} \frac{n}{2} \frac{L_m}{L_r} (i_q^e \phi_d^e - i_d^e \phi_q^e) \quad (8)$$

In the field oriented control (FOC) method, the magnetic flux is oriented completely along d -axis implying $\phi_q^e = 0$ and we get:

$$\phi_r^e = \phi_d^e \quad (9)$$

then the slip speed is represented as (10).

$$\omega_{sl} = \frac{L_m}{\phi_r^e} \left(\frac{R_r}{L_r} \right) i_q^e \quad (10)$$

The electromagnetic torque is obtained as in (11):

$$M_e = \frac{3}{2} \frac{n}{2} \frac{L_m^2}{L_r} i_q^* i_d^* = K_t i_q^* \quad (11)$$

in which:

$$K_t = \frac{3}{2} \frac{n}{2} \frac{L_m^2}{L_r} i_d^* \quad (12)$$

the mathematical equation describing the equations of motion of the motor is written as (13):

$$J \dot{\omega}_r(t) + B \omega_r(t) = M_e + M_L \quad (13)$$

where J_r is rotor moment of inertia, B is viscous friction coefficient, M_L is load moment, by replacing (11) and (12) into (13), derivative of rotor speed $\dot{\omega}_r(t)$ is given as (14):

$$\dot{\omega}_r(t) = -\frac{B}{J_r} \omega_r(t) + \frac{K_t}{J_r} i_q^* - \frac{M_L}{J_r} = B_p \omega_r + A_p i_q^* + D_p M_L \quad (14)$$

in which, $B_p = -B/J_r < 0$; $A_p = K_t/J_r > 0$; $D_p = -1/J_r < 0$. In order to obtain a mathematical model that is suitable for control design, the nominal value of the motor parameters must be considered when ignoring influencing factors of nonlinear components and unaffected by any disturbances [13], [14], [17], [19]. Therefore, the kinematic model of the PMSM that given by (14) becomes (15):

$$\dot{\omega}_r(t) = \bar{B} \omega_r(t) + \bar{A} i_q^{*e} \quad (15)$$

where, $\bar{A} = \bar{K}_t/\bar{J}_r$ and $\bar{B} = -\bar{B}/\bar{J}_r$ are the nominal values of A_p and B_p , respectively. Therefore, the computations of unmodeled system in the (14) can be rewritten as:

$$\dot{\omega}_r(t) = (\bar{B} + \Delta B) \omega_r(t) + (\bar{A} + \Delta A) i_q^{*e} + D_p M_L + \delta = \bar{B} \omega_r(t) + \bar{A} i_q^{*e} + L(t) \quad (16)$$

where, $L(t) = \Delta B \omega_r(t) + \Delta A i_q^{*e} + D_p M_L + \delta$. In (16), the unknown parameters are represented by ΔA and ΔB ; characteristics for the system containing the uncertainty components including the variable parameter and the nonlinear estimation error which are unmeasurable components. In addition, these parameters are the unchangeable depend on the dynamics of the system, so in order to simplify the analysis, calculation and estimation of parameters in the paper, the above parameters are assumed to be constant and is denoted as δ . In the above question, $L(t)$ is the unknown components satisfying $|L(t)| < m$, where m is a positive constant.

3. FUZZY ADAPTIVE SLIDING MODE CONTROLLER DESIGN

3.1. Conventional sliding mode controller

Sliding mode control offers many advantages in the synthesis of nonlinear control system [5], [8], [12], due to invariance to disturbances on the system and unknown components; the order of the system is decreased when the the system in on the sliding surface. We consider the change of speed adjustment error, $e(t) = \omega_r(t) - \omega_r^*(t)$, thus, in the sliding mode with the space state, $S(t)$ can be obtained as:

$$S(t) = h(Ce(t) + \dot{e}(t)) \quad (17)$$

in which, C and h are positive constants, substituting (16) into (17), with the first derivative of $S(t)$ taking the following form:

$$\dot{S}(t) = h(C\dot{e}(t) + \bar{B}\dot{\omega}_r(t) + \bar{A}\dot{u}(t) + \dot{L}(t) - \dot{\omega}_r^*(t)) \quad (18)$$

in which, $u(t) = i_q^e(t)$. Setting, $\dot{S}(t) = 0$ and $\dot{L}(t) = 0$, then according to the system dynamics, the equivalent control is defined as, [1, 4, 5, 9, 20].

$$u_{eq}(t) = -(\bar{A})^{-1}[(C + \bar{B})\dot{e}(t) + \bar{B}\dot{\omega}_r^*(t) - \ddot{\omega}_r^*(t)] \quad (19)$$

Then the reaching law $u_r(t)$ is designed as:

$$u_r(t) = -(\bar{A}h)^{-1}k(t)\text{sign}(S(t)) \quad (20)$$

in which, $k(t) > 0$ and the “sign” function are defined as follows:

$$\text{sign}(S(t)) = \begin{cases} 1, & \text{if } S(t) > 0 \\ -1, & \text{if } S(t) < 0 \end{cases} \quad (21)$$

The controller is achieved when considering the unmodeled actuator dynamics, which can be defined as following:

$$u(t) = u_{eq}(t) + u_r(t) \quad (22)$$

$$i_q = \frac{1}{\tau} \int_0^t u(t) dt \quad (23)$$

in which, τ is the integral positive constant. According to the designed control, a control Lyapunov function (CLF) candidate is chosen in (24):

$$V(t) = \frac{1}{2}S^2(t) \quad (24)$$

the stability condition showing the stability can be obtained from the stability theorem of the Lyapunov function of [1], [5], [8].

$$\dot{V}(t) = S(t) \cdot \dot{S}(t) \leq \eta|S(t)| \quad (25)$$

Where η is a positive constant. From (18), (19) and (22), (25), it can be rewritten as:

$$\begin{aligned} \dot{V}(t) &= S(t) \cdot \dot{S}(t) = -S(t)h\bar{A}u_r(t) + hS(t)\dot{L}(t) \\ \dot{V}(t) &\leq -k|S(t)| + h|S(t)||\dot{L}(t)| \Rightarrow \dot{V}(t) \leq -|S(t)|(k(t) - hm) \end{aligned} \quad (26)$$

compare (25) and (26) then consider $|\dot{L}(t)| < m$, the stability of the system is guaranteed if the following equation is fulfilled:

$$k(t) \geq hm + \eta \quad (27)$$

In practical applications, we may experience undesirable phenomenon of oscillations especially when η is large respectively. The chattering phenomenon can be reduced by replacing the discontinuous function with a continuous function of approx $s/(|s| + \mu)$, in which, μ is a positive constant. Thus, when $\mu \rightarrow 0$ the approximate controller characteristic which is approached to the original controller as well [5], [14]. A nonlinear state observer to accurately estimate the position and speed of the motor with the influence of unmeasured component parameters in both low and high speed regions control is used in the paper. The design procedure of the nonlinear state observer has been carefully presented in [21]. This nonlinear state observer is used to estimate the rotor position (θ), rotor speed (ω), load torque component (M_L) and unmeasured component of the system (d_1, d_2), [25], [26].

3.2. Fuzzy adaptive sliding mode controller

In this paper, we investigated the fuzzy adaptive sliding mode controller for the disturbance observer control tracking approach of the PMSM driven system. In field-oriented control (FOC), stator field is continuously updated based on the position of the rotor field, since position and speed of the motor are estimated based on current and voltage information. thus, a nonlinear state estimator which is estimated accurately of the rotor is implemented as well. The block diagram of the FASMC system is shown in the Figure 1, which in speed loop control, the stator current i_q^e represents its output. The independent control of I_{ds} and I_{qs} consists of two PI regulators. In the present implementation, the rotor position measurement is

derived from an angle sensor. Chattering can be eliminated by smoothing the control discontinuity when the signum function in (20) is replaced by the saturation action which is represented as:

$$sat\left(\frac{S}{\psi}\right) = \begin{cases} sign(S), & \text{when } |S| > |\psi| \\ \frac{S}{\psi}, & \text{when } |S| \leq |\psi| \end{cases} \tag{28}$$

in which, ψ is the thickness of layer of the sliding surface. Thus, the discontinuous component control is given by (20) becomes (29).

$$u_r(t) = -(\bar{A}h)^{-1}k(t)sat(S(t)/\psi) \tag{29}$$

to deals with the unknown of the motor mechanical load, fuzzy control strategy is an effective tool to deal with the unknown process. The control variable u_{TMTN} of FASMC algorithm is proposed as (30).

$$u_{TMTN} = TMTN(S(t), \Delta S(t)) \tag{30}$$

Subsequently the reaching law and control law are defined as (31) and (32).

$$u_r(t) = -(\bar{A}h)^{-1}k(t)u_{TMTN} \tag{31}$$

$$u(t) = u_{eq} - (\bar{A}h)^{-1}k(t)u_{TMTN} \tag{32}$$

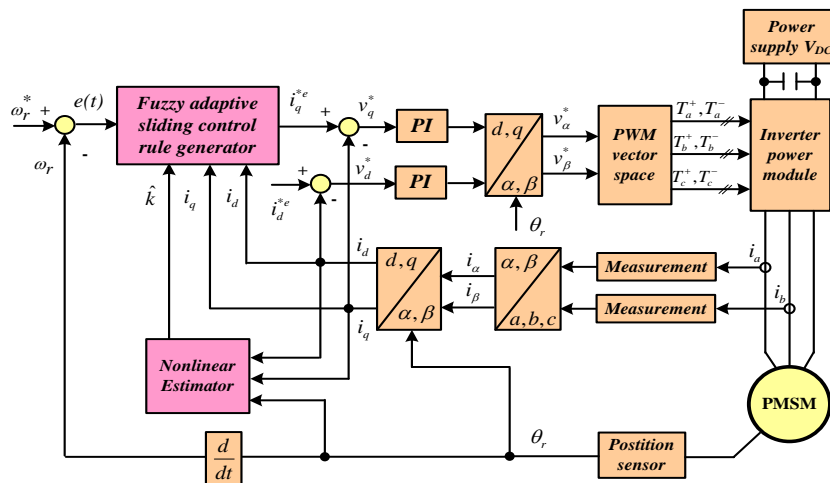

Figure 1. Block diagram of control structure of the drive system using PMSM based on FASMC

Because the plant is lack of an integral action, a PI type fuzzy controller is formulated. Additionally, refer to [8], [14], we can build the structure of the FASMC which is shown in the Figure 1. The fuzzy controller consists of: two input linguistic variables which are error $S(t)$, and the error derivative $\Delta S(t)$; one output linguistic variable U_{TMTN} . The FASMC structure is depicted in Figure 2 and the fuzzy rule is presented as in Table 1. Inputs and output relationship of the fuzzy controller is as shown in Figures 3-5 and Figure 6 the relationship of the fuzzy controller. It is pivotal to minimize $L(t)$ which is given in (26). In order to estimate $k(t)$ given in (30) we using the corresponding adaptation law presented in (33) [8].

$$\dot{k}(t) = \lambda_k |S(t)| \tag{33}$$

In which, λ_k is a positive constant. In fact, $k(t)$ is as an adaptive filter to minimize control errors.

$$\dot{k}(t) = \lambda_k |S(t)| \tag{33}$$

Consider the following Lyapunov candidate function:

$$V(t) = \frac{1}{2}S(t)^2 + \frac{1}{2\lambda_k}(k(t) - \hat{k})^2 \tag{34}$$

substitute (18) and (34) for (25) to get $|S(t)| < \psi(t)$ as (35).

$$\begin{aligned} \dot{V}(t) &= S(t)h(\bar{A}u_r(t) + \dot{L}(t)) + \frac{1}{\lambda_k}(k(t) - \hat{k})\dot{k}(t) = S(t)h(-\bar{A}k(t)(h\bar{A})^{-1} \operatorname{sgn}(S) + \dot{L}(t)) + \\ &+ \frac{1}{\lambda_k}(k(t) - \hat{k})\dot{k}(t) = -S(t)k(t) \operatorname{sgn}(S) + hS(t)\dot{L}(t) + \frac{1}{\lambda_k}(k(t) - \hat{k})\dot{k}(t). \end{aligned} \quad (35)$$

Substitute (33) for (35) and alter (25), we get (36).

$$\begin{aligned} \dot{V}(t) &\leq |k(t) - \hat{k} - \hat{k}|S(t)| + h|\dot{L}(t)||S(t)| + |k(t) - \hat{k}||S(t)| \\ &< -|k(t) - \hat{k}||S(t)| - \hat{k}|S(t)| + hm|S(t)| + |k(t) - \hat{k}||S(t)| < (-\hat{k} + hm)|S(t)| \end{aligned} \quad (36)$$

Compare (25) and (36), we get (37).

$$\dot{V}(t) < (-\hat{k} + hm)|S(t)| \leq \eta|S(t)| \quad (37)$$

Table 1. The rule base of fuzzy controller

u_{TMN}	$S(t)$					
	AL	AV	K	DV	DL	
$\Delta S(t)$	GN	AL	AN	AV	K	DV
	GV	AL	AV	AV	K	DV
	H	AL	AV	K	DV	DL
	TV	AV	K	DV	DV	DL
	TN	AV	K	DV	DL	DL

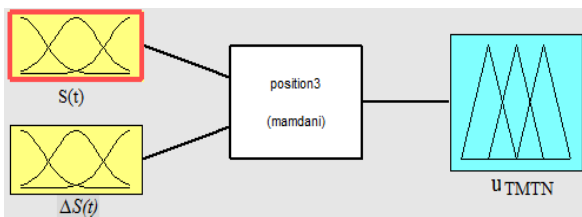

Figure 2. Fuzzy controller structure

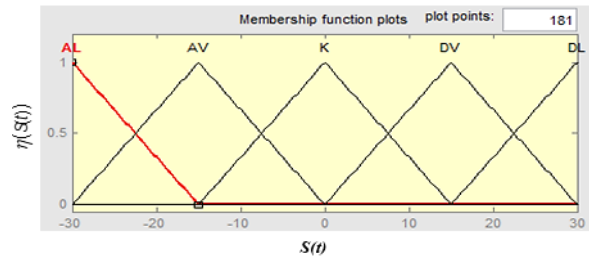

Figure 3. Membership function of fuzzy controller input $S(t)$

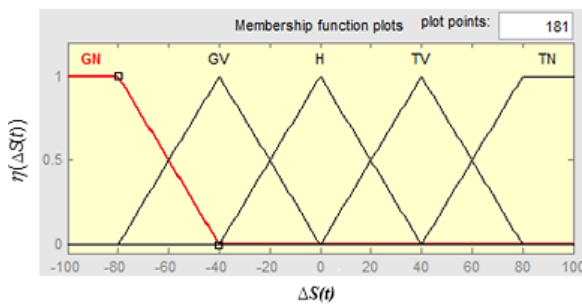

Figure 4. Membership function of fuzzy controller input $\Delta S(t)$

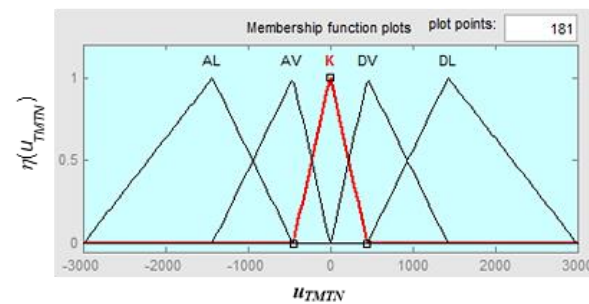

Figure 5. Membership function of fuzzy controller output u_{TMN}

Therefore, the component k can be selected such that $-\hat{k} + mh + \eta$ is negative. It is straight forward to have $-\hat{k} \geq +mh + \eta$. In this paper, by applying the proposed adaptive fuzzy sliding controller along with the designed fuzzy rules and the mentioned conditions, the system stability condition in (25) is satisfied. In practical, the factors of frictional moment, elasticity, and clearance. always exist in the electro-mechanical drive system including motor and working structure. By using the proposed FASMC, the effects of the nonlinear factors on the quality of the drive system have been resolved [14]-[16].

Parameters V_p, V_I are chosen based on Zeigler - Nichols experimental method. After choosing parameters V_p, V_I , we can calculate parameters V_p and d . However, due to experimental method, in order to improve control quality: short transient time and small overshoot since two parameters V_p and d need to be adjusted furtherly. Parameters is set: $V_p=0.01$; $d=0.99$ (with $T=0.002$). The quality of the PI controller after calculating the selection, we obtain: $K_p=0.3$; $K_I=0.0001$. The PID-controller design process is considered in [1], [14], [17], [18], [19].

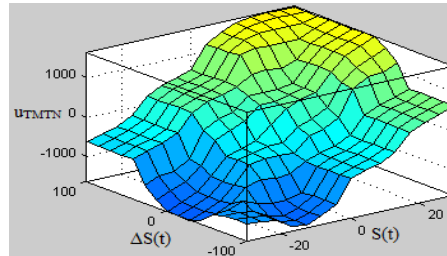

Figure 6. The relationship of the fuzzy controller

4. SIMULATION AND EXPERIMENTAL RESULTS

The Simulation and experimental results of FASMC are shown as following. The parameters of PMSM parameters are: Power $P=2.1$ kW; rated speed 3000 rpm; voltage $U=315$ V; rated current $I=4.4$ A; number of poles $2p=8$; static torque $M_0=8.0$ Nm; Rated torque $M_{dm}=6.8$ Nm; coefficient of viscous friction $B=0.0001$ N.m.s/rad; moment of inertia $J=14200$ kgcm²; maximum speed 6000 rpm; Simulation results is presented in the following cases.

- Case 1: Simulation of evaluation the system’s working ability when the speed changes with amplitude of 1000 rpm to-1000 rpm, the load moment changes in sinusoidal form, the load torque is 0.5 Nm which shows in Figure 7 to Figure 10. Where M is the loading torque, M (Obs) is the observed torque.
- Case 2: The motor speed with amplitude of 50 rpm and 0.5 rpm is examined to test the system ability in low speed range. The responses are shown in Figure 11 to Figure 14.
- Case 3: The system's response when when reference position is set according $X_v=Vt$, ($V=1$ rad/s) constant load moment $M_c=0,5$ Nm that shown in Figure 15 and Figure 16.

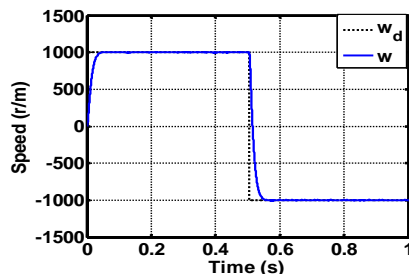

Figure 7. Response speed ω_d and actual speed ω of motor in case 1

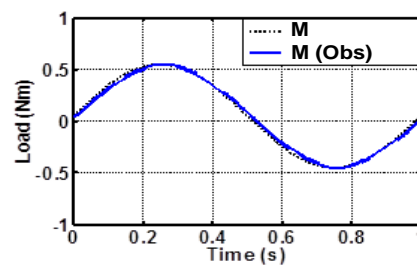

Figure 8. Response torque and estimated torque in case 1

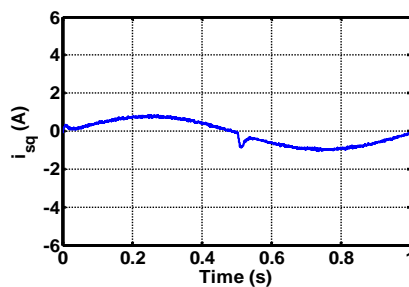

Figure 9. Current response i_q in Case 1

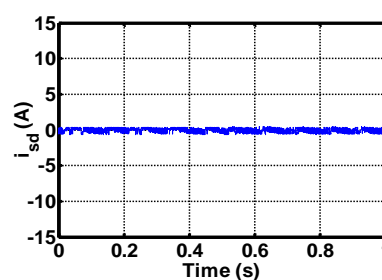

Figure 10. Current response i_d in case 1

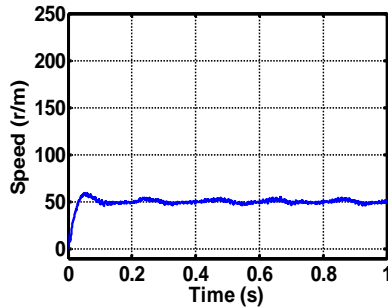

Figure 11. Response speed ω_d and actual speed ω of motor in case 2

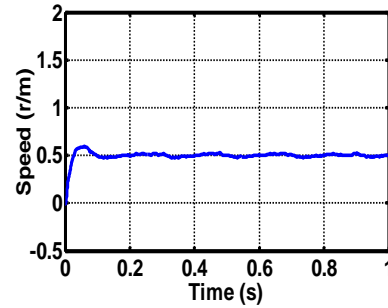

Figure 12. Response set speed ω_d and actual speed ω of the working mechanism case 2

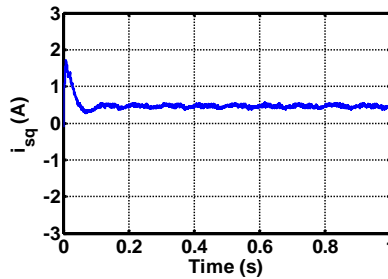

Figure 13. Current response i_q in case 2

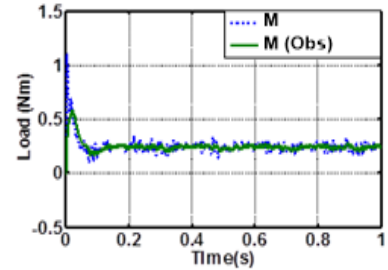

Figure 14. Response torque and estimated torque in case 2

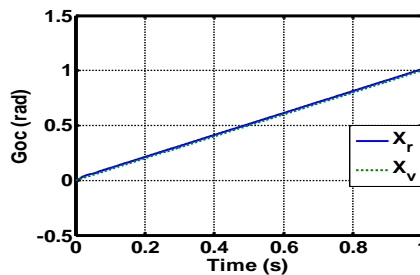

Figure 15. Controller input/output response in radian in case 3

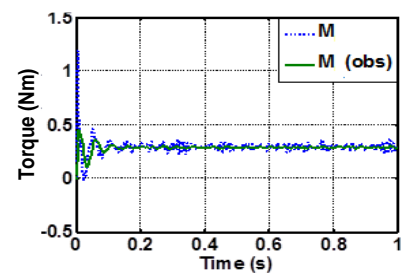

Figure 16. Controller input/output response in torque in case 3

The simulation results of some cases shows that the FASMC is proposed with the sustainability, stability of the control law against the effects of unknown parameters which will change the transition time, increase the fast response of the system. Moreover, in the transient mode, the application of proposed controller given a good performance response as well.

The experimental structure diagram as shown in Figure 17(a) and the experimental system in real time is depicted in Figure 17(b) with its designed, built and simulated on MATLAB Simulink's 2021 and connected to the control board dSPACE 1104 with a combination of graphical control desk software in controlling; observe system characteristics in real time. Combined with power electronics, and current measurement sensors connected to the dSPACE panel. The PMSM motor parameters used in the experiment are the same as those used in simulations, encoder AM 2048 S/R, DC motor used to generate loads, symbol DOLIN - SH.198V with voltage $U=190$ V, $I=13.5$ A, $n=175$ rpm.

Studying the process of changing low speed from 50 rad/s (478 rpm) to -50 rad/s (-478 rpm), timing the conversion is 2.5s in the total response time of 5s, Figure 18. The results show that the FASMC controller response is working well, the output is close to the input in the balance process, the current response value I_d and I_q in Figure 19 shows the correct working process of the system.

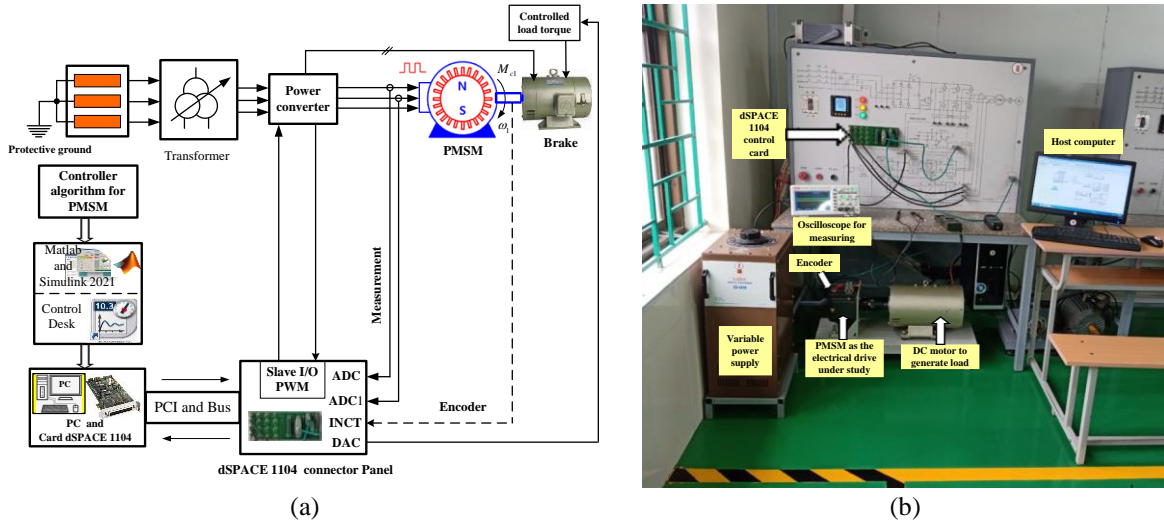

Figure 17. The overall system in experimental: (a) control diagrams and (b) the experimental system

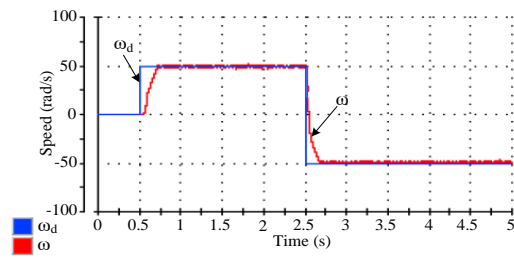

Figure 18. The experimental response by changing speed from 50 rad/s to -50 rad/s speed

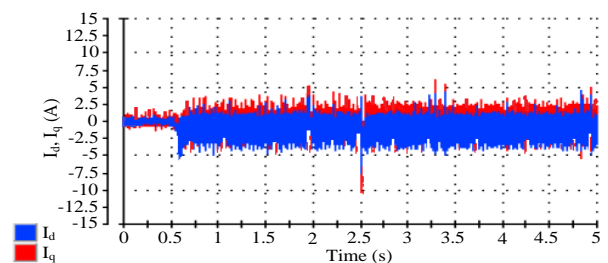

Figure 19. The experimental results with current values I_d and I_q

5. CONCLUSION

The traction drive system in industry applications needs very high reliability and accuracy. The paper presented a new approach, researched and built an adaptive FASMC for industrial traction drive systems. The main effectiveness of this method is that the robustness of the system is introduced. The second advantage of the proposed FASMC is that the chattering phenomenon is significantly reduced. Theoretical research and simulation results show that the proposed FASMC algorithm for PMSM which achieves good quality and more stable operation. The results of simulation and experimental studies with the dSPACE 1104 card show that the above control algorithm exhibits good dynamical responses when compared to other works. This study has proven the correctness of the FASMC algorithm which has ability to apply in practice to the traction electric drive systems.

ACKNOWLEDGEMENTS

This research was supported by Faculty of Electrical Engineering, University of Economics-Technology for Industries, Viet Nam.



REFERENCES

- [1] A. Bacciotti, "Stability and Control of Linear Systems," Springer Nature Switzerland AG, 2019, doi: 10.1007/978-3-030-02405-5.
- [2] A. Emadi, "Advanced Electric Drive Vehicles," CRC Press is an imprint of Taylor & Francis Group, an Informa business, Springer International Publishing; USA, 2017, doi: 10.1201/9781315215570.
- [3] M. Jufer, "Electric Drives," John Wiley & Sons, Inc London, Feb. 2013. doi: 10.1002/9781118622735.
- [4] J. Connor and S. Laflamme, "Advanced control theory," Springer International Publishing Switzerland, May 2014, doi: 10.1007/978-3-319-06281-5_10.
- [5] E. Gelenbe and I. Mitrani, "Analysis and Synthesis of Computer Systems," Publisher: Imperial College Press, 2010, doi: 10.1142/p643
- [6] M. Steinberger, M. Horn, and L. Fridman, "Variable-Structure Systems and Sliding-Mode Control from theory to practice," Springer nature Switzerland, 2020, doi: 10.1007/978-3-030-36621-6.



- [7] L. Keviczky, R. Bars, J. Hetthéssy and C. Bányász, "Control Engineering: MATLAB Exercises," *Springer Nature Singapore Pte Ltd*, USA, 2019, doi: 10.1007/978-981-10-8321-1_1.
- [8] N. P. Quang and J-A. Dittrich, "Vector control of three-phase AC machines – System development in the practice. 2nd edition," *Springer-Verlag Berlin Heidelberg*, 2015, doi: 10.1007/978-3-662-46915-6.
- [9] J. M. Lazi, Z. Ibrahim, M. Talib, A. Alias, A. Nur and M. Azri, "Speed and position estimator of for sensorless PMSM drives using adaptive controller," *International Journal of Power Electronics and Drive Systems*, vol. 10, no. 1, march 2019, pp. 128-136m, doi: 10.11591/ijpeds.v10.i1.pp128-136.
- [10] J. Chiasson, "Modeling and high performance control of electric machines," *Wiley-IEEE Press*, 2005, doi: 10.1002/0471722359.
- [11] J. Pyrhöönen, V. Hrabovcová and S. R. Semken, "Electrical Machine Drives Control," *Wiley-IEEE Press*, 2016, doi: 10.1002/9781119260479.
- [12] A. Bartoszewicz and R. J. Patton, "Sliding mode control," *International Journal of Adaptive Control and Signal Processing*, vol. 21, no. 8-9, pp. 635-637, 2007, doi: 10.1002/acs.996.
- [13] V. Utkin, J. Guldner and J. Shi., "Sliding Mode Control in Electro-Mechanical Systems," *CRC Press LLC*, 2017, doi: 10.1201/9781420065619.
- [14] H. H. Choi and J. W. Jung, "Fuzzy speed control with an acceleration observer for a permanent magnet synchronous motor," *Nonlinear Dynamics*, vol. 67, no. 3, pp. 1717-1727, 2012, doi: 10.1007/s11071-011-0099-y.
- [15] V. Q. Leu, H. H. Choi and J. Jung, "Fuzzy Sliding Mode Speed Controller for PM Synchronous Motors With a Load Torque Observer," in *IEEE Transactions on Power Electronics*, vol. 27, no. 3, pp. 1530-1539, March 2012, doi: 10.1109/TPEL.2011.2161488.
- [16] H. Choi, J. W. Jung and T. H. Kim, "Digital Speed Regulator System Design for a Permanent Magnet Synchronous Motor," *J Electr Eng Technol*, vol. 7, no. 6, pp. 911-917, 2012, doi: 10.5370/JEET.2012.7.6.911.
- [17] O. Boughazi, A. Boumediene and H. Glaoui, "Sliding Mode Backstepping Control of Induction Motor," *International Journal of Power Electronics and Drive Systems (IJPEDS)*, vol. 4, no. 4, pp. 481-488, 2014, doi: 10.11591/ijpeds.v4.i4.
- [18] M. Zaky, E. Touti and H. Azazi, "Two-Degrees of Freedom and Variable Structure Controllers for Induction Motor Drives," *Advances in Electrical & Computer Engineering*; vol. 18, no. 1, pp. 71-80, 2018, doi: 10.4316/AECE.2018.01009.
- [19] S. Kim, K. Lee and K. Lee, "Singularity-Free Adaptive Speed Tracking Control for Uncertain Permanent Magnet Synchronous Motor," in *IEEE Transactions on Power Electronics*, vol. 31, no. 2, pp. 1692-1701, Feb. 2016, doi: 10.1109/TPEL.2015.2422790.
- [20] V. T. Ha, N. T. Lam, V. T. Ha and V. Q. Vinh, "Advanced control structures for induction motors with ideal current loop response using field oriented control," *International Journal of Power Electronics and Drive Systems (IJPEDS)*, vol. 10, no. 4, pp. 1758-1771, Dec. 2019, doi: 10.11591/ijpeds.v10.i4.
- [21] T. D. Chuyen, D. Q. Hiep and D. H. Du, "Research to Improve the Quality Control for Drive System Tracking Electromechanical Takes into Account Nonlinear Undetermined Application in Industrial Production," *Advances in Engineering Research and Application*, 2021, pp. 708-723, doi: 10.1007/978-3-030-64719-3_77.
- [22] A. Akpunar and S. Iplikci, "Runge-Kutta Model Predictive Speed Control for Permanent Magnet Synchronous Motors," *Energies*, vol. 13, no. 5, pp. 1-17, doi:10.3390/en13051216.
- [23] J. Zhang, P. Shi and Y. Xia, "Robust Adaptive Sliding-Mode Control for Fuzzy Systems With Mismatched Uncertainties," in *IEEE Transactions on Fuzzy Systems*, vol. 18, no. 4, pp. 700-711, Aug. 2010, doi: 10.1109/TFUZZ.2010.2047506.
- [24] H. H. Choi, J. W. Jung and R.- Y. Kim, "Fuzzy adaptive speed control of a Permanent Magnet Synchronous Motor," *International Journal of Electronics*, vol. 99, no. 5, pp. 657-672, doi: 10.1080/00207217.2011.643494.
- [25] R.-J. Wai and K.-H. Su, "Adaptive enhanced fuzzy sliding-mode control for electrical servo drive," in *IEEE Transactions on Industrial Electronics*, vol. 53, no. 2, pp. 569-580, April 2006, doi: 10.1109/TIE.2006.870710.
- [26] C. Sindhura and K. V. S. M. Babu, "Sensorless Control of PMSM Using dSPACE Controller," *International Journal of Pure and Applied Mathematics*, vol. 118, no. 14, pp. 579-584, 2018.

BIOGRAPHIES OF AUTHORS





Tran Duc Chuyen    received the Ph.D degree in Industrial Automation from Le Qui Don Technical University (MTA), Hanoi, Vietnam in 2016. Now, works at Faculty of Electrical Engineering, University of Economics - Technology for Industries. He is currently the President of Council the Science of Faculty of Electrical Engineering. Dr Tran Duc Chuyen's main researches: Electric machine, drive system, control theory, power electronics and application, adaptive control, neural network control, automatic robot control, motion control, artificial intelligence. He can be contacted at email: tdchuyen@uneti.edu.vn.





Roan Van Hoa    Graduated Engineering Degree major in Electronic Engineering at Thai Nguyen University of Technology in 2008. Defensed Master Degree in Control Engineering and Automation at Thai Nguyen university of technology, Vietnam in 2011. Now, works at Department of Electrical Engineering, University of Economics - Technology for Industries. The main researches: Adaptive control, fuzzy logic control, neural network control, artificial intelligence. He can be contacted at email: rvhoa@uneti.edu.vn.





Hoang Dinh Co    was born in Nam Dinh. He graduated as an Engineer in Automation at Thai Nguyen University of Technology and Industry in 2002. He graduated with a Master of Science in Control and Automation from Hanoi University of Science and Technology, Vietnam in 2013. Since 2000, he is a lecturer at the Faculty of Electrical Engineering, University of Economics - Industrial Technology; Ministry of Industry and Commerce Vietnam. Main research direction: intelligent control, fuzzy control and neural network. He can be contacted at email: hdco@uneti.edu.vn.





Tran Thi Huong    was born in Nam Dinh. She graduated in Electronic Engineering from Le Quy Don University of Technology, Hanoi, Vietnam in 2009. Currently working at the Faculty of Electronics, University of Economics - Industrial Technology. Tran Thi Huong's Main Research: electronic engineering, telecommunications engineering, information technology, automated robots, artificial intelligence, control applications, neron control networks. You can contact us at email: huongtt@uneti.edu.vn.





Pham Thi Thu Ha    was born in Nam Dinh. She graduated with a master's degree in Electronic Education from the University of Technology, Hanoi, Vietnam in 2010. Currently working at the Faculty of Electronics, University of Economics - Industrial Technology. Pham Thi Thu Ha's main research: Electronic engineering, Electronics applied in industry, wireless sensor network, internet of things (IoT), telecommunications network. You can contact us at the email address: ptha@uneti.edu.vn.



Bui Thi Hai Linh    was born in Thai Nguyen city, Vietnam. She graduated with a master's degree in Electrical Engineering from the Southern Taiwan University of Science and Technology, Taiwan in 2011 and doctoral's degree in the same school in 2015. Currently she working at the Faculty of Electrical Engineering, Thai Nguyen University of Technology, Thai Nguyen, Vietnam. Ph.D Bui Thi Hai Linh main researches: control engineering and automation, robotics, PLC in Industry, application of FPGA. You can contact us at email: hailinh311@gmail.com.



Tung Lam Nguyen    received the B.S degree in Control and Automation Engineering from Hanoi University of Science and Technology, Hanoi, Vietnam, 2005, the M.S degree from Asian Institute of Technology, 2007, and the Ph.D from The University of Western Australia, 2014. He is current working as a lecturer at Department of Industrial Automation, School of Electrical Engineering, Hanoi University of Science and Technology. He is currently appointed as an Associate Professor in Control Engineering and Automation at Hanoi University of Science and Technology. His research interests include motion control, control system and its applications, artificial intelligence. He can be contacted at email: lam.nguyentung@hust.edu.vn.