

Relay Technical Information

CONFIGURATION AND CONSTRUCTION

PROTECTIVE CONSTRUCTION

1. Dust Cover Type

To protect from dust, these types are covered, for example, with a plastic case. We recommend hand soldering, because these relays are not constructed to prevent flux and cleaning fluid from entering during automatic soldering.

2. Flux-Resistant Type

The relay is constructed so that flux will not enter inside the relay during automatic soldering. However, cleaning is not possible.

3. Sealed Type

Construction is designed to prevent seeping of flux when soldering and

cleaning fluid when cleaning. Harmful substances on the contacts are removed by gas purging before sealing with.

4. Sealed capsule type

This type is hermetically sealed with ceramic and metal plating. No harmful gas or humidity will ever reach the contacts. This type cannot be washed.

CONSTRUCTION AND CHARACTERISTICS

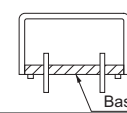
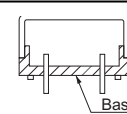
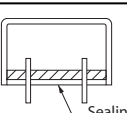
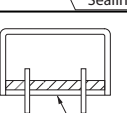
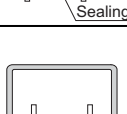
Type	Construction	Characteristics	Automatic Soldering	Automatic Cleaning	Dust Resistance	Harmful Gas Resistance
Dust Cover Type		Most basic construction where the case and base (or body) are fitted together.	Take care	No	Take care	No
Flux-Resistant Type		Terminals are sealed or molded simultaneously. The joint between the case and base is higher than the surface of the PC board.	Yes	No	Take care	No
		Terminals, case, and base are filled with sealing resin.	Yes	No	Take care	No
Sealed Type		Sealed construction with terminals, case and base sealed shut with sealing resin.	Yes	Yes	Yes	Yes*
Sealed capsule type (EP and EV relays only)		Hermetically sealed construction by sealing the metal case and plate, and the terminal and ceramic part, with solder.	No	No	Yes	Yes

*Since the plastic breathes, please do not use in an atmosphere that contains silicone.

OPERATIONAL FUNCTION

1. Single Side Stable Type

Relay which turns on when the coil is energized and turns off when de-energized.

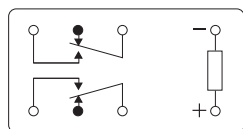

(Schematic example: DS relay)

2. 1 Coil Latching Type

Relay with latching construction that can maintain the on or off state with a pulse input. With one coil, the relay is set or reset by applying signals of opposite polarities.

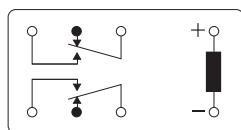

(Schematic example: DS relay)

3. 2 Coil Latching Type

Relay with latching construction composed of 2 coils: set coil and reset coil. The relay is set or reset by alternately applying pulse signals of the same polarity.

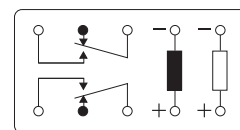

Schematic example: DS relay

Configuration and Construction

4. Operation Indication

Indicates the set and reset states either electrically or mechanically for easy maintenance. An LED type (HC relay with LED) is available.



LED type, HC relay

TERMINAL CONFIGURATION

Type	PC board through hole terminal	PC board self-clinching terminal	Plug-in terminal	Quick connect terminal	Screw terminal
Typical relay					
Terminal configuration					
Typical relay type	GQ(AGQ), TX, DS relay	TQ relay	HJ, HN relay	LE, LF, JM relay	HE, EP relay

Note:

A plug-in solder dual type (HG relay) is also available.

MOUNTING METHOD

Type	Insertion mount	Socket mount	Terminal socket mount	TM type	TMP type
Mounting configuration					
Typical relay type	TQ, DS, S relay	NC, HC relay	SP-, HC-, HJ-, HL-, JW-, SFS-Relays	HC relay	LE, LF relay



Notes:

- Sockets are available for certain PC board relays (S relay, ST relay).

DEFINITION OF RELAY TERMINOLOGY

COIL (also referred to as primary or input)

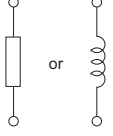
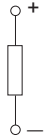
1. Coil Designation

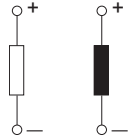
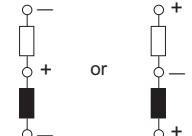
Single side stable type		1 coil latching type	2 coil latching type	
Non-polarized	Polarized		4-terminal	3-terminal
				

A black coil represents the energized state. For latching relays, schematic diagrams generally show the coil in its reset state. Therefore, the coil symbol is also shown for the reset coil in its reset state.

2. Nominal Coil Voltage

(Rated Coil Voltage)

A single value (or narrow range) of source voltage intended by design to be applied to the coil or input.

3. Nominal Operating Current

The value of current flow in the coil when nominal voltage is impressed on the coil.

4. Nominal Operating Power

The value of power used by the coil at nominal voltage. For DC coils expressed in watts; AC expressed as volt amperes. Nominal Power (W or VA) = Nominal Voltage × Nominal Current.

5. Coil Resistance

This is the DC resistance of the coil in DC type relays for the temperature conditions listed in the catalog. (Note that for certain types of relays, the DC resistance may be for temperatures other than the standard 20°C 68°F.)

6. Pick-Up Voltage

(Pull-In Voltage or Must Operate Voltage)

As the voltage on an unoperated relay is increased, the value at or below which all contacts must function (transfer).

7. Drop-Out Voltage

(Release or Must Release Voltage)

As the voltage on an operated relay is decreased, the value at or above which all contacts must revert to their unoperated position.

8. Maximum Continuous Voltage

The maximum voltage that can be applied continuously to the coil without causing damage. Short duration spikes of a higher voltage may be tolerable, but this should not be assumed without first checking with the manufacturer.

CONTACTS (secondary or output)

1. Contact Forms

Denotes the contact mechanism and number of contacts in the contact circuit.

2. Contact Symbols

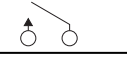
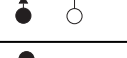
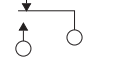
Form A contacts (normally open contacts)	
Form B contacts (normally closed contacts)	
Form C contacts (changeover contacts)	

Form A contacts are also called N.O. contacts or make contacts.

Form B contacts are also called N.C. contacts or break contacts.

Form C contacts are also called changeover contacts or transfer contacts.

3. MBB Contacts

Abbreviation for make-before-break contacts. Contact mechanism where Form A contacts (normally open contacts) close before Form B contacts open (normally closed contacts).

4. Rated Switching Power

The design value in watts (DC) or volt amperes (AC) which can safely be

switched by the contacts. This value is the product of switching voltage x switching current, and will be lower than the maximum voltage and maximum current product.

5. Maximum Switching Voltage

The maximum open circuit voltage which can safely be switched by the contacts. AC and DC voltage maximums will differ in most cases.

6. Maximum Switching Current

The maximum current which can safely be switched by the contacts. AC and DC current maximums may differ.

7. Maximum Switching Power

The upper limit of power which can be switched by the contacts. Care should be taken not to exceed this value.

8. Maximum Switching Capacity

This is listed in the data column for each type of relay as the maximum value of the contact capacity and is an interrelationship of the maximum switching power, maximum switching voltage, and maximum switching current. The switching current and switching

voltage can be obtained from this graph. For example, if the switching voltage is fixed in a certain application, the maximum switching current can be obtained from the intersection between the voltage on the axis and the maximum switching power.

Maximum switching capacity

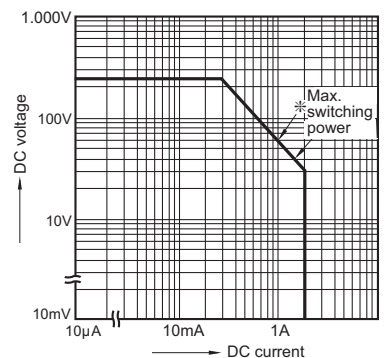

Example: Using TX relay at a switching voltage of 60V DC, the maximum switching current is 1A.

(*Maximum switching capacity is given for a resistive load. Be sure to carefully check the actual load before use.)

Definition of Relay Terminology

9. Minimum switching capability

This value is a guideline as to the lowest possible level at which it will be possible for a low level load to allow switching. The level of reliability of this value depends on switching frequency, ambient conditions, change in the desired contact resistance, and the absolute value. Please use a relay with AgPd contacts if your needs analog low level loads, control, or a contact resistance of 100 mΩ or less.

We recommend that you verify with one of our sales offices regarding usage.

10. Contact Resistance

This value is the combined resistance of the resistance when the contacts are touching each other, the resistance of the terminals and contact spring. The contact resistance is measured using the

voltage-drop method as shown below. The measuring currents are designated.

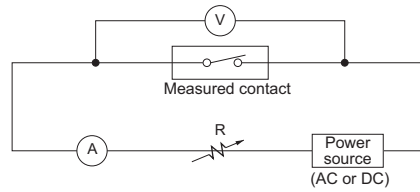

Ⓐ: Ammeter Ⓥ: Voltmeter Ⓡ: Variable resistor

Test Currents

Rated Contact Current or Switching Current (A)	Test Current (mA)
Less than 0.01	1
0.01 or more and less than 0.1	10
0.1 or more and less than 1	100
1 or more	1,000

The resistance can be measured with reasonable accuracy on a YHP 4328A milliohmmer.

In general, for relays with a contact rating of 1A or more, measure using the voltage-drop method at 1A 6V DC.

11. Maximum Carrying Current

The maximum current which after closing or prior to opening, the contacts can safely pass without being subject to temperature rise in excess of their design limit, or the design limit of other temperature sensitive components in the relay (coil, springs, insulation, etc.). This value is usually in excess of the maximum switching current.

12. Capacitance

This value is measured between the terminals at 1kHz and 20°C 68°F.

ELECTRICAL PERFORMANCE

1. Insulation Resistance

The resistance value between all mutually isolated conducting sections of the relay, i.e. between coil and contacts, across open contacts and between coil or contacts to any core or frame at ground potential. This value is usually expressed as "initial insulation resistance" and may decrease with time, due to material degradation and the accumulation of contaminants.

- Between coil and contacts
- Between open contacts
- Between contact sets
- Between set coil and reset coil

2. Breakdown Voltage

(Hi-Pot or Dielectric Strength)

The maximum voltage which can be tolerated by the relay without damage for a specified period of time, usually measured at the same points as insulation resistance. Usually the stated value is in VAC (RMS) for one minute duration.

3. Surge Breakdown Voltage

The ability of the device to withstand an abnormal externally produced power surge, as in a lightning strike, or other phenomenon. An impulse test waveform

is usually specified, indicating rise time, peak value and fall time.

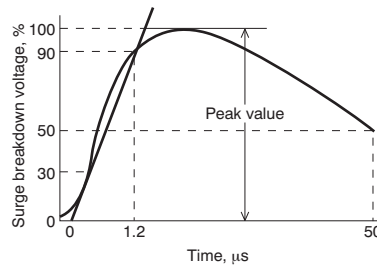

4. Operate Time (Set Time)

The elapsed time from the initial application of power to the coil, until the closure of the Form A (normally open) contacts. (With multiple pole devices the time until the last contact closes.) This time does not include any bounce time.

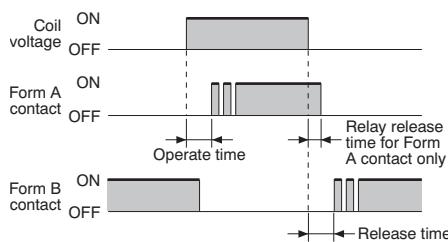

5. Release Time (Reset Time)

The elapsed time from the initial removal of coil power until the reclosure of the Form B (normally closed) contacts (last contact with multi-pole). This time does not include any bounce time.

6. Contact Bounce (Time)

Generally expressed in time (ms), this refers to the intermittent switching phenomenon of the contacts which occurs due to the collision between the movable metal parts or contacts, when the relay is operated or released.

MECHANICAL PERFORMANCE AND LIFE

1. Shock Resistance

1) Functional

The acceleration which can be tolerated by the relay during service without causing the closed contacts to open for more than the specified time. (usually 10 μ s)

2) Destructive

The acceleration which can be withstood by the relay during shipping or installation without it suffering damage, and without causing a change in its operating characteristics. Usually expressed in "G"s. However, test was performed a total of 18 times, six times each in three-axis directions.

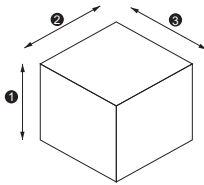

2. Vibration Resistance

1) Functional

The vibration which can be tolerated by the relay during service, without causing the closed contacts to open for more than the specified time.

2) Destructive

The vibration which can be withstood by the relay during shipping, installation or use without it suffering damage, and without causing a change in its operating characteristics. Expressed as an acceleration in G's or displacement, and frequency range. However, test was performed a total of six hours, two hours each in three-axis directions.

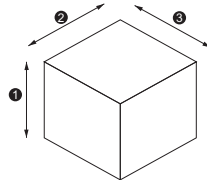

3. Mechanical Life

The minimum number of times the relay can be operated under nominal conditions (coil voltage, temperature, humidity, etc.) with no load on the contacts.

4. Electrical Life

The minimum number of times the relay can be operated under nominal conditions with a specific load being switched by the contacts.

5. Maximum Switching Frequency

This refers to the maximum switching frequency which satisfies the mechanical

life or electrical life under repeated operations by applying a pulse train at the rated voltage to the operating coil.

6. Life Curve

This is listed in the data column for each type of relay. The life (number of operations) can be estimated from the switching voltage and switching current. For example, for a DS relay operating at:

Switching voltage = 125V AC

Switching current = 0.6A

The life expectancy is 300,000 operations. However, this value is for a resistive load. Be sure to carefully check the actual load before use.

Life Curve

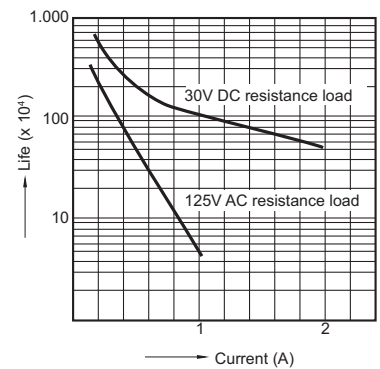

HIGH FREQUENCY CHARACTERISTICS

1. Isolation

High frequency signals leak through the stray capacitance across contacts even if the contacts are separated. This leak is called isolation. The symbol dB (decibel) is used to express the magnitude of the leak signal. This is expressed as the logarithm of the magnitude ratio of the signal generated by the leak with respect to the input signal. The larger the magnitude, the better the isolation.

2. Insertion Loss

At the high frequency region, signal disturbance occurs from self-induction, resistance, and dielectric loss as well as from reflection due to impedance mismatching in circuits. Loss due to any of these types of disturbances is called insertion loss. Therefore, this refers to the magnitude of loss of the input signal. The smaller the magnitude, the better the relay.

3. V.S.W.R.

(Voltage Standing Wave Ratio)

High frequency resonance is generated from the interference between the input signal and reflected (wave) signal.

V.S.W.R. refers to the ratio of the maximum value to minimum value of the waveform. The V.S.W.R. is 1 when there is no reflected wave. It usually becomes greater than 1.

Notes:

1. Except where otherwise specified, the tests above are conducted under standard temperature and humidity (15°C to 35°C 59°F to 95°F, 25 to 75%).
2. The coil impressed voltage in the switching tests is a rectangular wave at the rated voltage.
3. The phase of the AC load operation is random.

GENERAL APPLICATION GUIDELINES

A relay may encounter a variety of ambient conditions during actual use resulting in unexpected failure.

Therefore, testing over a practical range under actual operating conditions is necessary. Application considerations

should be reviewed and determined for proper use of the relay.

SAFETY PRECAUTIONS

- Use that exceeds the specification ranges such as the coil rating, contact rating and switching life should be absolutely avoided. Doing so may lead to abnormal heating, smoke, and fire.
- Never touch live parts when power is applied to the relay. Doing so may cause electrical shock. When installing,

maintaining, or troubleshooting a relay (including connecting parts such as terminals and sockets) be sure that the power is turned off.

- When connecting terminals, please follow the internal connection diagrams in the catalog to ensure that connections are done correctly. Be

warned that an incorrect connection may lead to unexpected operation error, abnormal heating, and fire.

- If the possibility exists that faulty adhesion or contact could endanger assets or human life, take double safety precautions and make sure that operation is foolproof.

[1] METHOD OF DETERMINING SPECIFICATIONS

In order to use the relays properly, the characteristics of the selected relay should be well known, and the conditions of use of the relay should be investigated to determine whether they are matched

to the environmental conditions, and at the same time, the coil conditions, contact conditions, and the ambient conditions for the relay that is actually used must be sufficiently known in

advance. In the table below, a summary has been made of the points of consideration for relay selection. It may be used as a reference for investigation of items and points of caution.

	Specification item	Consideration points regarding selection
Coil	a) Rating b) Pick-up voltage/current c) Drop-out voltage/current d) Maximum continuous voltage/current e) Coil resistance f) Impedance g) Temperature rise	1) Select relay with consideration for power source ripple. 2) Give sufficient consideration to ambient temperature, for the coil temperature rise and hot start. 3) When used in conjunction with semiconductors, additional attention to the application should be taken. Be careful of voltage drops when starting up.
Contacts	a) Contact arrangement b) Contact rating c) Contact material d) Life e) Contact resistance	1) It is desirable to use a standard product with more than the required number of contacts. 2) It is beneficial to have the relay life balanced with the life of the device it is used in. 3) Is the contact material matched to the type of load? It is necessary to take care particularly with low level load. 4) The rated life may become reduced when used at high temperatures. Life should be verified in the actual atmosphere used. 5) Depending on the circuit, the relay drive may synchronize with the AC load. As this will cause a drastic shortening of life should be verified with the actual machine.
Operate time	a) Operate time b) Release time c) Bounce time d) Switching frequency	1) It is beneficial to make the bounce time short for sound circuits and similar applications.
Mechanical characteristics	a) Vibration resistance b) Shock resistance c) Ambient temperature d) Life	1) Give consideration to performance under vibration and shock in the use location. 2) In particular, when used in high temperature applications, relay with class B or class F coil insulation may be required.
Other items	a) Breakdown voltage b) Mounting method c) Size d) Protective construction	1) Selection can be made for connection method with plug-in type, PC board type, soldering, tab terminals, and screw fastening type. 2) For use in an adverse atmosphere, sealed construction type should be selected. 3) When used in adverse environments, use the sealed type. 4) Are there any special conditions?

BASICS ON RELAY HANDLING

- To maintain initial performance, care should be taken to avoid dropping or hitting the relay.
- Under normal use, the relay is designed so that the case will not detach. To maintain initial performance, the case should not be removed. Relay characteristics cannot be guaranteed if the case is removed.
- Use of the relay in an atmosphere at standard temperature and humidity with minimal amounts of dust, SO₂, H₂S, or organic gases is recommended.
For installation in adverse environments, one of the sealed types should be considered.
Please avoid the use of silicone-based resins near the relay, because doing so may result in contact failure. (This applies to plastic sealed type relays, too.)
- Care should be taken to observe correct coil polarity (+, -) for polarized relays.
- Proper usage requires that the rated voltage be impressed on the coil. Use rectangular waves for DC coils and sine waves for AC coils.
- Be sure the coil impressed voltage does not continuously exceed the maximum allowable voltage.
- The rated switching power and life are given only as guides. The physical phenomena at the contacts and contact life greatly vary depending on the type of load and the operating conditions. Therefore, be sure to carefully check the type of load and operating conditions before use.
- Do not exceed the usable ambient temperature values listed in the catalog.
- Use the flux-resistant type or sealed type if automatic soldering is to be used.
- Use alcohol based cleaning solvents when cleaning is to be performed using a sealed type relay. Avoid ultrasonic cleaning of all types of relays.
- As a guide, use a Faston mounting pressure of 40 to 70N {4 to 7kgf} for relays with tab terminals.
- Avoid bending terminals, because it may cause malfunction.
- For proper use, read the main text for details.

[2] PRECAUTIONS REGARDING COIL INPUT

Application of the rated voltage is the most basic requirement for accurate relay operation. Although the relay will work if the voltage applied exceeds the pick-up voltage, it is required that only the rated voltage be applied to the coil out of

consideration for changes in coil resistance, etc., due to differences in power supply type, voltage fluctuations, and rises in temperature. Also, caution is required, because problems such as layer shorts and burnout in the coil may

occur if the voltage applied exceeds the maximum that can be applied continuously. The following section contains precautions regarding coil input. Please refer to it in order to avoid problems.

1. Basic Precautions Regarding Coil

• AC operation type

For the operation of AC relays, the power source is almost always a commercial frequency (50 or 60Hz) with standard voltages of 6, 12, 24, 48, 115, 120, 230 and 240V AC. Because of this, when the voltage is other than the standard voltage, the product is a special order item, and the factors of price, delivery, and stability of characteristics may create inconveniences. To the extent that it is possible, the standard voltages should be selected.

Also, in the AC type, shading coil resistance loss, magnetic circuit eddy current loss, and hysteresis loss exist, and because of lower coil efficiency, it is normal for the temperature rise to be greater than that for the DC type.

Furthermore, because humming occurs when below the pick-up voltage and when above the rated voltage, care is required with regard to power source voltage fluctuations.

For example, in the case of motor starting, if the power source voltage drops, and during the humming of the relay, if it reverts to the restored condition, the contacts suffer a burn

damage and welding, with the occurrence of a false operation self-maintaining condition.

For the AC type, there is an inrush current during the operation time (for the separated condition of the armature, the impedance is low and a current greater than rated current flows; for the adhered condition of the armature, the impedance is high and the rated value of current flows), and because of this, for the case of several relays being used in parallel connection, it is necessary to give consideration to power consumption.

• DC operation type

For the operation of DC relays, standards exist for power source voltage and current, with DC voltage standards set at 5, 6, 12, 24, 48, and 100V, but with regard to current, the values as expressed in catalogs in milliamperes of pick-up current.

However, because this value of pick-up current is nothing more than a guarantee of just barely moving the armature, the variation in energizing voltage and resistance values, and the increase in coil resistance due to temperature rise, must be given consideration for the worst

possible condition of relay operation, making it necessary to consider the current value as 1.5 to 2 times the pick-up current. Also, because of the extensive use of relays as limit devices in place of meters for both voltage and current, and because of the gradual increase or decrease of current impressed on the coil causing possible delay in movement of the contacts, there is the possibility that the designated control capacity may not be satisfied. Thus it is necessary to exercise care. The DC type relay coil resistance varies due to ambient temperature as well as to its own heat generation to the extent of about 0.4%/°C, and accordingly, if the temperature increases, because of the increase in pick-up and drop-out voltages, care is required.

(However, for some polarized relays, this rate of change is considerably smaller.)

General Application Guidelines

2. Power Source for Coil Input

• Energizing voltage of AC coil

In order to have stable operation of the relay, the energizing voltage should be basically within the range of +10%/-15% of the rated voltage. However, it is necessary that the waveform of the voltage impressed on the coil be a sine wave. There is no problem if the power source is commercially provided power, but when a stabilized AC power source is used, there is a waveform distortion due to that equipment, and there is the possibility of abnormal overheating. By means of a shading coil for the AC coil, humming is stopped, but with a distorted waveform, that function is not displayed.

Figure 1 shows an example of waveform distortion.

If the power source for the relay operating circuit is connected to the same line as motors, solenoids, transformers, and other loads, when these loads operate, the line voltage drops, and because of this the relay contacts suffer the effect of vibration and subsequent burn damage. In particular, if a small type transformer is used and its capacity has no margin of safety, when there is long wiring, or in the case of household use or small sales shop use where the wiring is slender, it is necessary to take precautions because of the normal voltage fluctuations combined with these other factors. When trouble develops, a

survey of the voltage situation should be made using a synchroscope or similar means, and the necessary counter-measures should be taken, and together with this determine whether a special relay with suitable excitation characteristics should be used, or make a change in the DC circuit as shown in Figure 2 in which a capacitor is inserted to absorb the voltage fluctuations.

In particular, when a magnetic switch is being used, because the load becomes like that of a motor, depending upon the application, separation of the operating circuit and power circuit should be tried and investigated.

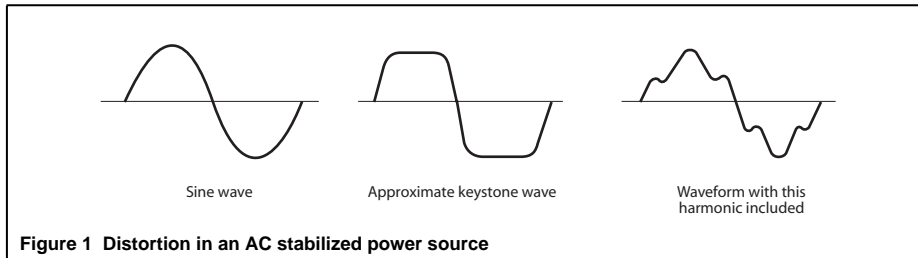

Figure 1 Distortion in an AC stabilized power source

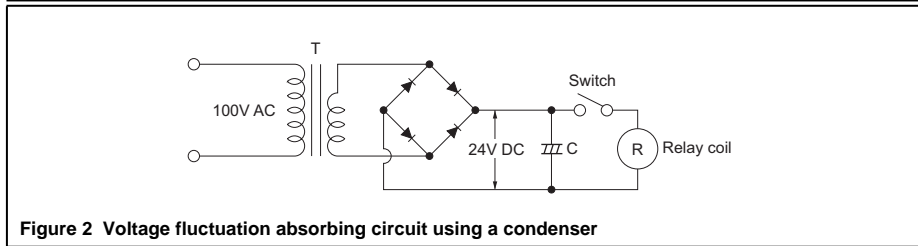

Figure 2 Voltage fluctuation absorbing circuit using a condenser

• Power source for DC input

We recommend that the voltage applied to both ends of the coil in DC type relays be within $\pm 5\%$ of the rated coil voltage.

As a power source for the DC type relay, a battery or either a half wave or full wave rectifier circuit with a smoothing capacitor is used. The characteristics with regard to the pick-up voltage of the relay will change depending upon the type of power source, and because of this, in order to display stable characteristics, the most desirable method is perfect DC.

In the case of ripple included in the DC power source, particularly in the case of half wave rectifier circuit with a smoothing capacitor, if the capacity of the capacitor is too small, due to the influence of the ripple, humming develops and an unsatisfactory condition is produced. With the actual circuit to be used, it is absolutely necessary to confirm the characteristics.

It is necessary to give consideration to the use of a DC power source with less than a 5% ripple. Also ordinarily the following must be given thought.

- It is desirable to have less than a 5% ripple for the reed type relay.
- For the hinge type relay, a half wave rectifier cannot be used, alone unless you use a smoothing capacitor. The ripple and the characteristics must be evaluated for proper usage.
- For the hinge type relay, there are certain applications that may or may not use the full wave rectifier on it's own. Please check specifications with the original manufacture.
- Coil applied voltage and the drop in voltage

Shown following is a circuit driven by the same power supply (battery, etc.) for both the coil and contact. Electrical life will be affected by the drop in voltage in the coil when load is turned on. Please verify that the actual voltage is

applied to the coil at the actual load.

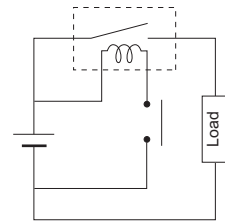

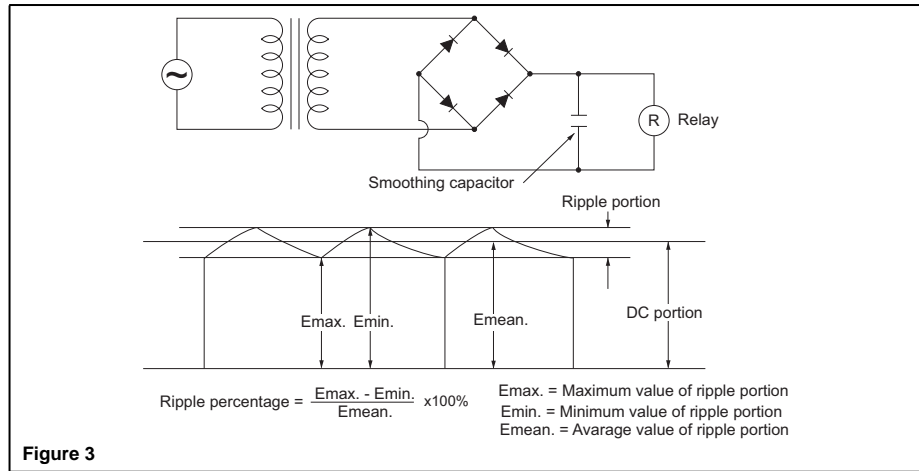

Figure 3

3. Maximum Continuous Voltage and Temperature Rise

Proper usage requires that the rated voltage be impressed on the coil. Note, however, that if a voltage greater than or equal to the maximum continuous voltage is impressed on the coil, the coil may burn or its layers short due to the temperature rise. Furthermore, do not exceed the usable ambient temperature range listed in the catalog.

• Maximum continuous voltage

In addition to being a requirement for relay operation stability, the maximum continuous voltage is an important constraint for the prevention of such problems as thermal deterioration or deformity of the insulation material, or the occurrence of fire hazards.

In actual use with E-type insulation, when the ambient temperature is 40°C 104°F, a temperature rise limit of 80°C 176°F is thought to be reasonable according to the resistance method. However, when complying with the Electrical Appliance

and Material Safety Law, this becomes 75°C 167°F.

• Temperature rise due to pulse voltage

When a pulse voltage with ON time of less than 2 minutes is used, the coil temperature rise bears no relationship to the ON time. This varies with the ratio of ON time to OFF time, and compared with continuous current passage, it is rather small. The various relays are essentially the same in this respect.

Current passage time	%
For continuous passage	Temperature rise value is 100%
ON : OFF = 3 : 1	About 80%
ON : OFF = 1 : 1	About 50%
ON : OFF = 1 : 3	About 35%

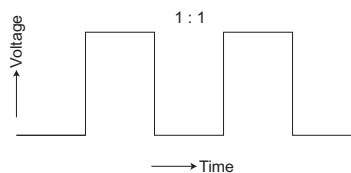

• Pick-up voltage change due to coil temperature rise (hot start)

In DC relays, after continuous passage of current in the coil, if the current is turned OFF, then immediately turned ON again, due to the temperature rise in the coil, the pick-up voltage will become somewhat higher. Also, it will be the same as using it in a higher temperature atmosphere. The resistance/temperature relationship for copper wire is about 0.4% for 1°C, and with this ratio the coil resistance increases. That is, in order to operate of the relay, it is necessary that the voltage be higher than the pick-up voltage and the pick-up voltage rises in accordance with the increase in the resistance value. However, for some polarized relays, this rate of change is considerably smaller.

4. Coil Applied Voltage and Operate Time

In the case of AC operation, there is extensive variation in operate time depending upon the point in the phase at which the switch is turned ON for coil excitation, and it is expressed as a certain range, but for miniature types it is for the most part 1/2 cycle. However, for the somewhat large type relay where

bounce is large, the operate time is 7 to 16ms, with release time in the order of 9 to 18ms. Also, in the case of DC operation, to the extent of large coil input, the operating time is rapid, but if it is too rapid, the "Form A" contact bounce time is extended.

Please be warned that load conditions (in particular when inrush current is large or load is close to the load rating) may cause the working life to shorten and slight welding.

5. Stray Circuits (Bypass Circuits)

In the case of sequence circuit construction, because of bypass flow or alternate routing, it is necessary to take care not to have erroneous operation or abnormal operation. To understand this condition while preparing sequence circuits, as shown in Figure 4, with 2 lines written as the power source lines, the

upper line is always ⊕ and the lower line ⊖ (when the circuit is AC, the same thinking applies). Accordingly the ⊕ side is necessarily the side for making contact connections (contacts for relays, timers and limit switches, etc.), and the ⊖ side is the load circuit side (relay coil, timer coil, magnet coil, solenoid coil,

motor, lamp, etc.).

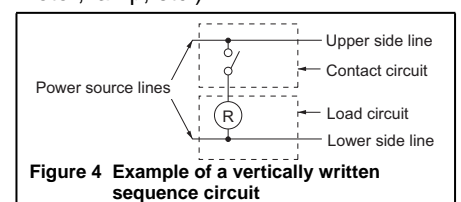

Figure 4 Example of a vertically written sequence circuit

General Application Guidelines

Figure 5 shows an example of stray circuits. In Figure 5 (a), with contacts A, B, and C closed, after relays R₁, R₂, and R₃ operate, if contacts B and C open, there is a series circuit through A, R₁, R₂, and R₃, and the relays will hum and

sometimes not be restored to the drop out condition.

The connections shown in Figure 5 (b) are correctly made. In addition, with regard to the DC circuit, because it is

simple by means of a diode to prevent stray circuits, proper application should be made.

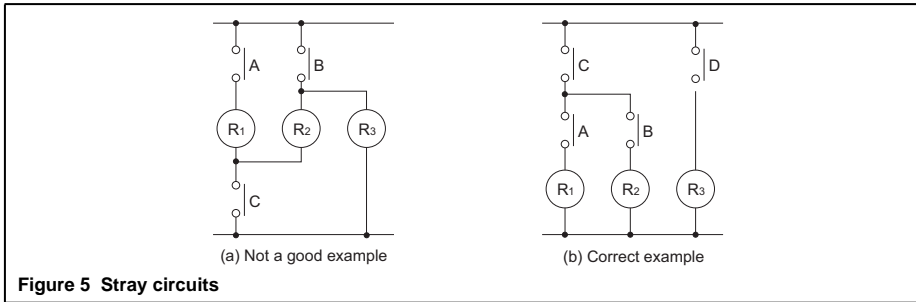

Figure 5 Stray circuits

6. Gradual Increase of Coil Impressed Voltage and Suicide Circuit

When the voltage impressed on the coil is increased slowly, the relay transferring operation is unstable, the contact pressure drops, contact bounce increases, and an unstable condition of contact occurs. This method of applying voltage to the coil should not be used, and consideration should be given to the method of impressing voltage on the coil (use of switching circuit). Also, in the

case of latching relays, using self "Form B" contacts, the method of self coil circuit for complete interruption is used, but because of the possibility of trouble developing, care should be taken.

The circuit shown in Figure 6 causes a timing and sequential operation using a reed type relay, but this is not a good example with mixture of gradual increase of impressed voltage for the coil and a

suicide circuit. In the timing portion for relay R₁, when the timing times out, chattering occurs causing trouble. In the initial test (trial production), it shows favorable operation, but as the number of operations increases, contact blackening (carbonization) plus the chattering of the relay creates instability in performance.

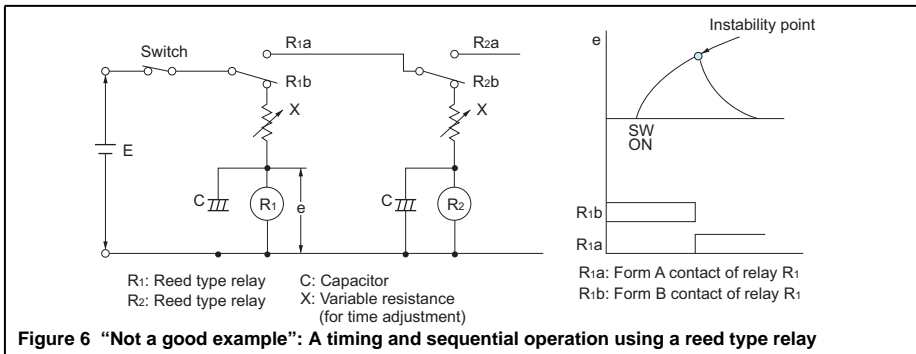

Figure 6 "Not a good example": A timing and sequential operation using a reed type relay

7. Phase Synchronization in AC Load Switching

If switching of the relay contacts is synchronized with the phase of the AC power, reduced electrical life, welded contacts, or a locking phenomenon (incomplete release) due to contact

material transfer may occur. Therefore, check the relay while it is operating in the actual system. When driving relays with timers, micro computers and thyristors,

etc., there may be synchronization with the power supply phase.

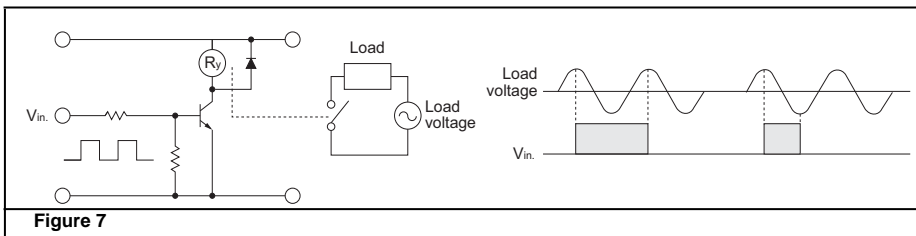

Figure 7

8. Erroneous Operation due to Inductive Interference

For long wire runs, when the line for the control circuit and the line for electric power use a single conduit, induction voltage, caused by induction from the power line, will be applied to the operation coil regardless of whether or not the control signal is off. In this case the relay and timer may not revert.

Therefore, when wiring spans a long distance please remember that along with inductive interference, connection failure may be caused by a problem with distribution capacity or the device might break down due to the influence of externally caused surges, such as that caused by lightning.

9. Long Term Current Carrying

A circuit designed for non-excitation when left running is desirable for circuits (circuits for emergency lamps, alarm devices and error inspection that, for example, revert only during malfunction and output warnings with form B contacts) that will be carrying a current

continuously for long periods without relay switching operation.

Continuous, long-term current to the coil will facilitate deterioration of coil insulation and characteristics due to heating of the coil itself.

For circuits such as these, please use a magnetic-hold type latching relay. If you must use a single stable relay, use a sealed type relay that is not easily affected by ambient conditions and provide a failsafe circuit design that considers the possibility of contact failure or disconnection.

10. Usage with Infrequent Switching

Please carry out periodic contact conductivity inspections when the frequency of switching is once or fewer times per month. When no switching of

the contacts occurs for long periods, organic membrane may form on the contact surfaces and lead to contact instability.

11. Regarding Electrolytic Corrosion of Coils

In the case of comparatively high voltage coil circuits, when such relays are used in high temperature and high humidity atmospheres or with continuous passage of current, the corrosion can be said to be the result of the occurrence of electrolytic corrosion. Because of the possibility of open circuits occurring, attention should be given to the following points.

- The ⊕ side of the power source should be connected to the chassis. (Refer to Figure 8) (Common to all relays)

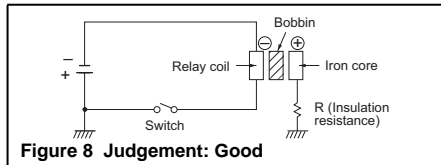

Figure 8 Judgement: Good

- In the case where unavoidably the ⊕ side is grounded, or in the case where grounding is not possible.

- Insert the contacts (or switch) in the ⊕ side of the power source. (Refer to Figure 9) (Common to all relays)

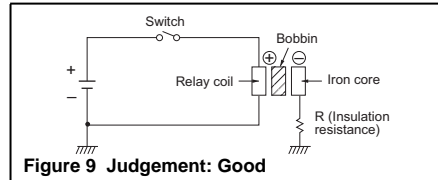

Figure 9 Judgement: Good

- When a grounding is not required, connect the ground terminal to the ⊕ side of the coil. (Refer to Figure 10) (NF and NR with ground terminal)

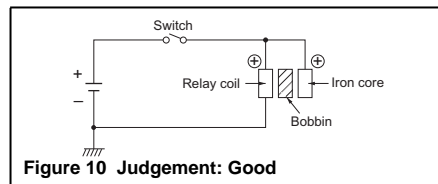

Figure 10 Judgement: Good

- When the ⊕ side of the power source is grounded, always avoid interting the contacts (and switches) in the ⊕ side.

(Refer to Figure 11) (Common to all relays)

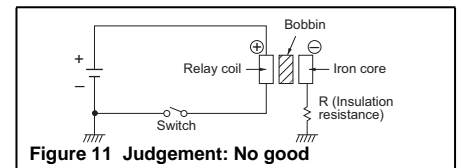

Figure 11 Judgement: No good

- In the case of relays provided with a ground terminal, when the ground terminal is not considered effective, not making a connection to ground plays an important role as a method for preventing electrolytic corrosion.

Note: The designation on the drawing indicates the insertion of insulation between the iron core and the chassis. In relays where a ground terminal is provided, the iron core can be grounded directly to the chassis, but in consideration of electrolytic corrosion, it is more expedient not to make the connection.

[3] PRECAUTIONS REGARDING CONTACT

• Contact

The contacts are the most important elements of relay construction. Contact performance conspicuously influenced by contact material, and voltage and current values applied to the contacts (in particular, the voltage and current

waveforms at the time of application and release), the type of load, frequency of switching, ambient atmosphere, form of contact, contact switching speed, and of bounce.

Because of contact transfer, welding, abnormal wear, increase in contact

resistance, and the various other damages which bring about unsuitable operation, the following items require full investigation.

*We recommend that you verify with one of our sales offices

1. Basic Precautions Regarding Contact

• Voltage, AC and DC

When there is inductance included in the circuit, a rather high counter emf is generated as a contact circuit voltage, and since, to the extent of the value of that voltage, the energy applied to the contacts causes damage with consequent wear of the contacts, and transfer of the contacts, it is necessary to

exercise care with regard to control capacity. In the case of DC, there is no zero current point such as there is with AC, and accordingly, once a cathode arc has been generated, because it is difficult to quench that arc, the extended time of the arc is a major cause. In addition, due to the direction of the current being fixed, the phenomenon of contact shift, as noted separately below, occurs in relation

to the contact wear. Ordinarily, the approximate control capacity is mentioned in catalogs or similar data sheets, but this alone is not sufficient. With special contact circuits, for the individual case, the maker either estimates from the past experience or makes test on each occasion. Also, in catalogs and similar data sheets, the control capacity that is mentioned is

General Application Guidelines

limited to resistive load, but there is a broad meaning indicated for that class of relay, and ordinarily it is proper to think of current capacity as that for 125V AC circuits.

Minimum applicable loads are given in the catalog; however, these are only provided as a guide to the lower limit that the relay is able to switch and are not guaranteed values. The level of reliability of these values depends on switching

frequency, ambient conditions, change in the desired contact resistance, and the absolute value. Please use relays with AgPd contacts when minute analog load control or contact resistance no higher than 100 mΩ is desired (for measurement and wireless applications, etc.).

• Current

The current at both the closing and opening time of the contact circuit exerts

important influence. For example, when the load is either a motor or a lamp, to the extent of the inrush current at the time of closing the circuit, wear of the contacts, and the amount of contact transfer increase, and contact welding and contact transfer make contact separation impossible.

2. Characteristics of Common Contact Materials

Characteristics of contact materials are given below. Refer to them when selecting a relay.

Contact Material	Ag (silver)	Electrical conductivity and thermal conductivity are the highest of all metals. Exhibits low contact resistance, is inexpensive and widely used. A disadvantage is it easily develops a sulfide film in a sulfide atmosphere. Care is required at low voltage and low current levels.
	AgSnO ₂ (silver-tin)	Exhibits superior welding resistance characteristics equal or better than AgCdO. Like silver, it easily develops a sulfide film in a sulfide atmosphere.
	AgW (silver-tungsten)	Hardness and melting point are high, arc resistance is excellent, and it is highly resistant to material transfer. However, high contact pressure is required. Furthermore, contact resistance is relatively high and resistance to corrosion is poor. Also, there are constraints on processing and mounting to contact springs.
	AgNi (silver-nickel)	Equals the electrical conductivity of silver. Excellent arc resistance.
	AgPd (silver-palladium)	At standard temperature, good corrosion resistance and good sulfidation resistance. However, in dry circuits, organic gases adhere and it easily develops a polymer. Gold clad is used to prevent polymer buildup. Expensive.
Surface Finish	Rh plating (rhodium)	Combines perfect corrosion resistance and hardness. As plated contacts, used for relatively light loads. In an organic gas atmosphere, care is required as polymers may develop. Therefore, it is used in hermetic sealed relays (reed relays, etc.). Expensive.
	Au clad (gold clad)	Au with its excellent corrosion resistance is pressure welded onto a base metal. Special characteristics are uniform thickness and the nonexistence of pinholes. Greatly effective especially for low level loads under relatively adverse atmospheres. Often difficult to implement clad contacts in existing relays due to design and installation.
	Au plating (gold plating)	Similar effect to Au clad. Depending on the plating process used, supervision is important as there is the possibility of pinholes and cracks. Relatively easy to implement gold plating in existing relays.
	Au flash plating (gold thin-film plating) 0.1 to 0.5μm	Purpose is to protect the contact base metal during storage of the switch or device with built-in switch. However, a certain degree of contact stability can be obtained even when switching loads.

3. Contact Protection

• Counter EMF

When switching inductive loads with a DC relay such as relay sequence circuits, DC motors, DC clutches, and DC solenoids, it is always important to absorb surges (e.g. with a diode) to protect the contacts.

When these inductive loads are switched off, a counter emf of several hundred to several thousand volts develops which can severely damage contacts and greatly shorten life. If the current in these loads is relatively small at around 1A or less, the counter emf will cause the ignition of a glow or arc discharge. The discharge decomposes organic matter

contained in the air and causes black deposits (oxides, carbides) to develop on the contacts. This may result in contact failure.

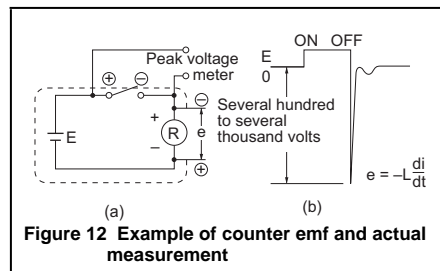

Figure 12 (a), a counter emf ($e = -L di/dt$) with a steep waveform is generated across the coil with the polarity shown in

Figure 12 (b) at the instant the inductive load is switched off. The counter emf passes through the power supply line and reaches both contacts.

Generally, the critical dielectric breakdown voltage at standard temperature and pressure in air is about 200 to 300 volts. Therefore, if the counter emf exceeds this, discharge occurs at the contacts to dissipate the energy ($1/2 Li^2$) stored in the coil. For this reason, it is desirable to absorb the counter emf so that it is 200V or less.

• Material transfer phenomenon

Material transfer of contacts occurs when one contact melts or boils and the contact material transfers to the other contact. As the number of switching operations increases, uneven contact surfaces develop such as those shown in Figure 13. After a while, the uneven contacts

lock as if they were welded together. This often occurs in circuits where sparks are produced at the moment the contacts "make" such as when the DC current is large for DC inductive or capacitive loads or when the inrush current is large (several amperes or several tens of amperes).

Contact protection circuits and contact materials resistant to material transfer such as AgSnO₂, AgW or AgCu are used as countermeasures. Generally, a concave formation appears on the cathode and a convex formation appears on the anode. For DC capacitive loads (several amperes to several tens of

amperes), it is always necessary to conduct actual confirmation tests.

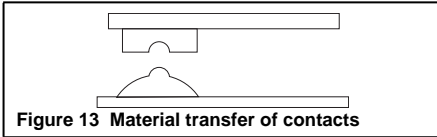

Figure 13 Material transfer of contacts

• **Contact protection circuit**

Use of contact protective devices or protection circuits can suppress the counter emf to a low level. However, note

that incorrect use will result in an adverse effect. Typical contact protection circuits are given in the table below.

(G: Good, NG: No Good, C: Conditional)

Circuit	Application		Features/Others	Devices Selection	
	AC	DC			
CR circuit		C*	G	If the load is a timer, leakage current flows through the CR circuit causing faulty operation. * If used with AC voltage, be sure the impedance of the load is sufficiently smaller than that of the CR circuit	As a guide in selecting c and r, c: 0.5 to 1μF per 1A contact current r: 0.5 to 1Ω per 1V contact voltage Values vary depending on the properties of the load and variations in relay characteristics. Capacitor "c" acts to suppress the discharge the moment the contacts open. Resistor "r" acts to limit the current when the power is turned on the next time. Test to confirm. Use a capacitor "c" with a breakdown voltage of 200 to 300V. Use AC type capacitors (non-polarized) for AC circuits.
		G	G	If the load is a relay or solenoid, the release time lengthens. Effective when connected to both contacts if the power supply voltage is 24 or 48V and the voltage across the load is 100 to 200V.	
Diode circuit		NG	G	The diode connected in parallel causes the energy stored in the coil to flow to the coil in the form of current and dissipates it as joule heat at the resistance component of the inductive load. This circuit further delays the release time compared to the CR circuit. (2 to 5 times the release time listed in the catalog)	Use a diode with a reverse breakdown voltage at least 10 times the circuit voltage and a forward current at least as large as the load current. In electronic circuits where the circuit voltages are not so high, a diode can be used with a reverse breakdown voltage of about 2 to 3 times the power supply voltage.
Diode and zener diode circuit		NG	G	Effective when the release time in the diode circuit is too long.	Use a zener diode with a zener voltage about the same as the power supply voltage.
Varistor circuit		G	G	Using the stable voltage characteristics of the varistor, this circuit prevents excessively high voltages from being applied across the contacts. This circuit also slightly delays the release time. Effective when connected to both contacts if the power supply voltage is 24 to 48V and the voltage across the load is 100 to 200V.	-

- Avoid using the protection circuits shown in the figures on the right. Although DC inductive loads are usually more difficult to switch than resistive loads, use of the proper protection circuit will raise the characteristics to that for resistive loads.

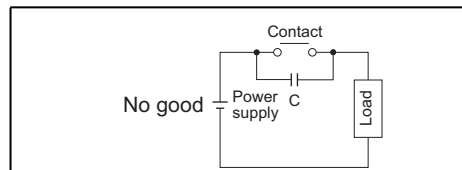

Although extremely effective in arc suppression as the contacts open, the contacts are susceptible to welding since energy is stored in "C" when the contacts open and short-circuit current flows from "C" when the contacts close.

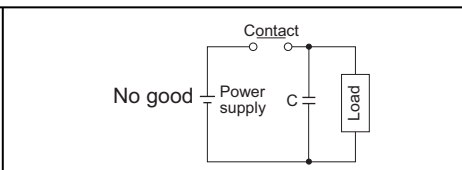

Although extremely effective in arc suppression as the contacts open, the contacts are susceptible to welding since charging current flows to "C" when the contacts close.

• **Mounting the protective device**

In the actual circuit, it is necessary to locate the protective device (diode, resistor, capacitor, varistor, etc.) in the immediate vicinity of the load or contact. If located too far away, the effectiveness of the protective device may diminish. As a guide, the distance should be within 50cm.

• **Abnormal corrosion during high frequency switching of DC loads (spark generation)**

If, for example, a DC valve or clutch is switched at a high frequency, a blue-green corrosion may develop. This occurs from the reaction with nitrogen and oxygen in the air when sparks (arc discharge) are generated during

switching. Therefore, care is required in circuits where sparks are generated at a high frequency.

General Application Guidelines

4. Cautions on Use Related to Contacts

• Connection of load and contacts

Connect the load to one side of the power supply as shown in Figure 14 (a).
Connect the contacts to the other side.

This prevents high voltages from developing between contacts. If contacts are connected to both side of the power supply as shown in Figure 14 (b), there is

a risk of shorting the power supply when relatively close contacts short.

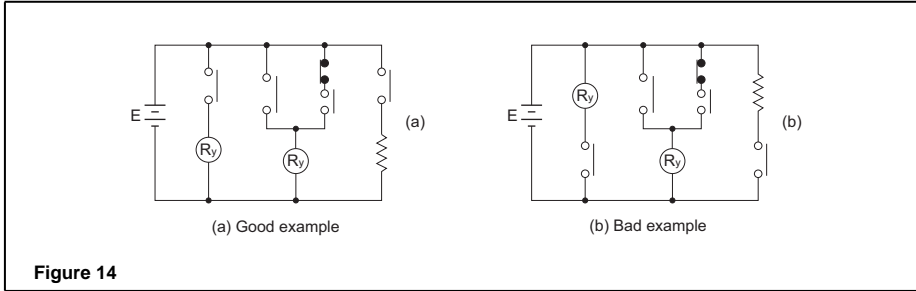

Figure 14

• Dummy Resistor

Since voltage levels at the contacts used in low current circuits (dry circuits) are

low, poor conduction is often the result. One method to increase reliability is to add a dummy resistor in parallel with the

load to intentionally raise the load current reaching the contacts.

• Avoid circuits where shorts occur between Form A and B contacts

1) The clearance between form A and B contacts in compact control components is small. The occurrence of shorts due to arcing must be assumed.

2) Even if the three N.C., N.O., and COM contacts are connected so that they short, a circuit must never be designed to allow the possibility of burning or generating an overcurrent.

3) A forward and reverse motor rotation circuit using switching of form A and B contacts must never be designed.

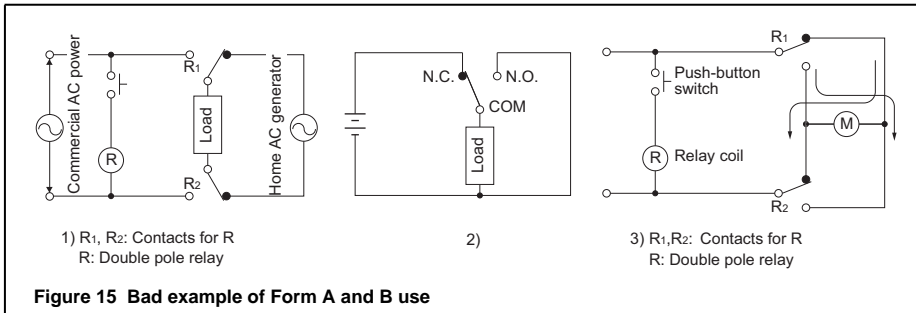

Figure 15 Bad example of Form A and B use

• Shorts between different electrodes

Although there is a tendency to select miniature control components because of the trend toward miniaturizing electrical control units, care must be taken when selecting the type of relay in circuits where different voltages are applied between electrodes in a multi-pole relay, especially when switching two different power supply circuits. This is not a problem that can be determined from sequence circuit diagrams. The construction of the control component itself must be examined and sufficient margin of safety must be provided especially in creepage between electrodes, space distance, presence of barrier, etc.

• Type of load and inrush current

The type of load and its inrush current characteristics, together with the switching frequency, are important factors which cause contact welding.

Particularly for loads with inrush currents, measure the steady state and inrush current. Then select a relay which provides an ample margin of safety. The table on the right shows the relationship

between typical loads and their inrush currents.

Also, verify the actual polarity used since, depending on the relay, electrical life is affected by the polarity of COM and NO.

Type of load	Inrush current
Resistive load	Steady state current
Solenoid load	10 to 20 times the steady state current
Motor load	5 to 10 times the steady state current
Incandescent lamp load	10 to 15 times the steady state current
Mercury lamp load	Approx. 3 times the steady state current
Sodium vapor lamp load	1 to 3 times the steady state current
Capacitive load	20 to 40 times the steady state current
Transformer load	5 to 15 times the steady state current

Load Inrush Current Wave and Time

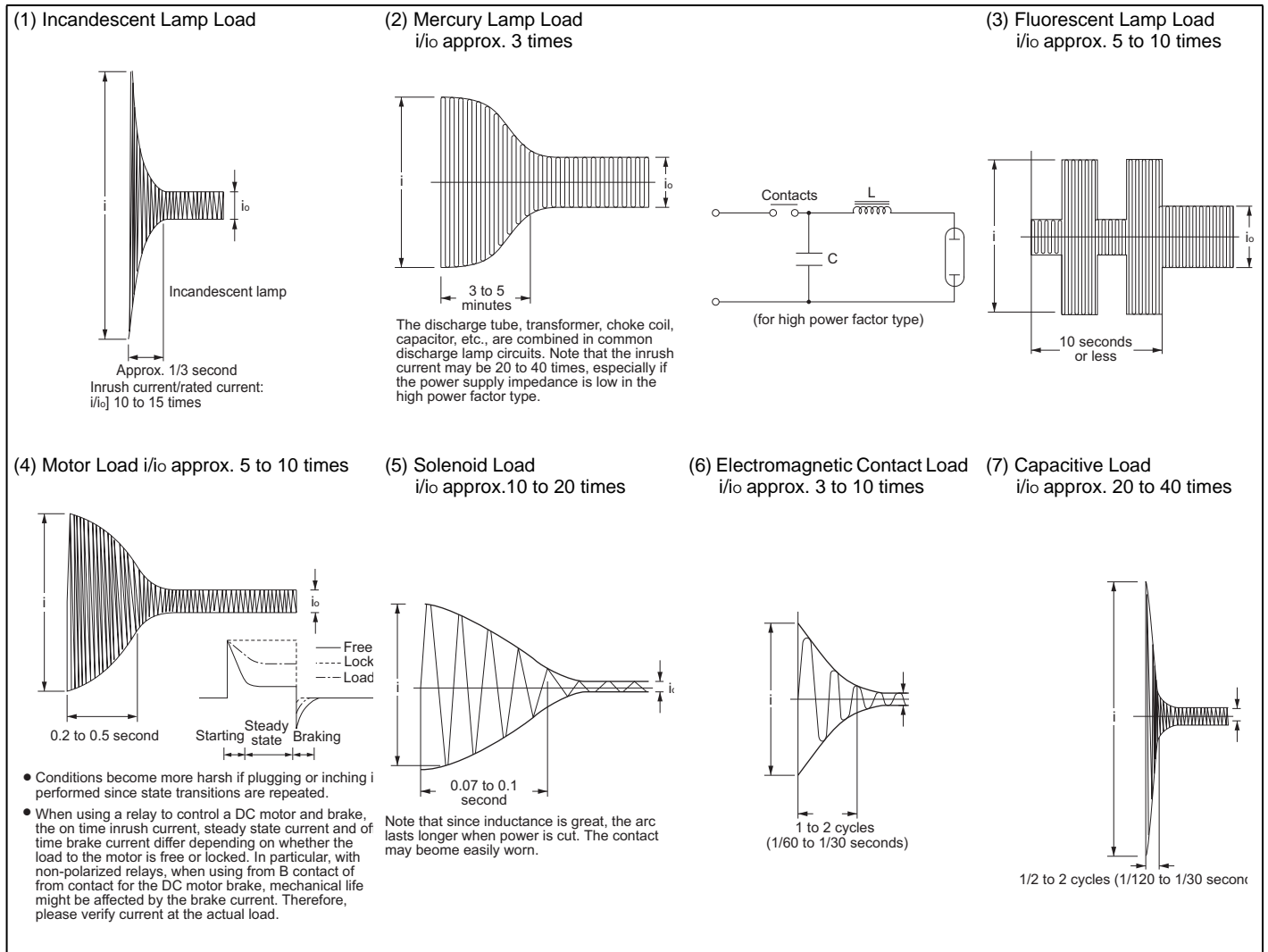

• When using long wires

If long wires (100 to 300m) are to be used in a relay contact circuit, inrush current may become a problem due to the stray capacitance existing between wires. Add a resistor (approx. 10 to 50Ω) in series with the contacts.

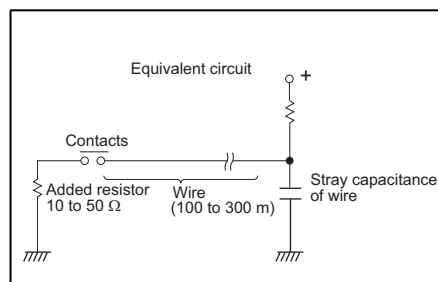

• Electrical life at high temperatures

Verify at the actual load since electrical life may be affected by use at high temperatures.

General Application Guidelines

[4] PRECAUTIONS REGARDING LATCHING RELAYS

- Latching relays are shipped from the factory in the reset state. A shock to the relay during shipping or installation may cause it to change to the set state. Therefore, it is recommended that the relay be used in a circuit which initializes the relay to the required state (set or reset) whenever the power is turned on.

- Avoid impressing voltages to the set coil and reset coil at the same time.

- Connect a diode as shown since latching may be compromised when the relay is used in the following circuits.

- If set coils or reset coils are to be connected together in parallel, connect a diode in series to each coil. Figure 16 (a), (b)
- Also, if the set coil of a relay and the reset coil of another relay are connected in parallel, connect a diode to the coils in series. Figure 16 (c)

- If the set coil or reset coil is to be connected in parallel with an inductive load (e.g. another electromagnetic relay coil, motor, transformer, etc.), connect a diode to the set coil or reset coil in series. Figure 16 (d)

- Use a diode having an ample margin of safety for repeated DC reverse voltage and peak reverse voltage applications and having an average rectified current greater than or equal to the coil current.

- Avoid applications in which conditions include frequent surges to the power supply.

- Avoid using the following circuit since self-excitation at the contacts will inhibit the normal keep state

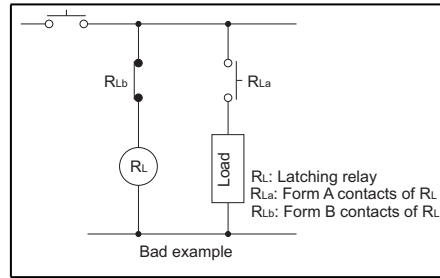

- Four-terminal latching relay

In the 2-coil latching type circuit as shown below, one terminal at one end of the set coil and one terminal at one end of the reset coil are connected in common and voltages of the same polarity are applied to the other side for the set and reset operations. In this type of circuit, short 2 terminals of the relay as noted in the table. This helps to keep the insulation high between the two winding.

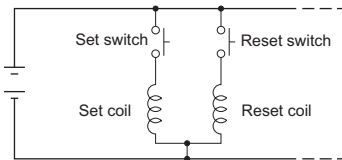

- Minimum pulse width

As a guide, make the minimum pulse width in order to set or reset a latching relay at least 5 times the set time or reset time of each product and apply a rectangular-wave rated voltage. Also, please verify operation. Please inquire if you cannot obtain a pulse width of at least 5 times the set (reset) time. Also, please inquire regarding capacitor drive.

Relay Type		Terminal Nos.
DS	1c	—
	2c	15 & 16
	4c	*
NC	Flat	5 & 6
	Slim	3 & 4
ST		*
SP		2 & 4

Notes:

- DS4c and ST relays are constructed so that the set coil and reset coil are separated for high insulation resistance.
- DSP, TQ, S relays are not applicable due to polarity.

- Two Coil Latch Induction Voltage

Each coil in a 2-coil latch relay is wound with a set coil and a reset coil on the same iron cores. Accordingly, induction voltage is generated on the reverse side coil when voltage is applied and shut off to each coil. Although the amount of induction voltage is about the same as the rated relay voltage, you must be careful of the reverse bias voltage when driving transistors.

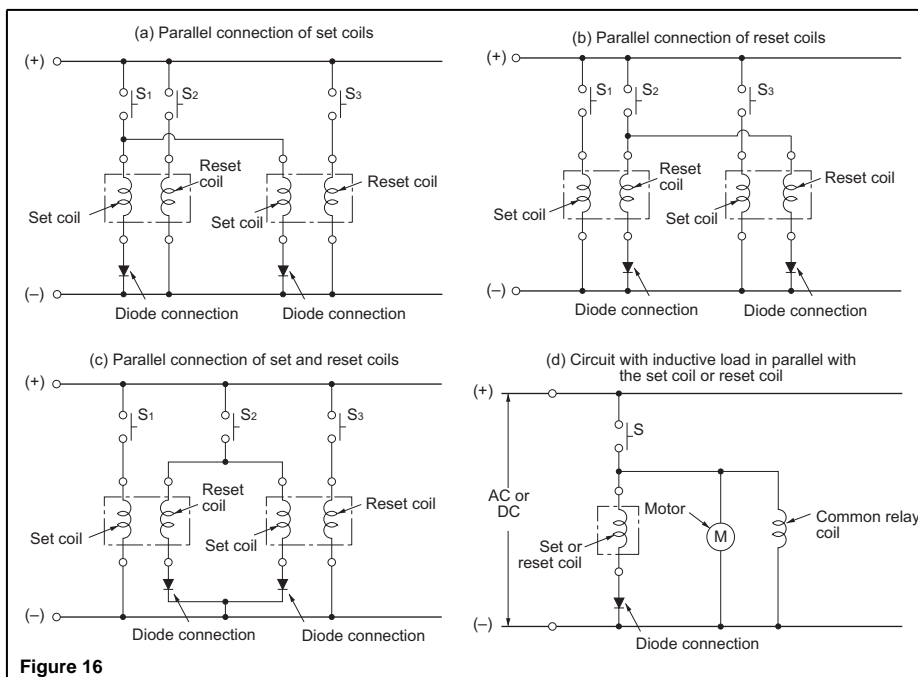

[5] HANDLING CAUTIONS FOR TUBE PACKAGING

Some types of relays are supplied in tube packaging. If you remove any relays from the tube packaging, be sure to slide the stop plug at one end to hold the remaining relays firmly together so they would not move in the tube. Failing to do this may lead to the appearance and/or performance being damaged.

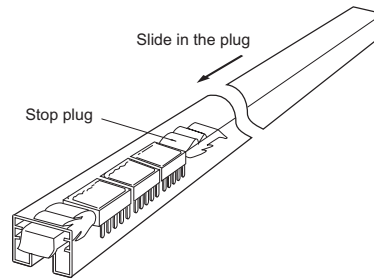

[6] AMBIENT ENVIRONMENT

1. Ambient Temperature and Atmosphere

Be sure the ambient temperature at the installation does not exceed the value listed in the catalog. Furthermore, environmentally sealed types (plastic sealed type) should be considered for applications in an atmosphere with dust, sulfur gases (SO₂, H₂S), or organic gases.

2. Silicone Atmosphere

Silicone-based substances (silicone rubber, silicone oil, silicone-based coating material, silicone caulking compound, etc.) emit volatile silicone gas. Note that when silicone is used near relay, switching the contacts in the presence of its gas causes silicone to adhere to the contacts and may result in contact failure (in plastic sealed types, too).

In this case, use a substitute that is not silicone-based.

3. NOx Generation

When a relay is used in an atmosphere high in humidity to switch a load which easily produces an arc, the NOx created by the arc and the water absorbed from outside the relay combine to produce nitric acid. This corrodes the internal metal parts and adversely affects operation.

Avoid use at an ambient humidity of 85%RH or higher (at 20°C 68°F). If use at high humidity is unavoidable, consult us.

4. Vibration and Shock

If a relay and magnetic switch are mounted next to each other on a single plate, the relay contacts may separate momentarily from the shock produced when the magnetic switch is operated and result in faulty operation. Countermeasures include mounting them on separate plates, using a rubber sheet to absorb the shock, and changing the

direction of the shock to a perpendicular angle.

Also, if the relay will be subject to continual vibration (trains, etc.), do not use it with a socket. We recommend that you solder directly to the relay terminals.

5. Influence of External Magnetic Fields

Permanent magnets are used in reed relays and polarized relays, and their movable parts are constructed of ferrous materials. For this reason, when a magnet or permanent magnet in any other large relay, transformer, or speaker is located nearby, the relay characteristics may change and faulty operations may result. The influence depends on the strength of the magnetic field and it should be checked at the installation.

6. Usage, Storage, and Transport Conditions

During usage, storage, or transportation, avoid locations subject to direct sunlight and maintain normal temperature, humidity, and pressure conditions.

The allowable specifications for environments suitable for usage, storage, and transportation are given below.

• Temperature

The allowable temperature range differs for each relay, so refer to the relay's individual specifications.

In addition, when transporting or storing relays while they are tube packaged, there are cases when the temperature may differ from the allowable range.

In this situation, be sure to consult the individual specifications.

• Humidity

5 to 85 % R.H.

• Pressure

86 to 106 kPa

The humidity range varies with the temperature. Use within the range indicated in the graph.

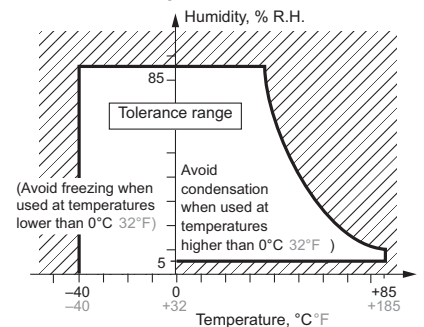

(The allowable temperature depends on the switch.)

- Condensation will occur inside the switch if there is a sudden change in ambient temperature when used in an atmosphere of high temperature and high humidity. This is particularly likely to happen when being transported by ship, so please be careful of the atmosphere when shipping. Condensation is the phenomenon whereby steam condenses to cause water droplets that adhere to the switch when an atmosphere of high temperature and humidity rapidly changes from a high to low temperature or when the switch is quickly moved from a low humidity location to one of high temperature and humidity. Please be careful because condensation can cause adverse conditions such as deterioration of insulation, coil cutoff, and rust.
- Condensation or other moisture may freeze on the switch when the temperatures is lower than 0°C 32°F. This causes problems such as sticking of movable parts or operational time lags.
- The plastic becomes brittle if the switch is exposed to a low temperature, low humidity environment for long periods of time.

General Application Guidelines

- Storage for extended periods of time (including transportation periods) at high temperatures or high humidity levels or in atmospheres with organic gases or sulfide gases may cause a sulfide film or oxide film to form on the surfaces of the contacts and/or it may interfere with the functions. Check out the atmosphere in which the units are to be stored and transported.
- In terms of the packing format used, make every effort to keep the effects of moisture, organic gases and sulfide gases to the absolute minimum.
- Since the SMD type is sensitive to humidity it is packaged with tightly sealed anti-humidity packaging. However, when storing, please be careful of the following:
 - Please use promptly once the anti-humidity pack is opened (Signal relay: with in 3 days, Max. 30°C 86°F/60%RH). If left with the pack open, the relay will absorb moisture which will cause thermal stress when reflow mounting and thus cause the case to expand. As a result, the seal may break.
 - When storing for a long period after opening the anti-humidity pack, you must take measures to prevent humidity, for example, by storing in the open location of a promptly resealed anti-humidity pack after it is used or in a humidity-controlled desiccator. You may also store it in an anti-humidity bag to which silica gel has been added.
 - To avoid incorrect handling of our moisture-sensitive products,

Panasonic affixes a cautionary label to the vacuum-sealed bag in which the products are delivered.

- **Note:**
Please note that the products must be mounted within the time limit specified on the bag. The time limit given on the bag varies for the different kinds of surface-mount terminal type products.

7. Vibration, Impact and Pressure when Shipping

When shipping, if strong vibration, impact or heavy weight is applied to a device in which a relay is installed, functional damage may occur. Therefore, please package in a way, using shock absorbing material, etc., so that the allowable range for vibration and impact is not exceeded.

[7] ENVIRONMENTALLY SEALED TYPE RELAYS

Sealed type (plastic sealed type, etc.) relays are available. They are effective when problems arise during PC board mounting (e.g. automatic soldering and cleaning). They also, of course, feature excellent corrosion resistance. Note the cautions below regarding the features and use of environmentally sealed type relays to avoid problems when using them in applications.

1. Operating Environment

Plastic sealed type relays are not suited for use in environments that especially require air tightness. Although there is no problem if they are used at sea level, avoid atmospheric pressures beyond 96 ± 10 kPa. Also avoid using them in an atmosphere containing flammable or explosive gases.

2. Cleaning

When cleaning a printed circuit board after soldering, we recommend using alcohol based cleaning fluids. Please avoid ultrasonic cleaning. The ultrasonic energy from this type of cleaning may cause coil line breakage and light sticking of contacts.

[8] MOUNTING CONSIDERATIONS

1. Top View and Bottom View

Relays used for PC boards, especially the flat type relays, have their top or bottom surface indicated in the terminal wiring diagrams.

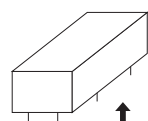

Relay with terminals viewed from the bottom (terminals cannot be seen from the top)

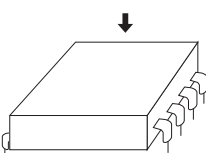

Relay with terminals viewed from the top (all terminals can be seen from the top)
Note during PC board pattern design (NL, NC)

2. Mounting Direction

Mounting direction is important for optimum relay characteristics.

• Shock resistance

It is ideal to mount the relay so that the movement of the contacts and movable parts is perpendicular to the direction of vibration or shock. Especially note that the vibration and shock resistance of

Form B contacts while the coil is not excited is greatly affected by the mounting direction of the relay.

• Contact reliability

Mounting the relay so the surfaces of its contacts (fixed contacts or movable contacts) are vertical prevents dirt and dust as well as scattered contact material (produced due to large loads from which arcs are generated) and powdered metal from adhering to them.

Furthermore, it is not desirable to switch both a large load and a low level load with a single relay. The scattered contact material produced when switching the large load adheres to the contacts when switching the low level load and may cause contact failure. Therefore, avoid mounting the relay with its low level load contacts located below the large load contacts.

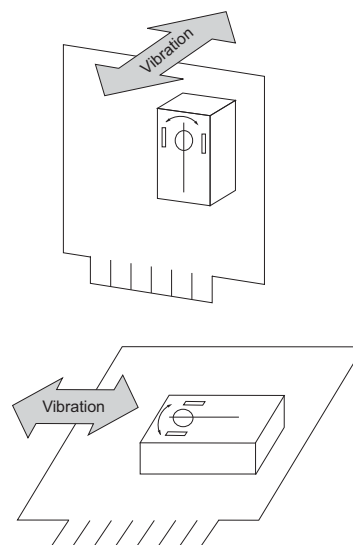

3. Adjacent Mounting

When many relays are mounted close together, abnormally high temperatures may result from the combined heat generated. Mount relays with sufficient spacing between them to prevent heat buildup.

This also applies when a large number of boards mounted with relays are installed as in a card rack. Be sure the ambient

temperature of the relay does not exceed the value listed in the catalog.

• Influence of adjacent mounting of polarized relays

When polarized relays are mounted close together, their characteristics change. Since the affect of adjacent mounting differs according to the type of relay, refer to the data for the particular type.

4. Panel Mounting

- Do not remove the cover. It has a special function. (It will not come off under normal handling.)

[9] METHOD OF MOUNTING AND LEAD WIRES CONNECTION

1. Mounting Method

The direction of mounting is not specifically designated, but to the extent possible, the direction of contact movement should be such that vibration and shock will not be applied.

When a terminal socket is used

After drilling the mounting holes, the terminal socket should be mounted making certain the mounting screws are not loose. DIN standard sockets are available for one-touch mounting on DIN rail of 35mm 1.378 inch width.

When reversible terminal sockets are used

- The reversible terminal sockets (HC, HL socket) are for one-touch mounting. (A panel thickness of 1 to 2mm .039 to .079 inch should be used.)

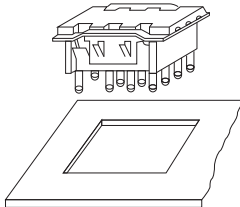

- The socket should be pushed through the opening in the mounting panel until the projections on the side of the mounting bracket extend out over the back surface.

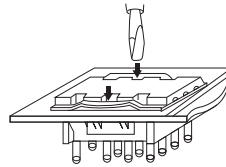

- When all four of the projections are visible from the back side of the mounting panel, the mounting is completed and the socket is fastened.
- To remove the socket, the projections on the side of the mounting bracket should be pushed inward and at the same time the body of the socket should be pushed lightly from the back side. The socket can then be removed from the panel.

2. Connection of Lead Wires

- When making the connections, depending upon the size of load, the wire cross-section should be at least as large as the values shown in the table below.

Permissible current (A)	Cross-section (mm ²)
2	0.2
3	0.3
5	0.5
7.5	0.75
12.5	1.25
15	2
20	2
30	3.5

- When the terminal socket uses screw fastening connections, either pressure terminals or other means should be used to make secure fastening of the wire.
- To prevent damage and deformity, please use a torque within the following range when tightening the push screw block of the terminal socket.

Screw	Torque
M4.5	1.47 to 1.666 N·m (15 to 17 kgf·cm)
M4	1.176 to 1.37 N·m (12 to 14 kgf·cm)
M3.5	0.784 to 0.98 N·m (8 to 10 kgf·cm)
M3	0.49 to 0.69 N·m(5 to 7 kgf·cm)

General Application Guidelines

[10]CAUTIONS FOR USE–CHECK LIST

Item	To check
Coil Drive Input	<ol style="list-style-type: none"> 1) Is the correct rated voltage applied? 2) Is the applied coil voltage within the allowable continuous voltage limit? 3) Is the ripple in the coil voltage within the allowable level? 4) For voltage applied to a polarized coil, is polarity observed? 5) When hot start is required, is the increase in coil resistance resulting from coil temperature rise taken into account in setting coil voltage? 6) Is the coil voltage free from momentary drop caused by load current? (Pay special attention for self-holding relays.) 7) Is supply voltage fluctuation taken into account when setting the rated coil voltage? 8) The relay status may become unstable if the coil voltage (current) is gradually increased or decreased. Was the relay tested in a real circuit or with a real load? 9) When driving with transistors, did you consider voltage drops?
Load (Relay contacts)	<ol style="list-style-type: none"> 1) Is the load rated within the contact ratings? 2) Does the load exceed the contacts' minimum switching capacity? 3) Special attention is required for contact welding when the load is a lamp, motor, solenoid, or electromagnetic contractor. Was the relay tested with a real load? 4) A DC load may cause contact lock-up due to large contact transfer. Was the relay tested with a real load? 5) For an inductive load, is a surge absorber used across the contacts? 6) When an inductive load causes heavy arc discharge across the relay contacts, the contacts may be corroded by chemical reaction with nitrogen in the atmosphere. Was the relay tested with a real load? 7) Platinum contacts may generate brown powder due to a catalyzer effect or vibration energy. Was the relay tested with a real load? 8) Is the contact switching frequency below the specification? 9) When there are more than two sets of contacts (2T) in a relay, metallic powder shed from one set of contacts may cause a contact failure on the other set (particularly for light loads). Was the relay tested in a real load? 10) A delay capacitor used across relay contacts may cause contact welding. Was the relay tested with a real load? 11) For an AC relay, a large contact bounce may cause contact welding. Was the relay tested in a real circuit or with a real load? 12) A high voltage may be induced at transformer load. Was the relay tested with a real load?
Circuit Design	<ol style="list-style-type: none"> 1) Does circuit design take into account electrolytic corrosion of the coil? 2) Are transistors and other circuit components protected from counter electromotive force that develops across the relay coil? 3) Is the circuit designed so the relay coil is left deenergized while the relay is inactive for long period of time? 4) Is the relay operated within the ratings approved by the relevant international standard (if compliance is required)? 5) Is the circuit protected from malfunction when the relay's activation and/or deactivation time varies considerably? 6) Is the circuit protected from malfunctions that might result from relay contact bounce? 7) Is the circuit protected from malfunction when a high-sensitivity latching type relay is to be used? 8) When there are two or more sets of contacts (2T) in a relay, arc discharges from load switching may cause short circuits across the two or more sets of contacts. Is the circuit designed to suppress such arc discharges? 9) Item 8 above also requires special attention when loads are supplied from separate power sources. 10) Does the post-installation insulation distance comply with the requirement of the relevant international standard or the Electrical Appliance and Material Control Law? 11) Is the circuit protected from malfunction when the relay is to be driven by transistors? 12) When the SCR is used for on/off control, the relay activation tends to synchronize with the line frequency, resulting in an extremely shortened life. Was the relay tested in a real circuit or with a real load? 13) Does the PC board design take into account use of on-board relay? 14) RF signals may leak across relay's open contacts. Check for adequate contact isolation and use RF relays as needed

General Application Guidelines

Item	To check
Operating Environment	<ol style="list-style-type: none"> 1) Is the ambient temperature in the allowable operating temperature range? 2) Is the humidity in the allowable humidity range? 3) Is the operating atmosphere free from organic and sulfide gases? 4) Is the operating atmosphere free from silicone gas? Depending on the load type, silicone gas may cause a black substance to form on the contacts, leading to contact failure. 5) Is the operating atmosphere free from excessive airborne dust? 6) Is the relay protected from oil and water splashes? 7) Is the relay protected from vibration and impact which may cause poor contact with the socket? 8) Is ambient vibration and impact below the level allowable for the relay? 9) Is the relay free from mechanical resonance after it is installed in position? 10) Is insulation coating applied to the relay along with the PC board? Depending on the load type, a black substance may form to cause contact failure.
Installation and Connection	<ol style="list-style-type: none"> 1) Is the relay protected from solder chips and flux when it is manually soldered? 2) Are preparations for flux application and automatic soldering complete? 3) Is the PC board cleaning process designed to minimize adverse affects to the relays? 4) Are adequate separations provided between polarized or reed relays to prevent magnetic coupling? 5) Are the relay terminals free from stress in the socket? 6) Polarized relay's characteristics may be affected by strong external magnetic field. Are the relays installed away from such fields? 7) If very long leads (100 to 300 meters) are used to connect the load, the stray capacity existing across the leads may cause the inrush current. Was the relay tested with a real load? 8) Unless otherwise specified, all relay terminals should be soldered at 250°C 482°F within 5 sec. or at 350°C 662°F within 3 sec. 9) A badly warped PC board can cause stress to the relay terminals which may lead to degraded relay characteristics. 10) Glass shot should not be used to clean the PC board of solder flux. This may cause relay malfunction due to glass powder becoming lodged in the relay's internal structure. 11) Relays should always be used with their plastic shields installed, or degraded relay performance may result. 12) Do not cut away any relay terminal as the stress may cause degraded relay performance.
Storage and Transport	<ol style="list-style-type: none"> 1) Is the relay subject to freezing or condensation (especially when shipping)? 2) Is the temperature in the allowable temperature range? 3) Is the humidity in the allowable humidity range? 4) Is the storing atmosphere free from organic and sulfide gases? 5) Is the storing atmosphere free from excessive airborne dust? 6) Is the relay protected from oil and water splashes? 7) Is the relay subject to the application of heavy weight? 8) When shipping does vibration and impact exceed the allowable range?

RELIABILITY

[1] WHAT IS RELIABILITY?

1. Reliability in a Narrow Sense of the Term

In the industrial world, reliability is an index of how long a particular product serves without failure.

2. Reliability in a Broad Sense of the Term

Every product has a finite service lifetime. This means that no product can continue normal service infinitely. When a product has broken down, the user may throw it

away or repair it. The reliability of repairable products is recognized as “reliability in a broad sense of the term”. For repairable products, their serviceability or maintainability is another problem. In addition, reliability of product design is becoming a serious concern for the manufacturing industry. In short, reliability has three senses: i.e. reliability of the product itself, serviceability of the product, and reliability of product design.

3. Intrinsic Reliability and Reliability of Use

Reliability is “built” into products. This is referred to as intrinsic reliability which consists mainly of reliability in the narrow sense.

Product reliability at the user’s site is called “reliability of use”, which consists mainly of reliability in the broad sense. In the relay industry, reliability of use has a significance in aspects of servicing.

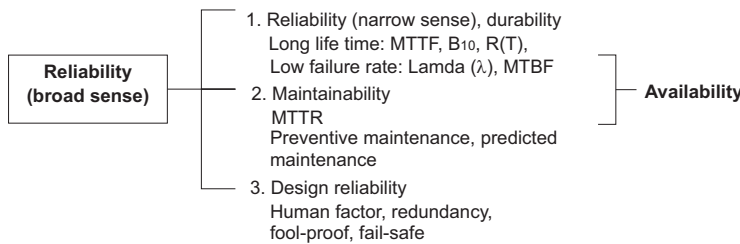

[2] RELIABILITY MEASURES

The following list contains some of the most popular reliability measures:

Reliability measure	Sample representation
Degree of reliability R(T)	99.9%
MTBF	100 hours
MTTF	100 hours
Failure rate λ	20 fit, 1%/hour
Safe life B ₁₀	50 hours

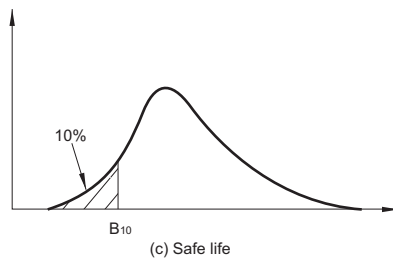

MTBF tells how long a product can be used without the need for repair.

Sometimes MTBF is used to represent the service lifetime before failure.

3. MTTF

MTTF is an acronym of mean time to failure. It indicates the mean time period until a product becomes faulty. MTTF normally applies to unrepairable products such as parts and materials.

The relay is one of such objective of MTTF.

4. Failure Rate

Failure rate includes mean failure rate and momentary failure rate.

Mean failure rate is defined as follows:

Mean failure rate = Total failure count / total operating hours

In general, failure rate refers to momentary failure rate. This represents the probability at which a system, equipment, or part, which has continued normal operation to a certain point of time, becomes faulty in the subsequent specified time period.

Failure rate is often represented in the unit of percent/hours. For parts with low failure rates, “failure unit (Fit) = 10⁻⁹ / hour” is often used instead of failure rate. Percent/count is normally used for relays.

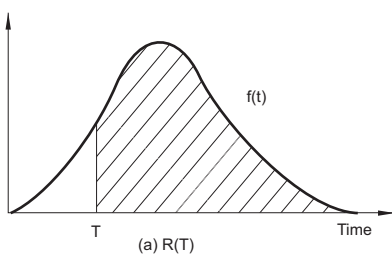

1. Degree of Reliability

Degree of reliability represents percentage ratio of reliability. For example, if none of 10 light bulbs has failed for 100 hours, the degree of reliability defined in, 100 hours of time is 10/10 = 100%. If only three bulbs remained alive, the degree of reliability is 3/10 = 30%.

The JIS Z8115 standard defines the degree of reliability as follows:

The probability at which a system, equipment, or part provides the specified functions over the intended duration under the specified conditions.

2. MTBF

MTBF is an acronym of mean time between failures. It indicates the mean time period in which a system, equipment, or part operates normally between two incidences of repair. MTBF only applies to repairable products.

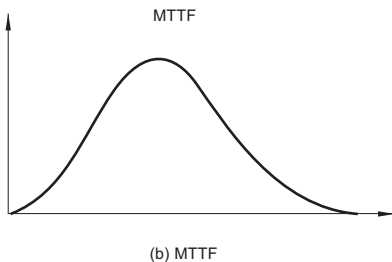

5. Safe Life

Safe life is an inverse of degree of reliability. It is given as value B which makes the following equation true:

$$1 - R(B) = t \%$$

In general, "B[1 - R(B)] = 10%" is more often used. In some cases this

represents a more practical value of reliability than MTTF.

[3] FAILURE

1. What is Failure?

Failure is defined as a state of system, equipment, or component in which part of all of its functions are impaired or lost.

2. Bathtub Curve

Product's failure rate throughout its lifetime is depicted as a bathtub curve, as shown below. Failure rate is high at the beginning and end of its service lifetime.

(I) Initial failure period

The high failure rate in the initial failure period is derived from latent design errors, process errors, and many other causes. Initial failures are screened at manufacturer's site through burn-in process. This process is called debugging, performing aging or screening.

(II) Accidental failure period

The initial failure period is followed by a long period with low, stable failure rate. In this period, called accidental failure period, failures occurs at random along the time axis. While zero accidental failure rate is desirable, this is actually not practical in the real world.

(III) Wear-out failure period

In the final stage of the product's service lifetime comes the wear-out failure period, in which the life of the product expires due to wear of fatigue. Preventive

maintenance is effective for this type of failure. The timing of a relay's wear-out failure can be predicted with a certain accuracy from the past record of uses. The use of a relay is intended only in the accidental failure period, and this period virtually represents the service lifetime of the relay.

3. Weibull Analysis

Weibull analysis is often used for classifying a product's failure patterns and to determine its lifetime. Weibull distribution is expressed by the following equation:

$$f(x) = \frac{m}{\alpha} (\chi - \gamma)^{m-1} e^{-\frac{(\chi - \gamma)^m}{\alpha}}$$

m : Figure parameter

α : Measurement parameter

γ : Position parameter

Weibull distribution can be adopted to the actual failure rate distribution if the three variables above are estimated.

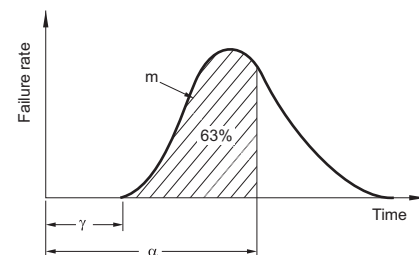

The Weibull probability chart is a simpler alternative of complex calculation formulas. The chart provides the following advantages:

- The Weibull distribution has the closest proximity to the actual lifetime distribution.
- The Weibull probability chart is easy to use.
- Different types of failures can be identified on the chart.

The following describes the correlation with the bathtub curve. The value of the figure parameter "m" represents the type of the failure.

- When $m < 1$: Initial failures
- When $m = 1$: Accidental failures
- When $m > 1$: Wear-out failures

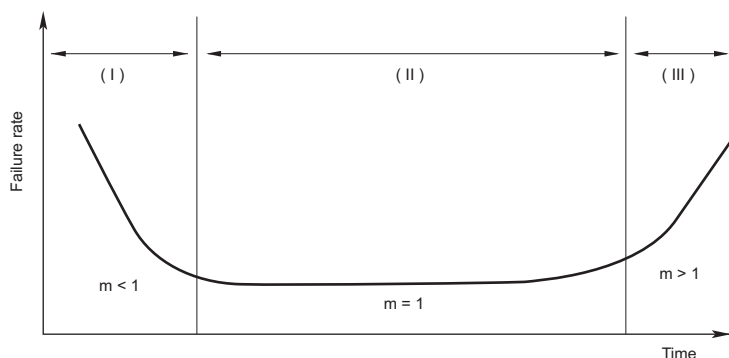

APPLICATIONS OF RELAYS IN ELECTRONIC CIRCUITS

[1] RELAY DRIVE BY MEANS OF A TRANSISTOR

1. Connection Method

If the relay is transistor driven, we recommend using it with a collector connection.

The voltage impressed on the relay is always full rated voltage, and in the OFF time, the voltage is completely zero for avoidance of trouble in use.

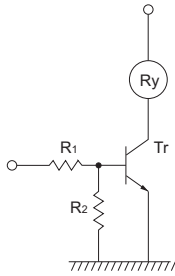

(Good) Collector connection
With this most common connection, operation is stable.

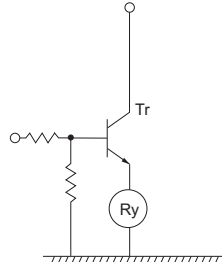

(Care) Emitter connection
When the circumstances make the use of this connection unavoidable, if the voltage is not completely impressed on the relay, the transistor does not conduct completely and operation is uncertain.

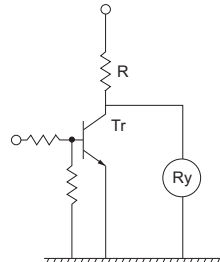

(Care) Parallel connection
When the power consumed by the complete circuit becomes large, consideration of the relay voltage is necessary.

2. Countermeasures for Surge Breakdown Voltage of Relay Control Transistor

If the coil current is suddenly interrupted, a sudden high voltage pulse is developed in the coil. If this voltage exceeds the breakdown voltage of the transistor, the transistor will be degraded, and this will lead to damage. It is absolutely necessary to connect a diode in the circuit as a means of preventing damage from the counter emf.

As suitable ratings for this diode, the current should be equivalent to the average rectified current to the coil, and

the reverse blocking voltage should be about 3 times the value of the power source voltage.

Connection of a diode is an excellent way to prevent voltage surges, but there will be a considerable time delay when the relay is open. If you need to reduce this time delay you can connect between the transistor's collector and emitter a Zener diode that will make the Zener voltage

somewhat higher than the supply voltage.

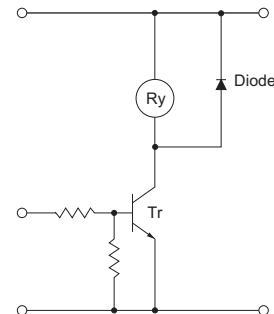

Take care of the "Area of Safe Operation (ASO)"

3. Snap Action

(Characteristic of relay with voltage rise and fall of voltage)

Unlike the characteristic when voltage is impressed slowly on the relay coil, this is the case where it is necessary to impress

the rated voltage in a short time and also to drop the voltage in a short time.

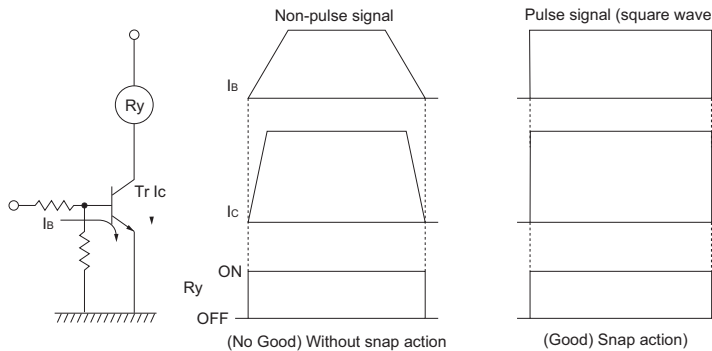

4. Schmidt Circuit (Snap Action Circuit)

(Wave rectifying circuit)

When the input signal does not produce a snap action, ordinarily a Schmidt circuit is used to produce safe snap action.

Characteristic points

- The common emitter resistor R_E must have a value sufficiently small

Applications of Relays in Electronic Circuits

compared with the resistance of the relay coil.

- Due to the relay coil current, the difference in the voltage at point P when Tr₂ is conducting and at point P when Tr₁ is conducting creates hysteresis in the detection capability of Schmidt circuit, and care must be taken in setting the values.
- When there is chattering in the input signal because of waveform oscillation, an CR time constant circuit should be inserted in the stage before the

Schmidt trigger circuit. (However, the response speed drops.)

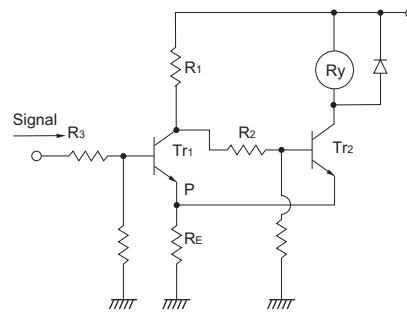

5. Avoid Darlington Connections.

(High amplification)

This circuit is a trap into which it is easy to fall when dealing with high circuit

technology. This does not mean that it is immediately connected to the defect, but it is linked to troubles that occur after long periods of use and with many units in operation.

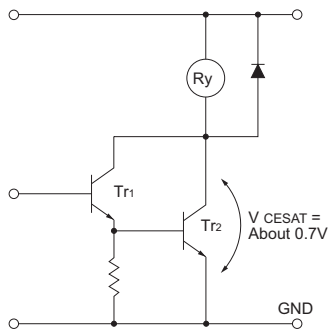

(No good) Darlington connection
(Due to excessive consumption of power, heat is generated.)
(A strong Tr₁ is necessary)

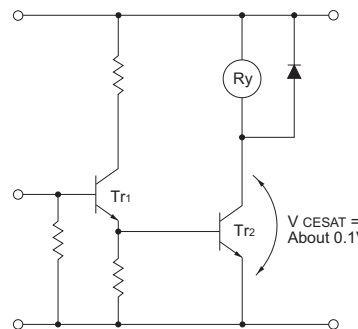

(Good) Emitter connection
(Tr₂ conducts completely.)
(Tr₁ is sufficient for signal use.)

6. Residual Coil Voltage

In switching applications where a semiconductor (transistor, UJT, etc.) is connected to the coil, a residual voltage is retained at the relay coil which may cause incomplete restoration and faulty operation. By using DC coils, there may be a reduction in; the danger of incomplete restoration, the contact pressure, and the vibration resistance. This is because the drop-out voltage is 10% or more of the rated voltage, a low value compared to that for AC coil, and also there is a tendency to increase the life by lowering the drop-out voltage. When the signal from the transistor's collector is taken and used to drive another circuit as shown in the figure on the right, a minute dark current flows to the relay even if the transistor is off. This may cause the problems described above.

Connection to the next stage through collector

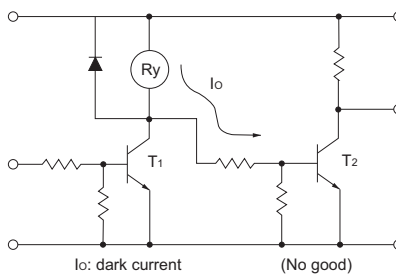

Applications of Relays in Electronic Circuits

[2] RELAY DRIVE BY MEANS OF SCR

1. Ordinary Drive Method

For SCR drive, it is necessary to take particular care with regard to gate sensitivity and erroneous operation due to noise.

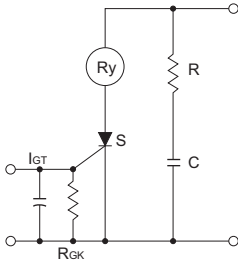

I_{GT} : There is no problem even with more than 3 times the related current.

R_{GK} : 1K Ω must be connected.

R, C : This is for prevention of ignition error due to a sudden rise in the power source or to noise. (dv/dt countermeasure)

2. Caution points regarding ON/OFF control circuits

(When used for temperature or similar control circuits)

When the relay contacts close simultaneously with an AC single phase power source, because the electrical life of the contacts suffers extreme shortening, care is necessary.

- When the relay is turned ON and OFF using a SCR, the SCR serves as a half wave power source as it is, and there are ample cases where the SCR is easily restored.
- In this manner the relay operation and restoration timing are easily synchronized with the power source frequency, and the timing of the load switching also is easily synchronized.

- When the load for the temperature control is a high current load such as a heater, the switching can occur only at peak values and it can occur only at zero phase values as a phenomenon of this type of control. (Depending upon the sensitivity and response speed of the relay)
- Accordingly, either an extremely long life or an extremely short life results with wide variation, and it is necessary to take care with the initial device quality check.

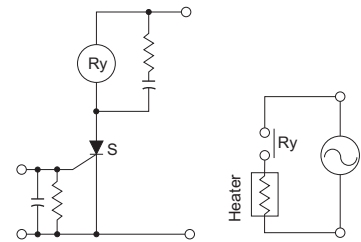

[3] RELAY DRIVE FROM EXTERNAL CONTACTS

Relays for PC board use have high sensitivity and high speed response characteristics, and because they respond sufficiently to chattering and bouncing, it is necessary to take care in their drive.

When the frequency of use is low, with the delay in response time caused by a condenser, it is possible to absorb the chattering and bouncing.

(However, it is not possible to use only a condenser. A resistor should also be used with the capacitor.)

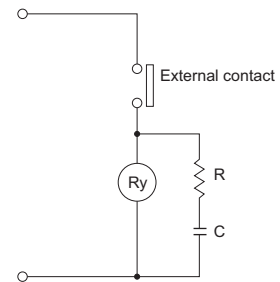

[4] LED SERIES AND PARALLEL CONNECTIONS

1) In series with relay

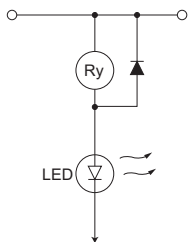

Power consumption:
In common with relay (Good)
Defective LED:
Relay does not operate (No Good)
Low voltage circuit:
With LED, 1.5V down (No good)
No. of parts: (Good)

2) R in parallel with LED

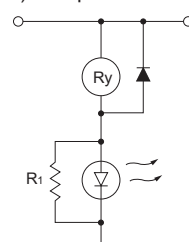

Power consumption:
In common with relay (Good)
Defective LED:
Relay operate (Good)
Low voltage circuit:
With LED, 1.5V down (No good)
No. of parts: R₁ (Care)

3) In parallel connection with relay

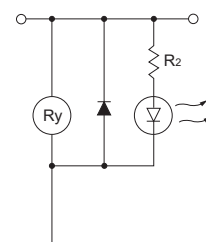

Power consumption:
Current limiting resistor R₂ (Care)
Defective LED:
Relay operate stable (Good)
Low voltage circuit: (Good)
No. of parts: R₂ (Care)

[5] ELECTRONIC CIRCUIT DRIVE BY MEANS OF A RELAY

1. Chatterless Electronic Circuit

Even though a chatterless characteristic is a feature of relays, this is to the fullest extent a chatterless electrical circuit, much the same as a mercury relay. To meet the requirement for such circuits as the input to a binary counter, there is an electronic chatterless method in which chattering is absolutely not permissible. Even if chattering develops on one side, either the N.O. side contacts or the N.C. side contacts, the flip flop does not reverse, and the counter circuit can be fed pulsed without a miss. (However, bouncing from the N.O. side to N.C. side must be absolutely avoided.)

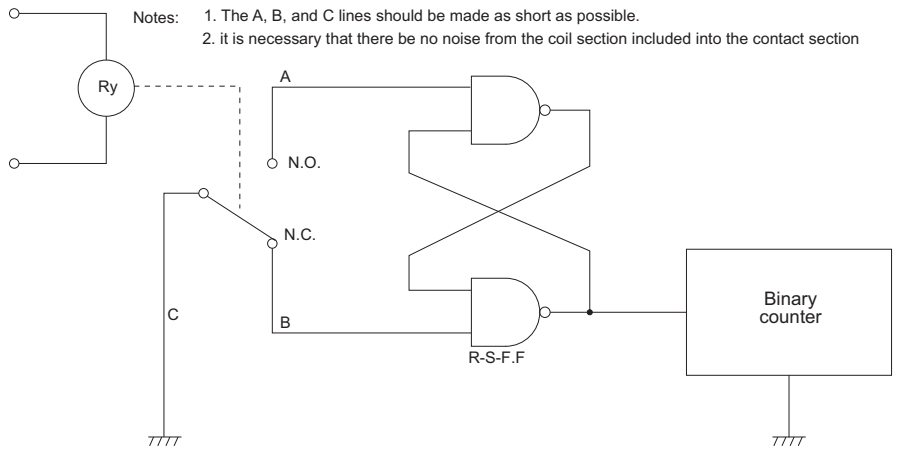

2. Triac Drive

When an electronic circuit using a direct drive from a triac, the electronic circuit will not be isolated from the power circuit, and because of this, troubles due to erroneous operation and damage can develop easily. The introduction of a relay drive is the most economical and most effective solution. (Photo coupler and pulse transformer circuits are complicated.)

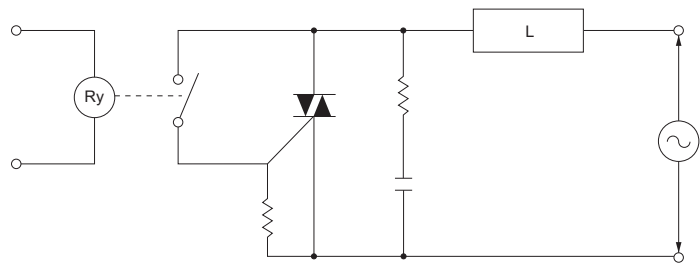

Also, compared to switching a direct load with a relay, long life and reduced arc noise can be achieved.

When a zero cross switching characteristic is necessary, a solid state relay (SSR) should be used.

[6] POWER SOURCE CIRCUIT

1. Constant Voltage Circuit

In general, electronic circuits are extremely vulnerable to such phenomena as power supply ripples and voltage fluctuations. Although relay power supplies are not as vulnerable as electronic circuits, please keep both ripples and the regulation within the specification.

If power supply voltage fluctuations are large, please connect a stabilized circuit or constant-voltage circuit as shown in Figure 17.

If the relay power consumption is great, satisfactory results can be achieved by implementing a circuit configuration as shown in Figure 18.

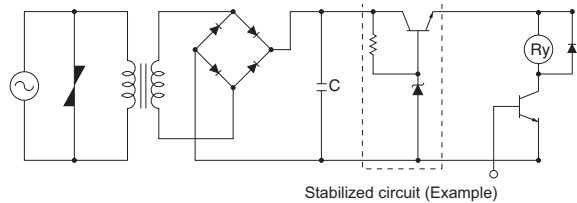

Figure 17

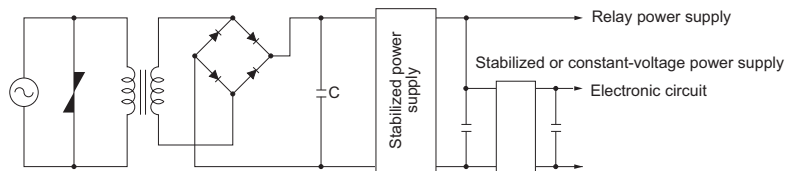

Figure 18

Applications of Relays in Electronic Circuits

2. Prevention of Voltage Drop Due to Rush Current

In the circuit shown in Figure 19, rush current flows from the lamp or capacitor. The instant the contacts close, the voltage drops and the relay releases or chatters.

In this case it is necessary to raise the transformer's capacity or add a smoothing circuit.

Figure 20 shows an example of the modified circuit.

Figure 21 shows a battery-powered version.

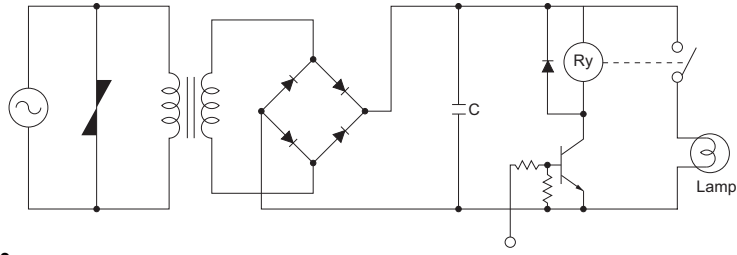

Figure 19

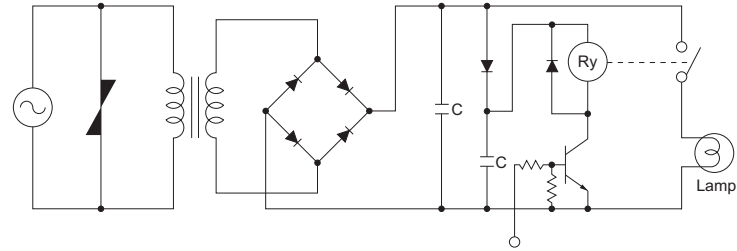

Figure 20

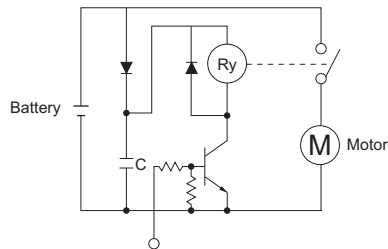

Figure 21

[7] PC BOARD DESIGN CONSIDERATIONS

1. Pattern Layout for Relays

Since relays affect electronic circuits by generating noise, the following points should be noted.

Keep relays away from semiconductor devices. Design the pattern traces for shortest lengths. Place the surge absorber (diode, etc.) near the relay coil.

Avoid routing pattern traces susceptible to noise (such as for audio signals) underneath the relay coil section. Avoid through-holes in places which cannot be seen from the top (e.g. at the base of the relay). Solder flowing up through such a hole may cause damage such as a

broken seal. Even for the same circuit, pattern design considerations which minimize the influence of the on/off operations of the relay coil and lamp on other electronic circuits are necessary.

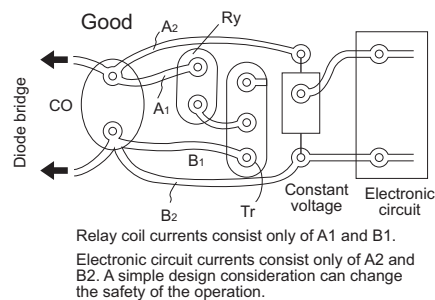
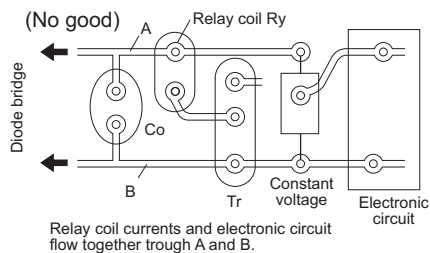

2. Hole and land diameter

The hole diameter and land are made with the hole slightly larger than the lead wire so that the component may be inserted easily. Also, when soldering, the solder will build up in an eyelet condition, increasing the mounting strength.

The standard dimensions for the hole diameter and land are shown in the table.

Standard dimensions for hole and land diameter

mm inch

Standard hole diameter	Tolerance	Land diameter
0.8 .031	$\pm 0.1 \pm .039$	2.0 to 3.0 .079 to .118
1.0 .039		
1.2 .047		3.5 to 4.5 .138 to .177
1.6 .063		

Remarks

1. The hole diameter is made 0.2 to 0.5mm .008 to .020inch larger than the lead diameter. However, if the jet method (wave type, jet type) of soldering is used, because of the fear of solder passing through to the component side, it is more suitable to make the hole diameter equal to the lead diameter +0.2mm.
2. The land diameter should be 2 to 3 times the hole diameter.
3. Do not put more than 1 lead in one hole.

3. Expansion and shrinkage of copperclad laminates

Because copperclad laminates have a longitudinal and lateral direction, the manner of punching fabrication and layout must be observed with care. The expansion and shrinkage in the longitudinal direction due to heat is 1/15 to 1/2 that in the lateral, and accordingly, after the punching fabrication, the distortion in the longitudinal direction will be 1/15 to 1/2 that of the lateral direction. The mechanical strength in the longitudinal direction is 10 to 15% greater than that in the lateral direction. Because of this difference between the longitudinal and lateral directions, when products having long configurations are to be fabricated, the lengthwise direction of the configuration should be made in the longitudinal direction, and PC boards having a connector section should be

made with the connector along the longitudinal side.

Example: As shown in the drawing below, the 150mm 5.906 inch direction is taken as the longitudinal direction

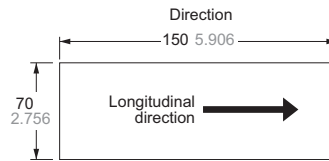

Also, as shown in the drawing below, when the pattern has a connector section, the direction is taken as shown by the arrow in the longitudinal direction

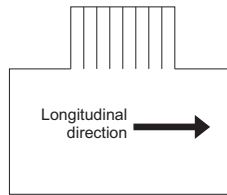

4. When it is necessary to use hand soldering for one part of a component after dip soldering has been done

By providing a narrow slot in the circular part of the foil pattern, the slot will prevent the hole from being plugged with solder.



5. When the PC board itself is used as a connector

- The edge should be beveled. (This prevents peeling of the foil when the board is inserted into its socket.)
- When only a single side is used as the connector blade, if there is distortion in the PC board, contact will be defective.
- Care should be taken.

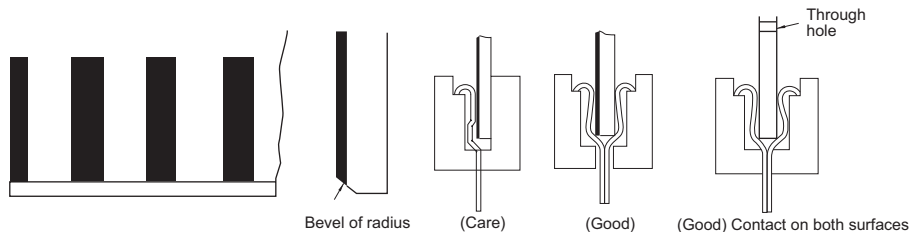

Applications of Relays in Electronic Circuits

6. PC Board Reference Data

This data has been derived from samples of this company's products. Use this data as a reference when designing PC boards.

• Conductor width

The allowable current for the conductor was determined from the safety aspect and the effect on the performance of the conductor due to the rise in saturation temperature when current is flowing. (The narrower the conductor width and

the thinner the copper foil, the larger the temperature rise.) For example, too high a rise in temperature causes degradation of the characteristic and color changes of the laminate. In general, the allowable current of the conductor is determined so that the rise in temperature is less than 10°C. It is necessary to design the conductor width from this allowable conductor current.

Figure 22, Figure 23, Figure 24 show the

relationship between the current and the conductor width for each rise in temperature for different copper foils. It is also necessary to give consideration to preventing abnormal currents from exceeding the destruction current of the conductor.

Figure 25 shows the relationship between the conductor width and the destruction current.

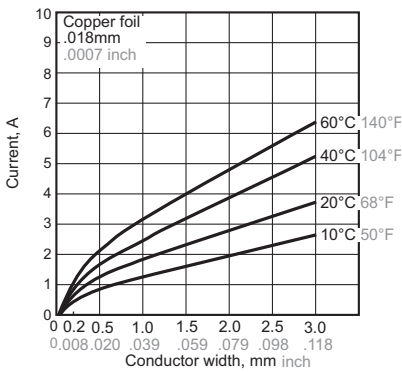

Figure 22

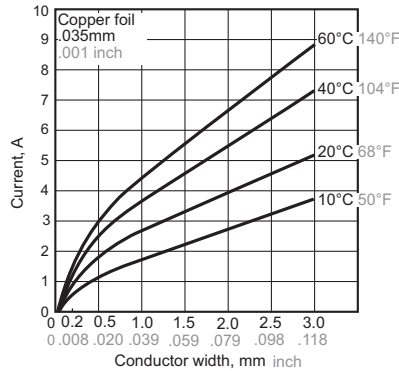

Figure 23

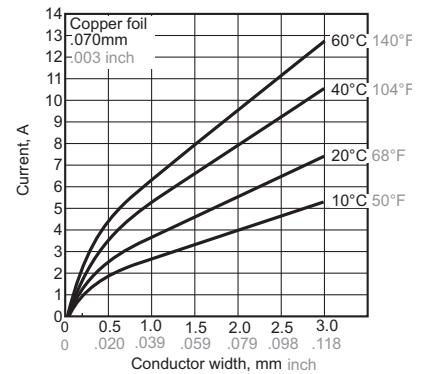

Figure 24

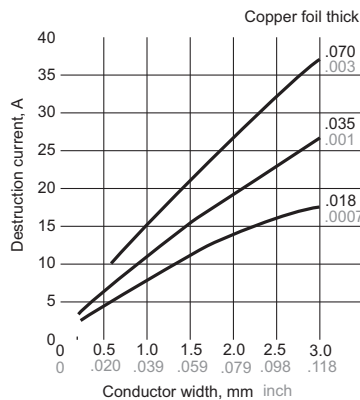

Figure 25

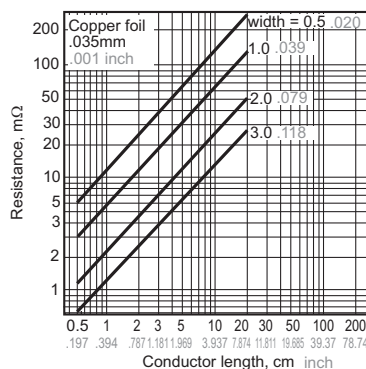

Figure 26

• Space between conductors

Figure 27 shows the relationship between the spacing between conductors and the destruction voltage. This destruction voltage is not the destruction voltage of the PC board; it is the flash over voltage (insulation breakdown voltage of the space between circuits.) Coating the surface of the conductor with an insulating resin such as a solder resist increases the flash over voltage, but because of the pin holes of the solder resist, it is necessary to consider the conductor destruction voltage without the solder resist. In fact, it is necessary to add an ample safety factor when determining the spacing between conductors. Table shows an example of a design for the spacing between conductors. (Taken from the JIS C5010 standards.) However, when the product is covered by the electrical products control law, UL standards or other safety

standards, it is necessary to conform to the regulations.

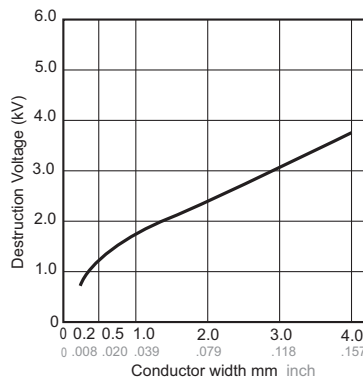

Figure 27

Example of conductor spacing design

Maximum DC and AC Voltage Between Conductors (V)	Minimum Conductor Spacing (mm inch)
0 to 50	0.381 .015
51 to 150	0.635 .025
151 to 300	1.27 .050
301 to 500	2.54 .100
500 or more	Calculated at 0.00508 mm/V

RELAY SOLDERING AND CLEANING GUIDELINES

In keeping with making devices compact, it is becoming more common to weld the relay to a PC board along with the semiconductors instead of using the previous plug-in type in which relays were plugged into sockets. With this style, loss of function may occur because

of seepage into the relay of flux, which is applied to the PC board. Therefore, the following precautions are provided for soldering a relay onto a PC board. Please refer to them during installation in order to avoid problems.

The type of protective structure will determine suitability for automatic soldering or automatic cleaning. Please review the parts on construction and characteristics. See "Configuration and Construction" on page 1.

1. Mounting of relay

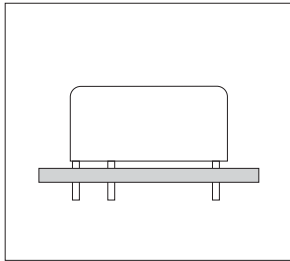

- Avoid bending the terminals to make the relay self-clinching. Relay

performance cannot be guaranteed if the terminals are bent. Self-clinching terminal types are available depending on the type of relay.

- Correctly drill the PC board according to the given PC board pattern illustration.
- Stick packaging is also available for automatic mounting, depending on the type of relay. (Be sure that the relays

don't rattle.) Interference may occur internally if the gripping force of the tab of the surface mounting machine is too great. This could impair relay performance.

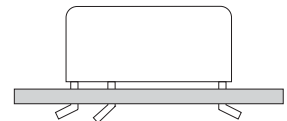

Bad example

2. Flux application

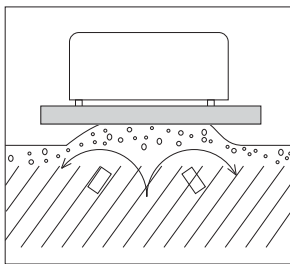

- Adjust the position of the PC board so that flux does not overflow onto the top of it. This must be observed especially for dust-cover type relays.
- Use rosin-based non-corrosive flux.
- If the PC board is pressed down into a flux-soaked sponge as shown on the right, the flux can easily penetrate a dust-cover type relay. Never use this method. Note that if the PC board is

pressed down hard enough, flux may even penetrate a flux-resistant type relay.

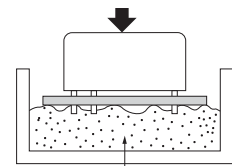

Bad example

3. Preheating

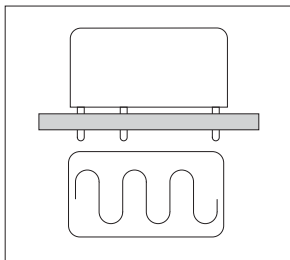

- Be sure to preheat before using automatic soldering. For dust-cover type relays and flux-resistant type relays, preheating acts to prevent the penetration of flux into the relay when soldering. Solderability also improves.

- Preheat according to the following conditions.

Temperature	120°C 248°F or less
Time	Within approx. 2 minutes

- Note that long exposure to high temperatures (e.g. due to a malfunctioning unit) may affect relay characteristics.

4. Soldering

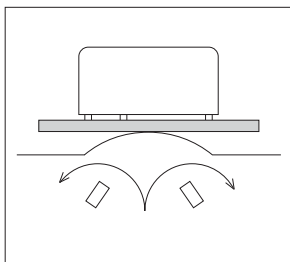

- **Automatic soldering**
- Flow solder is the optimum method for soldering.
- Adjust the level of solder so that it does not overflow onto the top of the PC board.
- Unless otherwise specified, solder under the following conditions depending on the type of relay.

degrade due to the high thermal capacity of these boards.

- **Hand soldering**

Keep the tip of the soldering iron clean.

Soldering Iron	30W to 60W
Iron Tip Temperature	350°C 662°F
Soldering Time	Within approx. 3 seconds

Solder temperature	260°C±5°C 500°F±41°F
Soldering time	Within approx. 6 seconds

- Please take caution with multi-layer boards. Relay performance may

Relay Soldering and Cleaning Guidelines

5. Cooling

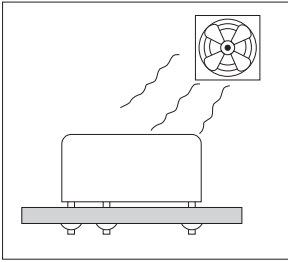

- **Automatic soldering**
- Immediate air cooling is recommended to prevent deterioration of the relay and surrounding parts due to soldering heat.
- Although the environmentally sealed type relay (plastic sealed type, etc.) can be cleaned, avoid immersing the relay into cold liquid (such as cleaning solvent) immediately after soldering. Doing so may deteriorate the sealing performance.

• Hand soldering

6. Cleaning

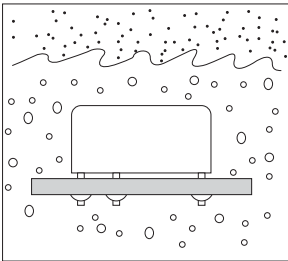

- Do not clean dust-cover type relays and flux-resistant type relays by immersion. Even if only the bottom surface of the PC board is cleaned (e.g. with a brush), careless cleaning may cause cleaning solvent to penetrate the relay.
- Plastic sealed type relays can be cleaned by immersion. Use a Freon- or alcohol-based cleaning solvent. Use of other cleaning solvents (e.g. Trichlene,

chloroethene, thinner, benzyl alcohol, gasoline) may damage the relay case.

- Cleaning with the boiling method is recommended. Avoid ultrasonic cleaning on relays. Use of ultrasonic cleaning may cause breaks in the coil or slight sticking of the contacts due to the ultrasonic energy.
- Do not cut the terminals. When terminals are cut, breaking of coil wire and slight sticking of the contacts may occur due to vibration of the cutter.

7. Coating

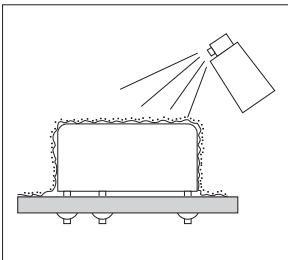

- If the PC board is to be coated to prevent the insulation of the PC board from deteriorating due to corrosive gases and high temperatures, note the following.
- Do not coat dust-cover type relays and flux-resistant type relays, since the coating material may penetrate the relay and cause contact failure. Or, mount the relay after coating.
- If the relay and all components (e.g. ICs) are to be coated, be sure to carefully check the flexibility of the

coating material. The solder may peel off from thermal stress.

- Depending on the type, some coating materials may have an adverse effect on relays. Furthermore, solvents (e.g. xylene, toluene, MEK, I.P.A.) may damage the case or chemically dissolve the epoxy and break the seal. Select coating materials carefully.
- If the relay and all components (e.g. ICs) are to be coated, be sure to carefully check the flexibility of the coating material. The solder may peel off from thermal stress.

Type	Suitability for Relays	Features
Epoxy-base	Good	<ul style="list-style-type: none"> • Good electrical insulation. • Although slightly difficult to apply, does not affect relay contacts.
Urethane-base	Care	<ul style="list-style-type: none"> • Good electrical insulation, easy to apply. • Solvent may damage case. Check before use.
Silicone-base	No Good	<ul style="list-style-type: none"> • Silicone gas becomes the cause of contact failure. Do not use the silicone-base type.

SMT SOLDERING GUIDELINES

CAUTIONS FOR SURFACE MOUNT RELAY INSTALLATION

To meet the market demand for downsizing to smaller, lighter, and thinner products, PC boards also need to proceed from Insertion mounting to

surface mounting technology. To meet this need, we offer a line of surface mount relays. The following describes some cautions required for surface

mount relay installation to prevent malfunction and incorrect operation.

[1] What is a Surface Mount Relay?

1. From IMT to SMT

Conventional insertion mount technology (IMT) with some 30 years of history is now being replaced with surface mount technology (SMT).

Solid-state components such as resistors, ICs, and diodes can withstand

high heat stresses from reflow soldering because they use no mechanical parts. In contrast, the conventional electro-mechanical relays consisting of solenoid coils, springs, and armatures are very sensitive to thermal stress from reflow soldering.

We applied the experience gained from our advanced relay technologies to produce high-performance electromagnetic relays compatible with surface mount technologies such as IRS and VPS.

• Insertion Mount Technology (IMT) vs. Surface Mount Technology (SMT)

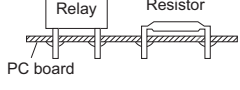
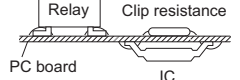
<p>Insertion Mounting Technology (IMT)</p>	<p>Components' leads are inserted into lead holes drilled into the PC board and are soldered to copper pads on the other side of the board using flow-soldering techniques.</p>	
<p>Surface Mount Technology (SMT)</p>	<p>Components are placed on copper pads pre-coated with paste solder and the board assembly is heated to solder the components on the pads (reflow soldering).</p>	

2. Features and Effects

Features	Effects	The surface mount relay is manufactured with the following advanced technologies:
<ul style="list-style-type: none"> • Allows high density mounting • Components can be installed on both sides of a board • Ceramic PC boards can be used 	System downsizing	<ul style="list-style-type: none"> • Heat-resistance encapsulation technique
<ul style="list-style-type: none"> • Compatible with automatic placement by robots • Drilling for lead holes is not required • Compact system designs are possible due to high density mounting 	Overall cost reduction	<ul style="list-style-type: none"> • Gas analysis • Reliability assessment
<ul style="list-style-type: none"> • High heat resistance • Anti-gas measures 	High reliability	<ul style="list-style-type: none"> • Precision molding technique for heat-resistant materials

3. Examples of SMT Applications

The following describes some examples of typical SMT applications:

• Infrared Reflow Soldering (IRS)

IRS is the most popular reflow soldering technology now available for surface mounting. It uses a sheath heater or infrared lamp as its heat source. PC board assemblies are continuously soldered as they are transferred through a tunnel furnace comprised of a preheating, heating, and cooling-stages.

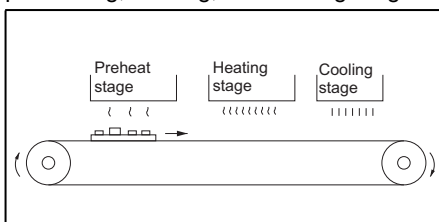

• Vapor Phase Soldering (VPS)

With VPS technology, PCB assemblies are carried through a special inactive solvent, such as Fluorinert FC-70, that has been heated to a vapor state. As the saturated vapor condenses on the PC board surface, the resulting evaporation heat provides the energy for reflow soldering.

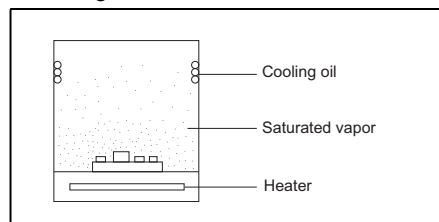

• Belt conveyer reflow furnace

As PCB assemblies are transferred on a thin, heat-resistant belt conveyer, they are soldered by the heat from hotplates placed beneath the conveyer belt.

• Double Wave Soldering (DWS)

Components are glued to the PC board surface. The board assembly is transferred through a molten solder fountain (with the component side facing down), and the components are soldered to the board.

• Other Technologies

Other reflow soldering technologies include those utilizing lasers, hot air, and pulse heaters.

SMT Soldering Guidelines

[2] Cautions for installation

1. Paste Soldering

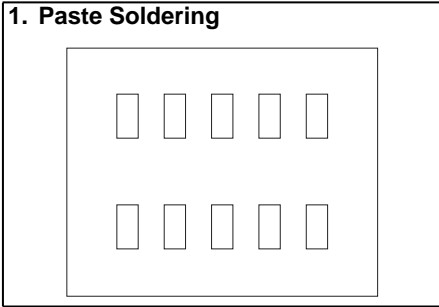

- Mounting pads on PC boards must be designed to absorb placement errors while taking account of solderability and insulation. Refer to the suggested mounting pad layout in the application data for the required relay product.
- Paste solder may be applied on the board with screen printing or dispenser techniques. For either method, the paste solder must be coated to appropriate thickness and shapes to achieve good solder wetting and adequate insulation.

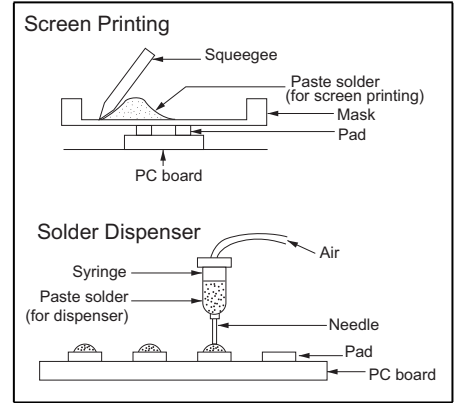

2. Relay Installation

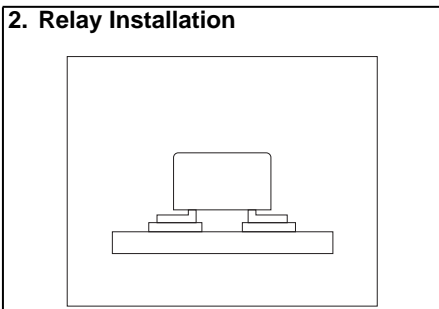

- For small, lightweight components such as chip components, a self-alignment effect can be expected if small placement errors exist. However, this effect is not as expected for electro-mechanical components such as relays, and they require precise positioning on their soldering pads.
- If SMT relays sustain excessive mechanical stress from the placement machine's pickup head, their performance cannot be guaranteed.

- Our SMT relays are supplied in stick packaging compatible with automatic placement processes. We also offer tape packaging at customer request.

Holding Pressure
 Direction A: Less than 9.8 N (less than 1,000 gf)
 Direction B: Less than 9.8 N (less than 1,000 gf)
 Direction C: Less than 9.8 N (less than 1,000 gf)

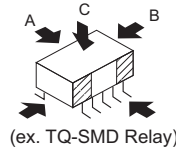

3. Reflow

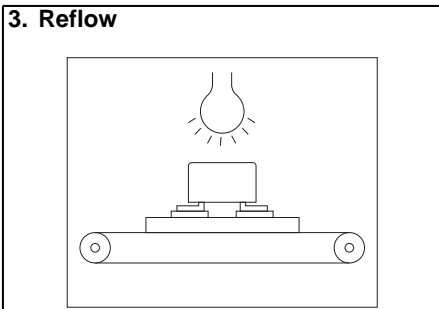

- IRS technique

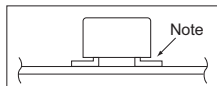
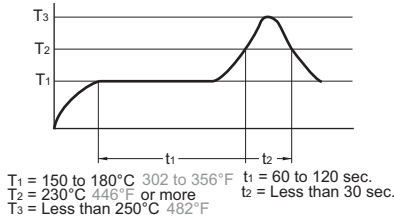

- It is recommended that the soldered pad be immediately cooled to prevent thermal damage to the relay and its associated components.
- While surface mount relays are solvent washable, do not immerse the relay in cold cleaning solvent immediately after soldering.

- Manual soldering

- Soldering iron tip temperature: $350^\circ\text{C } 662^\circ\text{F}$
- Soldering iron wattage: 30 to 60 watts
- Soldering time: Less than 3 sec.

- Others

When a soldering technique other than above is to be used (hot air, hotplate, laser, or pulse heater technique), carefully investigate the suitability of the technique.

Notes:

- The soldering temperature profile indicates the pad temperature. In some cases, the ambient temperature may be greatly increased. Check for the specific mounting condition.
- Please use promptly once the anti-humidity pack is opened (Signal relay: with in 3 days, Max. $30^\circ\text{C } 86^\circ\text{F}/60\%\text{RH}$). If left with the pack open, the relay will absorb moisture which will cause thermal stress when reflow mounting and thus cause the case to expand. As a result, the seal may break.

Reflow soldering under inadequate soldering conditions may result in unreliable relay performance or even physical damage to the relay (even if the relay is of surface mount type with high heat resistance).

Example of Recommended Soldering Condition for Surface Mount Relays.

4. Cleaning

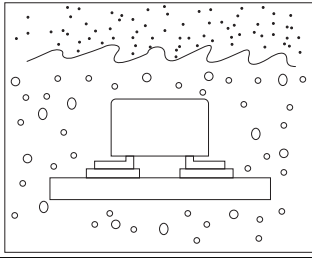

- The surface mount relays are solvent washable. Use alcohol or an equivalent solvent for cleaning.
- Boiled cleaning is approved for surface mount relays. Ultrasonic cleaning may cause coil damage or light contact sticking.