

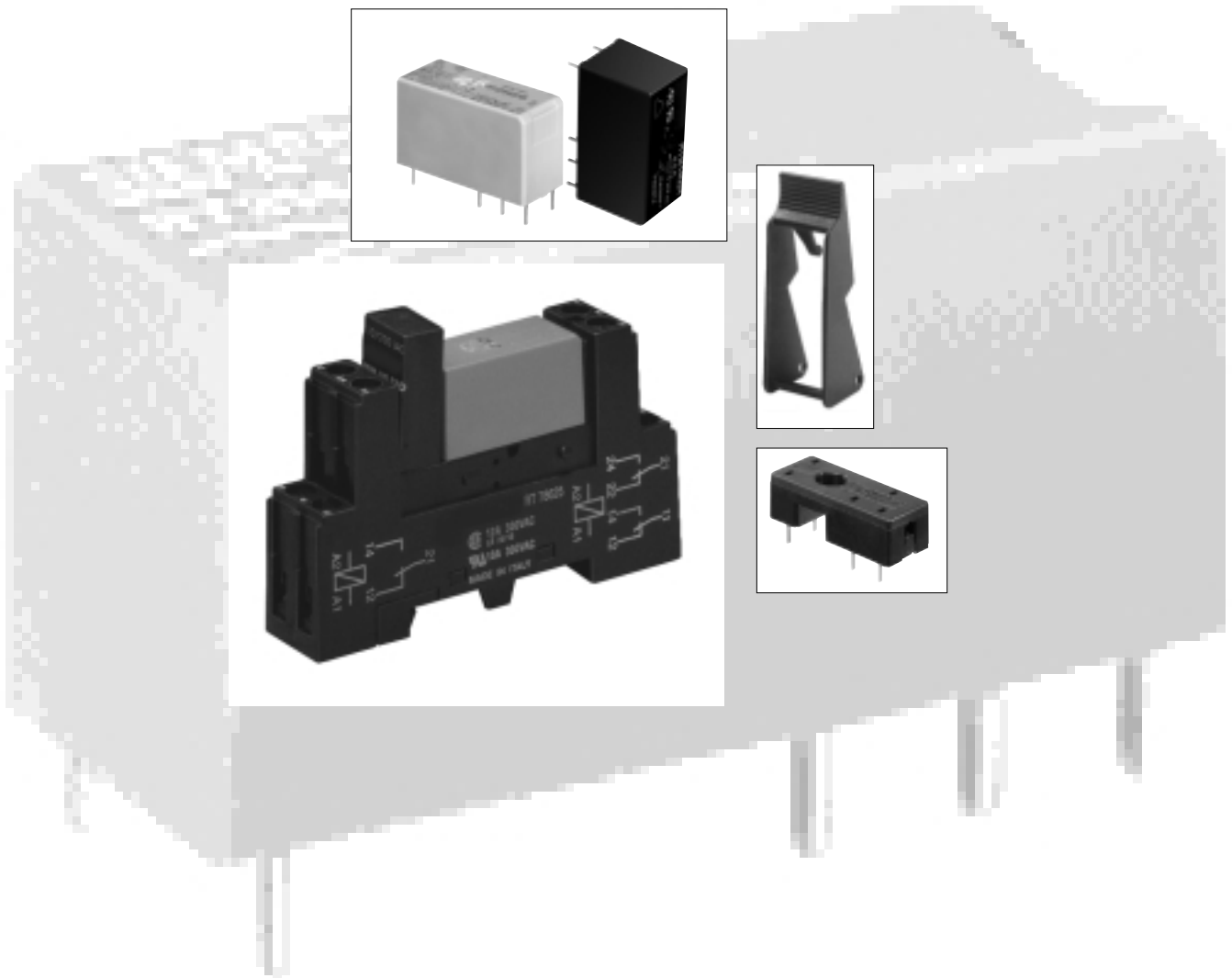

# RT series

Miniature Printed Circuit Board Relays, Sockets and Accessories





# RT series (DC Coil)

## 16 Amp PC Board Miniature Relay

Meets VDE 10mm Spacing, 5KV Dielectric

UL File E22575

CS File LR15734

NR 6106

### Features

- SPST through DPDT contact arrangements.
- Immersion cleanable and flux tight versions available.
- VDE 10mm spacing, 5kV dielectric, coil to contacts.
- UL Class F coil insulation system.
- Conforms to UL 508, 1873, 353 and 1950.
- Low profile; 15.7mm height.
- Sensitive coil; 400mW.
- Withstand surge voltage of 10,000V.

### Contact Data

**Arrangements:** 1 Form A (SPST-NO) Wiring Diagram Code 1, 3.  
 2 Form A (DPST-NO) Wiring Diagram Code 5.  
 1 Form C (SPDT) Wiring Diagram Code 1, 3.  
 2 Form C (DPDT) Wiring Diagram Code 5.

**Material:** Silver-nickel 90/10.

**Minimum Load:** 12V/100mA.

**Expected Mechanical Life:** 10 million operations.

**Initial Contact Resistance:** 100 milliohms max @ 1A 12VDC.

**Designed to meet UL/CSA/VDE ratings with relay properly vented. Remove vent nib after soldering and cleaning.**

### UL/CSA/VDE Ratings @ 25°C

Code	NO/NC Load	Type	Operations
1	10A/10A @ 277VAC	Resistive/GP	100K
	10A/10A @ 30VDC	Resistive	100K
	12A/12A @ 250VAC	Resistive/GP	30K
	12A/12A @ 30VDC	Resistive	30K
	3/4 HP @ 480VAC*	Motor	6K
	1/2 HP @ 240VAC*	Motor	6K
	1/3 HP @ 120VAC*	Motor	6K
	48 LRA/10 FLA @ 240VAC*	Motor	30K
	TV-3 @ 120VAC*	Tungsten	25K
	A300, 720VA @ 240VAC*	Pilot Duty	30K
3	16A/16A @ 250VAC	Resistive/GP	50K
	20A/20A @ 277VAC	Resistive/GP	30K
	20A/20A @ 24VDC	Resistive	30K
	16A/16A @ 30VDC	Resistive	30K
	1 HP @ 480VAC*	Motor	6K
	1 HP @ 240VAC*	Motor	6K
	1/2 HP @ 120VAC*	Motor	6K
	60 LRA/10 FLA @ 250VAC*	Motor	30K
	TV-5 @ 120VAC*	Tungsten	25K
	A300, 720VA @ 240VAC*	Pilot Duty	30K
B300, 360VA @ 240VAC**	Pilot Duty	30K	
5	8A/8A @ 277VAC	Resistive/GP	100K
	8A/8A @ 30VDC	Resistive	100K
	10A/10A @ 250VAC	Resistive/GP	30K
	10A/10A @ 30VDC	Resistive	30K
	1/2 HP @ 240VAC*	Motor	6K
	1/4 HP @ 120VAC*	Motor	6K
	34.8 LRA/6 FLA @ 120VAC*	Motor	30K
	17.4 LRA/5 FLA @ 240VAC*	Motor	30K
	B300, 360VA @ 240VAC*	Pilot Duty	30K
	TV-3 @ 120VAC*	Tungsten	25K

\* Form A only

\*\* Form B only

### Initial Dielectric Strength

**Between Open Contacts:** >1,000VAC (1 minute).

**Between Poles (code 5):** >2,500VAC (1 minute).

**Between Coil and Contacts:** >5,000VAC (1 minute).

**Surge Voltage (DC):** >10,000VAC x (1.2 x 50 µsec).

### Coil Data @ 25°C

**Voltage:** 5 to 48VDC.

**Nominal Power @ 25°C:** 400mW.

**Duty Cycle:** Continuous.

**Initial Insulation Resistance:** 10,000 megohms, min., at 25°C, 500VDC and 50% rel. humidity.

### Coil Data @ 25°C

Nominal Voltage VAC	DC Resistance in Ohms ±10%	Must Operate Voltage VAC	Nominal Coil Current (mA) - 50/60Hz.
005	62	3.5	80
006	90	4.2	66.7
009	202	6.3	44.4
012	360	8.4	33.3
018	810	12.6	22.2
024	1,440	16.8	16.7
048	5,760	33.6	8.3

### Max. Ambient Temp. vs. Coil Voltage

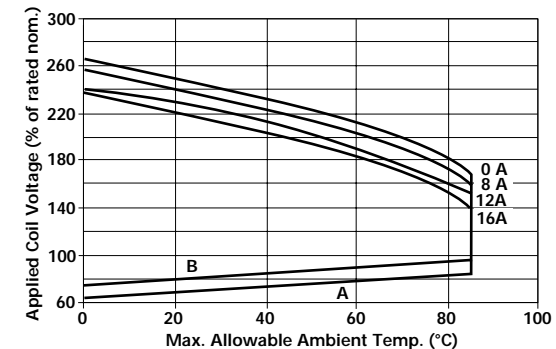

A: Coil temperature = Ambient temperature.

B: 110% of nominal coil voltage at rated contact load.

### Operate Data @ 25°C

**Must Operate Voltage(DC):** 70% of nominal.

**Must Release Voltage(DC):** 10% of nominal.

**Operate Time (Excluding Bounce):**

7 ms, typ., 15ms max. at nom. voltage.

**Release Time (Excluding Bounce):**

3 ms, typ., 6ms max. at nom. voltage.

### Environmental Data

**Temperature Range:**

**Storage:** -40°C to +105°C.

**Operating:** -40°C to +85°C at rated current.

**Vibration, Operational**

N.O.:0.065" (1.65mm) max. excursions from 10 - 55 Hz:

N.C.:0.032" (0.82mm) max. excursions from 10 - 55 Hz:

with no contact opening >10µs

### Mechanical Data

**Termination:** Printed circuit terminals.

**Enclosures:** RT 1, 3, 4: Flux-tight, top vented, plastic case.

RT B, D, E: Immersion cleanable, plastic case.

**Weight:** 0.35 oz. (10g) approximately.

**Ordering Information (DC Coil Models)**

<b>Typical Part Number</b> ▶	<b>RT</b>	<b>B</b>	<b>3</b>	<b>4</b>	<b>012</b>	<b>F</b>
<b>1. Basic Series:</b> RT = Miniature, printed circuit board relay.						
<b>2. Enclosure:</b> 1 = 1 pole 12A, Pinning 3.5mm, flux-tight (Code 1).      B = 1 pole 12A, Pinning 3.5mm, sealed (Code 1). 3 = 1 pole 16A, Pinning 5mm, flux-tight (Code 3).      D = 1 pole 16A, Pinning 5mm, sealed (Code 3). 4 = 2 pole 8A, Pinning 5mm, flux-tight (Code 5).      E = 2 pole 8A, Pinning 5mm, sealed (Code 5).						
<b>3. Contact Arrangement:</b> 1 = 1 Form C (SPDT) (Requires wiring diagram codes 1 or 3.) 2 = 2 Form C (DPDT) (Requires wiring diagram code 5.) 3 = 1 Form A (SPST-NO) (Requires wiring diagram codes 1 or 3.) 4 = 2 Form A (DPST-NO) (Requires wiring diagram code 5.)						
<b>4. Contact Material:</b> 4 = Silver-nickel 90/10 (standard stock).						
<b>5. Coil Voltage:</b> 005 = 5VDC      009 = 9VDC      018 = 18VDC      048 = 48VDC 006 = 6VDC      012 = 12VDC      024 = 24VDC						
<b>5. Coil Insulation Classification</b> F = UL Class F, Siemens Brand      Leave Blank = UL Class A, Schrack Brand						

**Stock Items**

RT114012F	RTB14012F	RTB34024F	RTD14005F	RTD34012F	RTE24005F	RTE44012F
RT114024F	RTB14024F	RT314012F	RTD14012F	RT424012F	RTE24012F	RTE44024F
RTB14005F	RTB34012F	RT314024F	RTD14024F	RT424024F	RTE24024F	

**Outline Dimensions**

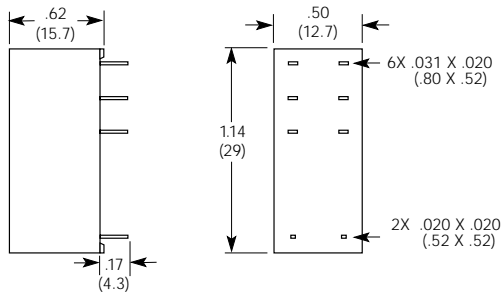

**Breaking Capacity**

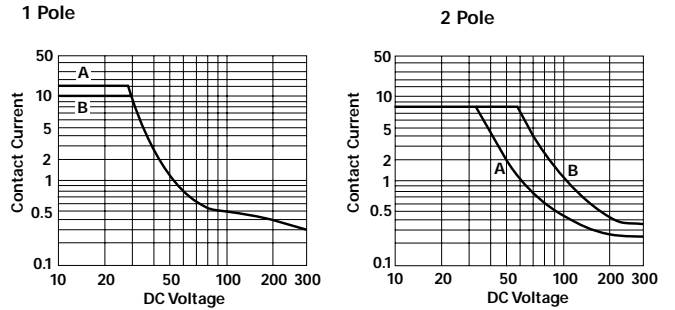

A: 16A Version.  
B: 12A Version.

A: 1 Contact.  
B: 2 Contacts in series.

**PC Board Layouts (Bottom View)**

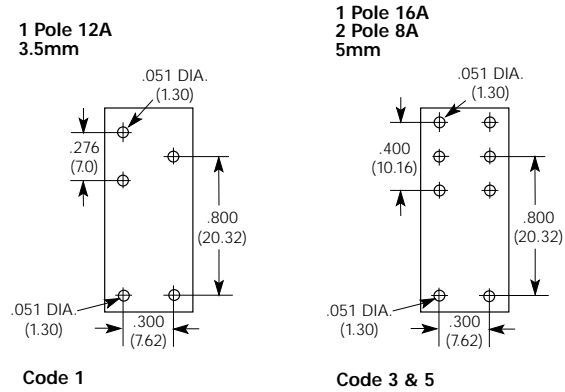

Code 1

Code 3 & 5

Note: On single throw models, only necessary terminals are present.

**Contact Life for Resistive AC Load (Typical)**

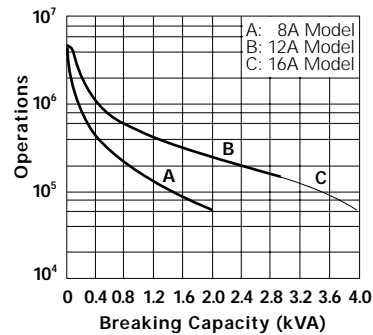

Note: Data from 250VAC @ 70°C.

**Wiring Diagrams (Bottom View)**

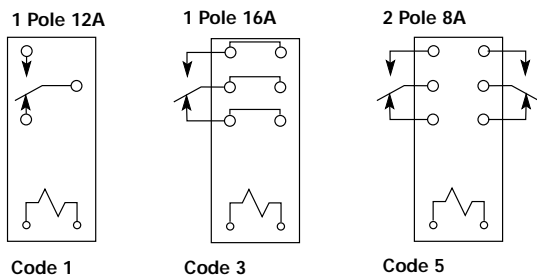

Code 1

Code 3

Code 5

Note: On single throw models, only necessary terminals are present.



# RT series (AC Coil)

## 16 Amp Miniature Printed Circuit Board Relay

Meets VDE 10mm Spacing, 5KV Dielectric

File E38891

File LR14385

NR 6106

### Features

- SPST through DPDT contact arrangements.
- Immersion cleanable and flux tight versions available.
- Meets VDE 10mm spacing, 5kV dielectric, coil to contacts.
- Conforms to UL 508, 1873 and 353.

### Contact Data

**Arrangements:** 1 Form A (SPST-NO) Wiring Diagram Code 1, 3.  
 2 Form A (DPST-NO) Wiring Diagram Code 5.  
 1 Form C (SPDT) Wiring Diagram Code 1, 3.  
 2 Form C (DPDT) Wiring Diagram Code 5.

**Material:** Silver-nickel 90/10.

**Minimum Load:** 12V/100mA.

**Expected Mechanical Life:** 10 million operations.

Designed to meet UL/CSA/VDE ratings with relay properly vented. Remove vent nib after soldering and cleaning.

### UL/CSA Ratings @ 25°C:

Code	NO/NC Load	Type	Operations
1	12A NO @ 240VAC	GP	30K
	10A/5A @ 240VAC	Resistive/GP	100K
	8A @ 28VDC	Resistive	30K
	1 HP @ 240VAC*	Motor	6K
	1/2 HP @ 120VAC*	Motor	6K
	8A @ 28VDC* B300	Resistive Pilot Duty	30K 6K
3	16A/8A @ 240VAC	GP	6K
	8A @ 28VDC	Resistive	30K
	1/2 HP @ 120VAC*	Motor	6K
	1HP @ 240VAC*	Motor	6K
	48 LRA, 8 FLA @ 240VAC	Motor	30K
	B300	Pilot Duty	6K
5	8A @ 240VAC	Resistive	30K
	8A @ 28VDC	Resistive/GP	30K
	1/2 HP @ 240VAC	Motor	6K
	1/4 HP @ 120VAC	Motor	6K
	B300	Pilot Duty	6K

\* Form A only

### VDE Ratings @ 25°C:

Code	NO/NC Load	Type	Operations
1	12A @ 250VAC	Resistive	30K
	12A @ 250VAC	Resistive	100K
3	16A @ 250VAC	Resistive	10K
	16A @ 250VAC	Resistive	50K
5	8A @ 250VAC	Resistive	30K
	8A @ 250VAC	Resistive	50K

### Initial Dielectric Strength

**Between Open Contacts:** >1,000VAC (1 minute).  
**Between Poles (code 5):** >2,500VAC (1 minute).  
**Between Coil and Contacts:** >5,000VAC (1 minute).  
**Creepage/Clearance, Coil to Contact:** 10/10mm.

### Coil Data @ 20°C

**Voltage:** 24, 115, 230VAC.

**Nominal Power @ 25°C:** .75VA.

**Duty Cycle:** Continuous.

**Initial Insulation Resistance:** 10,000 megohms, min., at 20°C, 500VDC and 50% rel. humidity.

### Coil Data

Nominal Voltage VAC	DC Resistance in Ohms ±10%	Must Operate Voltage VAC	Drop-out Voltage VAC	Nominal Coil Current (mA)–50Hz.	Nominal Coil Current (mA)–60Hz.
24	350	18.0	3.6	31.6	24.3
115	8,100	86.3	17.3	6.6	5.1
230	32,500	172.5	34.5	3.3	2.3

### Max. Ambient Temp. vs. Coil Voltage

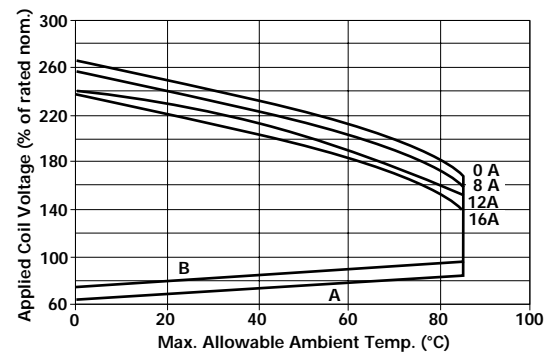

A: Coil temperature = Ambient temperature.  
 B: 110% of nominal coil voltage at rated contact load.

### Operate Data

**Must Operate Voltage:** See coil data.

**Operate Time (Excluding Bounce):** 8 ms, typ., at nom. voltage.

**Release Time (Excluding Bounce):** 11 ms, typ., at nom. voltage.

### Environmental Data

**Temperature Range:**

**Storage:** -40°C to +105°C.

**Operating:** -40°C to +70°C at rated current.

**Vibration:** 30 - 150 Hz:

at 20g with no contact opening >10µs on the N.O. contact;  
 at 5g with no contact opening >10µs on the N.C. contact.

### Mechanical Data

**Termination:** Printed circuit terminals.

**Enclosures:** RT 1, 3, 4: Flux-tight, top vented, plastic case.

RT B, D, E: Immersion cleanable, plastic case.

**Weight:** 0.42 oz. (12g) approximately.

**Ordering Information (AC Coil Model)**

Typical Part Number ▶

**RT**

**D**

**1**

**4**

**524**

**1. Basic Series:**

RT = Miniature, printed circuit board relay.

**2. Enclosure:**

1 = 1 pole 12A, Pinning 3.5mm, flux-tight (Code 1).      B = 1 pole 12A, Pinning 3.5mm, sealed (Code 1).  
 3 = 1 pole 16A, Pinning 5mm, flux-tight (Code 3).      D = 1 pole 16A, Pinning 5mm, sealed (Code 3).  
 4 = 2 pole 8A, Pinning 5mm, flux-tight (Code 5).      E = 2 pole 8A, Pinning 5mm, sealed (Code 5).

**3. Contact Arrangement:**

1 = 1 Form C (SPDT) (Requires wiring diagram codes 1 or 3.)  
 2 = 2 Form C (DPDT) (Requires wiring diagram code 5.)  
 3 = 1 Form A (SPST-NO) (Requires wiring diagram codes 1 or 3.)  
 4 = 2 Form A (DPST-NO) (Requires wiring diagram code 5.)

**4. Contact Material:**

4 = Silver-nickel 90/10.

**5. Coil Voltage:**

524 = 24VAC    730 = 230VAC  
 615 = 115VAC

**Stock Items**

RTB14524    RTD14524    RTE24524  
 RTB14615    RTD14615    RTE24615  
 RTB14730    RTD14730    RTE24730

**Outline Dimensions**

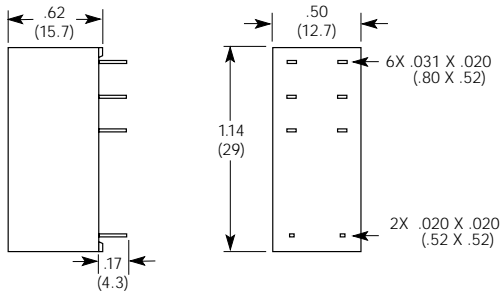

**Breaking Capacity**

**1 Pole**

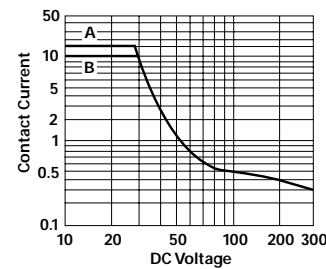

**2 Pole**

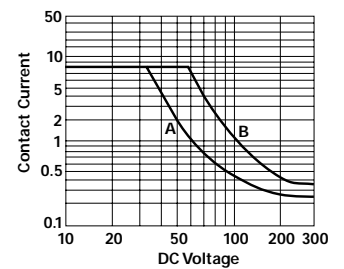

A: 16A Version.  
 B: 12A Version.

A: 1 Contact.  
 B: 2 Contacts in series.

**PC Board Layouts (Bottom View)**

**1 Pole 12A  
3.5mm**

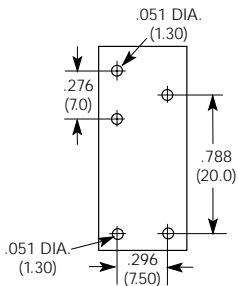

**Code 1**

**1 Pole 16A  
2 Pole 8A  
5mm**

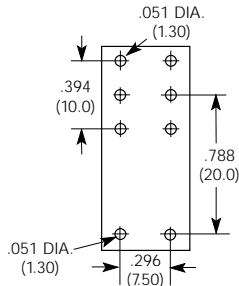

**Code 3 & 5**

**Note:** On single throw models, only necessary terminals are present.

**Contact Life for Resistive AC Load (Typical)**

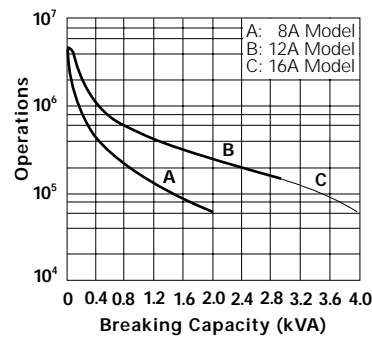

**Note:** Data from 250VAC @ 70°C.

**Wiring Diagrams (Bottom View)**

**1 Pole 12A**

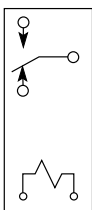

**Code 1**

**1 Pole 16A**

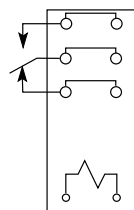

**Code 3**

**2 Pole 8A**

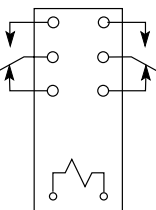

**Code 5**

**Note:** On single throw models, only necessary terminals are present.



# RT series (Latching) 16 Amp Miniature Printed Circuit Board Relay

Meets VDE 10mm Spacing, 5KV Dielectric

File E38891

File LR14385

NR 6106

## Features

- Latching relay with 1 or 2 coils.
- SPDT (16A) and DPDT (8A) contact arrangements.
- Flux tight enclosure.
- Meets VDE 10mm spacing, 5kV dielectric, coil to contacts.
- Conforms to UL 508, 1873 and 353.

## Contact Data

**Arrangements:** 1 Form C (SPDT) Wiring Diagram Code 3.  
2 Form C (DPDT) Wiring Diagram Code 5.

**Material:** Silver-nickel 90/10.

**Minimum Load:** 12V/100mA.

**Expected Mechanical Life:** 5 million operations, 1 pole.  
2 million operations, 2 pole.

Designed to meet UL/CSA/VDE ratings with relay properly vented. Remove vent nib after soldering and cleaning.

### UL/CSA ratings @ 70°C:

Code	NO/NC Load	Type	Operations
3	16A/8A @ 240VAC	GP	6K
	8A @ 28VDC	Resistive	30K
	1/2 HP @ 120VAC*	Motor	6K
	1HP @ 240VAC*	Motor	6K
	48 LRA, 8 FLA @ 240VAC B300	Motor Pilot Duty	30K 6K
5	8A @ 240VAC	Resistive	30K
	8A @ 28VDC	Resistive/GP	30K
	1/2 HP @ 240VAC	Motor	6K
	1/4 HP @ 120VAC	Motor	6K
	B300	Pilot Duty	6K

\* Form A only

### VDE Ratings @ 70°C:

Code	NO/NC Load	Type	Operations
3	16A @ 250VAC	Resistive	10K
	8A @ 250VAC	Resistive	30K
5	8A @ 250VAC	Resistive	30K
	8A @ 250VAC	Resistive	100K

## Initial Dielectric Strength

**Between Open Contacts:** >1,000VAC (1 minute).

**Between Poles (code 5):** >2,500VAC (1 minute).

**Between Coil and Contacts:** >5,000VAC (1 minute).

**Creepage/Clearance, Coil to Contact:** 10/10mm.

## Coil Data @ 20°C

**Voltage:** 5 to 24VDC\*, 1 coil.  
3 to 24VDC\*, 2 coil.

**Nominal Power @ 25°C:** 400mW, 1 coil.  
600mW, 2 coil.

**Duty Cycle:** Continuous.

**Initial Insulation Resistance:** 10,000 megohms, min., at 20°C, 500VDC and 50% rel. humidity.

\* Other coil voltages upon request.

## 1 Coil Data

Nominal Voltage VDC	DC Resistance in Ohms ±10%	Set Voltage VDC	Reset Voltage VDC	Nominal Coil Current (mA)
05	62	3.5—6.0	2.75—6.0	80.0
06	90	4.2—7.2	3.30—7.2	66.7
12	360	8.4—14.4	6.60—14.4	33.3
24	1,440	16.8—28.8	13.20—28.8	16.7

## 2 Coil Data

Nominal Voltage VDC	DC Resistance in Ohms ±10%	Set Voltage VDC	Reset Voltage VDC	Nominal Coil Current (mA)
05	42	3.5—7.5	2.75—4.5	120.0
06	55	4.2—9.0	3.30—9.0	108.0
12	240	8.4—18.0	6.60—18.0	50.0
24	886	16.8—36.0	13.20—36.0	27.0

## Operate Data @ 20°C

**Must Operate Voltage:** See coil data.

**Operate Time (Excluding Bounce):** 5 ms, typ., at nom. voltage.

**Release Time (Excluding Bounce):** 4 ms, typ., at nom. voltage.

**Max. Switching Rate:** 360 ops. at rated load.

## Environmental Data

**Temperature Range:**

**Storage:** -40°C to +105°C.

**Operating:** -40°C to +70°C at rated current.

**Vibration:** 30 - 500 Hz:

N/C opens at >3g and changes from reset to set at >5g;

**Shock:** N/C opens at >6g and changes from reset to set at >15g.;

## Mechanical Data

**Termination:** Printed circuit terminals.

**Enclosures:** RT 3, 4: Flux-tight, top vented, plastic case.

**Weight:** 0.46 oz. (13g) approximately.

Ordering Information (Latching Model)

Typical Part Number ▶

RT

3

2

4

A05

1. Basic Series:

RT = Miniature, printed circuit board relay.

2. Enclosure:

3 = 1 pole 16A, Pinning 5mm, flux-tight (Code 3).

4 = 2 pole 8A, Pinning 5mm, flux-tight (Code 5).

3. Contact Arrangement:

1 = 1 Form C (SPDT) (Requires wiring diagram code 3.)

2 = 2 Form C (DPDT) (Requires wiring diagram code 5.)

4. Contact Material:

4 = Silver-nickel 90/10.

5. Coil Voltage:

1 Coil	2 Coil	Voltage
A05	F05	= 5VDC
A06	F06	= 6VDC
A12	F12	= 12VDC
A24	F24	= 24VDC

Stock Items

Consult factory for availability.

Outline Dimensions

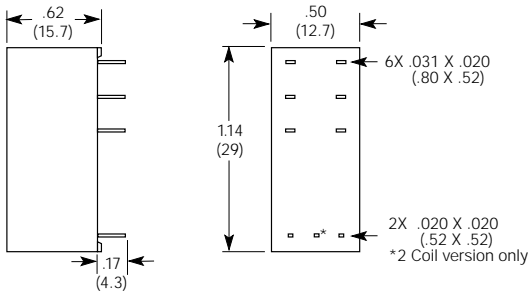

Wiring Diagrams (Bottom View)

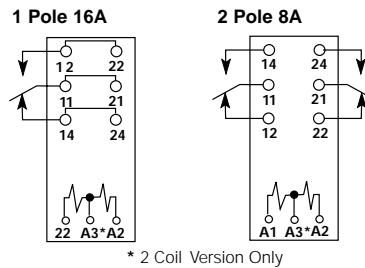

Code 3

Code 5

Coil Terminals	1 Coil		2 Coils	
	A1	A2	A1	A3 A2
Operate	+	-	+	-
Reset	-	+	-	+

Contact position not defined at delivery.

PC Board Layout (Bottom View)

1 Pole 16A  
2 Pole 8A  
5mm

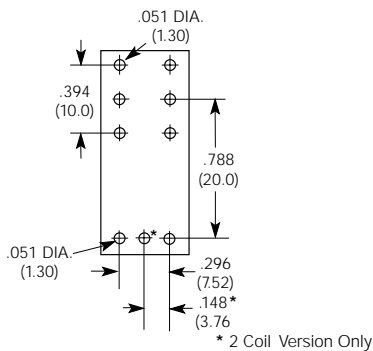

Code 3 & 5

Breaking Capacity

1 Pole

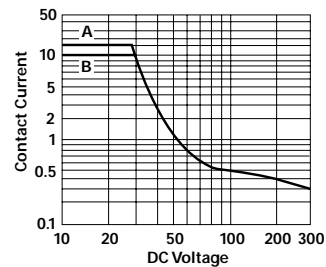

A: 16A Version.  
B: 12A Version.

2 Pole

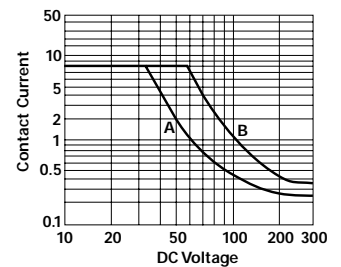

A: 1 Contact.  
B: 2 Contacts in series.

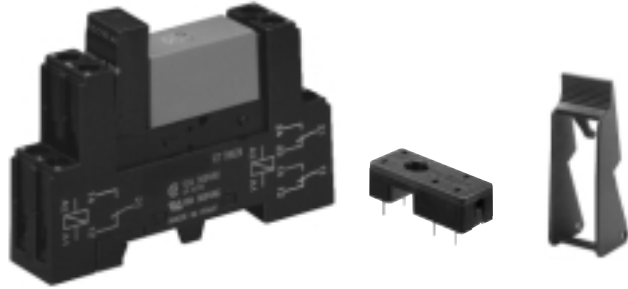

RT78625 with RPMU0730

RP78601

RT16016

# RT series Sockets and Accessories

- File E135149
- File LR14385
- NR 5318

## Sockets for RT Series Relays

**RT78624<sup>1</sup>**  
10A, 300VAC  
3.5mm Pinning

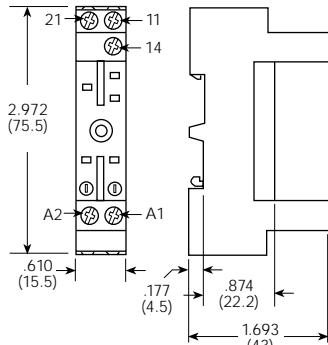

Hold-Down Spring RT16016

**RT78625<sup>1,2</sup>**  
1 Pole 10A, 250VAC  
2 Pole 2x 10A, 250VAC  
5mm Pinning

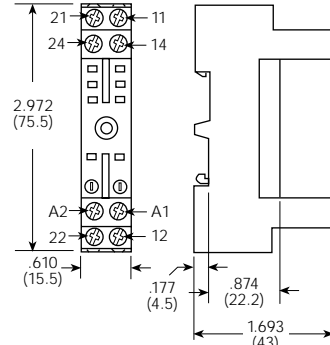

Hold-Down Spring RT16016

**RT78626<sup>1,2</sup>**  
1 Pole 12A, 300VAC  
2 Pole 2x 12A, 300VAC  
5mm Pinning

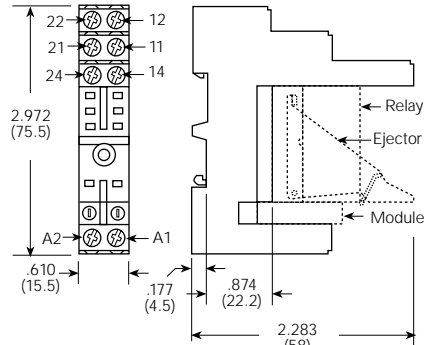

Ejector/Hold-Down Spring RT16016<sup>3</sup>

**RP78601<sup>1</sup>**  
10A, 250VAC  
3.5mm Pinning

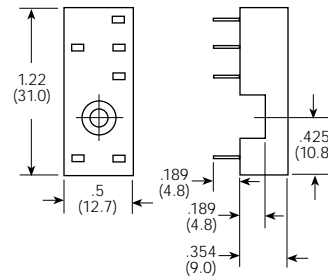

Hold-Down Spring RP16041

PC Board Layout  
(Bottom View)

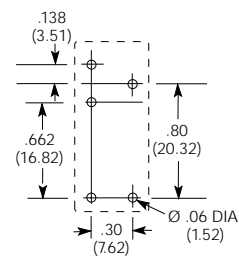

**RP78602<sup>1</sup>**  
1 Pole 10A, 250VAC  
2 Pole 2x 10A, 250VAC  
5mm Pinning

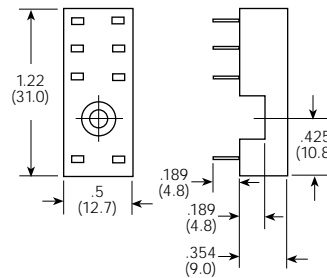

Hold-Down Spring RP16041

PC Board Layout  
(Bottom View)

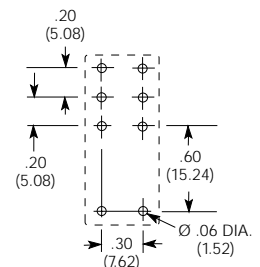

## Socket and Accessory Selection Table

Stock items are boldfaced.

Socket	Socket Termination	Hold-Down Spring
<b>RT78624<sup>1,2</sup></b>	DIN Screw Terminal Socket	<b>RT16016</b>
<b>RT78625<sup>1,2</sup></b>	DIN Screw Terminal Socket	<b>RT16016</b>
RT78626 <sup>1</sup>	DIN Screw Terminal Socket	<b>RT16016</b>
RP78601 <sup>1</sup>	PCB Terminal Socket	RY16041
RP78602 <sup>1</sup>	PCB Terminal Socket	RY16041
RPM00A0	Protection Diode Module 1N4007 <sup>4</sup>	-
RPMU0548	RC Network Module 24-48VAC	-
RPMU0730	RC Network Module 110-230VAC	-
RPML0024	LED Module 12-24VDC <sup>4</sup>	-
RPML0524	LED Module 12-48VAC/VDC	-
RPML0110	LED Module 110VDC <sup>4</sup>	-
RPML0730	LED Module 110-230VAC	-

**\* Note**

1. Not suitable for bistable relay with two coils.
2. For a 16A 1 pole relay the following jumpers have to be connected; 11 to 21, 12 to 22 and 14 to 24.
3. Insertion of the relay.  
First the ejector (and eventually the module) has to be mounted onto the socket. Then the relay has to be set in the correct position and pressed into the socket until the ejector snaps over the top of the relay.
4. Standard polarity: A1:+, A2:-