

FILM-TECH

THE INFORMATION CONTAINED IN THIS ADOBE ACROBAT PDF FILE IS PROVIDED AT YOUR OWN RISK AND GOOD JUDGMENT.

THESE MANUALS ARE DESIGNED TO FACILITATE THE EXCHANGE OF INFORMATION RELATED TO CINEMA PROJECTION AND FILM HANDLING, WITH NO WARRANTIES NOR OBLIGATIONS FROM THE AUTHORS, FOR QUALIFIED FIELD SERVICE ENGINEERS.

IF YOU ARE NOT A QUALIFIED TECHNICIAN, PLEASE MAKE NO ADJUSTMENTS TO ANYTHING YOU MAY READ ABOUT IN THESE ADOBE MANUAL DOWNLOADS.

WWW.FILM-TECH.COM

CONSTRUCTION PLANS

MACROMOD COMPRESSOR

(MMC)

The PANAXIS MACROMOD COMPRESSOR is a self contained electronic audio device for the compression of the dynamic range of music or voice. A built-in compression ratio of 2 to 1 sufficiently boosts modulation levels (loudness) but without destroying the dynamic range of the music or voice so that normalness is maintained. A peak limiter is included to keep modulation of a transmitter at or slightly below 100%. An LED indicator shows when modulation peaks are excessive.

The MMC consists of two identical compressor circuits. Each may be operated independantly of each other or together as a stereo unit. A DIP switch is used to connect (strap) the two sections together so each stereo channel is controlled by the peak modulation of either channel. This maintains proper channel separation and integrity. In the MONO mode each section works indepent of the other. In this way two separate program channels may be used. Another possibility is to feed the output of one section into the input of the other section. In this case a 4 to 1 compression ratio can be obtained. This will be louder still with some loss of normalness in dynamic range of music being noticable.

SPECIFICATIONS

Audio Response	20 - 20 KHz
Distortion	.5% or less below 100%
Noise	70 dB below max out
Audio input level (max)	+10 dBm (7 volts p-p)
Audio output level (max)	+20 dBm (20 volts p-p)
Audio output level (normal operation)	+4 dBm (2.7 volts p-p)
Input impedance	10 K or 600 ohms *
Output impedance	10K or 600 ohms *
	*(see text)
Operating power	117 vac (less than 1 watt)
Physical size in cabinet	5" W x 5.4" L x 2.7" H
Weight	About 2 pounds
Circuitry	all solid state

Typical assembly time (if all parts are on hand) 4 hours.

COPYRIGHT by PANAXIS PRODUCTIONS, Box 130, Paradise, CA 95969

THEORY OF OPERATION

It will be helpful to look at Fig. 1 while reading this section.

One section of an LM 349 operational amplifier (op amp) is used as a gain controlled amplifier. This stage has a dc stabilization feedback via R5 and R4 with C3 bypassing all audio signals in the feedback loop. Ac (audio) feedback is via R13 and C11 through the "gain cell" section of an NE 571 compander chip. The audio feedback enters the gain cell through pin 3 and exits by pin 5 which is connected back to the input (pin 2) of the LM 349.

The output of the op amp is also fed through C13 to the rectifier section of the compander chip (pin 2). The signal is rectified (changed to dc) and the resultant dc potential is stored in C15. The output of the rectifier is a varying dc voltage proportional to the amplitude of the audio signal. This output is internally connected to the gain cell section of the compander chip. When ever the audio signal amplitude increases the rectifier output increases and the amount of feedback through the gain cell increases. In other words, increases in audio amplitude are compressed at the output of the op amp.

The relationship between input and output signals is shown in Fig. 2. Looking at the normalized curve (B) which shows 0 dB input yields a 0 dB output. Checking each point down the curve toward -70 dB output it can be seen that the output increases only about 5 dB for each 10 dB change of the input. The curve is not a perfectly straight line but curves slightly as input amplitude increases. In other words, low level signals are not as compressed as are the large amplitude ones. A change of -70 dB to -60 dB (10 dB input change) yields a -46 dB to -38 dB (8 dB change) at the output. However an input from -10 to 0 dB (10 dB change) yields only a 5 dB change at the output from -5 dB to 0 dB. This helps preserve the dynamic range of the lower level signals.

Resistor R16 provides a slight positive bias for the rectifier section of the NE 571. This helps in reducing background noise levels. R14, R15, C14 and R12, C5, are bias and compensating components to establish operating points for the IC's.

The output of the op amp (pin 1) is fed to diodes D1, D2, D3 and the 2N3904 transistor. C4 blocks any dc voltage that may be present at the op amp's output. R6 is used to "lose" signal. The output voltage at pin 1 is seen in most part across R7 (output gain control). When the output exceeds about 1.4 volts peak in the negative direction diodes D2 and D3 conduct. Any voltage level above that is "lost" in R6. When the output exceeds about 1.4 volts peak in the positive direction diode D1 and the 2N3904 transistor conduct again limiting the peak voltage seen by R7. When the 2N3904 conducts it causes D4, an LED indicator to glow. This is your peak limiter circuit. No more than 2.8 volts peak to peak will be seen across R7. The clipping action (limiting action) of the diodes is buffered by R6. Instead of peaks being cut off flat (loaded with third harmonic distortion) they are instead rounded off.

The second section of the LM 349 is used as an output amplifier. R7 allows you to set the amplitude of that output. Again, looking at Fig. 2 it can be seen that the output can be set for a maximum of +15 dB before limiting occurs. It may be set as in curve B wherein the maximum output would be 0 dB. If a lower limiting level is desired (shown in dashed instead of dotted lines) you simply place a wire jumper across D1 or D2. This may be done during assembly if you like by just leaving out D1 and D2 and replacing either with a piece of wire.

R10 at the output is used to protect the output op amp from damage which might result if the output were accidentally shorted. R11 is used for either of two purposes. One, it may be used as a termination resistor by connecting its free end to circuit ground. This may be done if you desire an internal termination of 600 ohms. The value of R11 would then be a 620 resistor. Two, it may be used as the compensating series resistor required by some VU meters should you desire to hook up a meter to your compressor. The value of R11 is determined by what compensation is needed for your particular meter.

Back to the input circuit. R1 is your input gain control. Its value is determined by what input impedance you desire. It would be a 10 K potentiometer if you desire a 10 K ohm input. A 500 ohm potentiometer would suffice to give you an approximate 600 ohm input. At maximum gain a 0 dB input signal would peak limit the output at a + 15 dB. At lower gain settings larger input amplitudes may be used. The Output gain control of course will be the final determination of the output level.

S1A when switched in connects C2 across R3. This provides a 75 microsecond pre-emphasis when the unit is used with some FM transmitters. It is not needed for AM transmitter modulation.

When the unit is used in stereo operation the rectifier section of the NE 571 for each channel must be connected together. This is done by closing switch S1 both B and C sections. If it is known before assembly of the unit what its use will be then the DIP switch could be omitted and wire jumpers permanently soldered in the desired holes of the pc board.

Only one channel has been shown for clarity on the schematic. The other channel is identical (including part numbers) except for the pin numbers on the IC chips. Corresponding pin numbers are:

NE 571		LM 349	
Section 1	Section 2	Section 1	Section 2
5	12	2	13
8	9	3	12
3	14	1	14
4	4	6	9
13	13	5	10
2	15	7	8
1	16	4	4
		11	11

The power supply utilizes a 24 volt center tapped transformer and diodes to provide a full-wave rectified dc for the regulators. Capacitors C16 and C17 filter the resultant ripple from the rectifiers. C18 and C19 remove fast transient spikes that may occur from time to time on the power line. The 78L12 provides a well regulated 12 volts positive dc output of up to 100 milli-amperes. The 79L12 does the same except its output is a minus 12 volts. D6 is an LED which glows when power is on.

Capacitors C6, C7, C8, C9, and C12 assure that circuit induced noises are not transferred to other circuits by way of the dc power connections.

PARTS LIST (Numbers in () indicates number of that part required)

(all resistors 1/4 watt)			Semiconductors:		
Part #	Description	Color Code			
(2) R1	1K pot.	3/8" square	(1)	LM 349	Quad Op Amp
(4) R2,R13	4.7 K ohm	YL/VI/RD	(1)	NE 571	Compander
(2) R3	24K ohm	RD/YL/OR	(2)	2N3904	Transistor (npn)
(4) R4,5	47K ohm	YL/VI/OR	(6)	1N4148	Diode(D1,2,3)
(4) R6,R12	1K ohm	BR/BK/RD	(1)	78L12	+ 12 v Regulator
(2) R7	20K pot.	3/8" square	(1)	79L12	-12 v Regulator
(2) R8	22K ohm	RD/RD/OR	(4)	1N4002	D7,8,9,10
(2) R9	120K ohm	BR/RD/YL	(3)	LED (T1 3/4)	D4,5,6
(2) R10	100 ohm	BR/BK/BR			
(2) R11	see text				
(4) R14,15	68K ohm	BL/GY/OR			
(2) R16	2 Megohm	RD/BK/GN			
(3) R17,18,19	470 ohm	YL/VI/BR			
Capacitors: 12 or 16 volt miniature					
(14) C1,3,4,5	Electrolytic=()		(1)	1/2 amp fuse	
11,13,14	4.7 uF (axial type)		(2)	mini-pc fuse clips	
(2) C6,9	10 uF (axial type)		(1)	(S2) push button on-off switch	
(2) C2	.003 uF ceramic		(1)	(S1) 4 pole DIP Switch	
(2) C10	47 uF (axial type)		(1)	Transformer 24Vc.t. 120 ma	
(2) C15	1 uF (axial type)		(4)	RCA jacks, chassis mount	
(2) C16,17	470 uF (radial type)		(3)	T 1 3/4 LED mounting clips	
(5) C7,8,12,18,19	.1 uF ceramic		(1)	Line cord strain relief	
			(1)	Line cord	
			(1)	Cabinet: 5" x 5.4" x 2.7"	
			(1)	PC board	
			(2)	4 - 40 x 1/4" screws	
			(2)	4-40 nuts	
			(8)	#4 x 1/4" sheet metal screw	
			(4)	1/2" long plastic standoffs	
				Wire: #24 insulated, 1 foot of the	
				following colors: Green, Blue, Red	
				18" of miniature audio coax cable	

PARTS SOURCES

MOUSER ELECTRONICS
11433 Woodside Ave.
Santee, CA 92071
619-449-2222 (free catalog)

JAMECO ELECTRONICS
1355 Shoreway Rd
Belmont, CA 94002
415-592-8097

(A complete kit is available from PANAXIS - 916-534-0417)

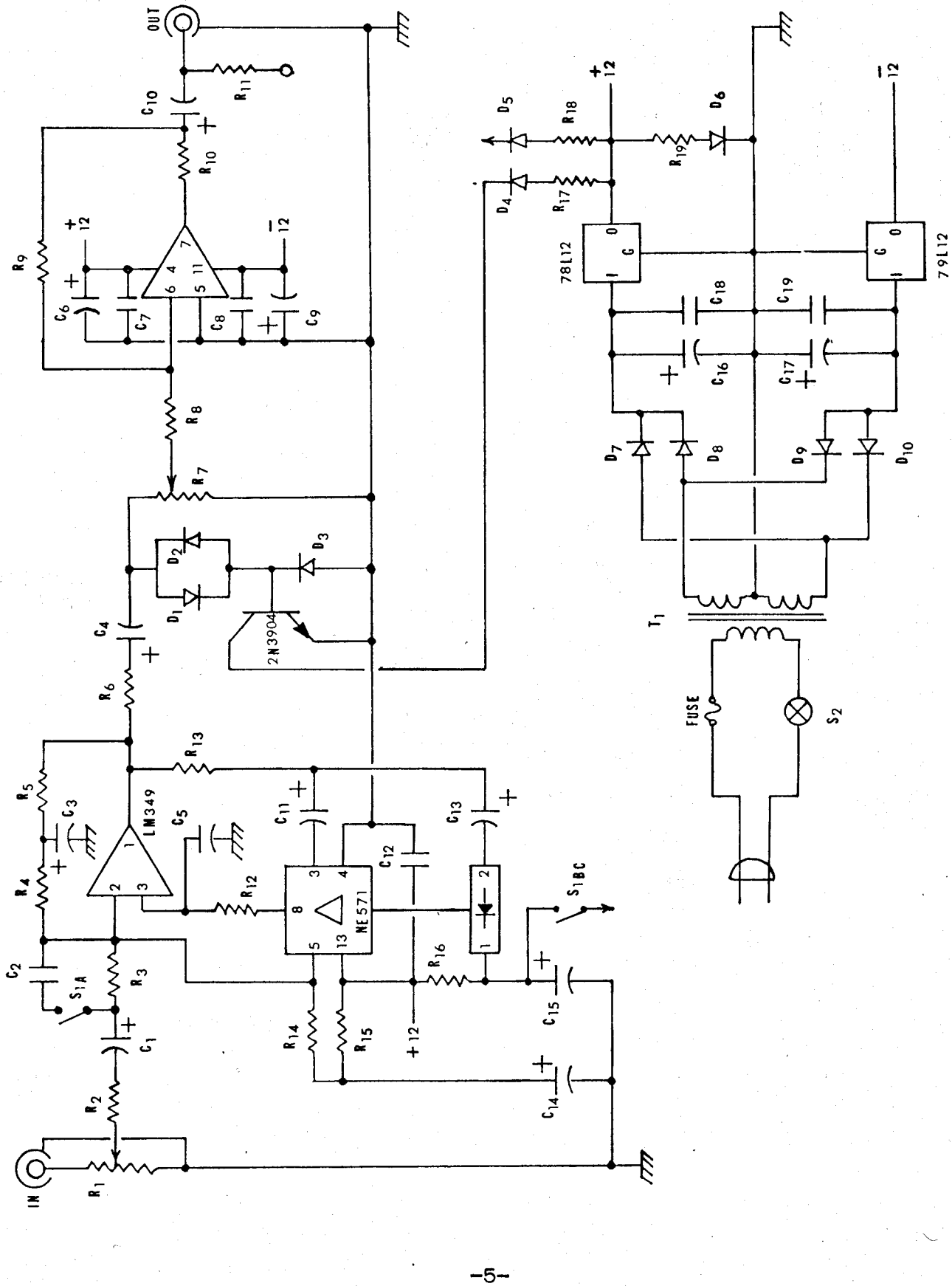
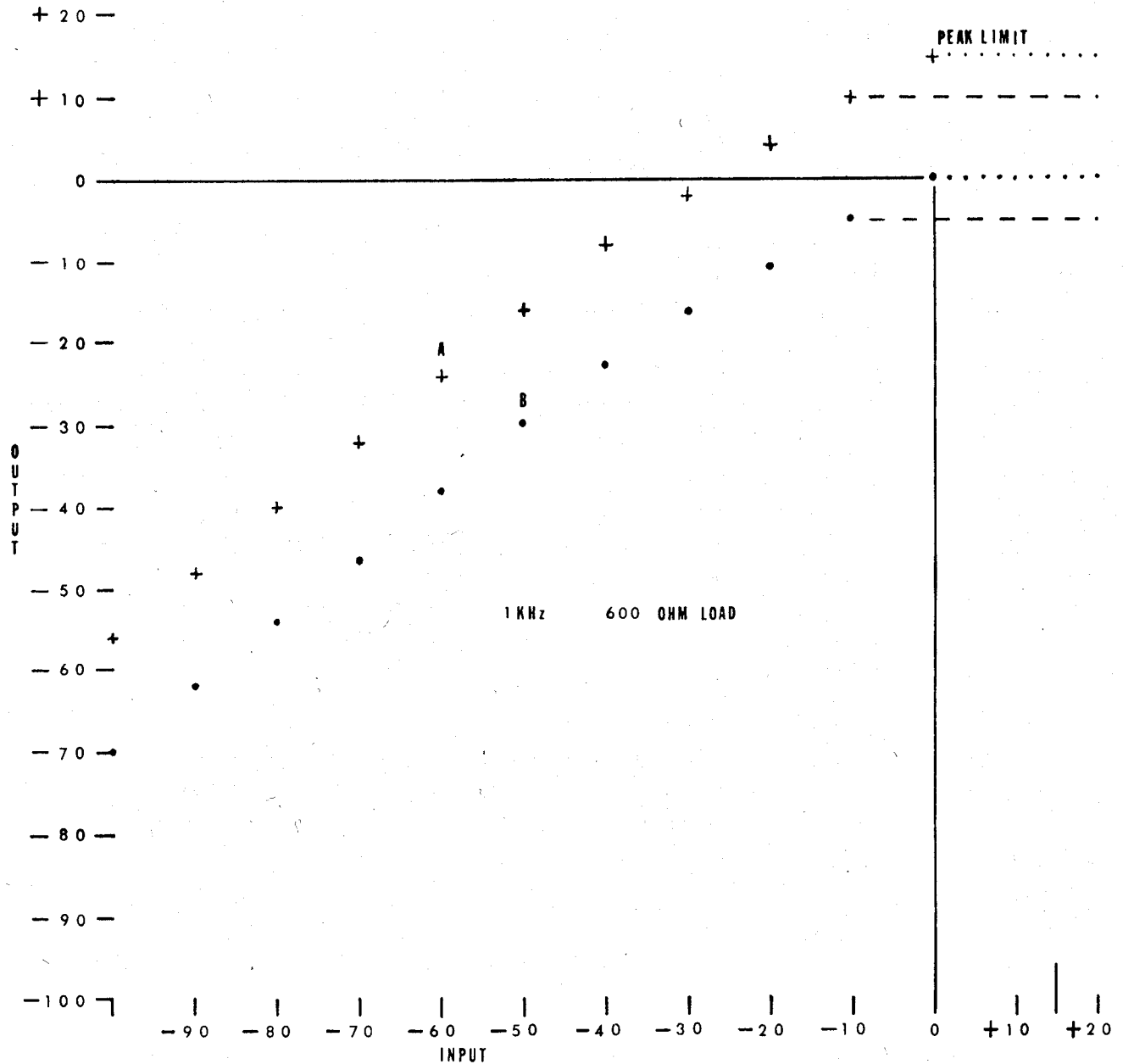

Fig. 1 Schematic Diagram

Compression Characteristics: (Fig. 2)

The following curves were plotted with a 600 ohm input and 600 ohm output at a test frequency of 1 kHz. Input gain control (R1) was set so that a 0 dB input would just begin operating the peak limiter. The output gain control (R7) was first set to give a 0 dB output with a 0 dB input - resulting in plot B. Plot A was a result of setting control R7 for a maximum of + 15 dB output with a 0 dB input. Actually all measurements are in dBm based on 1 milliwatt into 600 ohms at 0 dBm.



ASSEMBLY INSTRUCTIONS

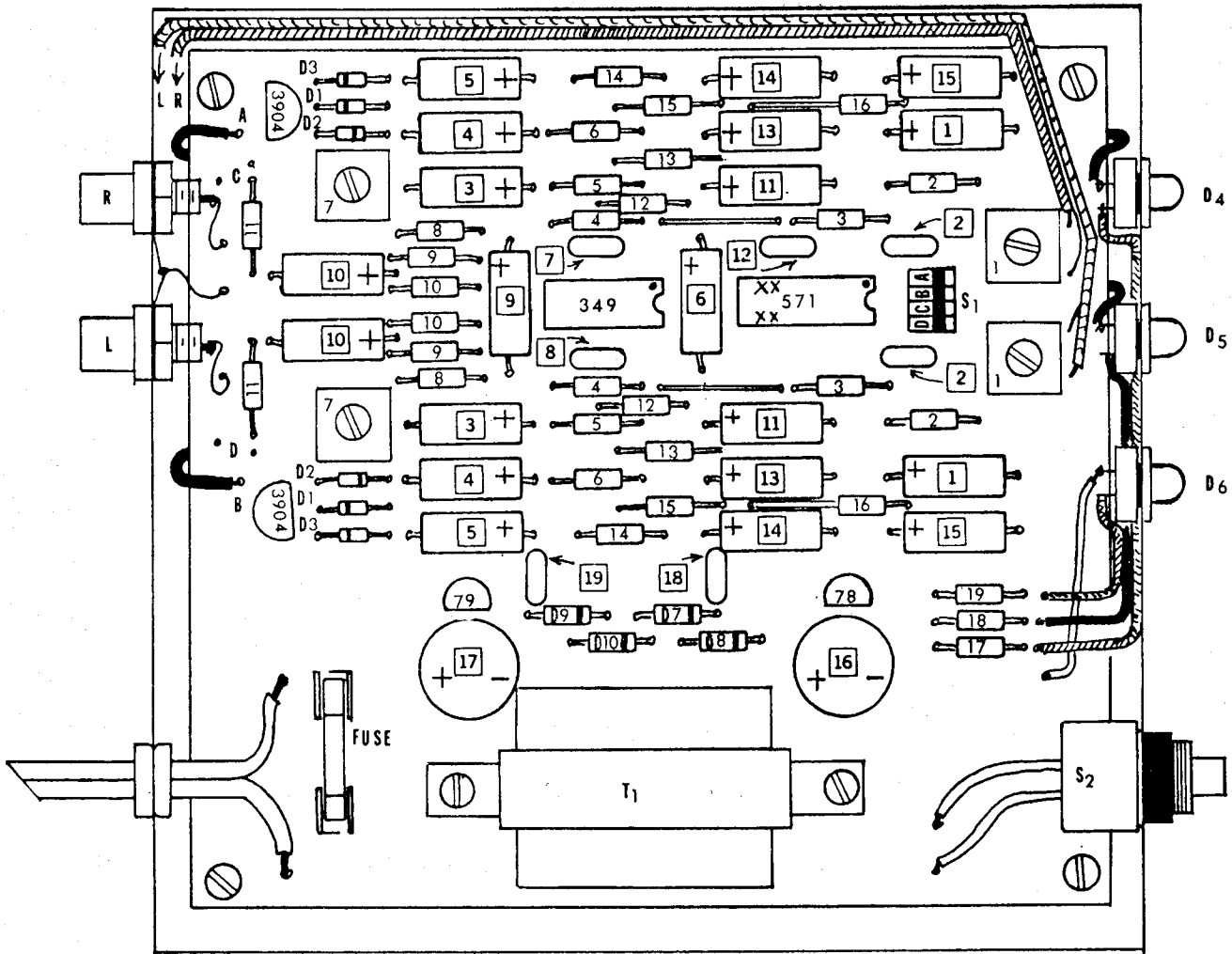

Fig. 3 Assembly Drawing

Look over Fig. 3 thoroughly before beginning assembly. The PC board parts will be installed first. Then the cabinet is prepared. Then the circuit board is installed in the cabinet chassis pan. The unit is then tested before actual operation is attempted.

There are two identical circuits on the board. The two sets of resistors and capacitors, diodes, etc., which are the same for each circuit have the same number assigned to them. In other words, there are two R1's, two C2's, etc.

Capacitors are numbered with a square around the number. Resistors simply show the number. Diodes have a band on one end and have a "D" in front of the number. The 2N3904 transistors are shown as simply "3904". The voltage regulators are shown as "78" for the 78L12 and "79" for the 79L12.

Install all fixed value resistors:

Refer to parts list for value, number, and color code of each resistor. Install each in the pc board and bend the leads flat against the copper side of the board. When all resistors are in place check each to assure its the right one. With wire cutters (diagonal pliers) cut off excess lead length so that just a bit of a hook rests on each copper pad. Solder each wire to its pad.

Install all diodes:

Refer to parts list for number of diode and part number. Install just like the resistors but be sure the banded end of each faces the directions shown in the assembly drawing. Cut and solder leads just like you did with the resistors. Check to be sure banded ends are correct.

Install all capacitors except C16 and C17:

Refer to parts list for number and value. Capacitors should be kept close to the board. Bend, cut and solder leads as above after checking for correctness of polarity markings (+). Damage to the unit could result from any electrolytic cap installed with its polarity marking in the wrong direction.

Installation of LM 349 and NE 571:

Look at the pc board where the NE 571 goes. You'll see that no holes are present where pins 6,7,10, and 11 should go. These pins of the NE 571 are not used and should be removed from the IC. Little "x" s are shown in the drawing where the pins are located. Just snip off the ends of those pins. Install the LM 349 and the NE 571 with the notch and/or the dot as shown in the drawing. Generally the IC pins are a little too wide to just slip into the holes. If so just press the pins of each row toward each other a small amount. Hold the IC firmly in place and solder the pins to the pads. If desired you can fold over a pin at opposite corners of each pine row to hold the IC in place while soldering.

Installation of variable resistors (potentiometers) and DIP switch:

Install the R1 and R7 potentiometers. Hold firmly in place (or bend over lead on copper side) and solder. Cut off any excess pin length. Install the DIP switch (S1) as shown. Hold firmly to board and solder all pins.

Installation of transistors and voltage regulators:

The voltage regulators and transistors have a flat side and three leads. The flat side must face as shown in the drawing. They will not fit closer than about 3/16" above the board - this is just right. Solder each lead and cut off excess leadlength.

Installation of remaining power supply components:

Press the two fuse clips into the board. Be sure "open" end of each clip face each other (the closed ends face out). Solder in place.

Install C16 and C17. Be sure the polarity markings are as shown in the drawing. Each should seat firmly against the board. Solder each lead and cut off excess.

Mount transformer T1 with two 4-40 x 1/4" screws and nuts. Carefully guide the wires of the primary (2 wires) and the secondary (3 wires) into the proper holes while mounting. Solder wires. There should not be much excess to cut off.

Insert the leads of S2 into the proper holes in the board and solder. The leads of S2 may be left long if desired. The soldered ends of the leads however should have any excess length cut off.

Installation of wires and jumpers:

Install a blue wire about 7" long at point "A". Solder in place. This will go to D4 later on. Install a green wire about 7" long at point "B". Solder in place. This will go to D5 later on.

Install a red wire about 5" long in the hole at the end of R17. Install a red wire about 3" long in the hole at the end of R18. Install a red wire about 2" long in the hole at the end of R19. Solder each in place.

Install about 9" of miniature audio coax at each of the points provided by each of the R1 input gain potentiometers. The center conductor of each coax go in the holes farthest from each other. The shield leads go in the holes closest to each other. These will connect to the LEFT and RIGHT input jacks later on. Solder in place.

To hook up a VU meter for each channel install a pair of wires at point "C" and another pair at point "D". Make wires as long as needed to reach your meters. Solder in place. "C" wires are RIGHT channel. "D" wires are LEFT channel.

Install a 2" bare wire in each of the three holes, shown in the drawing, between the R11's and the output jacks. Solder. These will later connect to the jacks.

Install a bare jumper wire (or insulated if you prefer) between R3 and R4 of each section in the holes provided. Solder in place.

Preparing board for installation in cabinet:

Clean circuit side thoroughly with alcohol and a stiff bristle brush to remove all solder flux. Inspect each solder connection for proper connection between wire and pads. Look for possible splashes and solder "bridges" that might cause a short circuit between traces. Correct any errors.

Install a plastic spacer at each corner with a sheet metal screw. Set the board aside while you prepare the cabinet.

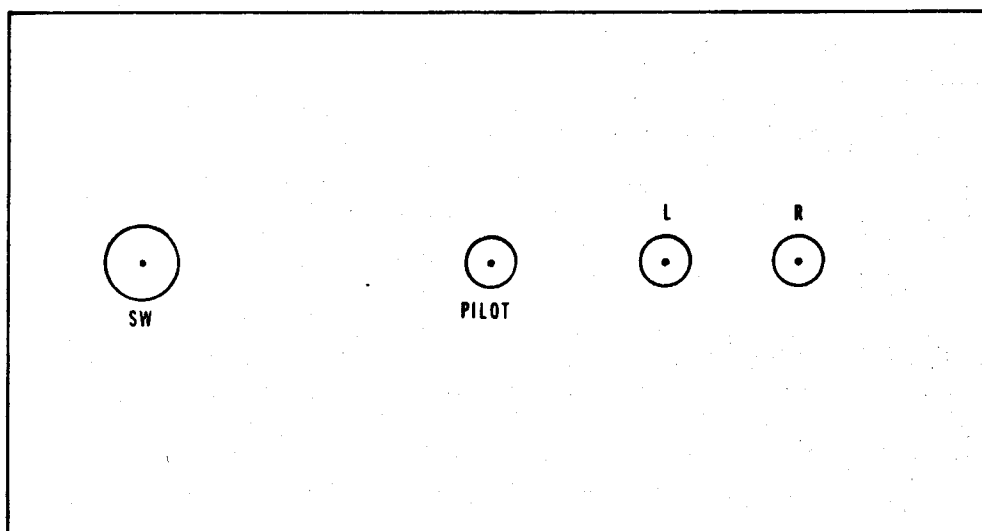

Fig. 4 Front Panel (Full Size)

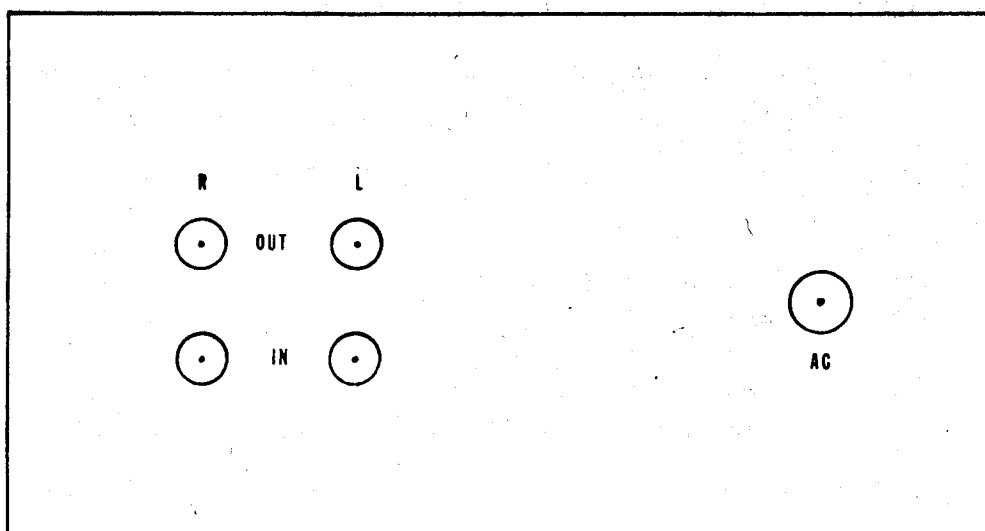

Fig. 5 Rear Panel (Full Size)

PREPARATION OF THE CABINET

Make a Xerox (photocopy) of Fig. 3 (or make a tracing on a piece of paper) of the edge of the pc board and the four mounting hole centers. Use this as a template fitted into the inside bottom of the cabinet chassis pan. Mark (center punch) the hole locations on the chassis pan. Drill a 4-40 clearance hole at each location. Remove rough edges around the holes.

Use Fig. 4 as a template for the front panel. Center punch each location. The switch hole is 3/8", the others are 1/4". If you do not have a 3/8" drill you can use a 1/4" drill and enlarge the hole with a reamer. If you do not have a reamer you can CAREFULLY cut the hole larger with an Xacto knife - DON'T SLIP! Deburr holes with a larger size drill or an Xacto knife.

Use Fig. 5 as a template for the rear panel. Center punch each location. The strain relief (for the line cord) hole is slightly smaller than 3/8". All other holes are 1/4". To enlarge the strain relief hole use a reamer or an Xacto knife as above. Deburr holes with an Xacto knife...carefully.

Install the three LED clips in the front panel.

Install the four RCA jacks in the rear panel. The solder lug for each jack must be on the inside of the chassis pan. Tighten nuts snug but do not overtighten as this could break the jack.

Install the line cord in the strain relief then the strain relief in the hole in the rear panel. Leave about 3" of line cord sticking into the chassis pan for later connection to the circuit board. See Fig. 6 below for strain relief installation.

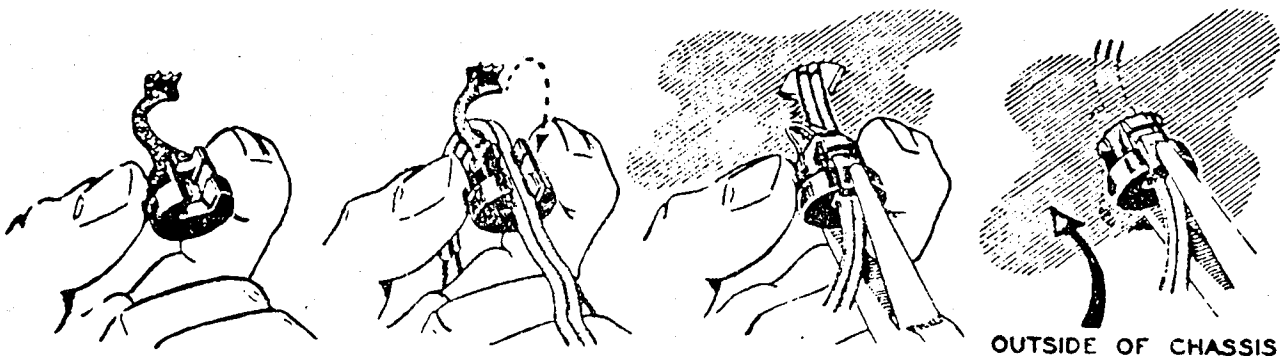

Fig. 6 Strain Relief Installation

Install rubber feet on cabinet.

INSTALLATION OF CIRCUIT BOARD

See Fig. 3..... Install the line cord wires in the appropriate holes in the circuit board. Solder. Cut off any excess lead length.

Place the Blue and Green wires under the circuit board as shown in the drawing.

Position the circuit board in the chassis pan. Fasten in place with four #4 sheet metal screws screwed into the plastic standoffs (spacers). This should hold the circuit board about 1/2" above the bottom of the chassis pan.

Install switch S2 in the front panel and tighten nut snug (just a little more than finger tight).

Press in the 1/2 amp fuse into the fuse clips.

YOU ARE NOW READY TO TEST THE POWER SUPPLY. Skip to "Test and Operation". If power supply checks out ok return to here to complete circuit board installation.

Bring the miniature audio coax cable around the side of the board to the rear panel. The LEFT and RIGHT input jacks are directly below the output jacks so they are not shown on the drawing. Connect the center conductor of the LEFT coax to the center pin of the LEFT input jack - the shield to the ground lug. Solder. Now do the same with the RIGHT coax and RIGHT input jack. Solder.

The LEFT and RIGHT and GROUND wires are connected as shown in the drawing to the upper pair of jacks. These are the output jacks. Solder leads in place.

Press the three LED's into the three LED clips on the front panel. Connect the Red wire from R17 to the long pin on LED D4. Solder. Connect the Red lead from R18 to the long pin on LED D5. Solder. Connect the Red wire from R19 to the long pin on LED D6. Solder.

Connect the Blue wire to the short pin of D4 and solder. Connect the Green wire to the short pin of D5 and solder. Connect the black wire to the short pin of D6 and solder.

This completes the installation of the circuit board. You are now ready for operational testing.

TEST AND OPERATION

Power supply testing: Have a volt meter set to a range that will measure 12 volts handy before applying power to unit. Connect the ground lead of the voltmeter to circuit ground (center bare wire near R11's). Connect the other lead of your volt meter to the + end of C6. Apply power momentarily - meter should read +12 volts. Switch off power. . . . connect ground lead of voltmeter to - end of C9, connect the other lead to the + side of C9. Apply power momentarily - meter should read 12 volts (this checks your -12 volt supply).

If both readings are good you may go on with the rest of the assembly. If not you must recheck your wiring and soldering to find the problem. Do not proceed until you have corrected the problem.

Operational Testing: Switch on power. LED D6 should glow showing that the unit is ready for action. Switch off. . . D6 should stop glowing (slowly maybe).

Connect an audio source to both the left and right input jacks. The audio should have a level of up to 0 dB or a little better on peaks. Do not use a stereo signal at this point - both inputs should see the same audio frequency and audio level.

Adjust each R1 pot. The R1 pot for the RIGHT channel is adjusted so the LED D4 begins to glow (this shows the limiter section is operating). Do the same with the R1 pot for the LEFT channel. By the way. . . the DIP switch should have all sections OFF during this test.

Operational adjustments: You can now connect the unit into your audio circuits. Your audio source should be capable of up to 3 volts rms on peaks. A good input level would be 1 volt rms (about +4 dbm). Adjust both channels with the same frequency and input level. Adjust the R1 pots so their respective LED's begin to glow. Any signal level over this amount will be limited (clipped).

The output gain pots (R7's) adjust the level going to your recording equipment or transmitter or whatever. Maximum undistorted output is about +15 dBm. To allow yourself some "head room" for peak excursions you should adjust your output for about 0 dBm. If the unit is used for stereo then you should take care to adjust for equal outputs from each channel. A VU meter (or the ac voltmeter section of a multimeter) should be used to assure proper adjustment.

If 0 dBm is too high of a level for the input of your transmitter, recorder, or whatever, you may want to install an attenuating pad between the MMC and the other unit. It is usually best to operate with a large signal output and reduce it just before going into the input of other equipment. This improves the signal - to-noise ratio. This is especially true if the units are to be some distance apart and the signal must pass through a long cable. The attenuating pad would be placed at the input of the transmitter or recorder. A 20 dB pad for example drops the signal voltage to 1/10th of its original value. A simple "L" pad would consist of a 5600 ohm resistor in series with a 620 ohm resistor.

Fig. 7 shows a typical "L" pad hookup.

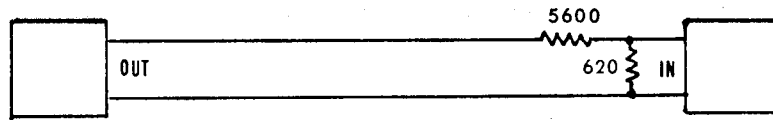

Fig. 7 "L" pad hookup

If the MMC is used for stereo signal processing the two circuit's gain rectifiers must be connected together. This is done by closing the two center DIP switches. For MONO operation these switches must be open.

In some cases it is beneficial to employ a pre-emphasis circuit ahead of the audio before compression. If this is desired (used only when modulating an FM transmitter) then both outer switch sections of the DIP switch should be closed. For all other operation they must be open.

Install the cover of your unit and you're all done. Congratulations!

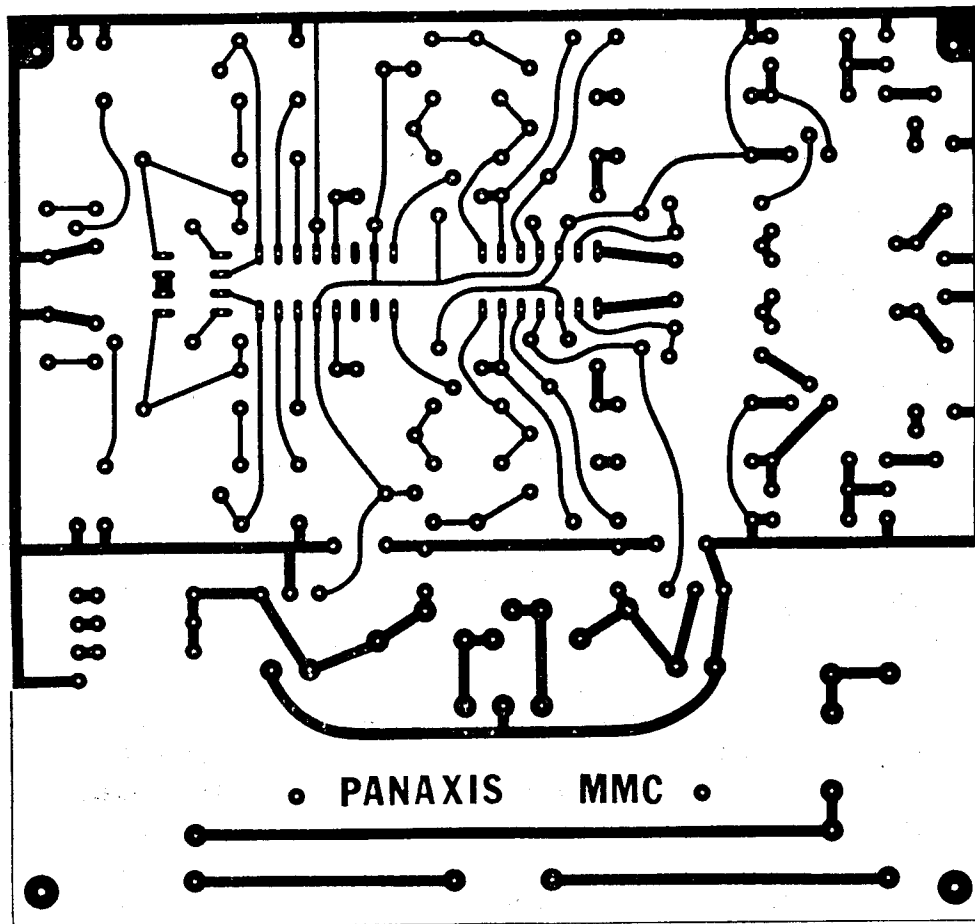

Fig. 8 Printed Circuit Artwork (full size)