

OPTION I/O
XFMR BAL.

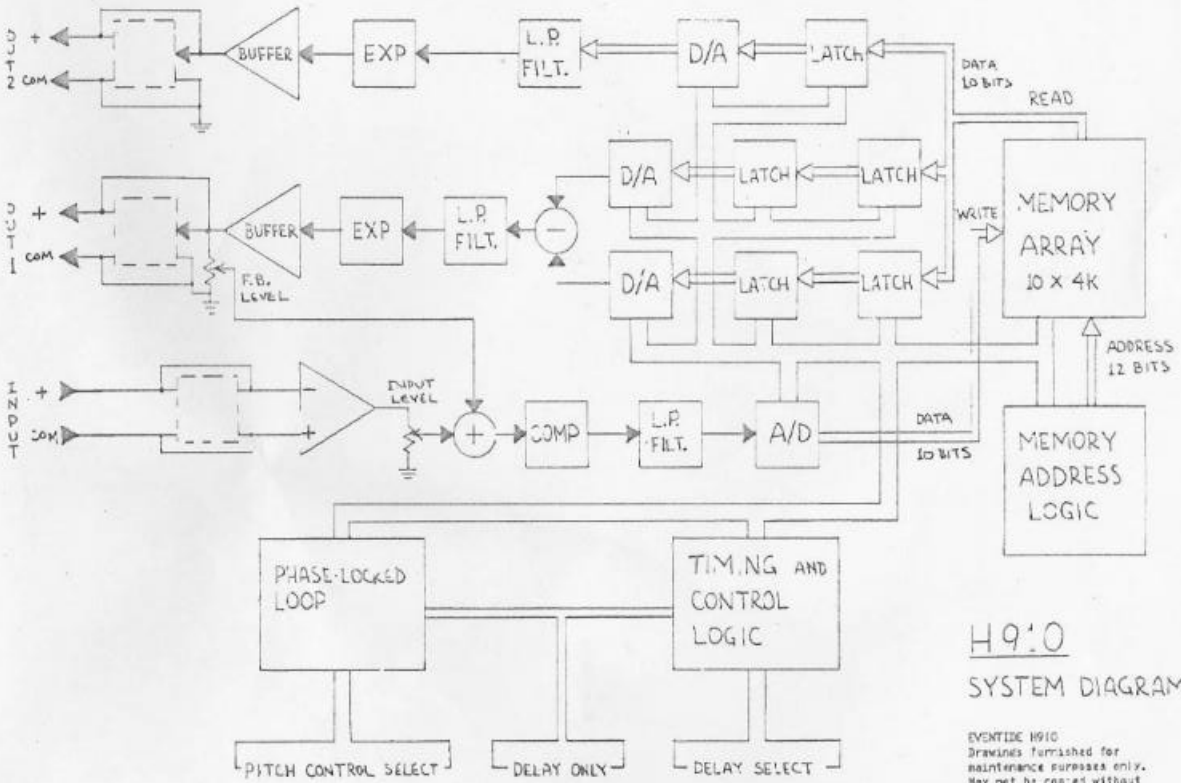

H910
SYSTEM DIAGRAM

EVENTIDE H910
Drawings furnished for
maintenance purposes only.
May not be copied without
written permission.
Copyright 1976 REV

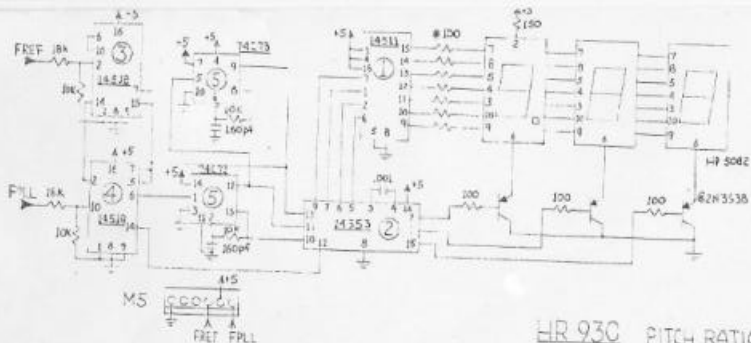
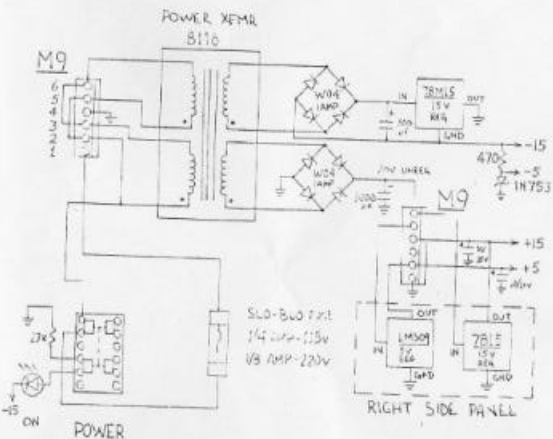

FIGURE 10
 Drawings furnished for
 Maintenance Purposes Only
 May not be copied without
 written permission.
 Copyright 1970

HR 930 PITCH RATIO READOUT



FOR 220V OPERATION

- M9 1) REMOVE JUMPER 6-3
 2) REMOVE JUMPER 5-2
 3) INSTALL JUMPER 5-3

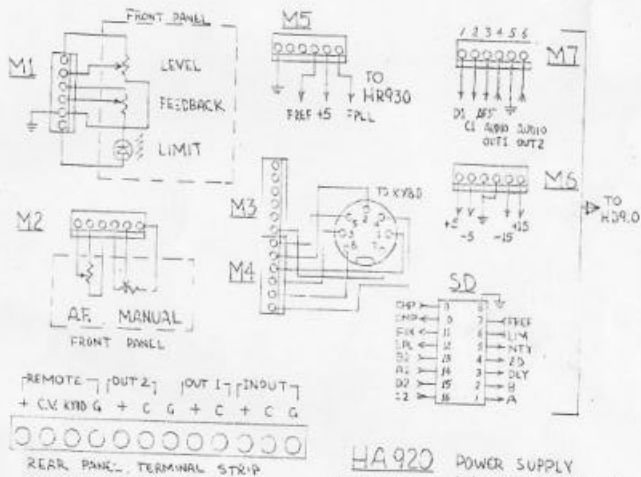

HA 920 POWER SUPPLY AND INTERCONNECTIONS

PAGE 1 OF 3
 (REV C)

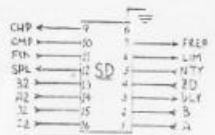
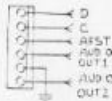
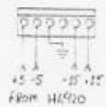
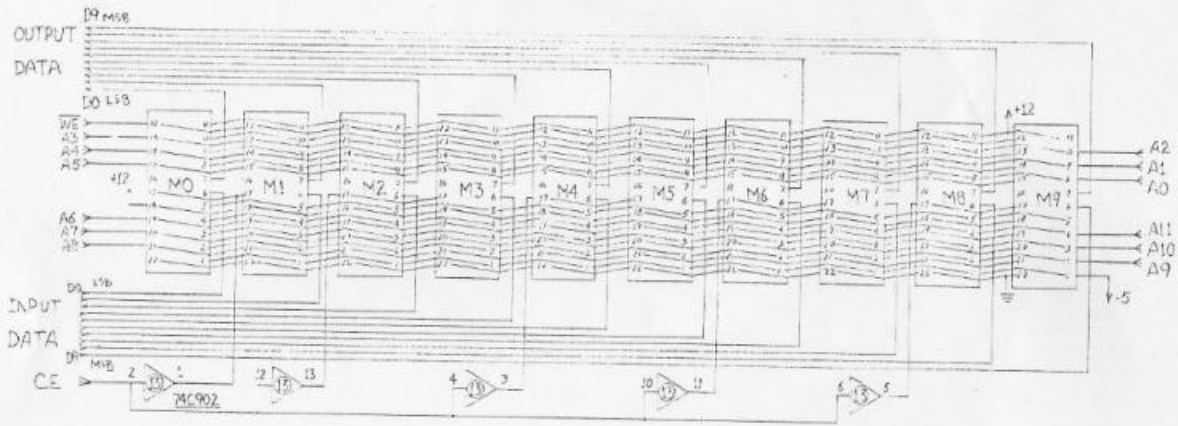

HD 910 PAGE 4 OF 4
 MEMORY ARRAY AND (REV.C)
 INTERBOARD CONNECTORS

REVISED 1970
 Drawings furnished for
 reference purposes only
 and not to be copied without
 written permission.
 Copyright 1976