

**MODEL 160A**

---

**COMPRESSOR /  
LIMITER**

**dbx<sup>®</sup>**  
OPERATION MANUAL



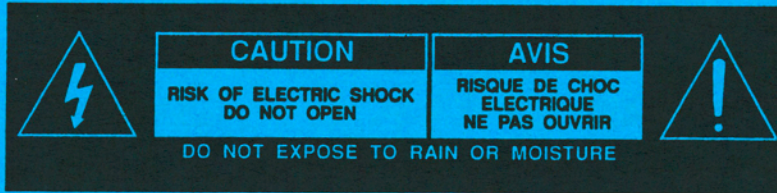

**CAUTION:** TO REDUCE THE RISK OF ELECTRICAL SHOCK, DO NOT REMOVE COVER (OR BACK). NO USER SERVICEABLE PARTS INSIDE. REFER SERVICING TO QUALIFIED SERVICE PERSONNEL.

**WARNING:** TO REDUCE THE RISK OF FIRE OR ELECTRICAL SHOCK, DO NOT EXPOSE THIS APPLIANCE TO RAIN OR MOISTURE.



This symbol, wherever it appears, alerts you to the presence of uninsulated dangerous voltage inside the enclosure — voltage that may be sufficient to constitute a risk of shock.



This symbol, wherever it appears, alerts you to important operating and maintenance instructions in the accompanying literature. Read the manual.

This Manual is part number 18-2040-B

© Copyright 1995 by dbx Professional Products

**dbx**

dbx Professional Products  
8760 South Sandy Parkway  
Sandy, UT 84070  
Telephone (801) 568-7660  
Fax (801) 568-7662

**H** A Harman International Company





## CAUTION

RISK OF ELECTRIC SHOCK  
DO NOT OPEN



**ATTENTION:** RISQUE DE CHOC ELECTRIQUE - NE PAS OUVRIR

**WARNING:** TO REDUCE THE RISK OF FIRE OR ELECTRIC SHOCK DO NOT EXPOSE THIS EQUIPMENT TO RAIN OR MOISTURE

The symbols shown above are internationally accepted symbols that warn of potential hazards with electrical products. The lightning flash with arrowpoint in an equilateral triangle means that there are dangerous voltages present within the unit. The exclamation point in an equilateral triangle indicates that it is necessary for the user to refer to the owner's manual.

These symbols warn that there are no user serviceable parts inside the unit. Do not open the unit. Do not attempt to service the unit yourself. Refer all servicing to qualified personnel. Opening the chassis for any reason will void the manufacturer's warranty. Do not get the unit wet. If liquid is spilled on the unit, shut it off immediately and take it to a dealer for service. Disconnect the unit during storms to prevent damage.

## WARNING

### FOR YOUR PROTECTION, PLEASE READ THE FOLLOWING:

**WATER AND MOISTURE:** Appliance should not be used near water (e.g. near a bathtub, washbowl, kitchen sink, laundry tub, in a wet basement, or near a swimming pool, etc). Care should be taken so that objects do not fall and liquids are not spilled into the enclosure through openings.

**POWER SOURCES:** The appliance should be connected to a power supply only of the type described in the operating instructions or as marked on the appliance.

**GROUNDING OR POLARIZATION:** Precautions should be taken so that the grounding or polarization means of an appliance is not defeated.

**POWER CORD PROTECTION:** Power supply cords should be routed so that they are not likely to be walked on or pinched by items placed upon or against them, paying particular attention to cords at plugs, convenience receptacles, and the point where they exit from the appliance.

**SERVICING:** To reduce the risk of fire or electric shock, the user should not attempt to service the appliance beyond that described in the operating instructions. All other servicing should be referred to qualified service personnel.

**FOR UNITS EQUIPPED WITH EXTERNALLY ACCESSIBLE FUSE RECEPTACLE:** Replace fuse with same type and rating only.

## U.K. MAINS PLUG WARNING

A moulded mains plug that has been cut off from the cord is unsafe. Discard the mains plug at a suitable disposal facility. **NEVER UNDER ANY CIRCUMSTANCES SHOULD YOU INSERT A DAMAGED OR CUT MAINS PLUG INTO A 13 AMP POWER SOCKET.** Do not use the mains plug without the fuse cover in place. Replacement fuse covers can be obtained from your local retailer. Replacement fuses are 13 amps and **MUST** be ASTA approved to BS1362.

## ELECTROMAGNETIC COMPATIBILITY

This unit conforms to the Product Specifications noted on the Declaration of Conformity. Operation is subject to the following two conditions:

- this device may not cause harmful interference, and
- this device must accept any interference received, including interference that may cause undesired operation.

Operation of this unit within significant electromagnetic fields should be avoided. Use only shielded interconnecting cables.

## SAFETY INSTRUCTIONS

**NOTICE FOR CUSTOMERS IF YOUR UNIT IS EQUIPPED WITH A POWER CORD.**

**WARNING: THIS APPLIANCE MUST BE EARTHED.**

The cores in the mains lead are coloured in accordance with the following code:

GREEN and YELLOW - Earth    BLUE - Neutral    BROWN - Live

As colours of the cores in the mains lead of this appliance may not correspond with the coloured markings identifying the terminals in your plug, proceed as follows:

- The core which is coloured green and yellow must be connected to the terminal in the plug marked with the letter E, or with the earth symbol, or coloured green, or green and yellow.
- The core which is coloured blue must be connected to the terminal marked N or coloured black.
- The core which is coloured brown must be connected to the terminal marked L or coloured red.

This equipment may require the use of a different line cord, attachment plug, or both, depending on the available power source at installation. If the attachment plug needs to be changed, refer servicing to qualified service personnel who should refer to the table below. The green/yellow wire shall be connected directly to the unit's chassis.

CONDUCTOR		WIRE COLOR	
		Normal	Alt
L	LIVE	BROWN	BLACK
N	NEUTRAL	BLUE	WHITE
E	EARTH GND	GREEN/YEL	GREEN

**WARNING:** If the ground is defeated, certain fault conditions in the unit or in the system to which it is connected can result in full line voltage between chassis and earth ground. Severe injury or death can then result if the chassis and earth ground are touched simultaneously.

## DECLARATION OF CONFORMITY

Manufacturer's Name: dbx Professional Products  
Manufacturer's Address: 8760 S. Sandy Parkway  
Sandy, Utah 84070, USA

declares that the product:

dbx 160A

conforms to the following Product Specifications:

Safety: EN 60065 (1993)  
IEC65 (1985) with Amendments 1, 2, 3

EMC: EN 55013 (1990)  
EN 55020 (1991)

Supplementary Information:

The product herewith complies with the requirements of the Low Voltage Directive 73/23/EEC and the EMC Directive 89/336/EEC as amended by Directive 93/68/EEC.

dbx Professional Products  
Vice-President of Engineering  
8760 S. Sandy Parkway  
Sandy, Utah, 84070, USA  
January 2, 1997

European Contact: Your Local dbx Sales and Service Office or International Sales Office

68 Sheila Lane  
Valparaiso, Indiana  
46383, USA

Tel: (219) 462-0938  
Fax: (219) 462-4596

# SPECIFICATIONS

Input (1/4" TRS Phone and XLR)	Floating Balanced; XLR: Pin 2 Hot, Phone: Tip Hot
Impedance	>40 k $\Omega$
Maximum Level	+24dBu, Balanced or Unbalanced
CMRR	>45 dB
Detector Input (1/4" TRS Phone)	Floating Balanced; Pin 2 Hot
Impedance	>200 k $\Omega$
Maximum Level	+28 dBu, Balanced or Unbalanced
Output (XLR)	Floating Balanced; Pin 2 Hot
Impedance	30 $\Omega$
Maximum Level (Balanced)	+24 dBm; <0.3% THD
Maximum Level (Unbalanced)	+20 dBm; <0.3% THD
Noise	<-90 dBu, Unweighted (20 Hz - 20 kHz)
Frequency Response	20 Hz - 20 kHz, +0, -0.5 dB; +0, -3 dB 0.5 Hz and 90 kHz
THD	<0.2%, Typical, Any Amount of Compression up to 40 dB @ 1 kHz
Output ( 1/4" TRS Phone)	
Balancing	Unbalanced
Impedance	20 $\Omega$
Maximum Level	+24 dBm
Dynamic Range	>113 dB
Gain Adjustment Range	Variable from -20 dB to +20 dB
Threshold Range	-40 dBu to +20 dBu
Threshold Characteristic	Selectable OverEasy® or Hard Knee
Compression Ratio	Variable 1:1 to $\infty$ :1 through to -1:1; >60 dB Maximum Compression
Attack Time	Program-Dependent; Typically 15ms for 10 dB, 5 ms for 20 dB, 3 ms for 30 dB
Release Time	Program-Dependent; Typically 8ms for 1dB,, 80ms for 10dB, 400 ms for 50 dB; 125 dB/Sec Rate
Stereo Coupling	True RMS Power Summing™; 1/4" TRS Phone Jack
Power Cord	IEC-Type Connector
Input Ratings	100 VAC 50/60 Hz, 120 VAC 60 Hz 230 VAC 50/60 Hz
Power Consumption	15 W
Operating Temperature	0° C to 45° C (32° F to 113° F)
Dimensions (H x W x D)	1.75" x 19" x 6.5" (4.45cm x 48.2cm x 16.51cm)
Rack Space	1 Rack Unit (1U High)
Weight	Net Weight: 4.415 lbs (1.99 kg). Shipping Weight: 6.62 lbs (2.99 kg).

Notes: Noise and frequency response specifications are at unity gain.  
0dBV = 1.0VRMS; 0dBu = 0.775VRMS.

Specifications are subject to change.



## QUICK SETUP

---

To get your unit up and running as quickly as possible, do the following steps. For more detailed information, refer to the specified pages.

- |   |         |
|---|---------|
| <input type="checkbox"/> Unpack and Inspect the 160A Package. | Page 1  |
| <input type="checkbox"/> Set Levels and Controls as Needed.   | Page 2  |
| <input type="checkbox"/> Connect the 160A to Your System.     | Page 10 |

## INSPECTION

---

### 1. Verify that the 160A package contains the following:

- 160A Unit
- AC Power Cord
- Operation Manual (including Registration Card)

## INTRODUCTION

---

Congratulations on purchasing the dbx 160A Compressor/Limiter. We recommend you take a moment and read through the manual as it provides information that will assist you from system installation to operation to special applications. Features include:

- OverEasy<sup>®</sup>/Hard Knee Selection – allows selection between our famous OverEasy compression curve and the classic “Hard Knee” curve popularized by the original dbx 160, 161 and 162.
- True RMS Level Detection – senses the power in the program in a musical manner, much as the ear does, giving results superior to peak or average detection.
- Hardwire System Bypass Button – allows the audio to pass even if the unit is unplugged, and is also useful for comparing the processed and unprocessed signal.
- Front Panel SLAVE Button – couples two 160As together for stereo operation at the push of a button. Note: a 160A unit cannot be stereo-coupled with a dbx 160XT, 160X, 160, 161 or 162 unit.
- True Power Summing – When two 160A units are slaved together, the RMS energy of the signal presented to the slave unit is summed with the RMS energy of the signal presented to the master unit to prevent phase cancellation of the two signals from causing unmusical compressor action.
- LED Displays – 19-Segment LED Display for high resolution monitoring of True RMS INPUT and OUTPUT LEVELs; 12-Segment LED Display for GAIN REDUCTION (up to 40dB).
- Meter Calibration – Input/Output meter calibration, so the 160A can be used in a variety of situations where the “0” reference is not consistent.
- XLR-type Input and Output Jacks – because the 3-pin XLR connector has been recognized as the most durable and widely used connector for professional applications. (An optional output transformer is available.)
- 1/4” Input and Output Jacks – with the output capable of driving its own additional 600Ω load (single-ended) in addition to any load on the XLR output.
- Input Ground Lift Switch – internally disconnects pin 1 of the input XLR jack from 160A chassis ground to eliminate any ground loop hum problems that may arise.
- Detector Input – useful for special applications including frequency conscious compression in which an external equalizer is used.
- DC-controlled Parameters – the signal does not pass thru any of the parameter controls. Instead a DC voltage controls all functions; this eliminates any possibility of potentiometer noise developing over time.



## Applications

The dbx 160A is capable of handling a wide range of applications. In the studio, the 160A can be used on everything from vocals to percussion. In live sound reinforcement, the 160A can allow the engineer to get that "fat studio sound" out of the drum kit or provide protection limiting for the speakers. It is also an excellent line driver, perfect for sending signals down long cables to power amp stacks or from remote broadcast trucks. In radio or television broadcast, the 160A will produce stable voice levels, even with non-professional subjects.

## OPERATING CONTROLS

### Front Panel

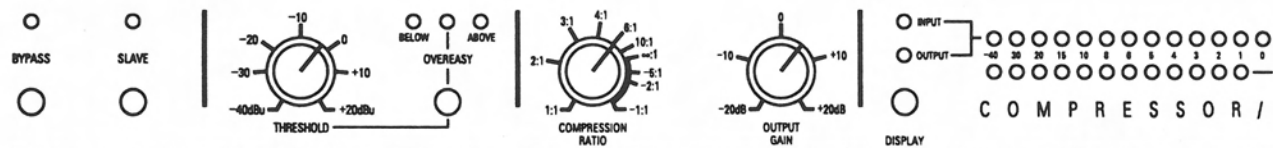

**BYPASS Button and LED:** Depress this button to create a "hard-wire bypass" of the 160A's circuitry (i.e., unaltered input signal will pass through the unit even if it is unplugged).

In Bypass mode, the input is sent directly to the output, bypassing the 160A's processing and controls and presenting unaltered input signal at the 160A's OUTPUT. Bypass mode is especially useful for making comparisons between processed and unprocessed signals.

The BYPASS LED turns On in Bypass mode if the 160A is being provided with AC power.

**SLAVE Button and LED:** When two 160As are connected via their rear panel STEREO STRAPPING jacks, depressing the SLAVE button on one 160A of the stereo pair determines that the *other* 160A will be the Master (i.e., the controlling unit).

Note: When two 160As are strapped together and the SLAVE buttons on both units are NOT depressed, the 160As DO NOT operate independently because the "ring" of the strapping cable still sums the audio of each unit. The strapping cable must be removed for proper single-channel operation. If both SLAVE buttons are depressed, both units will be bypassed (i.e., fixed at unity gain).

The LED above the SLAVE button turns On when the 160A is in Slave mode, indicating that the front panel functions (with the exception of BYPASS and LEVEL display) are deactivated and under control of the Master 160A.

**THRESHOLD Control:** Adjust this knob to set the threshold of compression from  $-40\text{dBu}$  ( $7.8\text{mVRMS}$ ) to  $+20\text{dBu}$  ( $7.8\text{VRMS}$ ).

**OverEasy Button:** Depress this button to select the OverEasy<sup>®</sup> compression characteristic. The amber THRESHOLD LED turns On when the signal is in the OverEasy region. When this button is out, the 160A operates as a hard knee compressor/limiter.

In Hard Knee mode, the threshold of compression is defined as that point above which the output level no longer changes on a 1:1 basis with changes in the input level. See Figure 1.

In OverEasy mode, the threshold of compression is defined as the middle of the OverEasy threshold region, that is, "half-way" into compression, as shown in Figure 2.



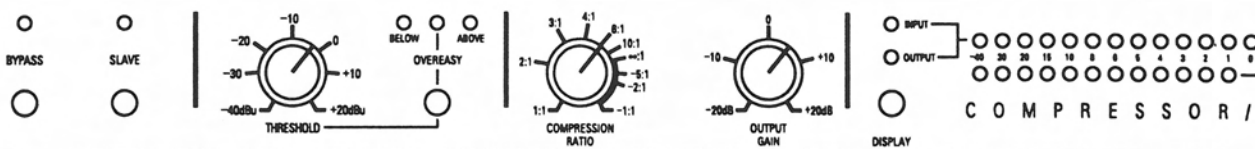

**THRESHOLD LEDs:** These three LEDs indicate the relationship of the input signal level to the threshold of compression. The green "BELOW" LED is On when the signal is below threshold and the red "ABOVE" LED is On when the signal is above threshold. When the 160A is switched to OverEasy mode, the amber LED is On when the signal is in the OverEasy region (See Figure 2).

**COMPRESSION RATIO Control:** Rotate this control clockwise to increase the amount of compression from 1:1 (no compression) up to infinity:1 (no increase in output level, regardless of input level increases above threshold); further clockwise rotation increases compression into the INFINITY+ region, up to a maximum of -1:1 (i.e., a 1dB increase in input level above threshold causes a 1dB decrease in output level). In the INFINITY+ region, the 160A inverts the program dynamics for special effects.

**OUTPUT GAIN Control:** Adjust this control to vary the amount of fixed gain (up to  $\pm 20$ dB) in the 160A's output amplifier stage. The OUTPUT GAIN control does not interact with the threshold of compression.

**DISPLAY Button and LED:** Depress this button to make the upper LED array display the INPUT LEVEL to the 160A. With the button out, the OUTPUT LEVEL is displayed. A pair of LEDs immediately above the DISPLAY button indicates the selected display.

**INPUT/OUTPUT LEVEL and GAIN REDUCTION Displays:** The upper row of 19 LEDs displays either the INPUT or OUTPUT LEVEL, as selected with the DISPLAY button. This display is factory set so that 0dB is equivalent to +4dBu input or output level (1.23VRMS), but may be reset with the rear panel METER CALIBRATION trimmer. (See following pages.)

The lower row of 12 LEDs displays up to 40dB of GAIN REDUCTION (although the 160A is actually capable of delivering up to 60dB of gain reduction). Note that fixed gain changes due to the OUTPUT GAIN control are not displayed by the GAIN REDUCTION LEDs but are reflected in the OUTPUT LEVEL display.

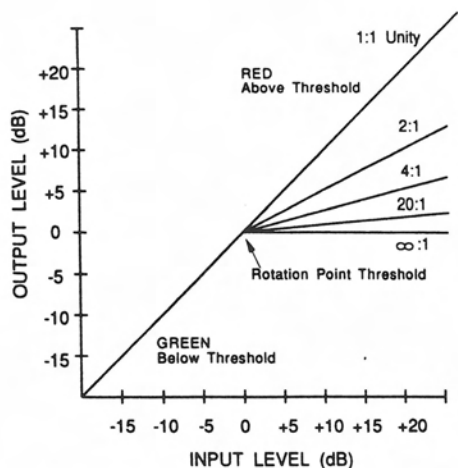

Figure 1: Hard Knee Compression Curve and Threshold LEDs

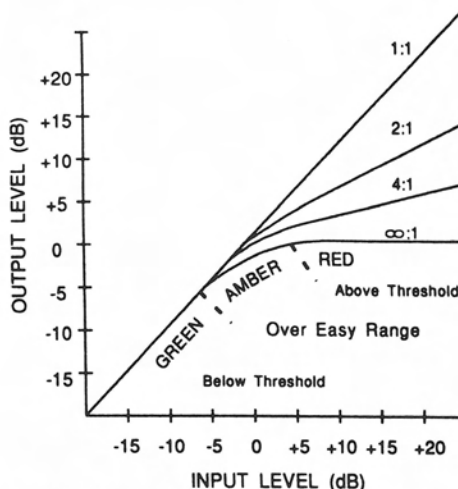
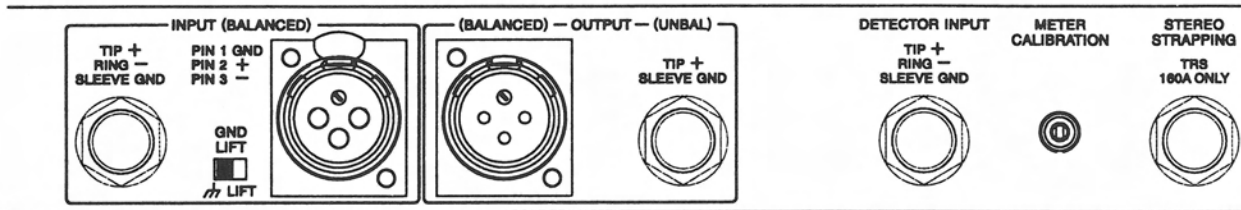

Figure 2: Over Easy Compression Curve and Threshold LEDs



## Rear Panel



**INPUT (BALANCED) Jacks:** The Tip/Ring/Sleeve phone jack and XLR-type jack are wired in parallel; either INPUT will accept an audio signal for processing by the 160A. The phone jack accepts a standard TRS 1/4" phone plug for a balanced input source, or a 2-circuit (Tip/Sleeve) 1/4" phone plug for an unbalanced source. The XLR-type jack is wired pin 2 HOT (+), pin 3 COLD (-) and pin 1 GROUND.

**OUTPUT (BALANCED) Jack:** The 160A's OUTPUT (BALANCED) jack is driven by a floating active-balanced amplifier that simulates a true transformer output. This allows for the load at the OUTPUT to be either balanced with respect to ground, or single-ended to ground (unbalanced) with very little difference (less than 0.5dB) in output level. *For proper unbalanced operation, the unused pin (either pin 2 or 3) MUST be grounded.*

Nominal output signal level is +4dBu into 600Ω, and typical maximum output level is +25dBu into 600Ω. This jack accepts XLR-type connectors, wired pin 2 HOT (+), pin 3 COLD (-) and pin 1 chassis ground.

For applications which require a "true" transformer output, an optional output transformer can be installed. Contact our Customer Service Department at the phone number listed on the inside cover for details. If outside the United States, contact your dbx distributor.

**OUTPUT (UNBAL) Jack:** The 160A has a separate single-ended (unbalanced) output amplifier capable of driving a 600Ω (or greater) load to +24dBu. This jack accepts 1/4" phone plugs. In normal operation the TRS phone jack is internally wired with the TIP HOT (+), and the RING and SLEEVE connected to ground. In Bypass mode, however, the RING is connected to the COLD (-) leads of the input jacks, to allow for balanced connections.

**GROUND (GND) Lift Switch:** This switch allows for troubleshooting hum (line interference) caused by ground loops. In the "GND" position, pin 1 of the input XLR-type jack is connected to the 160A's chassis ground. In the "LIFT" position it is disconnected.

**DETECTOR INPUT Jack:** This Tip/Ring/Sleeve phone jack accepts a standard TRS 1/4" phone plug, and is of the "normalling" type (i.e., when a phone plug is inserted, the detector input is no longer connected in parallel with the audio input). The DETECTOR INPUT jack accepts balanced or unbalanced sources, independent of other jacks.

**METER CALIBRATION Control:** This screwdriver-adjustable trimmer may be used to precisely calibrate the front panel's upper LED display so a 0dB INPUT or OUTPUT indication is equivalent to any signal from -15dBu (138mVRMS) to +10dBu (2.45VRMS).

**STEREO STRAPPING Jack:** When a TRS (Tip/Ring/Sleeve) 1/4" phone plug patch cable is inserted between two 160As, stereo strapping can be achieved by depressing the SLAVE switch on one unit only. This will provide accurate processing for stereo programming.

**AC Power Jack:** This jack accepts an IEC-type power cord (as shipped with the unit). Plug the cord into the unit and mains power. Note that the 160A does not have a power switch. It is recommended that the 160A be "On" at all times. Power consumption is low. If you do not plan to use the 160A for an extended period of time, unplug it.

**Warning:** Be sure to verify both your actual line voltage and the voltage for which your Model 160A was wired, as indicated on the rear panel of your unit. Connection to an inappropriate power source may result in extensive damage which is not covered by the warranty.



## OPERATING NOTES

### Basic Operation

#### Using the THRESHOLD Control

In Hard Knee mode (OVEREASY button out), THRESHOLD sets a reference level above which input signals will be processed by the 160A's gain change circuitry in the manner defined by the setting of the RATIO control. Input signals which fall below this level will pass through the 160A unprocessed (except for fixed gain changes directed by the OUTPUT GAIN control). See Figure 1.

In OverEasy Mode (OVEREASY button depressed), signals begin to gradually activate the 160A's gain change circuitry as they approach the THRESHOLD reference level and they do not get fully processed in the manner defined by the RATIO control until they have passed somewhat above the THRESHOLD reference level. In OverEasy mode there is no distinct point at which processing begins, and the THRESHOLD setting corresponds to a point on the input/output transfer curve midway between the onset of processing and that point at which the transfer curve corresponds to the setting of the RATIO control. Figure 2 shows the OverEasy compression curves and how they correlate with the THRESHOLD LEDs.

**Note:** The THRESHOLD setting always relates to the signal level seen by the 160A's DETECTOR circuitry. In normal operation (i.e., sending audio to the INPUT jack *only*), the 160A actually responds to the DETECTOR INPUT which is wired internally in parallel to the INPUT. This concept is important to understand because the parallel connection is broken when you insert signal into both input jacks. In this case, as you might suspect, the signal present at the DETECTOR INPUT determines how the 160A processes the signal coming into its INPUT (refer to Sidechain Applications, page 8). Note that the DETECTOR INPUT does not feed signal to the OUTPUT and therefore cannot be used as a substitute for the INPUT.

#### Using the COMPRESSION RATIO Control

When an input signal is above the THRESHOLD reference level, the setting of this control determines the number of decibels by which the input signal must change in level to produce a 1dB increase in the signal level at the output of the 160A. A setting of 2:1 indicates an input:output ratio wherein a 2dB increase in signal (above threshold) will produce a 1dB increase in output signal. A setting of  $\infty$ :1 indicates that an infinite increase in input level would be required to raise the output level by 1dB. In other words, the output level stays constant when the input signal rises above threshold.

The 160A's RATIO control covers the entire range from 1:1 to  $\infty$ :1 and, in addition, goes to Infinity+ (negative) ratios. At a setting of -1:1, the above threshold input signal must increase by 1dB in level to decrease the signal at the output of the 160A by 1dB. See Figure 3. The control curve of the RATIO potentiometer has been designed to provide total operator control, with scale expansion at the subtle lower ratios for easy, repeatable settings.

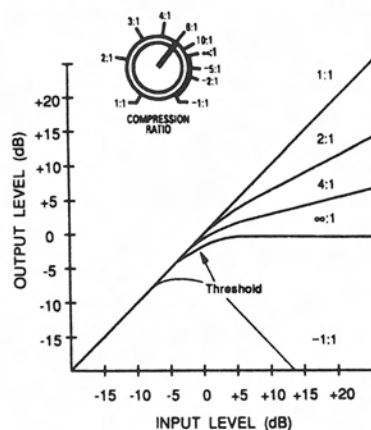

**Figure 3: Ratio Control and Infinity+ (Negative) Ratios**



## METER CALIBRATION Control

The INPUT/OUTPUT LEVEL display in the 160A is factory-calibrated to indicate "0" when the signal is +4dBu (1.23VRMS) at either the input or output of the 160A, depending on the position of the DISPLAY button. (The METER CALIBRATION control does not affect the GAIN REDUCTION LEDs.)

To recalibrate the LEVEL display, depress the DISPLAY button to meter the INPUT LEVEL, and feed a 1kHz signal at the selected nominal operating level (the level desired for a "0dB" meter indication) to the 160A's INPUT. Then adjust the rear panel METER CALIBRATION control until the meter indicates "0dB."

## Specific Applications

**Note:** Control settings for each application are suggested as a starting point. Adjust them for your requirements.

### Smoothing Out Variations in Microphone Levels

Variations in signal level can occur when the distance between a vocalist and a mic changes, or when the dynamics of a voice changes relative to a vocalist's range. To smooth out these variations, start with the 160A in OverEasy mode and adjusted for a low to medium COMPRESSION RATIO (e.g., 4:1). Adjust the THRESHOLD control so that the GAIN REDUCTION meters show 6dB to 10dB of gain reduction, then increase COMPRESSION RATIO if necessary. Due to the gentle OverEasy characteristic of your 160A you will find that even fairly high ratios are handled transparently.

### Smoothing Out Variations (and Increasing Sustain) in Musical Instrument Levels (e.g., Bass Guitar, Electric Guitar, Synthesizer)

To achieve a smoother electric (or electronic) bass sound, compress the instrument's output with a COMPRESSION RATIO of approximately 4:1, then adjust the THRESHOLD control for 10dB to 12dB of gain reduction. Compression lessens the loudness variations among the strings *and* increases the bass' inherent sustain. Other instruments, such as horns, vary in loudness depending on the note being played, and benefit similarly.

To control untimely volume shifts in "hot" guitar or synth parts and to keep them from overloading your tape deck or mixer during recording and live performances, start with the COMPRESSION RATIO at approximately 5:1 and the THRESHOLD set to the average maximum level of the track — this will ensure that only the offending "hot" part is compressed. Adjust both controls as necessary.

To add sustain to guitar or synthesizer string sounds, begin with a higher COMPRESSION RATIO (from 10:1 to ∞:1), then adjust the THRESHOLD control to taste. For example, you can use a compressor to alter the envelope of a synth patch to create an otherworldly synth pad that has just the right amount of body and soul without losing its initial impact: begin with a synth sound that has a bite on its attack, but ends with a long release time. While playing slow, but steady, synth stabs or chords, compress the sound heavily; adjust the THRESHOLD to taste and toggle between OverEasy and Hard Knee modes to hear the effect each mode has on the attack and release of the envelope. Heavy compression of guitars and synths, as they are being recorded to digital formats, can often help revive their sense of "analog life."

Negative ratios alter the envelope of a sound differently than high compression ratios. With the 160A in the path of a synth or guitar, set the COMPRESSION RATIO to -1:1, -2:1 or -5:1. Methodically strike a series of chords and listen to how the compression softens the attack and quickens the release. Adjust the THRESHOLD and experiment with different types of sounds and 160A settings.

Negative ratios can also be used to prevent musicians from continually increasing the volume of their instrument (e.g., in live applications where there is no sound engineer to control the house levels). With their signal compressed by a negative COMPRESSION RATIO, each volume increase initiated at the instrument or amp would actually decrease the volume level at the final mix.

### Fattening Kick Drums and Compressing Other Drums

Weak, flabby kick drums often have too much boom, and not enough slap. To tighten them up, start with the 160A adjusted for a medium to high COMPRESSION RATIO (e.g., 6:1), adjust the THRESHOLD control so that the GAIN REDUCTION meters show 15dB of gain reduction, then increase the COMPRESSION RATIO if necessary. In OverEasy

mode, the 160A takes slightly longer to react than in Hard Knee mode, and will therefore emphasize the slap at the beginning of the note and reduce the boominess of its body. The 160A also works well for tightening snare drums and tom toms and can be used with drum machines to effectively alter the character of any electronic drum sound.

For drum kit submixes (e.g., mixing multiple drum tracks to two tracks while using two 160As for compression), consider backing off the COMPRESSION RATIO on each 160A (down to 2:1) to avoid an excess of cymbal "splattering." In larger multitracking systems, compress the kick and snare separately. A further possibility (if you have two more compressors) is to heavily compress a stereo submix of toms and leave the remaining percussives unaffected.

### Raising a Signal Out of a Mix

Since reducing dynamic range increases the *average* signal level by a small amount, a single track can be raised out of a mix by boosting its level slightly and applying compression. Start with a 2:1 COMPRESSION RATIO and a relatively low THRESHOLD setting (–20dB). Adjust both controls as necessary.

Compressors have also been used to bring vocals to the forefront of a mix in volume-restricted studios (e.g. home studios). Start by adding a foam windscreen to the mic (if it doesn't have one). Set the COMPRESSION RATIO to 10:1 and the THRESHOLD to –10dB. With your mouth approximately 2 inches from the mic, sing the vocal part, but with less volume than normal. Use phrasing to give the part some intensity. An equalizer (e.g., a dbx 1531X Graphic Equalizer) or a vocal effects device (e.g., reverb, delay, distortion) can be added to further toughen the performance.

It is also possible to separate certain vocals or instruments from a mono program already mixed: refer to frequency-weighted compression on page 8.

**Note:** When compressing a stereo program with a pair of 160As, the factors affecting a compression curve and the actual COMPRESSION RATIO and THRESHOLD settings, are like those previously covered with reference to single channels of program material. However, it will generally be found that large amounts of compression are more audible in a mixed stereo program than they might be on the separate tracks that were mixed to create the program.

### Preventing Tape Saturation

With programs of widely varying levels, compression can prevent recording levels (e.g., cymbal tracks in a final mix or drum kit submix) from saturating tape tracks (see frequency-weighted compression, below).

### Preventing Digital Overload

Some digital recorders and samplers produce audible distortion when they exceed their headroom (i.e., the range above their normal operating level). The 160A effectively ensures that audio input does not overload a digital recorder's D/A (digital-to-analog) converters. The 160A can perform this compression quietly enough for all digital media. Set the 160A for limiting with Hard Knee mode On, the COMPRESSION RATIO to  $\infty$ :1, and set the THRESHOLD 2 to 3dB below the overload point of the recorder.

### Speaker Protection (Auditoriums, Churches, Mobile DJs and Sound Systems)

Compressors are frequently used to prevent excessive program levels from damaging drivers in a sound-reinforcement system (whether you're doing auditorium, church, or club sound engineering, or are a mobile DJ for small dances, or like to push the limits your home's audio entertainment center). Set the 160A for limiting (Hard Knee mode On, with a COMPRESSION RATIO of 10:1 or greater) and adjust the THRESHOLD to provide 15dB or more of compression (just a few dB below the input clip). For low-level signals, the 160A won't change gain, but if large signals come along, the gain will be reduced to prevent clipping and save sensitive system components from excessive heat buildup or other type of damage.

In circumstances where the 160A is expected to cause no change in gain unless an emergency arises (wildly excessive levels), some operators set Hard Knee mode On, the COMPRESSION RATIO to  $\infty$ :1, and the THRESHOLD to the highest permissible level.

As a general rule, compressors should be *as close to the amplifiers as possible* in the signal chain. If the 160A is placed before the EQ (equalizer), for example, a potentially damaging boost in the EQ won't be seen by the 160A and the speakers may be damaged. (see Multi-way speaker systems, page 9). For maximum sound pressure levels, large sound reinforcement systems frequently use a separate compressor on each output of the electronic crossover(s).



For a stereo sound-reinforcement system, stereo strapping cables should be run between the 160As in each band (low-low, mid-mid, etc.).

### Raising Average Level in PA Systems

Limiting (i.e., compression at high ratios like  $\infty:1$ ) also benefits intelligibility by allowing low-level input signals to be reproduced through the system at higher volume. In a musical performance, this provides additional intimacy as the vocalist's whispers are heard clearly at every seat in the house. The OverEasy curve available with the 160A permits a very high amount of compression (COMPRESSION RATIO of 10:1 or greater) to be used in many situations. This allows dynamic speakers, vocalists and other musicians to concentrate on their presentation or performance without worrying about the ill effects of volume changes.

### Using Your EQ to Reduce Feedback in Live Settings (Indoor and Outdoor Concerts, Churches)

You can use your 160A and EQ (equalizer) to reduce feedback in clubs, churches, outdoor concerts and other live settings. Patch or insert the 160A into the main output of a mixer, set the 160A to Hard Knee mode and slowly increase GAIN CONTROL until the first feedback "ring" occurs, then set up the 160A with its COMPRESSION RATIO at  $\infty:1$  and THRESHOLD low. The 160A will catch the first feedback ring and hold it as a constant tone so you can adjust your EQ to minimize it. Continue to increase your console gain and set your EQ until the next 3 or 4 "ring" frequencies have been compensated for.

### The 160A as a Line Amplifier

To use the 160A as a line amplifier, adjust the COMPRESSION RATIO control fully counterclockwise (1:1 position), THRESHOLD fully clockwise (+20) and OUTPUT GAIN to whatever setting is required for the application. Remember, excessive gain may lead to output clipping of high level signals. To add compression, adjust the COMPRESSION RATIO and the THRESHOLD controls to the desired settings.

### Frequency-Weighted Compression (Sidechain Application)

It is possible to separate certain vocals and instruments from a mix by frequency-weighted compression. With an equalizer (such as a dbx Project 1 242, or a dbx 1531X) inserted ahead of the DETECTOR INPUT (but not in the audio path), the equalization settings do not shift the timbre or frequency response of the audio signal. They merely alter the threshold response of the compressor on a "frequency-weighted" basis.

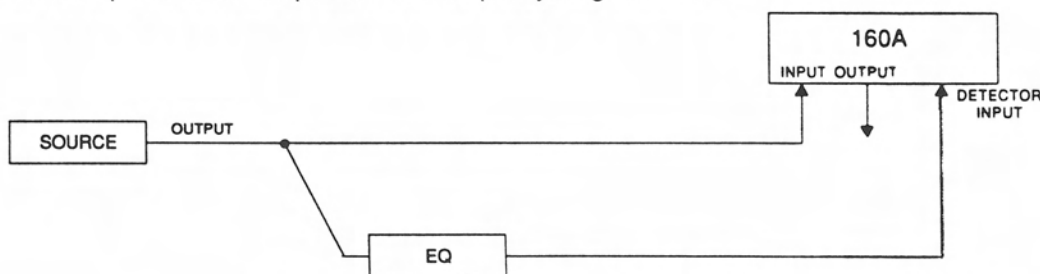

Figure 4: Frequency-Weighted Compression

With this arrangement, raising certain frequencies on the equalizer causes them to be suppressed in the audio signal. A relatively high THRESHOLD setting can allow normal sounds to be unaffected while solo and very loud sounds are compressed. (Of course, when compression occurs, the level of the entire program is affected.) Depending on the THRESHOLD setting, lower level fundamentals or harmonics will not cause compression, and the program is not subject to the phase shift normally caused by program equalization.

When recording cymbals and tom-toms, a compressor with an equalizer in the detector path can help prevent tape saturation. The equalizer can be adjusted for boost with a peak of about 5kHz, causing the cymbal to be compressed on a very loud crash, stopping tape saturation at high frequencies, where there is less headroom. However, gentle tapping of a drumstick or brushing of the cymbal will not be affected. Assuming the tom-tom is a lower frequency instrument and can be better tolerated by the tape, it has less need for compression. Equalization in the detector circuit means that the compressor is not triggered as readily by a loud tom-tom beat as by an equally loud cymbal crash.

The converse of the above EQ technique may be used: dipping the equalizer bands causes any sound with dominant energy in the affected register to pull the level up because the 160A will detect a need for less compression.

### De-Essing

To apply de-essing to vocals (i.e., a reduction of sibilance), use a parametric equalizer in the level detector circuit and set it for high frequency boost in the specific frequency range where the vocal "hiss" or lisp occurs (generally in the 4-6kHz region). This pre-emphasizes the already "hissy" vocal input to the detector. Used in conjunction with a moderate to high THRESHOLD and COMPRESSION RATIO, this arrangement greatly attenuates the "essing" without affecting the basic sound quality or balance of the voice. While it is true that all frequencies are lowered in level when the compressor is triggered, generally the "sss" sound occurs alone, before or after the dominant tone in the voice.

### Increasing Sustain

To increase the sustain of a musical instrument (e.g., a guitar or bass), use an equalizer in the level detector circuit and boost the EQ in the dominant frequency range of the instrument. Set the 160A to Hard Knee mode, with a fairly low THRESHOLD and a moderate COMPRESSION RATIO.

### Multi-Way Speaker Systems

If a single compressor is to be used with a multi-way speaker system (i.e., before the crossover, after the EQ), the system operator is faced with the problem of keeping levels below the point of damage of the most sensitive part of the system. If, for example, mid-range drivers are frequently damaged, the whole system must be operated at a lower sound-pressure level, or additional mid-range drivers must be added. By inserting an equalizer in the detector path to the 160A, it can be made more sensitive to frequencies in the range handled by the sensitive drivers. The system can then be run at higher levels and will only be dropped back when damaging signals are present.

### Using a Filter in the Level Detector Circuit

The results of inserting a filter in the level detector circuit are basically the same as obtained with an equalizer, as previously described. Those frequencies passed by the filter are subject to compression (or at least they are subject to considerably more compression than those frequencies outside the passband). Because a passive filter can have insertion loss, it may be necessary to lower the 160A's THRESHOLD setting to maintain a given amount of gain reduction within the filter passband; this can be determined by monitoring the 160A's THRESHOLD LEDs.

### Pre-Emphasis for Broadcast Applications

By inserting a pre-emphasis filter network in the detector path of a 160A processing pre-emphasized audio, higher levels can be run within the headroom limitations of the broadcast chain.

### Anticipated Compression (Sidechain Application)

By feeding the program directly to the 160A's detector input and sending the audio signal through a delay line before the audio input, the unit can anticipate the need for a gain change. With some experimentation, the effect can be that of zero attack time at a given frequency. Additional signal delays beyond this zero time will then cause the compressor to finish reducing the gain before the leading edge of the loud passage even enters the signal input. This will suppress the program material preceding this loud passage. The 160A will then begin to release (recover from compression) before the loud passage has ended.

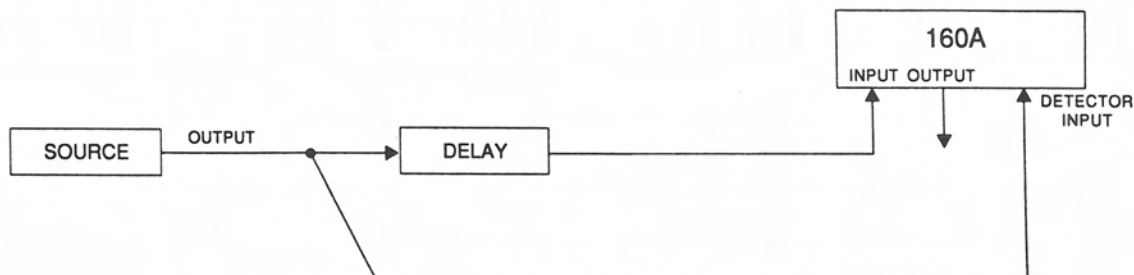

Figure 5: Anticipated Compression



## CONNECTING THE 160A TO YOUR SYSTEM

### Basic Connection

The 160A has balanced inputs and outputs, and can be used with any line-level device. Some common examples include: mixing consoles, musical instruments, patch bays and other signal processors. For more specific cabling information, refer to Installation Considerations, page 13.

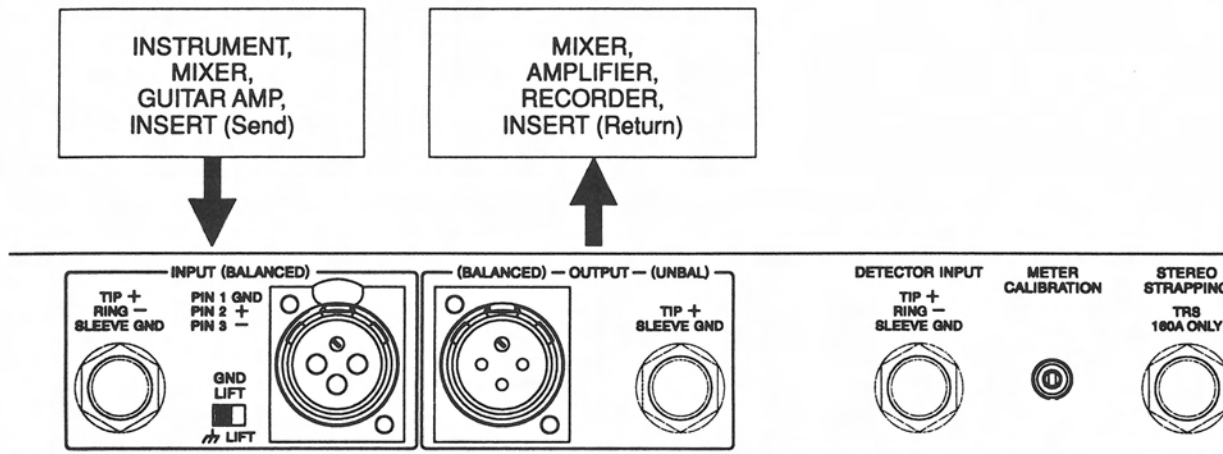

For all connections, refer to the following steps:



1. Turn Off all equipment before making any connections.
2. Mount the 160A in a 1U rack space (optional).

The 160A requires one rack space (height) and 1 rack space (width). It can be mounted above or below anything that doesn't generate heat, since it requires no special ventilation. Ambient temperatures should not exceed 113°F (45°C) when equipment is powered.

**Note:** Avoid over-tightening of rackmounting screws as this could damage the front panel.



**Caution:** Never remove the cover. There are no user-serviceable parts inside, and you run the risk of an electric shock.

3. Make connections via XLR or 1/4" TRS jacks according to your requirements.

Typical patch points include: a mixer's channel or subgroup inserts when using the 160A on individual instruments or tracks; the mixer's main outputs or bus inserts when mixing; an instrument preamp's effects loop when using the 160A for guitar or bass; main outs of a submixer (e.g., keyboard mixer) as the signal is sent to main mixer; between a DAT's output and an analog cassette input. When using a chain of processors, the 160A may be placed either before or after effects or dynamic processors. However, if you are using the 160A for speaker protection, the compressor should be *as close to the amplifier as possible* in the signal chain. We recommend you use common sense and experiment with different setups to see which one provides the best results for your needs.

4. Power On the unit: Securely connect the AC power cord to the unit and mains power.

**Note:** Check the line voltage. The unit is shipped for 115V or 230V, 50 or 60Hz operation. Refer to the unit's rear panel to verify your unit's precise line voltage.

### Multi-Channel (Stereo) Connections

Two channels of program material do not necessarily constitute a stereo program. A stereo program is one where the two channels are recorded and/or mixed to create the illusion of a single unified "panorama" of sound. The stability of the psychoacoustic "image" of each sound source within the stereo program depends upon its ability to maintain a specific phase and amplitude relationship from left to right channel.

If two independent compressors are used to process the stereo program, a loud sound occurring in one channel will cause the image to shift to the opposite side. This can be avoided by linking the two compressors in such a way that both channels receive the same amount of compression.

Stereo operation between two 160As can be accomplished by first "strapping" the two units together, i.e., by connecting the rear panel STEREO STRAPPING jacks of each unit with a 1/4" TRS phone cable. Then, designate one of the two units to be a "Master" (SLAVE button Out) and switch the other unit to "Slave" mode (SLAVE button In, SLAVE LED On).

The Master 160A will now respond to the combined inputs of the 160As. The Master's controls will adjust the amount and nature of the compression and the Slave will track accurately to preserve proper stereo imaging.

**Note:** Remove the strapping cable if you want to use two 160As independently. When the SLAVE buttons on two strapped units are not depressed, the 160As do not operate independently because the "ring" of the strapping cable still sums the audio of each unit. The strapping cable must be removed for proper single-channel operation. If both SLAVE buttons are depressed, both units will be bypassed (i.e., fixed at unity gain).

**Note:** A 160A unit cannot be strapped with a dbx 160XT, 160X, 160, 161 or 162 unit.

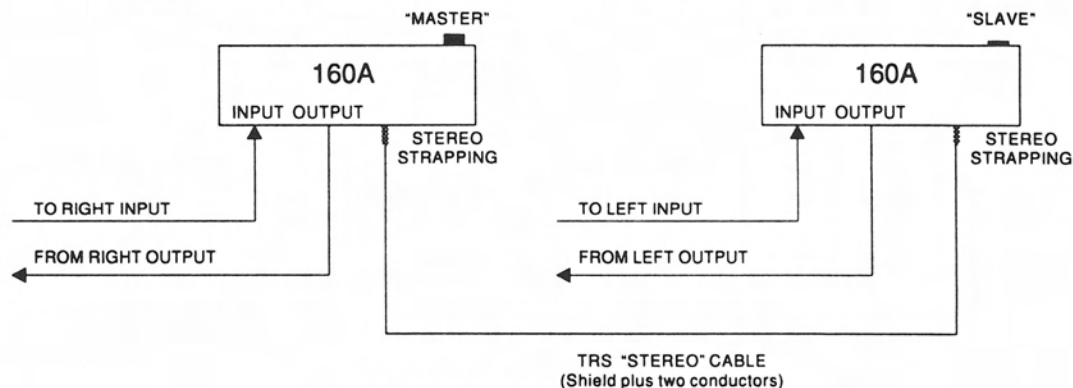

Figure 6: Multi-Channel Connections

### Using External Level Detector Inputs

To control the compressor by signals other than the audio input (via an auxiliary device), connect the auxiliary device's output to the 160A's DETECTOR INPUT jack, and feed the auxiliary device's input with the same signal fed to the 160A's INPUT (Figures 4 and 5). This requires a Y-adaptor, unless the input signal has already been split (e.g., some synthesizers can send the same signal to two outputs).

In certain situations, the auxiliary device may need to be inserted in the signal path, not in the detector path. In such cases, signal is fed to the input of that device, and also to the DETECTOR INPUT, and the auxiliary device's output is fed to the 160A INPUT (e.g., using a delay line to create "negative" attack times).

### Specific System Connections

The 160A has balanced inputs and outputs, and can be used with any line-level device. Some common examples include: mixing consoles, musical instruments, patch bays, and other signal processors.

#### Mixing Board

If you wish to compress a particular track of a multitrack recording or one channel of a live performance, connect the 160A INPUT to the audio source's output jack while the 160A OUTPUT can be directly connected to a line input jack (balanced or not) or the 160A's INPUT and OUTPUT can be wired to an Insert point. In the latter case, the signals will most likely be unbalanced.

**Note:** The amount of compression is directly related to the level of the input signal. However, depending upon your system's setup, it may not always be crystal clear as to what volume controls in your chain affect input level and which affect output level. If the 160A, in relation to your mixer channel's volume controls, is "pre-fader" (i.e., the 160A is connected to mixer inserts so that the compression effect occurs before the mixer channel's volume fader), you can boost or cut the input level by adjusting the source's volume control (e.g., a synthesizer's volume control) and boost the track's output level using the 160A's OUTPUT GAIN control or the mixer's volume fader (the latter here is great for track fade-outs). If the 160A, is "post fader" (i.e., the 160A is connected to mixer inserts so that the compression effect occurs after the level set by the mixer channel's volume fader), adjusting the mixer's volume fader changes the input level and the amount of compression. If you would rather have this volume fader control output, we suggest you set up the compressor directly between the source and the mixer channel's input. This way, you can use the instrument's volume control to define the input level and amount of compression and the mixer's volume fader to change only the overall volume of the track.

#### Musical Instruments (e.g., Electric Guitar, Bass, Keyboards, Electric-Acoustic Instruments)

The output of an electric guitar is sometimes not "hot" enough to drive the 160A's INPUT. When this is the case, you should use the "PREAMP OUT" of your guitar amp (if so equipped), or the output of some other device that is designed to accept low-level instrument inputs (including various foot pedal effects, acoustic pickup preamps, and rack mount audio products, like the dbx 163X, 263X, and 563X). Such sources can be balanced or unbalanced — this is no problem for the 160A.

Microphones, bass guitars, and electric-acoustic instruments, also typically have low-level outputs. With most setups they require signal boost to drive the 160A's INPUT. For example, when recording voice directly to a portable tape deck, a mic preamp (like the dbx 760X) placed between the mic and the 160A (which is then fed to one of the recorder's inputs) can boost the signal for the 160A as well as provide a high level signal to the tape deck.

Keyboards, samplers, drum machines and sound modules typically produce a line-level signal and can be connected directly from the instrument's output to the 160A's INPUT.



**Note:** DO NOT CONNECT the output of a power amp or the speaker out of an instrument to the input of the 160A. Severe damage to system components may result.

#### Patch Bay

In the studio, the 160A may be connected to a patch bay to allow it to be used anywhere in the studio system. If your studio is not fully balanced, you *must* ground the unused XLR pin (either pin 2 or 3) or use the 1/4" phone jack OUTPUT, which is single-ended. Another option is to have a qualified technician install an optional output transformer, which will require grounding of either pin 2 or 3 of the XLR-type OUTPUT.

#### Sound Reinforcement

To compress a live mix or to protect loudspeakers, connect the 160A between the source (mixing board or distribution amp) and the power amp(s). If multi-way loudspeakers with low-level electronic crossovers are used, the 160A(s) should go after the crossover(s). For a stereo system, you can separately stereo couple the two high band crossovers, low band crossovers, etc. (see page 11). If limitations require that you use a single 160A before a crossover, adding an equalizer to the side chain may provide some additional protection to your high frequency components (see "Speaker Protection," page 7).



## INSTALLATION CONSIDERATIONS

### Input/Output Cable Configurations

#### Hookups and Cabling

The 160A is a 600Ω, balanced (differential) unit designed for nominal +4dBu levels; inputs and outputs are tip/ring/sleeve phone jacks and XLR-type jacks. The 160A can be used with either balanced or unbalanced sources and outputs can be used with either balanced or unbalanced loads, provided you use proper cabling.

A balanced line is defined as two-conductor shielded cable with the two center conductors carrying the same signal but of opposite polarity with respect to ground. An unbalanced line is generally a single-conductor shielded cable with the center conductor carrying the signal and the shield at ground potential.

#### Input Cable Configurations

The 160A has an actual input impedance of >40kΩ in balanced or unbalanced configurations. This makes the 160A audio input suitable for use with virtually any source impedance, low or high. The 160A's input jacks are wired in parallel. That is, the phone jack TIP (+) connection is internally wired to the XLR-type pin 2, the RING (-) is wired to pin 3, and the SLEEVE (shield) is wired to pin 1. Note that pins 2 and 3 are the reverse of certain older dbx and other manufacturer's equipment, but if the same connection is used at both the input and the output, the signal will be correctly polarized ("in phase").

Reversing the input wires to the input terminals will result in the output signal polarity being the opposite of the input signal ("180° out of phase").

#### Output Cable Considerations

The model 160A has two separate outputs: one single-ended amplifier driving the 1/4" stereo phone jack, and a separate active-balanced amplifier driving the XLR-type OUTPUT jack. Each is capable of driving a 600Ω load to +24dBu.

#### Grounding

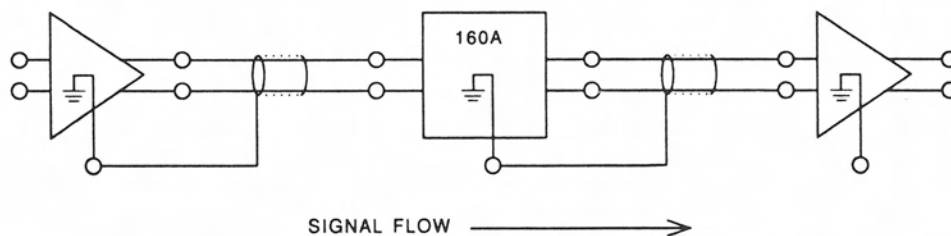

Figure 7: Signal Flow (Balanced Connection)

For maximum hum rejection with a balanced source, avoid common grounding at the 160A's input and output. Most balanced (3-conductor) cables have the shield connected at both ends. This can result in ground loops which cause hum. If hum is a problem, try changing the position of the rear panel GROUND LIFT switch. This switch disconnects the input XLR-type pin 1 (the shield) from the 160A's chassis ground. We advise starting with the switch in the LIFT position (shield disconnected at the 160A input). If hum persists try disconnecting the shield on one or more of your cables, preferably at the input of a device, not at the output: Ground the shield of the input cable at the source device (leaving it unconnected at the 160A's INPUT) and ground the shield of the output cable to the ground terminal of the 160A (leaving it unconnected at the receiving device). The shield is pin 1 on the XLR, SLEEVE on a 1/4" TRS.

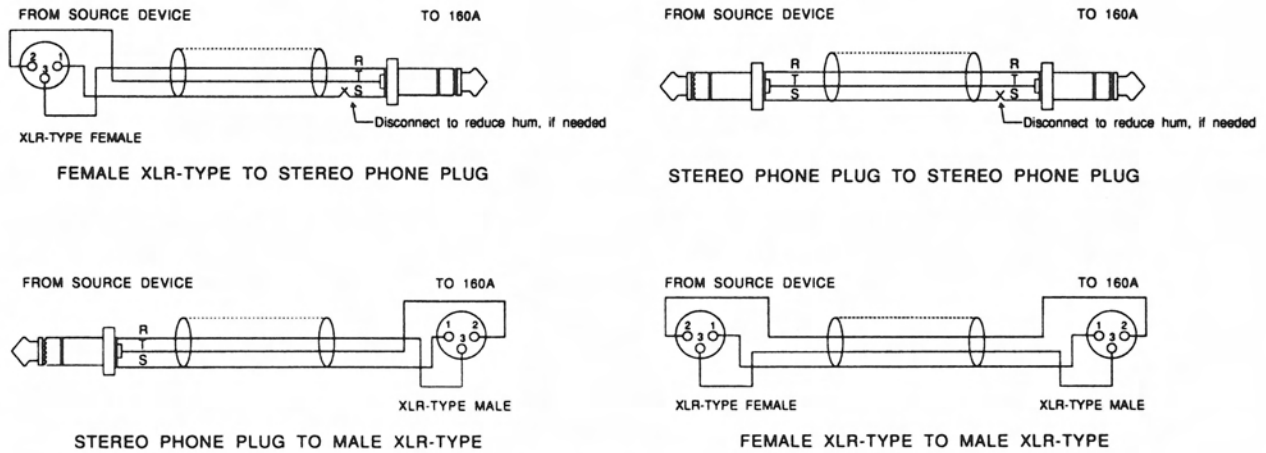

Figure 8: Input Connections (Fully Balanced Operation)

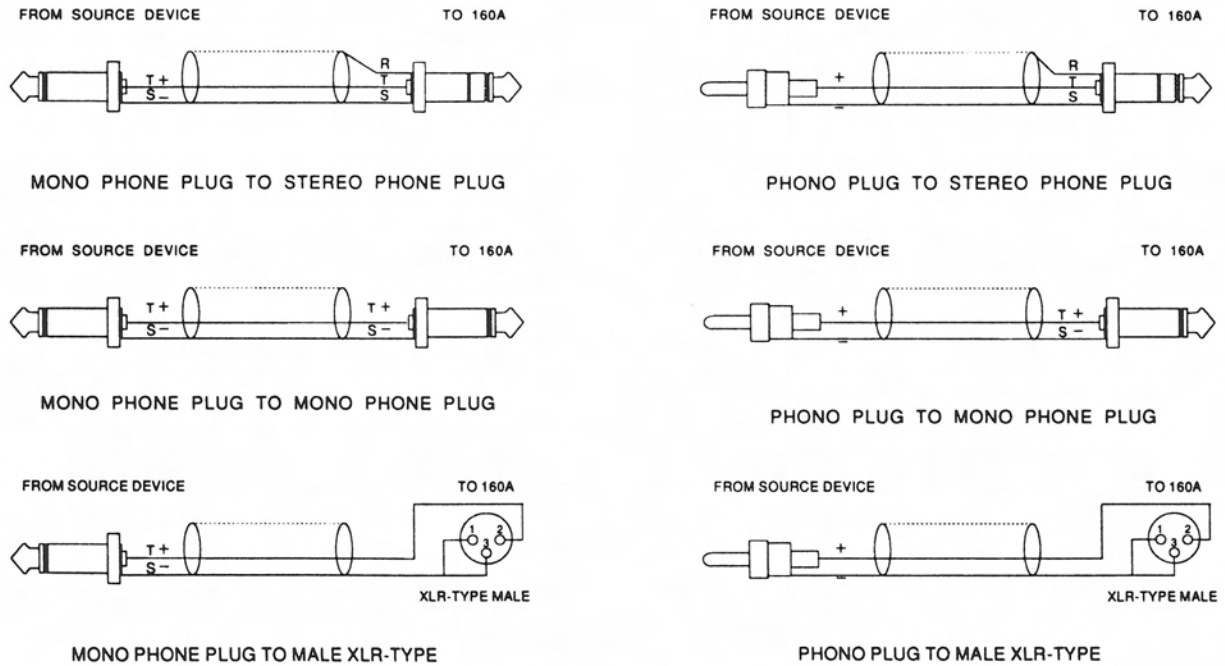

Figure 9: Input Connections (Unbalanced Operation)

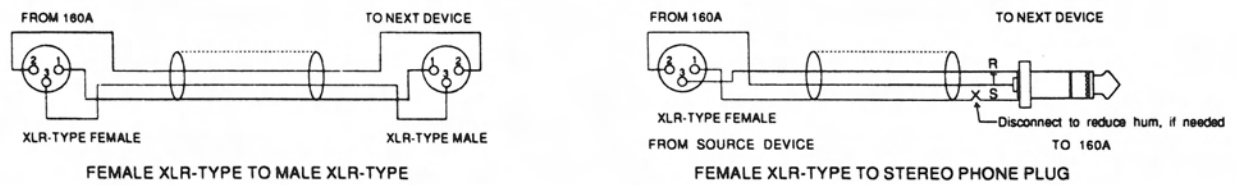
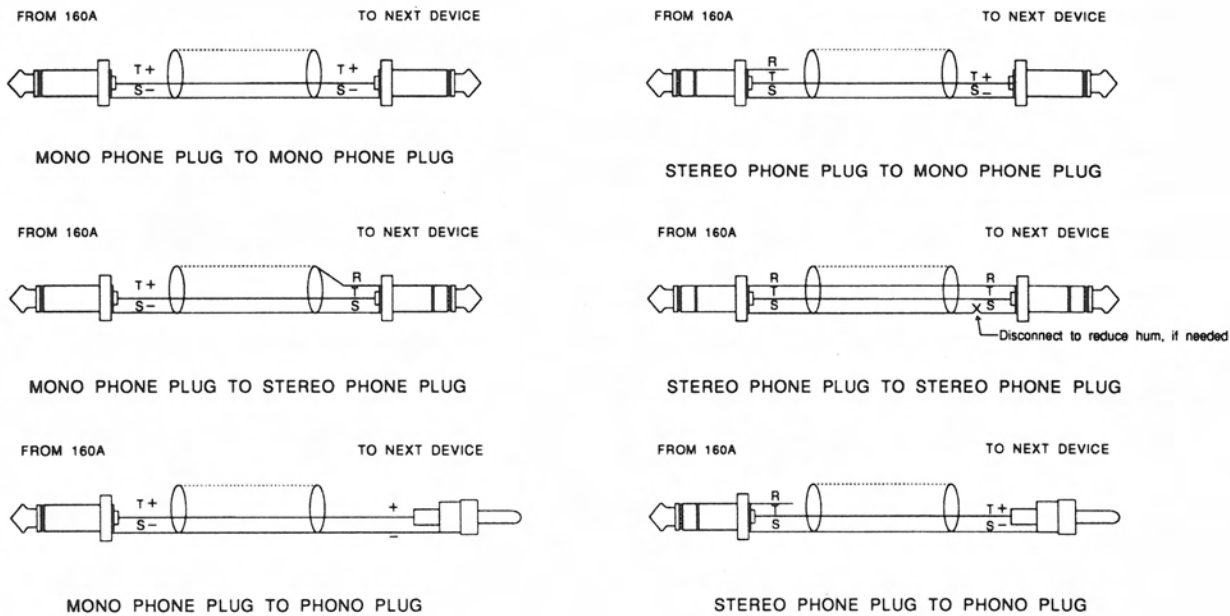

Figure 10: Output Connections (Fully Balanced Operation)



**Figure 11: Output Connections (Unbalanced Operation)**

## TECHNICAL SUPPORT, FACTORY SERVICE

### Technical Support/Factory Service

The 160A is an all-solid-state product with components chosen for high performance and excellent reliability. Each 160A is designed, assembled, tested, burned in and calibrated at the factory in the USA and should require no internal adjustment of any type throughout the life of the unit. We recommend that your 160A be returned to the factory only after referring to the manual and consulting with Customer Service.

Our phone number, fax number and address are listed on the inside front cover. When you contact dbx Customer Service, be prepared to accurately describe the problem. Know the serial number of your unit — this is printed on a sticker attached to the rear panel.

**Note:** Please refer to the terms of your Limited Two-Year Standard Warranty, which extends to the first end-user. After the warranty expires, a reasonable charge will be made for parts, labor, and packing if you choose to use the factory service facility. In all cases, you are responsible for transportation charges to the factory. dbx will pay return shipping if the unit is still under warranty.

**Shipping Instructions:** Use the original packing material if it is available. Mark the package with the name of the shipper, and with the following words in quotes in red: "DELICATE INSTRUMENT, FRAGILE!" Insure the package properly. Ship prepaid, not collect. Do not ship parcel post. (If you do not plan to save the packaging material, please recycle it.)

### Registration Card and User Feedback

We appreciate your feedback. After you have an opportunity to use your new 160A, please complete the Registration Card (located in back of this manual), detach it from the manual and return it.



## SPECIFICATIONS

<b>Input (1/4" TRS Phone and XLR)</b> <b>Impedance</b> <b>Maximum Level</b> <b>CMRR</b> <b>Detector Input (1/4" TRS Phone)</b> <b>Impedance</b> <b>Maximum Level</b>	Floating Balanced; XLR: Pin 2 Hot, Phono: Tip Hot >40k $\Omega$ +24dBu, Balanced or Unbalanced (Absolute) >45dB (Any Frequency) Floating Balanced >200k $\Omega$ +28dBu, Balanced or Unbalanced
<b>Output (XLR)</b> <b>Impedance</b> <b>Maximum Level (Balanced)</b> <b>Maximum Level (Unbalanced)</b> <b>Noise</b> <b>Frequency Response</b> <b>THD</b>	Floating Balanced; Pin 2 Hot 30 $\Omega$ +24dBm; <0.3% THD +20dBm; <0.3% THD <-90dBu, Unweighted (20Hz - 20kHz) 20Hz - 20kHz, +0, -0.5dB; +0, -3dB 0.5Hz and 90kHz <0.2%, Typical, Any Amount of Compression up to 40dB @ 1kHz
<b>Output (1/4" TRS Phone)</b> <b>Balancing</b> <b>Impedance</b> <b>Maximum Level</b>	Unbalanced 20 $\Omega$ +24dBm
<b>Dynamic Range</b>	>113dB
<b>Gain Adjustment Range</b>	Variable from -20dB to +20dB
<b>Threshold Range</b> <b>Threshold Characteristic</b>	-40dBu to +20dBu Selectable OverEasy <sup>®</sup> or Hard Knee
<b>Compression Ratio</b>	Variable 1:1 to $\infty$ :1 thru to -1:1; >60dB Maximum Compression
<b>Attack Time</b>	Program-Dependent; Typically 15ms for 10dB, 5ms for 20dB, 3ms for 30dB
<b>Release Time</b>	Program-Dependent; Typically 8ms for 1dB, 80ms for 10dB, 400ms for 50dB; 125dB/Sec Rate
<b>Stereo Coupling</b>	True Power Summing; 1/4" TRS Phone Jack
<b>Power Cord</b> <b>Operating Voltage</b> <b>Operating Temperature</b>	IEC-Type Connector DO: 90 - 130VAC, 50/60Hz; EU: 200 - 250VAC, 50/60Hz 0°C to 45°C (32°F to 113°F)
<b>Dimensions (H x W x D)</b> <b>Rack Space</b> <b>Weight</b>	1.75" x 19" x 6.5" (4.45cm x 48.2cm x 16.51cm) 1 Rack Unit (1U High) Net Weight: 4.415 lbs (1.99 kg). Shipping Weight: 6.62 lbs (2.99 kg).

**Notes:** Noise and frequency response specifications are at unity gain.  
 0dBV = 1.0VRMS; 0dBu = 0.775VRMS.

Specifications are subject to change.

## SCHEMATICS

Schematics for the 160A Main Board and Display and Power Supply are provided on the following pages. The Final Assembly Drawing is also included.

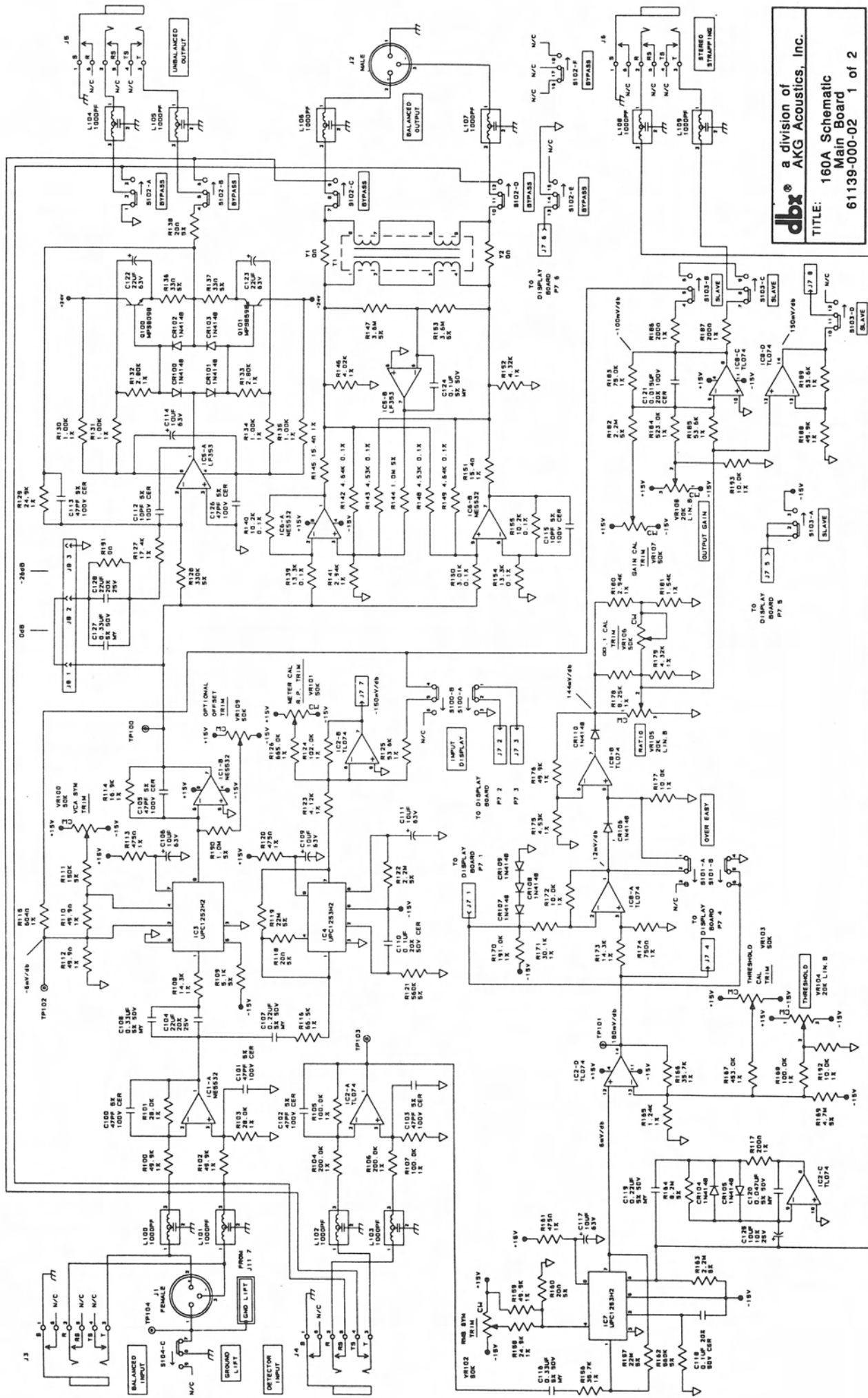

**dbx** a division of  
**AKG Acoustics, Inc.**  
 TITLE: 160A Schematic  
 Main Board  
 61139-000-02 1 of 2

SPARES

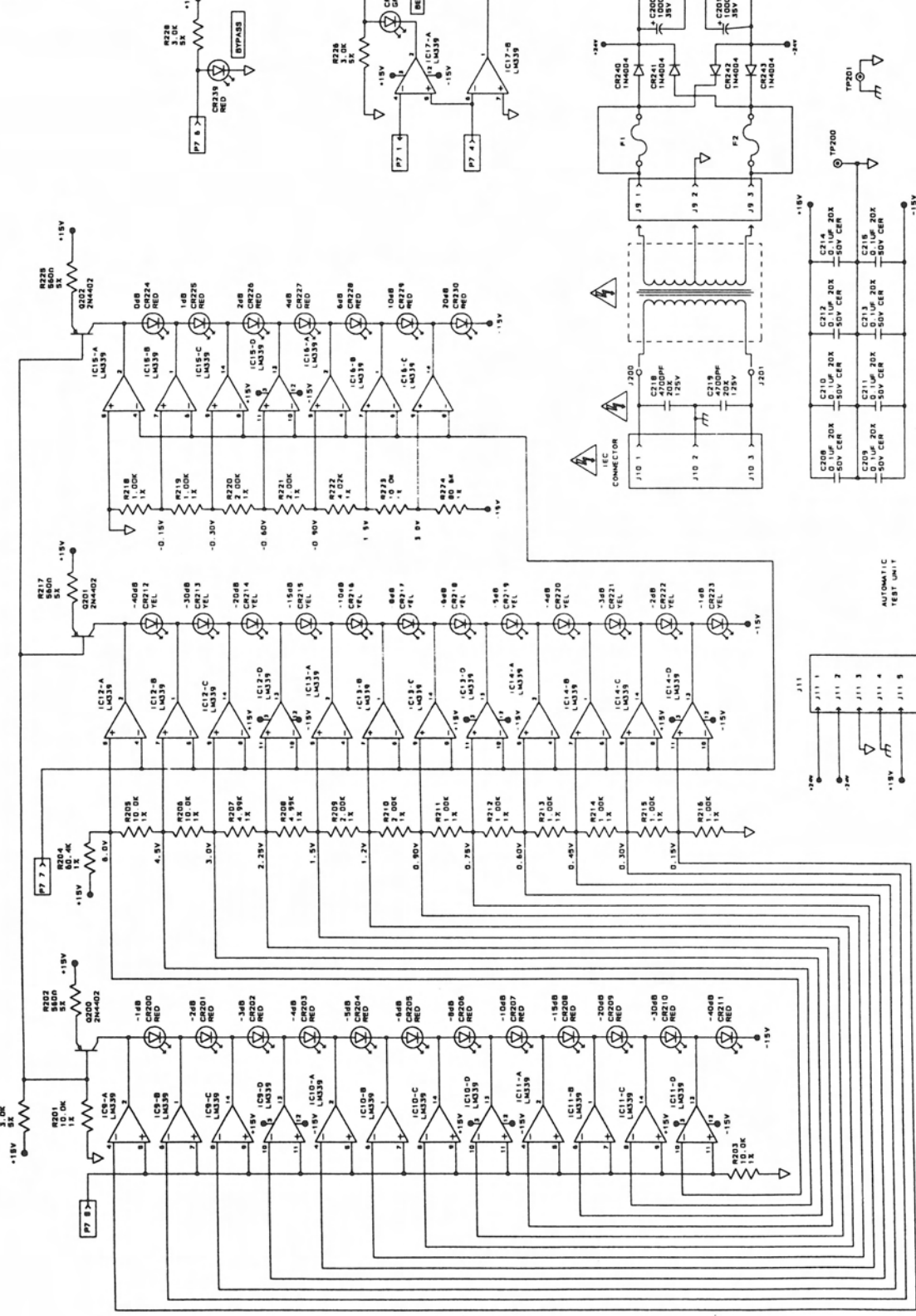
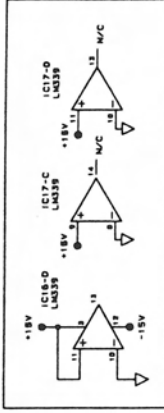

**dbx** a division of  
AKG Acoustics, Inc.

TITLE: 160A Schematic  
Display and Power  
61139-000-02 2 of 2

CAUTION: RISK OF ELECTRIC SHOCK  
AVOID CONTACT WITH LIVE PARTS

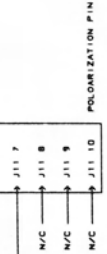
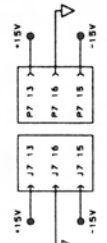



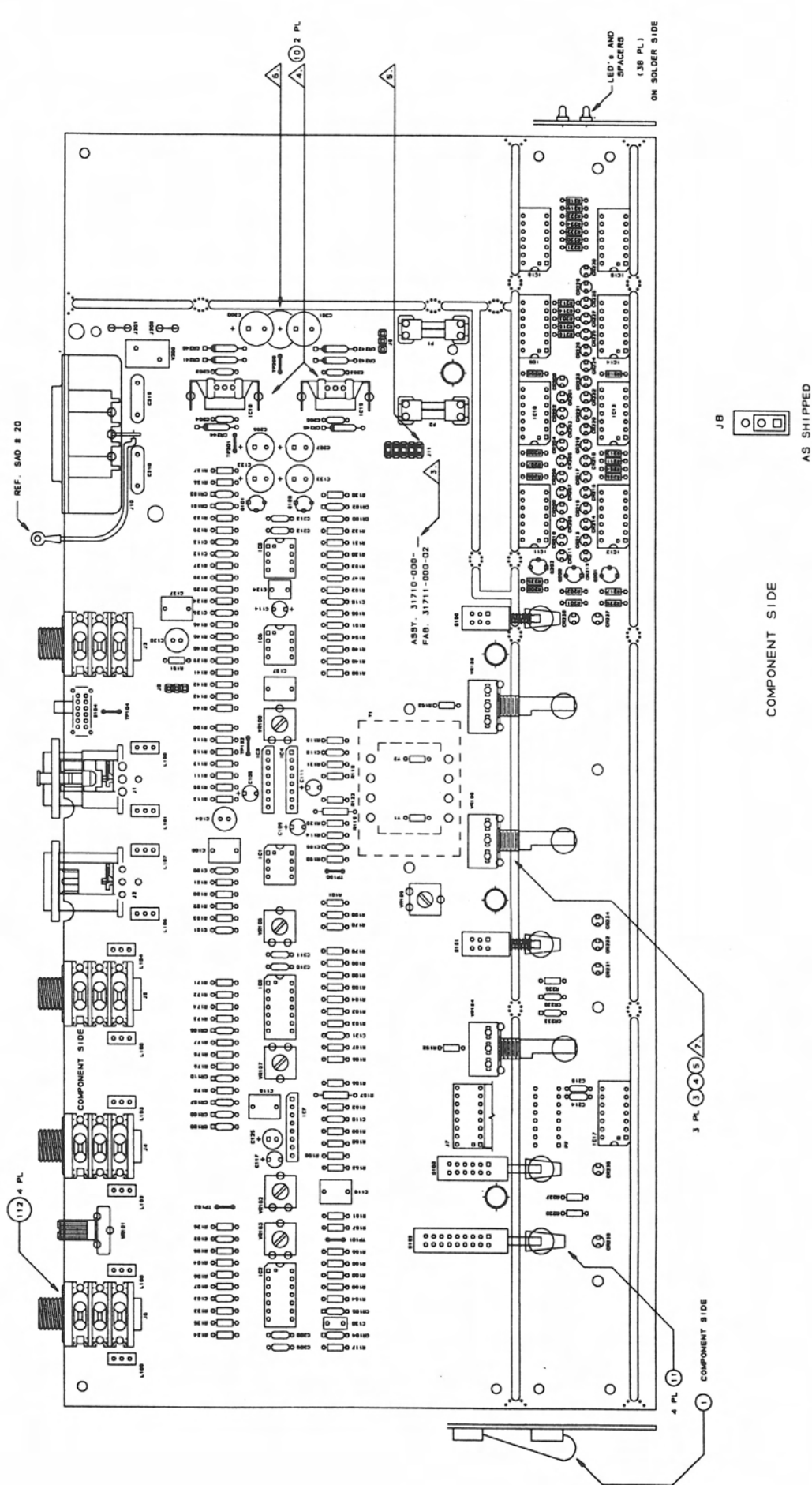

**dbx** a division of  
 AKG Acoustics, Inc.  
 TITLE: 160A  
 Final Assembly  
 06071-000-01 1 of 1

1. ADD POT MOUNTING HARDWARE  
 2. SECURE C1 & C2 TO PCB WITH GLUE  
 3. CLIP PIN 10 OF J1  
 4. ADD HEATSINK  
 5. MARK ASSEMBLY REVISION LEVEL IN SPACE PROVIDED  
 6. SQUARE PADS INDICATE PIN 1 OF CONNECTORS. CATHODE OF DIODES POS. SIDE OF CAPS. PIN 1 OF IC'S
- NOTES: (UNLESS OTHERWISE SPECIFIED)

COMPONENT SIDE

COMPONENT SIDE

AS SHIPPED

JB

LED'S AND SPACERS  
(3.8 PL.)  
ON SOLDER SIDE

ASSEMBLY FAB. 31710-000-02  
31711-000-02

REF. SAO 8 20

112 4 PL

4 PL 11

COMPONENT SIDE

3 PL 3 4 5 7

## NOTES

---



# WARRANTY

## United States Warranty

### Limited Warranty

This warranty is valid only for the original purchaser and only in the United States. We warrant dbx products against defects in material or workmanship for a period of two years from the date of original purchase for use, and agree to repair or, at our option, replace any defective item, except external power transformers, without charge for either parts or labor.

**IMPORTANT:** This warranty does not cover damage resulting from accident, misuse or abuse, lack of reasonable care, the affixing of any attachment not provided with the product, loss of parts, or connecting the product to any but the specified receptacles. This warranty is void unless service or repairs are performed by an authorized service center. No responsibility is assumed for any special, incidental or consequential damages. However, the limitation of any right or remedy shall not be effective where such is prohibited or restricted by law.

Simply take or ship your dbx product prepaid to our service department. Be sure to include your sales slip as proof of purchase date. (We will not repair transit damage under the no-charge terms of this warranty.) dbx will pay return shipping.

**NOTE:** No other warranty, written or oral is authorized for dbx products.

This warranty gives you specific legal rights, and you may also have other rights which vary from state to state. Some states do not allow the exclusion of limitations of incidental or consequential damages or limitations on how long an implied warranty lasts, so the above exclusion and limitations may not apply to you.

## International Warranty

### Bedingungen

dbx gewährt 2 Jahre Garantie ab Verkaufsdatum auf nachweisbare Material- und Fabrikationsfehler (ausgenommen externe Netzgeräte). Der Garantieanspruch erlischt bei unsachgemäßer Handhabung, elektrischer oder mechanischer Beschädigung durch mißbräuchliche Anwendung sowie bei unsachgemäßer Reparatur durch nichtautorisierte Werkstätten. Zur Inanspruchnahme der angeführten Garantieleistung ist der Nachweis da Kaufes (ordentliche Rechnung da Verkäufers erforderlich). Transport- und Portospesen, welche aus der Einsendung des Gerätes zur Garantiereparatur erwachsen, können von dbx nicht übernommen werden, das Risiko der Zusendung trägt der Kunde. Die Garantie wird ausschließlich für den ursprünglichen Käufer geleistet.

### Warranty Conditions

dbx warrants dbx products (except for external power transformers) against evident defects in material and workmanship for a period of two years from the date of original purchase for use. This warranty does not cover damage resulting from misuse or abuse, or lack of reasonable care, and inadequate repairs performed by unauthorized service centers. Performance of repairs or replacements under this warranty is subject to proof of purchase. Shipment of the defective item for repair under this warranty will be at the customer's own risk and expense. This warranty is valid for the original purchaser only.

### Conditions de garantie

Pour toute mise en œuvre de garantie ou de service après-vente, vous devez vous adresser à votre revendeur. Notre société assure au revendeur le remplacement gratuit des pièces détachées nécessaires à la réparation pendant deux ans, à partir de la date de votre facture, sauf en cas de non respect des prescriptions d'utilisation ou lorsqu'une cause étrangère à l'appareil est responsable de la défaillance. Cette garantie n'est pas appliquée pour les transformateurs externes. Les dispositions stipulées ci-dessus ne sont pas exclusives du bénéfice au profit de l'acheteur de la garantie légale pour défaut et vice cachés qui s'applique, en tout état de cause, dans les conditions des articles 1641 et suivants du Code Civil.

### Condizioni di garanzia

L'dbx presta garanzia per due anni dalla data della vendita per difetti di materiale e fabbricazione che possono essere provati. Il diritto di garanzia cessa in caso di manipolazione impropria, danneggiamento elettrico o meccanico attraverso l'uso non appropriato e riparazione inesperta eseguita da officine non autorizzate. E' indispensabile, per la prestazione della garanzia, presentare la carta di garanzia debitamente riempita dal rivenditore autorizzato e la fattura di vendita. Spese di trasporto che risultano dall'invio dell'impianto per la riparazione in garanzia, non possono essere assunte dall'dbx l'invio è a rischio e pericolo del cliente. La garanzia verrà data solo al primo acquirente.

### Condiciones de garantía

dbx concede dos años de garantía (menos fuentes de poder exteriores) por defectos comprobables de material o de fabricación a partir de la fecha de venta. El derecho de garantía caduca en caso de procederse a una manipulación inadecuada en caso de producirse daño eléctrico o mecánico por uso indebido, así como también en caso de reparaciones inadecuadas por parte de talleres no autorizados. La prestación de la garantía está sujeta a la presentación de la factura de compra. dbx no asume ningún gasto de transporte o correo incurrido por el envío del aparato defectuoso para la reparación bajo garantía; el riesgo del envío ha de ser asumido por el cliente. La garantía se concede única y exclusivamente al comprador original.



The first part of the document discusses the importance of maintaining accurate records of all transactions. It emphasizes that every entry, no matter how small, should be recorded to ensure the integrity of the financial statements. This includes not only sales and purchases but also expenses, income, and any other financial activity.

The second part of the document provides a detailed breakdown of the accounting process. It starts with the identification of the accounting cycle, which consists of eight steps: identifying the accounting cycle, analyzing and journalizing the transactions, posting to the ledger, determining the debit and credit balances, preparing a trial balance, adjusting the entries, preparing financial statements, and closing the books.

The third part of the document discusses the various types of accounts used in accounting. It categorizes them into assets, liabilities, equity, revenue, and expense accounts. Each type of account has a specific format and is used to record different types of transactions.

The fourth part of the document discusses the importance of the trial balance. It explains that the trial balance is a statement that lists all the accounts and their balances at the end of an accounting period. It is used to check the accuracy of the accounting records and to ensure that the debits equal the credits.

The fifth part of the document discusses the various financial statements that are prepared from the accounting records. These include the balance sheet, the income statement, the statement of owner's equity, and the statement of cash flows. Each statement provides different information about the financial performance and position of the business.

The sixth part of the document discusses the importance of closing the books at the end of each accounting period. It explains that closing the books involves transferring the balances of the temporary accounts (revenue, expense, and owner's drawing) to the permanent accounts (assets, liabilities, and equity) to prepare for the next period.

The seventh part of the document discusses the various methods used to record transactions. It includes the double-entry system, which is the most common method, and the single-entry system, which is simpler but less accurate.

The eighth part of the document discusses the various types of errors that can occur in accounting. These include errors of omission, errors of commission, errors of principle, and errors of calculation. It provides tips on how to identify and correct these errors.

The ninth part of the document discusses the various types of accounts that are used in accounting. It includes the asset accounts, liability accounts, equity accounts, revenue accounts, and expense accounts. It also discusses the various types of journals and ledgers that are used to record transactions.

The tenth part of the document discusses the various types of financial statements that are prepared from the accounting records. It includes the balance sheet, the income statement, the statement of owner's equity, and the statement of cash flows. It also discusses the various types of ratios and percentages that are used to analyze the financial performance of the business.