

## **Behringer Ultramatch PRO SRC2496 60687**

### **Upsampling - is it good or bad ?**

### **Have I found the best DAC in the World ? I can assure you - I am DAMN CLOSE !**

february 2009

I must admit, that I don't know digital technology well enough to dive deep into explanations about upsampling.

So it must be for the time being enough to say, that the SPDIF signal is converted from 44,1 kHz to higher frequencies (96 kHz) and higher bitrate (24) so it "looks" like DVD or SACD signal. So DACs which are capable of converting such high resolution signals - are working in different conditions - at the upper limits of their capabilities.

I was offered to test the funny machine - the famous Behringer Ultramatch Pro- a box made for the pro audio industry , which can convert and manipulate any digital signal to any other.

Among 100 other functions - Behringer can simply upsample the straight S/PDIF into 96kHz/24 Bit.

The box is simply placed in series with the S/PDIF cable - between the transport and the DAC.

I connected it in my system between my Philips Fikus Transport and two DACS which I had at hand - the lampized Buffalo Sabre32 and Wolfson WM8742.

Normally - I hate devices which add complexity and add manipulation to the sound. I believe in less is better.

BUT  
This device is different, Unlike oversampling - which we already know is VERY bad for music - upsampling may be sometimes VERY GOOD. It is not the panacea, universal Hi-Fi cure, but in my system, very revealing and transparent - I tell you as it was. YMMV.

I can tell you - after hitting the UPSAMPLE button on the Behringer - I was taken to heaven. The DAC started to behave like a magic box.

The normal signal, the normal sound - was taken to another level.

Something extraordinary happened. I have big problems putting it in words, especially English.

Music becomes smooth, liquid, magical. The same music which sounded just great without Behringer - with the process of upsampling sends the chill up my spine.

Whhhooooa! Now this is another experience - this is high end. I CAN'T POSSIBLY GO BACK TO NAKED DAC. The whole thing is about the PLEASURE of listening. It increases much.

Now - the price context - we are not talking 100 000 Euro like for Goldmund heavy CD table. We are talking maximum 150 Euro, or even less. I bought mine for 80 incl vat, brand new with warranty etc..

Yes, for a mere 100 Eu extra - our transport - DAC combo can be improved by a whole level.

I can not guarantee that this will apply to all DACS - your mileage may vary. But if the DAC is a 96 kHz/24Bit compatible - the Behringer will be your best spent 100Eu ever.

I am keeping my unit.

Or maybe - I2S - withoutr Behringer will sound even better ? I must check it.

Generally, the studio pro industry seems to have completely different price point calculations than High End. Their product costs the cost of parts and labour plus a margin.

Not "cost plus 10 000 Euro. " The built quality is very good, parts are good, sound is great. Such a honest product that my hats off.

## **Behringer Ultramatch Pro SRC2496**



What I dont like is the amount of LEDs and options on the front - but hey, it is a PRO equipment not home lifestyle. And if it plays well, who gives a shit.



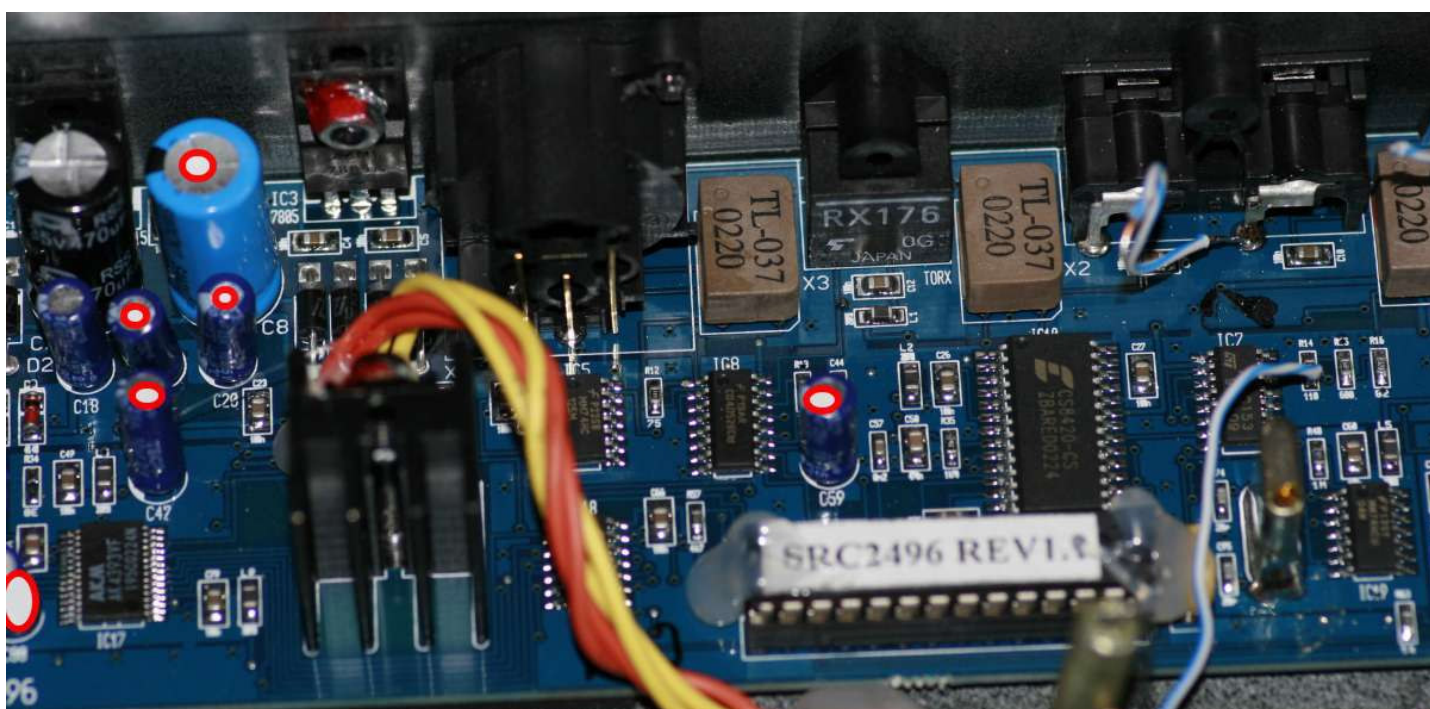

The red circles indicate the caps that can be replaced. Tantalum 10uF/10V are good for the small ones .  
Blackgates are good too.  
Generally - dont use caps bigger than 100uF - and the big blue can be a few thousand uF by minimum 16V.

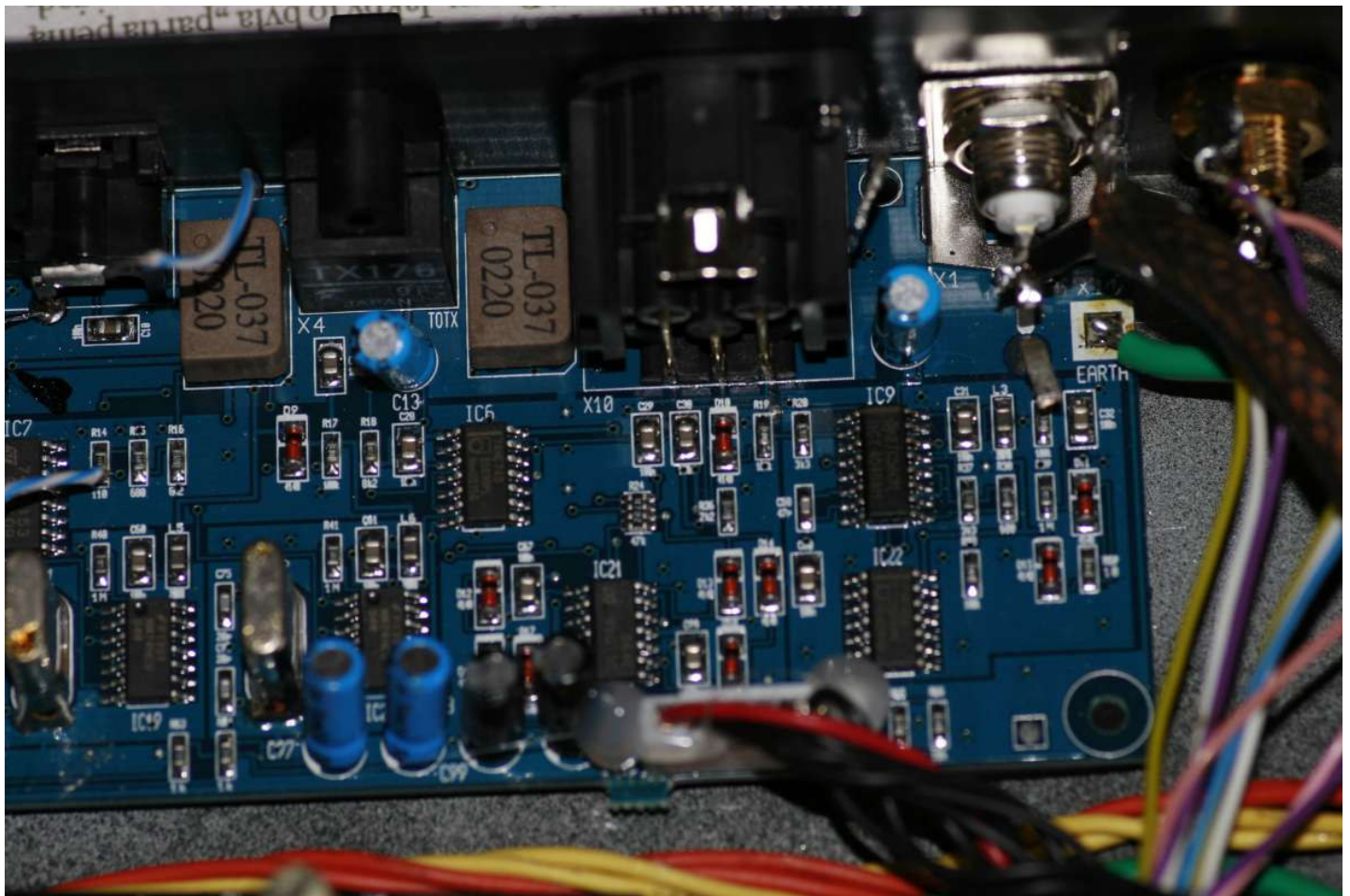

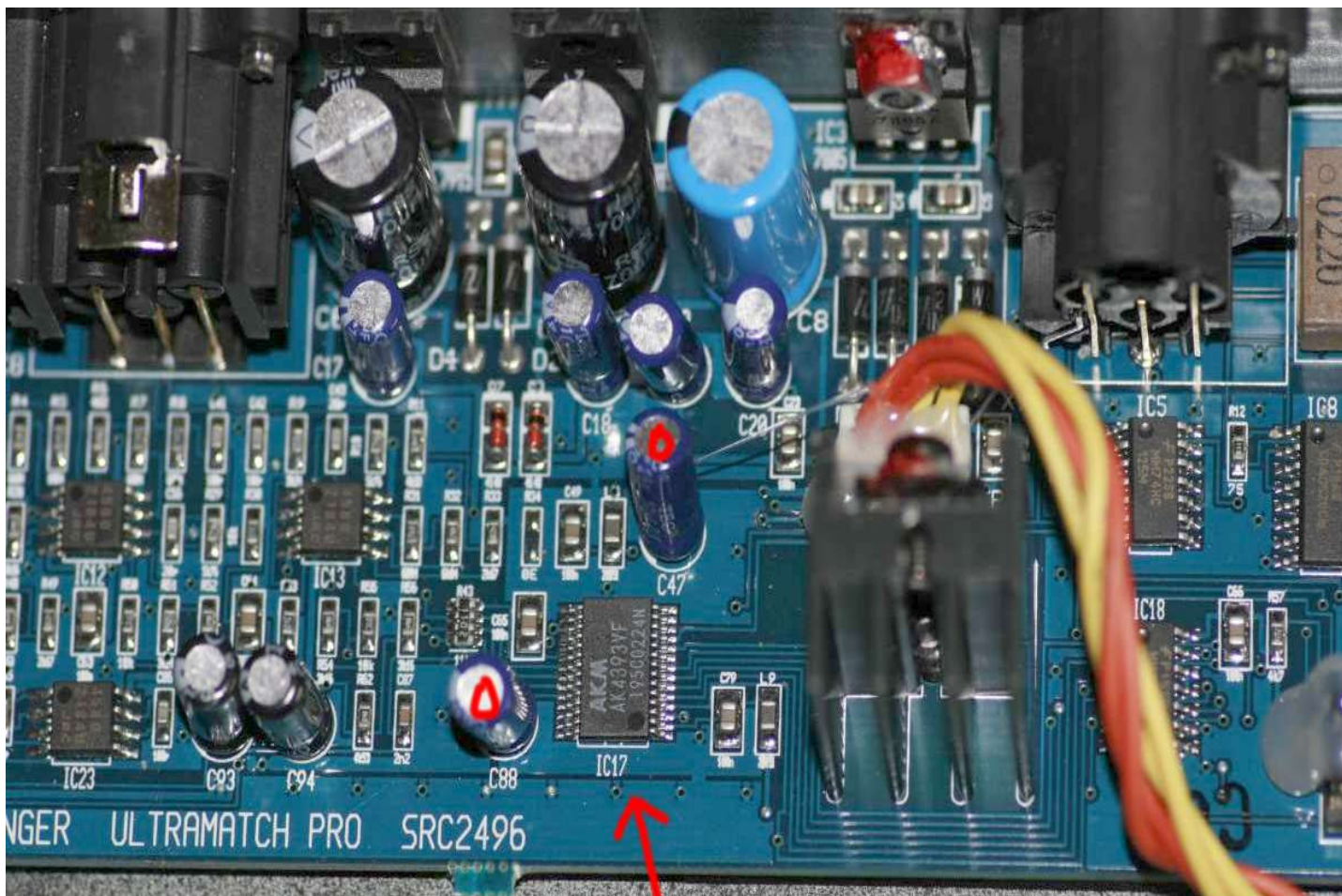

## What else does Behringer Ultramatch Pro do?

Well, I am really impressed. Not only Ultramatch upsamples, not only it accepts AES/EBU signals, Toslink, S/PDIF and outputs all and any of the above. It also has a very good ADC converter for recording analog to digital. It also has a built-in DAC - a superb Japanese chip called AK4393. You can simply add Lampizator to this DAC and you have a high-end DAC with upsampling built in.

You could also upgrade the cheap electrolytic caps to the Oscon, Blackgate, or even SEPC Oscon level. So the sky is the limit on Behringer. I will investigate it further and you make sure you buy one to experiment.

The only downside is the looks - it has a visual design not from my preferred style to put it mildly.

A month later.

I was sitting at home on one sunday afternoon and suddenly an itch occurred, a fire in my fingers - to SOLDER SOMETHING. I did not feel like a long project - so just for the hell of it I grabbed the soldering iron and I put 2 wires from test box Lampizator to the Behringer Ultramatch Pro DAC chip - abovementioned AKM AK4393. (I swear this SMD print is so f\*\*g fine and thin and small that you better ask your friendly eye surgeon to help you with soldering.

Anyway - one - two - three - the behringer is lampized.

I have floated the DAC outputs and soldered them directly to SRPP using Tesla Goldpin E88CC and 200 Ohm resistors in cathodes.

I admit - I was expecting good sound. And it is good. It is damn good. I have direct comparison with the second Behringer working as upsampler only and driving a hot rodded Lampucera with the mighty DAC CS4397 and I am telling ya - The AKM DAC is a little bit better. Even BEFORE cap tuning of Behringer.

AKM DAC (NOT EVEN THEIR TOP MODEL) is equally good as ESS Sabre32 Reference DAC, equally good as Wolfson WM8742 , but the fact that it is DIRECTLY BUILT IN - makes it a winner. The upsampling process applied directly from Behringer on the dac has a clear edge over two unnecessary S/PDIF processes - out of Behringer and into the Lampucera receiver chip. The AKM omits all that and it sits right on the music.

To my ears, the Lampized AKM is a DREAM COME TRUE: the quality is mind-blowing, that's how good it is. We get (okay - an ugly) case with power cable, switch, all power supplies, transformer. display LED, we get all we need except lampizator.

**This device with lampizator installed - becomes my new reference DAC - but of course only with the upsampling function active.**



Above - one VERY good variant of Behringer without tubes. It uses two sowter 9545E transformers instead. They are running from balanced DAC direct outputs into SE secondary. The connection takes 5 minutes and the sowters cost 140 GBP per pair. Together for 200 GBP including a new Behringer we get a stellar performer ! Recommended. On the sound quality scale between the stock opamp stage and the lampizator stage this is 90 % at the lampizator's end.

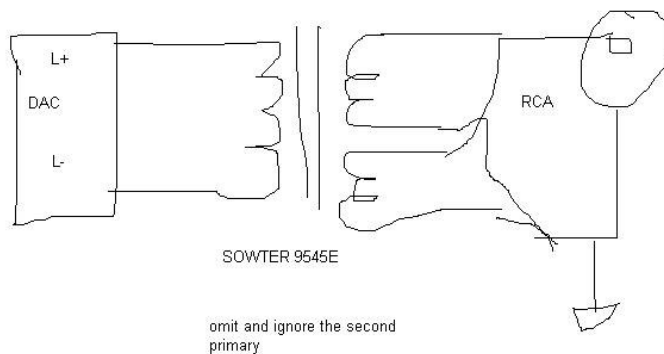

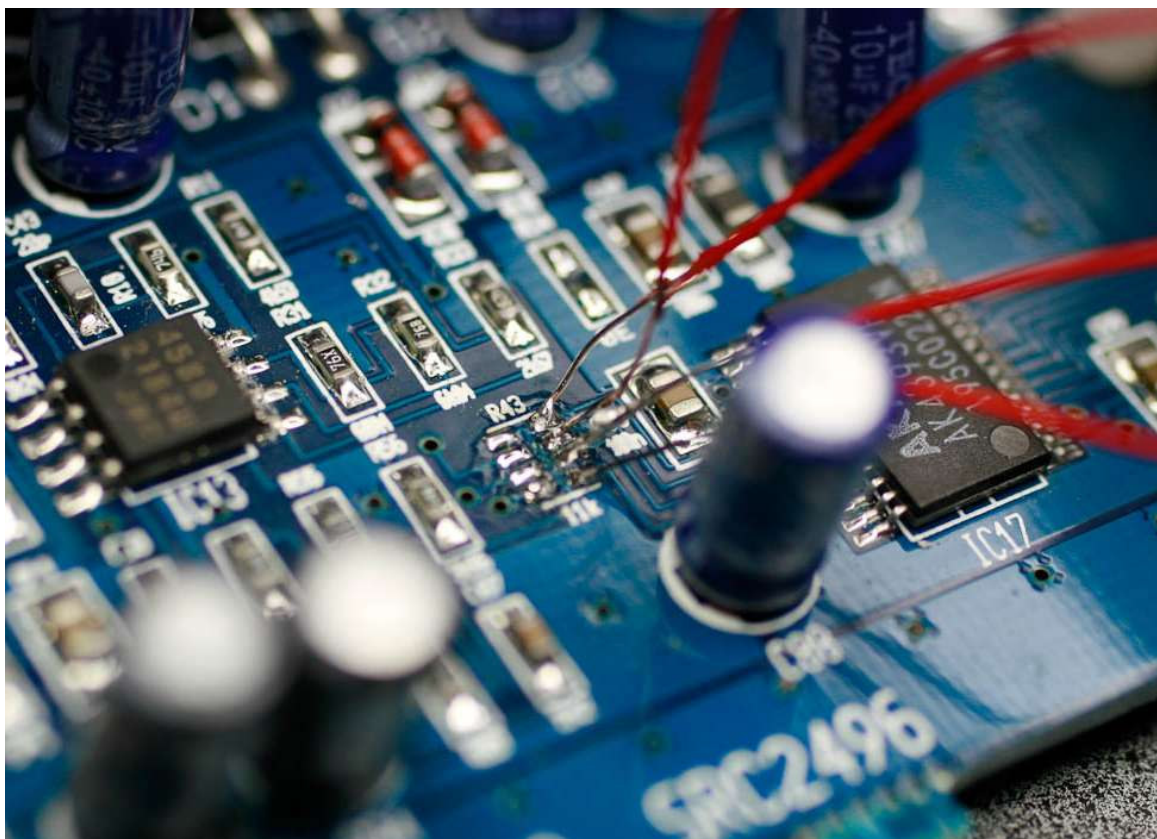

To steal the signal I removed completely the integrated quadrupled R43 resistor 11K. I simply applied on the quadruple resistor a big drop of solder which heated it so much that it fell off. Then I soldered AWG30 silver wires to the soldering spots on the DAC side of those resistors now removed. Counting from top of the photo these are R+, R-, L+ and L- voltage outputs with very small DC offset. I measured only 0,15 V not 2,5 as usual. In fact - I believe they can be connected to tube without any caps in series - just wired directly to tube grids.

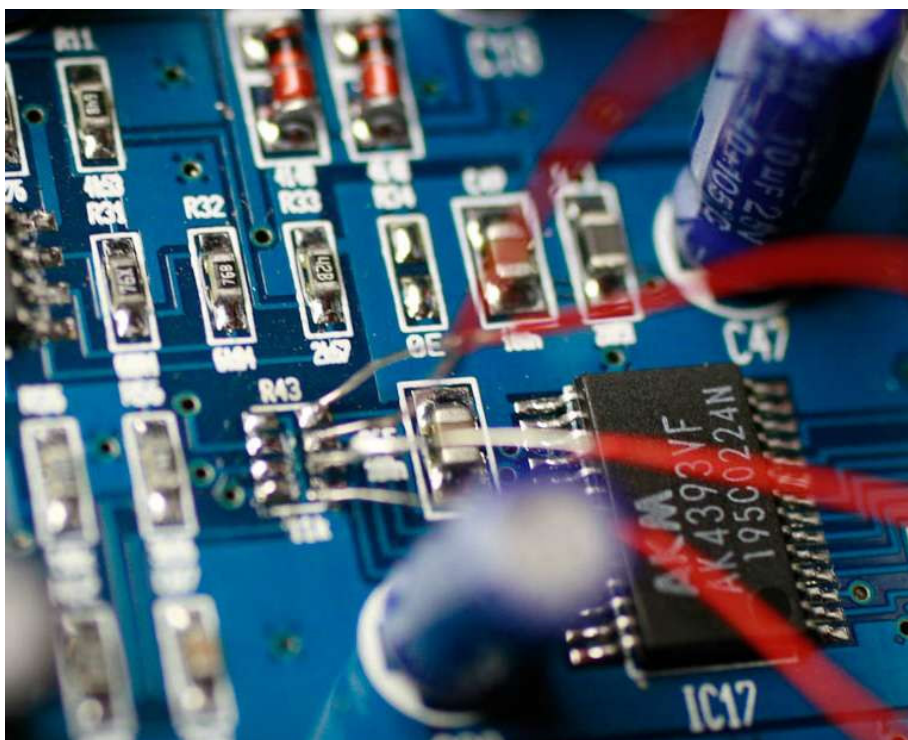

This system does not require any filter in analog domain.

I wire it naked sauté to the tubes.

If you use single ended solution with one phase - use 1st and 3rd point, or - 2nd and 4th.

Better way is to use them BOTH phases and all 4 signals.



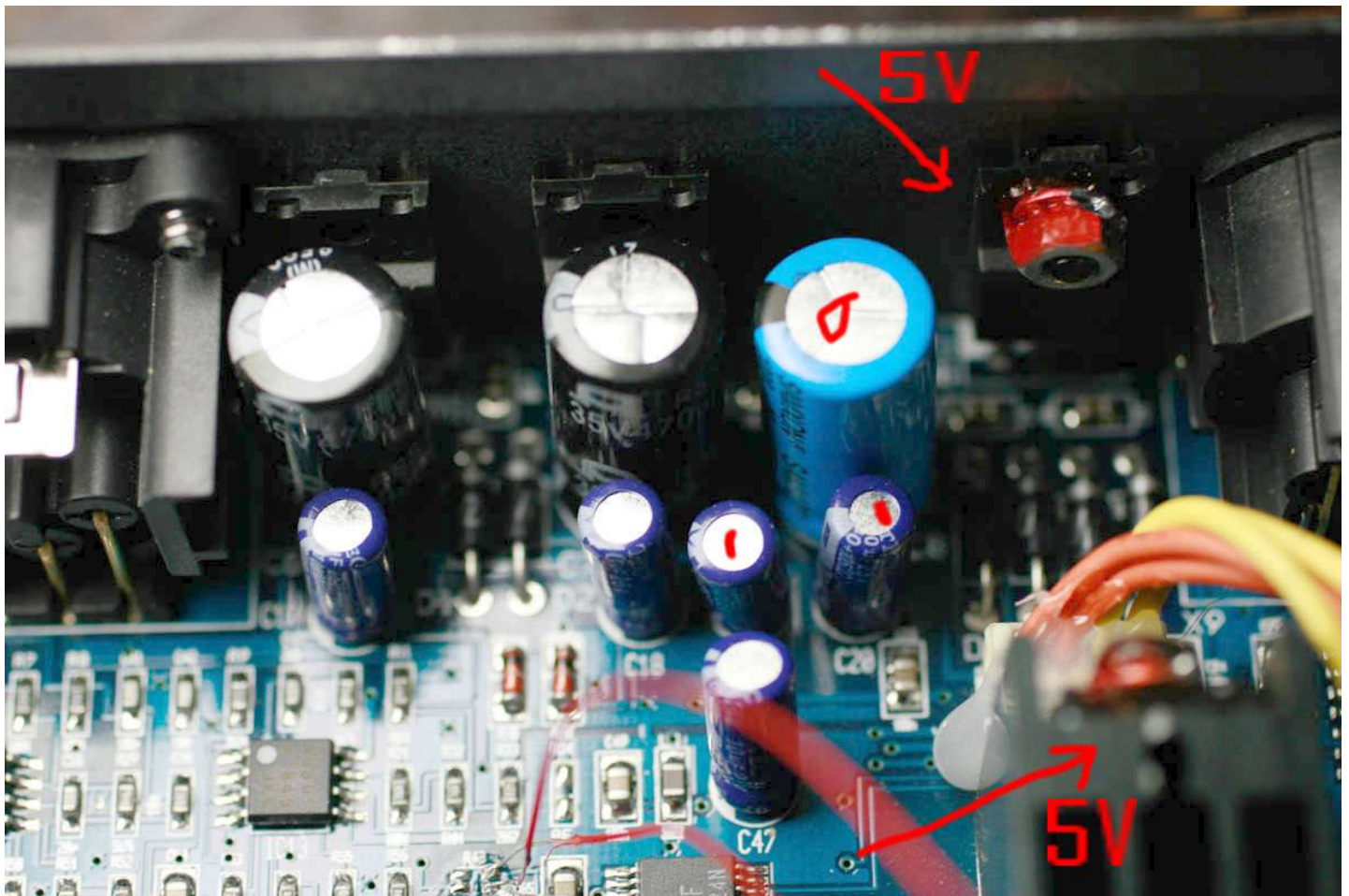

This product has 4 voltage regulators: two for opamps - 15 V and -15V - these regulators are on the back wall, left of the one marked 5V above. Their role is for output opamps and headphones. I did not need that so I have cut off their respective AC power - the yellow pair from transformer.

Other than that - there are two 5V regulators. Main one is on the back wall with big screw. This one supplies the DAC and some other parts. In all, 5 caps buzzed to confirm connection to this regulator's output.

The biggest blue cap above on the photo with red circle mark is BEFORE the 5V regulator - it is the main raw supply. You need a 16 V minimum rating for this cap, and a minimum of 1000 uF. I used 3300 uF Nichicon.

I experimented with the remaining 5 small electrolytes, and the small BG HX HQ 22 uF were best for me. I did not like oscons there - can't say why.

Later I decided, that since I am adding the new transformer anyway - I may replace the stock miniature transformer (the small EI below)

The stock trafo has two secondaries:

10 V for the 5V DC regulators (our good supply) and 18 V for the opamps. Cutting the opamps supply - yellow pair - does not affect the digital functioning of the Behringer but the trafo has easier work when the opamps are killed.

So you can cut the yellow and keep the orange wires.

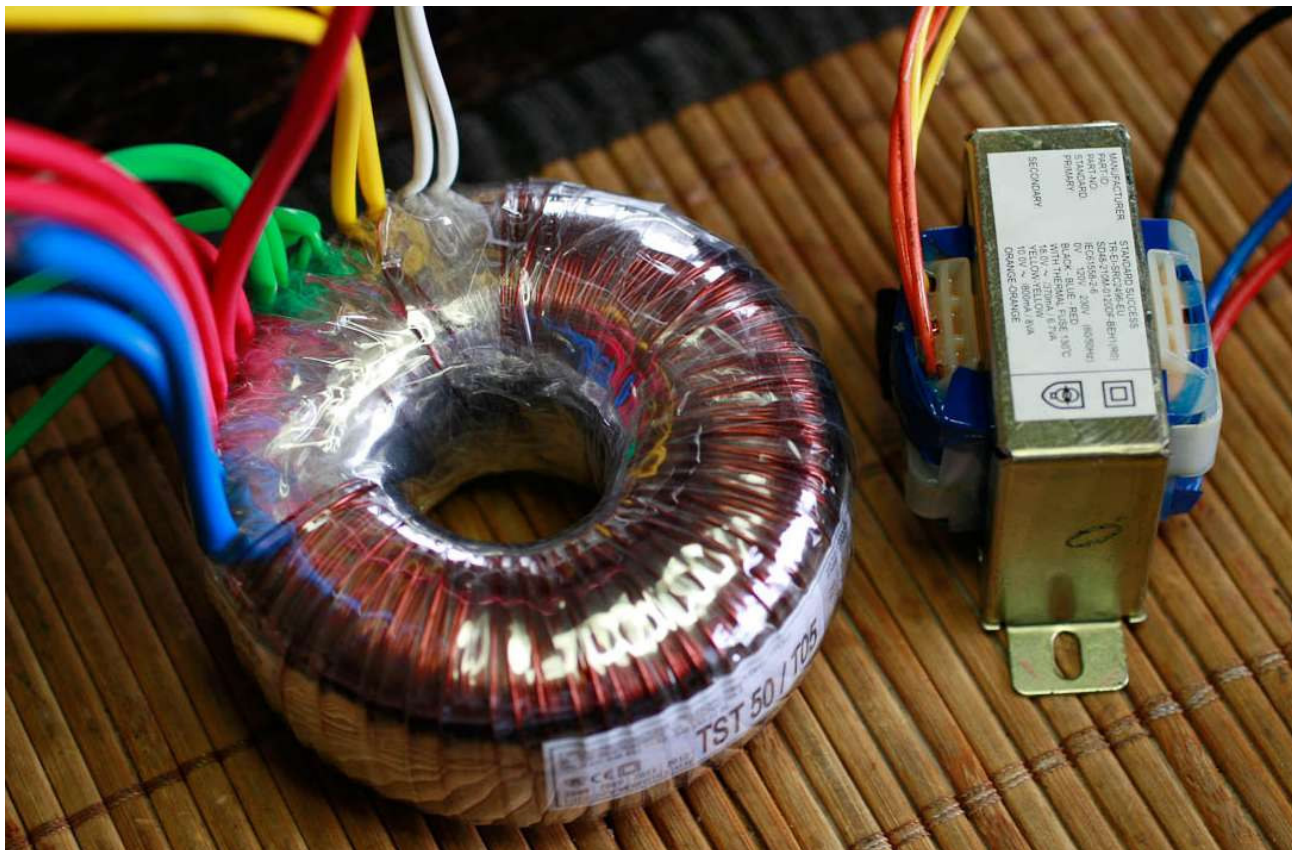

The big trafo is my new Lampizator transformer with 5 V (for rectifier tube heating) 2 x 6,3 V, 2 x 12,6 V and 2 x 230 V ac You can do any tube circuit imaginable with it. I decided to use the 1A secondary 6,3 V AC for the Behringer in place of the stock trafo, and then - build the lampizator. 6,3V rectified gives 9 V DC, ideal for 5V regulators. BUT WRONG WAY !

This did not sound good at all.

Then I used 12 V secondary (18 V rectified) and it sounded much better but the regulators overheat.

So I went back to the stock trafo - the 10 V AC output (15 V rectified) and it is just perfect. Without the opamp load - with yellow wires cut - the stock transformer is really very good.

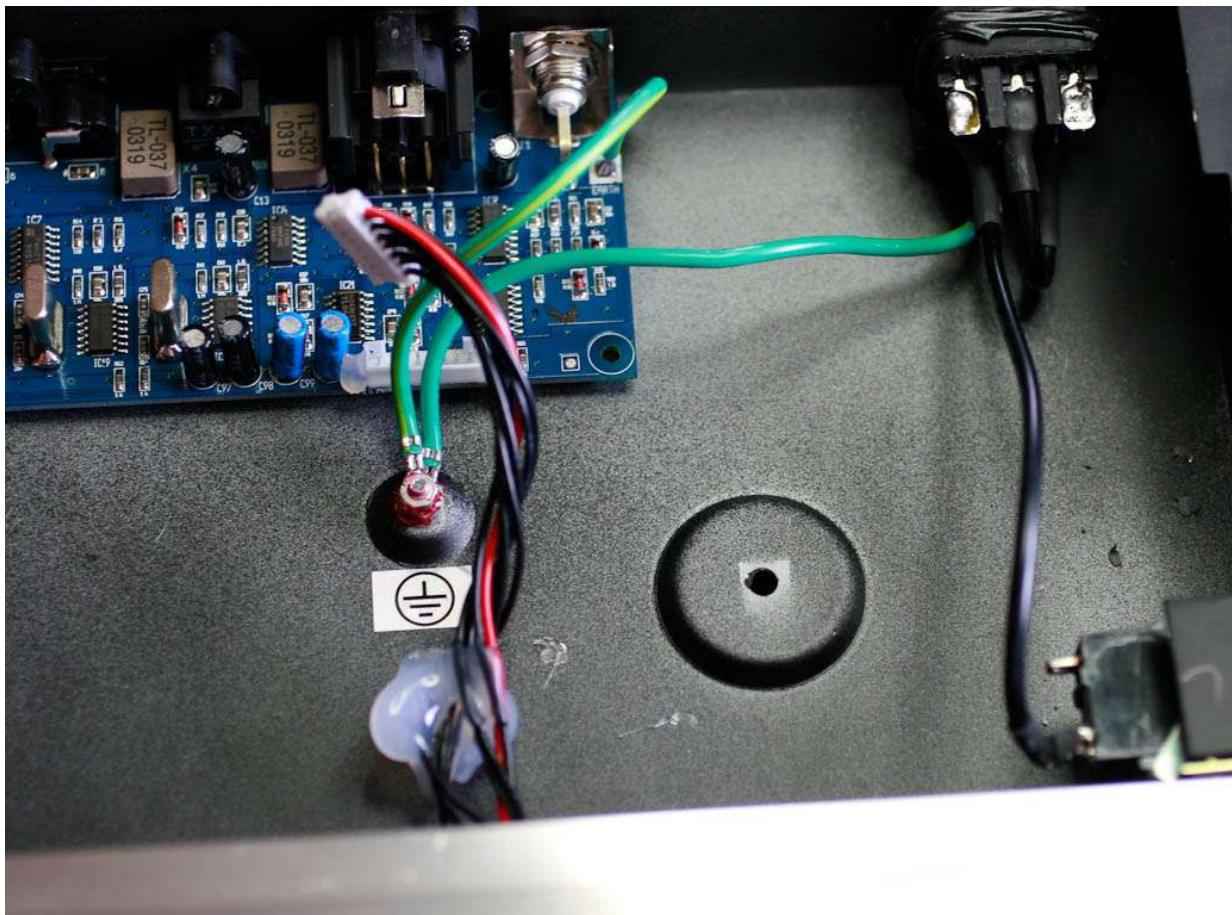

As you see above there is a provision for the star ground point as well as toroid transformer mounting nest. Just perfect.

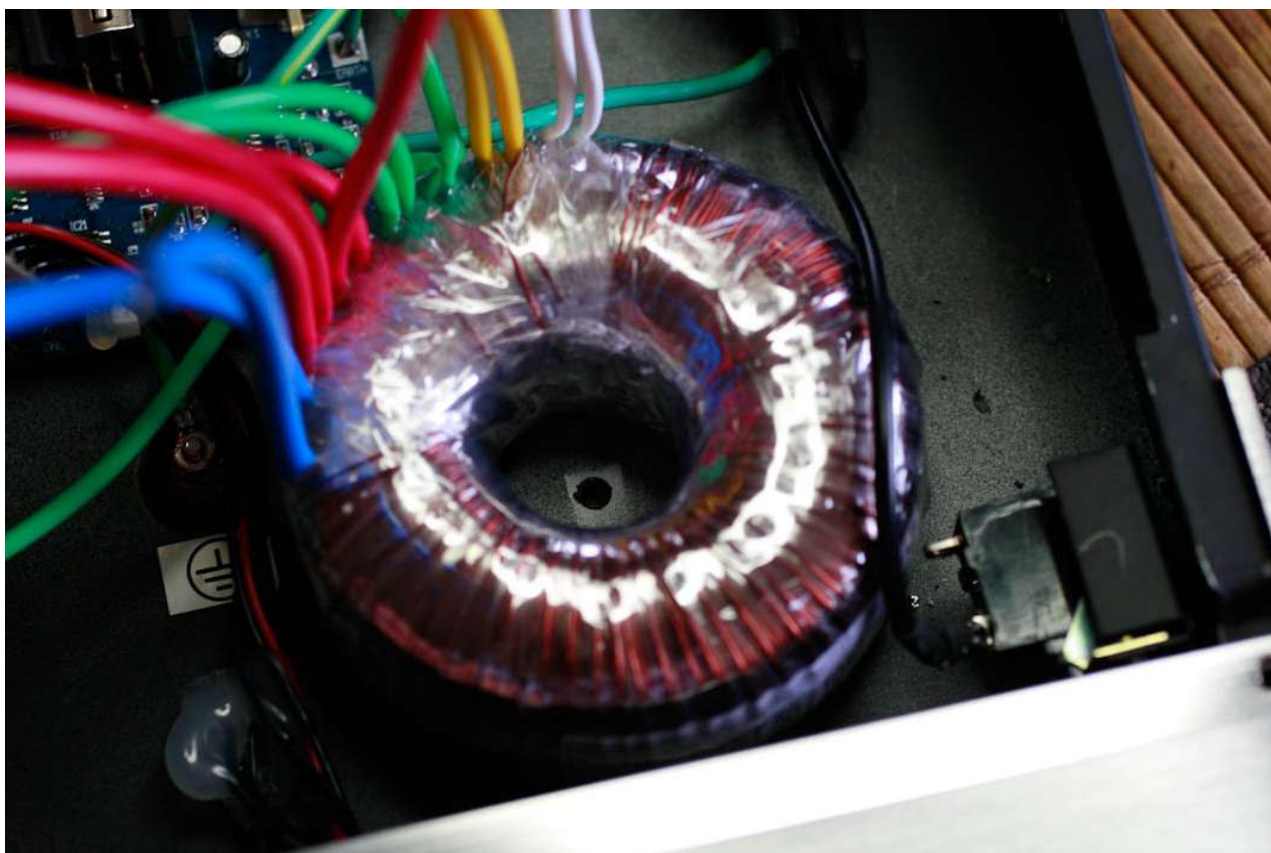

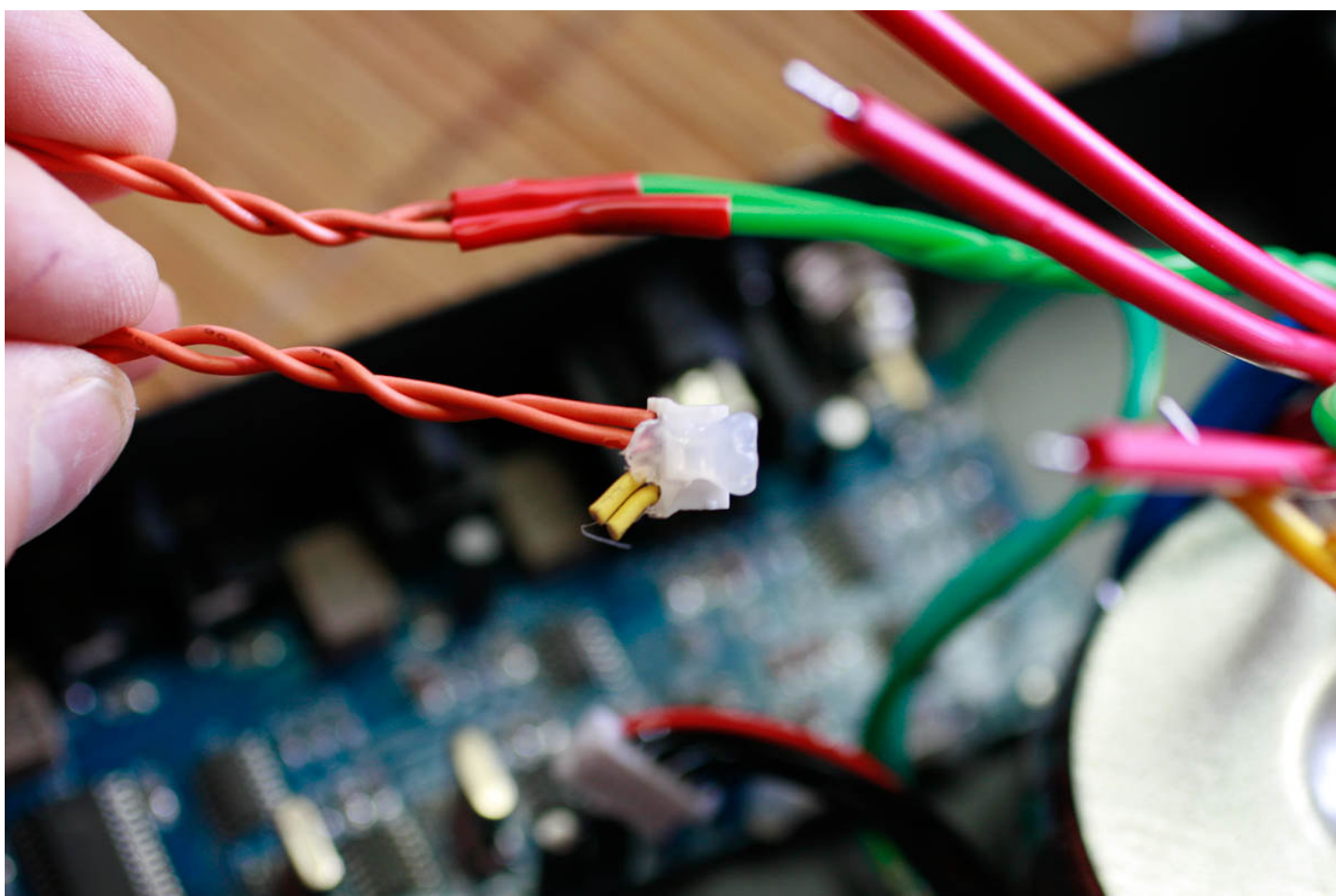

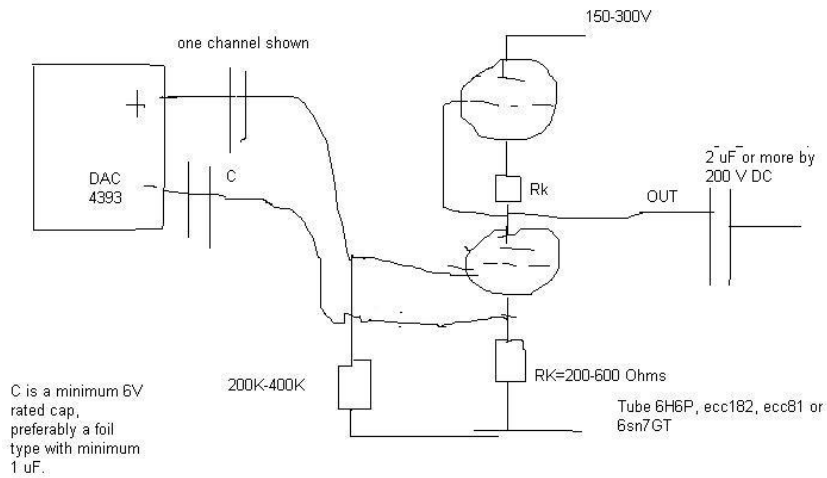

If you are one of those persons who need exact recipe - use 330 Ohm Rk, 200 VDC Ua, 250 K grid resistor, 2,2 uF input caps MKP by 160V or more going to grids, but the other phase of signal must have bigger cap - 10 uF is an absolute minimum. I used 22 uF Tantalums, plus side towards cathodes. . All resistors 1/4 W metalized 1% type. Tubes - any choice from the above list. My best pick is e801cc from Siemens or 6H6P Russian.

Below in the schematics of power supply use 20 or 40 mH choke by 20 mA or more.

Here comes my cave wall painting power supply schematics:

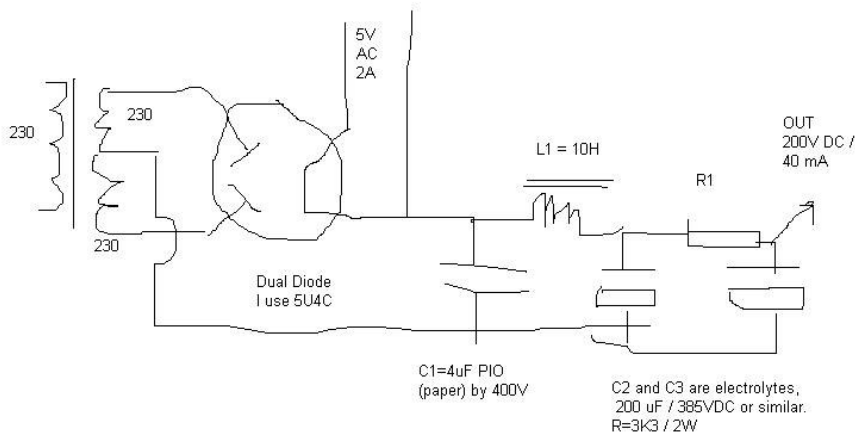

**OK , OK, I AM NOT GOOD AT DRAWING !!!**

[Download schematics of Behringer HERE \(2 MB\)](#)

## BEHRINGER PROPERLY LAMPIZED

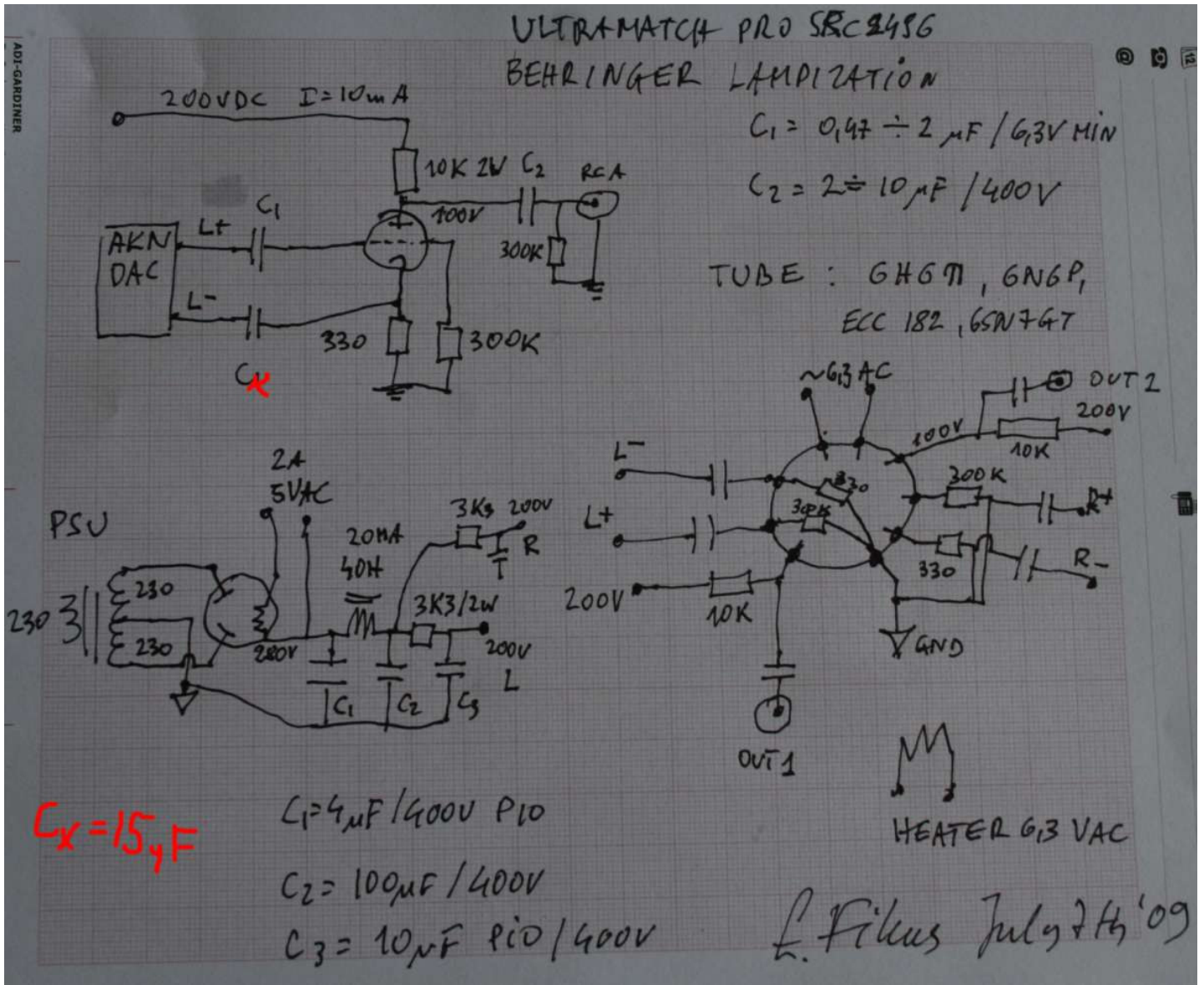

The above is a one tube variation of the previous scheme. This is my actual reference in real life. Very elegant and pure design.



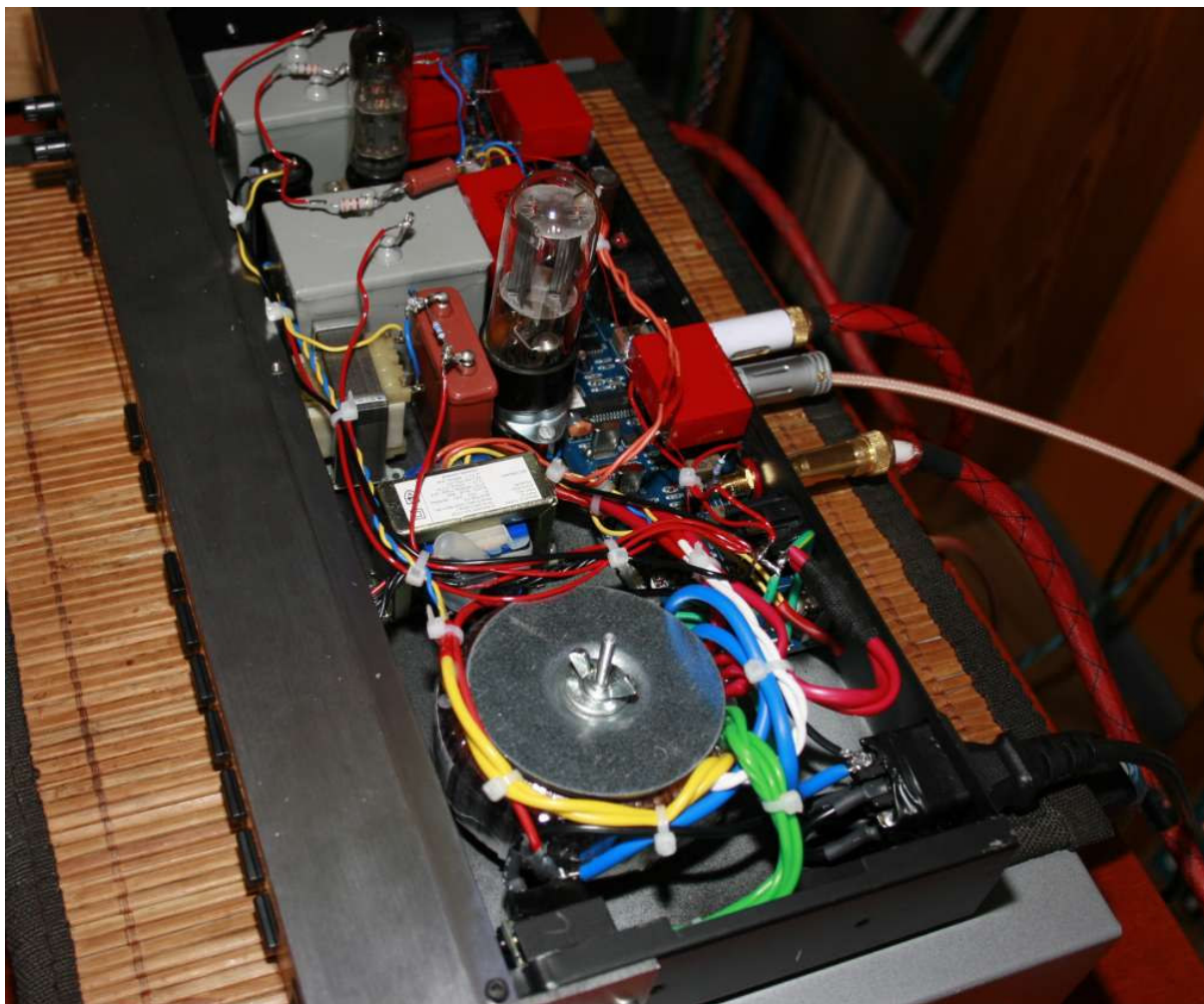



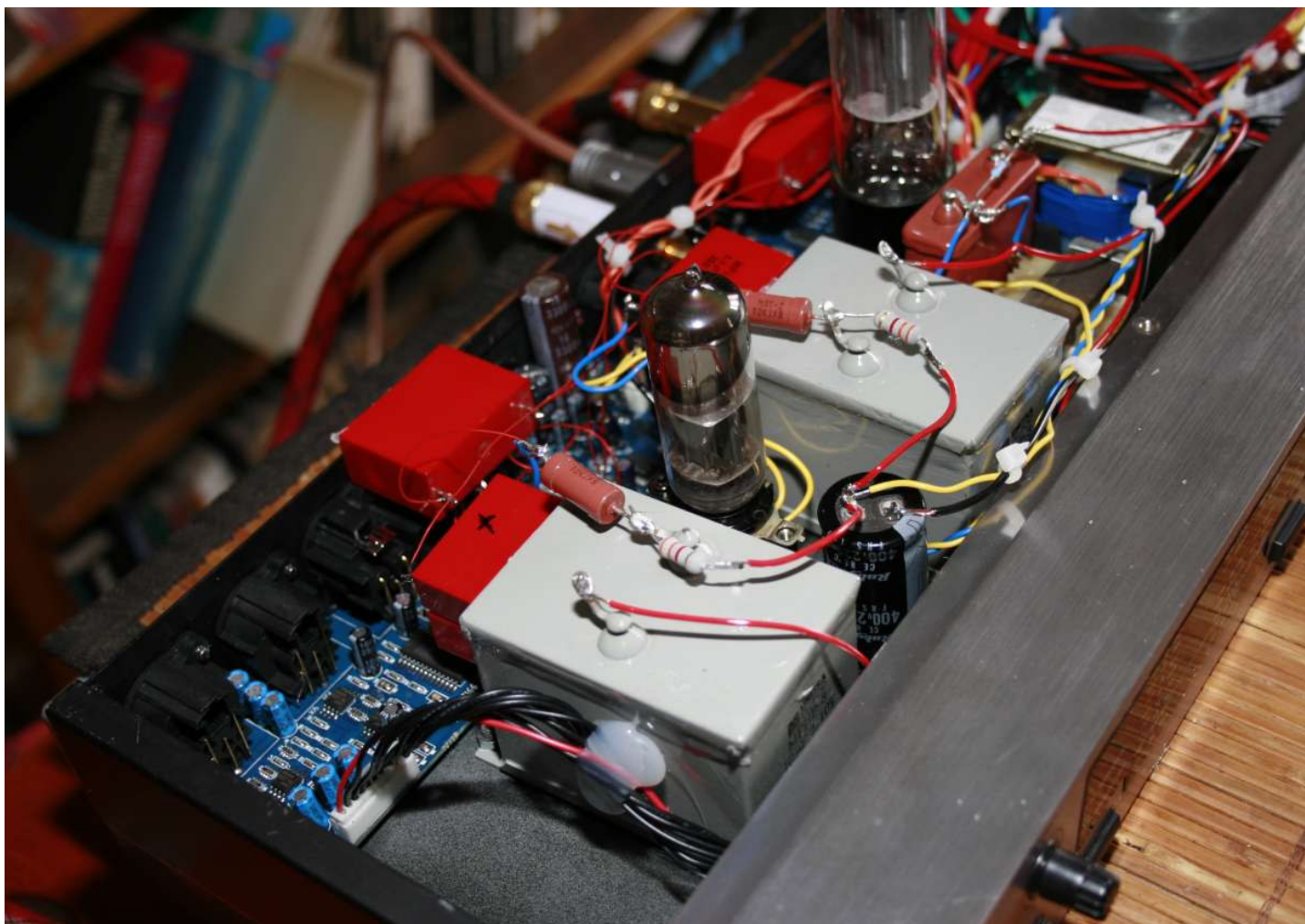

=====  
 July 18 2009

I want to get better results - my analog stage is almost perfect. There is not much more one can do.  
 Of course everybody is more than welcome to try and do better. I am not claiming to know anything about tubes, I just have fun trying various solutions.

To better the above design one can:

1. Make dual mono construction with two power supplies.
2. Use exotic parts. I tried to use **electrolyteless** design with all PIO in power supplies (first - 4 uF as maximum allowed by tube datasheet for the diodes, and then - two caps of 10 uF after the choke. It is very clean design and sound.
3. Make it fully balanced by using one triode per phase per channel. In that case - the minus signal is used the same as plus (to the grid) in separate triode. (second triode of same tube).

Now I am going to upgrade the Behringer PCB again.

I already upgraded the power supply caps to a mix of tantalums and oscons.

The output analog stage can be upgraded (opamp power supply and coupling caps) and it will give very good results. But I opted for lampization instead, because no matter how you tweak the opamps - they will not even come close to tubes. The energy and slam of tubes cant be matched. It is like comparing the traffic light acceleration of a car and sport motorcycle.

Anyway - my next step is the DIGITAL INPUT SECTION

Thanks to my audio buddies relentlessly searching for the Holy Grail, I already got some tips.

1. The digital signal comes in via a digital transformer.

Its role is a mysterious one. It sits there God Knows What For. I know that a telecom cable buried under a desert needs a transformer to avoid the ground potential differences and to protect from damage. (by the way - the modern day S/PDIF receivers are offspring's of the broadly used long distance format called RS422).

But since we are not sending our signal over a distance, under the desert, and by the cable that's one mile long - we don't need the transformer at all.

Our receiver is a simple device - it sits there waiting for the zero to become one or vice versa. A simple gate is triggered by the square wave going up or down. The gate could not CARE LESS whether the signal arrived by the cable of 75 Ohms, by a coax, twisted pair, lamp cord or else. The transformer can not add any value added to the zero becoming a ONE. So in DAC-Transport connections we can completely ignore the whole "75 Ohms" hysteria.

Why inside players the same digital signal can travel over one metre of thin trace without any transformer and any 75 Ohm termination? And in outside cable - all of the sudden - it MUST ???

I know that I am alone here, and every audio guru, specialist, salesman, critic or even engineer will tell you that the S/PDIF transmission MUST be terminated at both ends with 75 Ohms and the plugs must be special and the cable must be of characteristic impedance 75 Ohms. However NOBODY EVER demonstrated that it matters to the sound, or even to the oscilloscope or the "happiness" of the chips involved.

Of course - the ONLY proper way of sending a fast signal far away is to use not coax but twisted pair and balanced signal. THEN WE DO need the transformer at each end to de-symmetrize it. Or in case of receivers - like CS84XX - they have already built in symmetrical inputs.

After removing the transformer, we can connect our good new RCA directly to the output positive leg of that transformer.

This brings audible effect comparable to a MAJOR cable swap or tube upgrade from chinese to NOS.

We can stop there.

For the open minded, Mister Andy - the Shigaraki guru - proposes to go further and remove the first chip on the input - the analog multiplexer. It is needed only for the people working with multiple digital inputs at the same time. THANK YOU ANDY for being so restless.

We small mortals just need the Behringer to play one input - S/PDIF from our transport.  
Actually I may be using the second input for the Squeezebox..

What Andy did is simple: he found the input leg of the upsampler chip CS8420 which has the S/PDIF readily available as input - and he wired that directly via a series 100 nF cap to the RCA input. Bypassing the MUX chip completely. Connect to the POSITIVE input of the chip, and wire the RCA ground to the digital ground point nearest to the Upsampler chip.

[HERE IS THE DATASHEET OF THE MUX CHIP](#)

My advice is verified by first hand experience. It is excellent upgrade !!!

Just look:

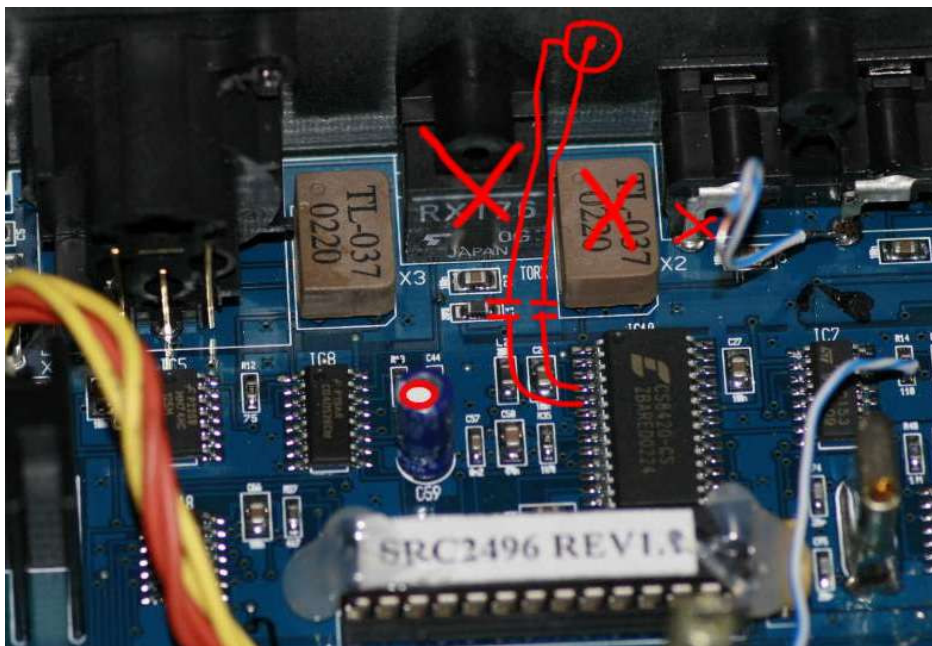

With a magnifying glass or just very young eyes you can solder a thin thin wire to legs 4 and 5 of the receiver - upsampler DAC.

Leg 4 gets plus of S/PDIF and leg 5 the insulated minus (not touching chassis).

The minus of RCA should be grounded.

The RCA can have 75 Ohms across or not

The caps from RCA to Receiver are in my case 100 nF MKP, but any value between 10 nF to 1 uF will do. Ceramic 10 n is a good choice, like styroflex, mica, etc. Just no PIO.

While we are at it we can remove also the toslink receiver. It wont be needed anymore.

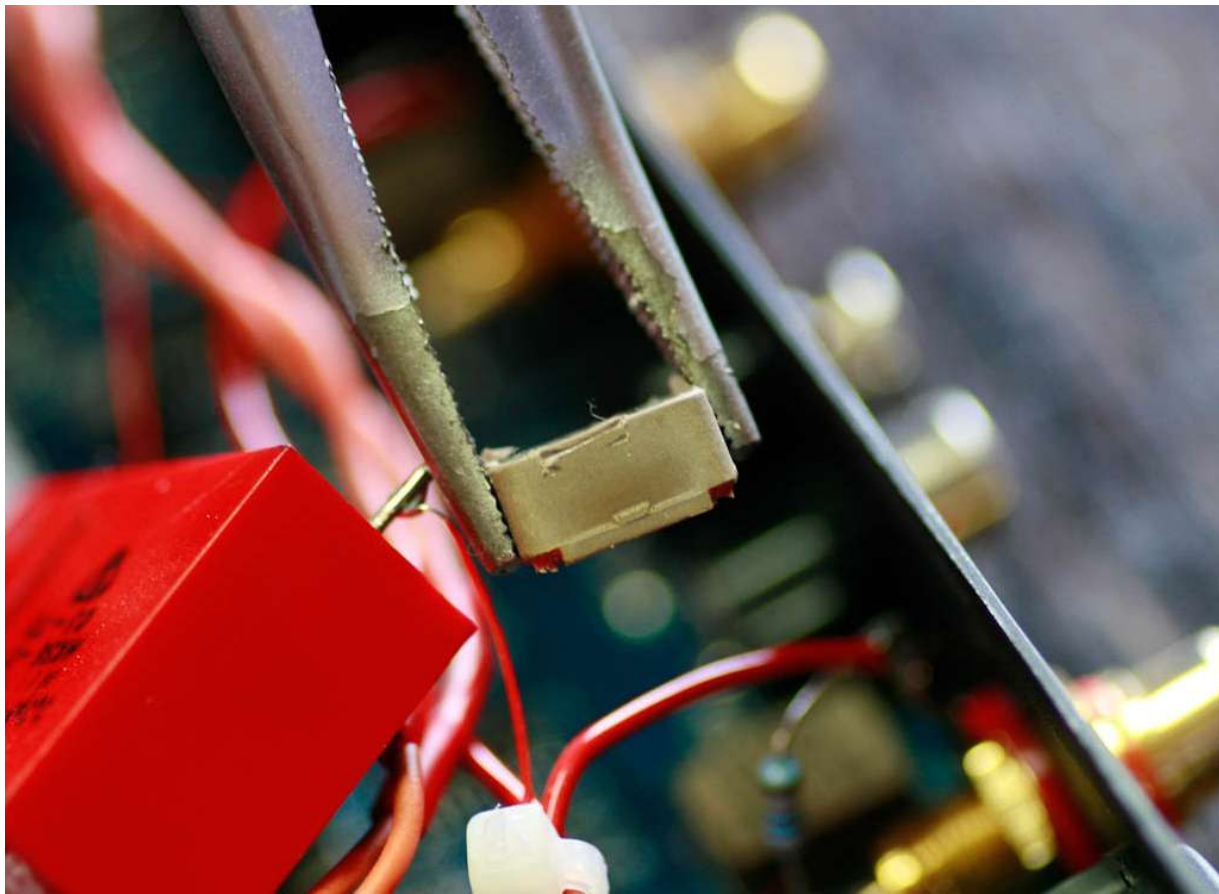
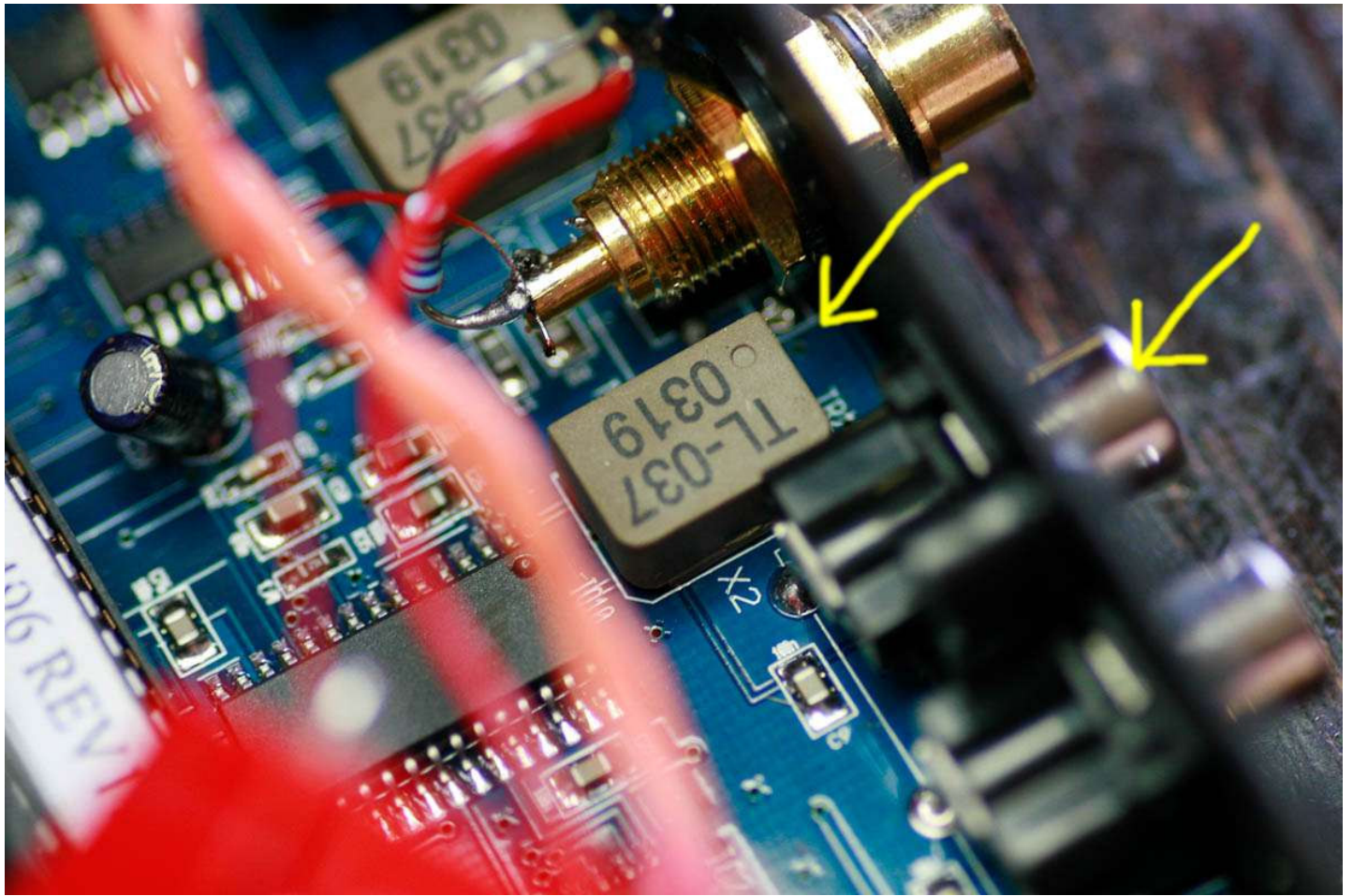

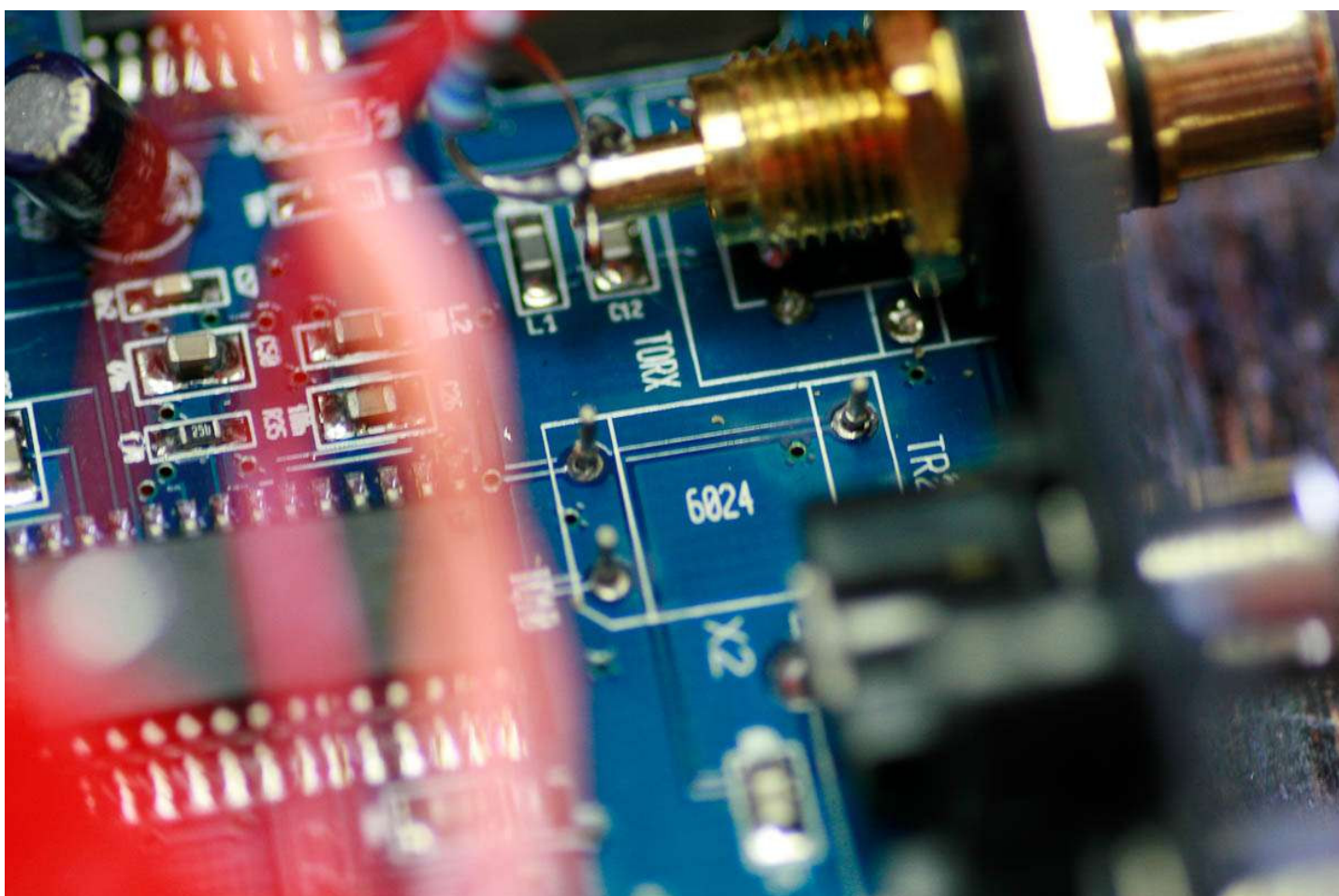

=====

We have no more low hanging fruits here. Going further is advanced tweaking and in fact - not so important anymore.

We could:

1. Upgrade the upsampler chip to the newer, better model from CS
2. Change the AKM dac for the latest and best AK4396
3. Add two regulators for 5V to supply the upsampler chip CS8420 - one for digital - pin 23, one for analog - pin 6 . To do this we need AC of 6-9V, rectify it to circa 8-10 V DC by diode bridge, then go to a cap, like 3300 uF by 16 V DC. After the cap - put two regulators 7805 with left legs to the capacitor plus, middle legs to ground (cap minus) and both right legs separated are outputs. At the outputs we put a tantalum cap - like 20 or more uF by 6,3 V or more. We can of course use any cap there - low esr, oscon or blackgate. Or simply a 4uF MKP or something.

We will get two separate regulated supplies of 5VDC of high quality which we can then feed to the chip inputs of power (after floating them).  
The two regulators do not need heat sinks.

[FIND THE CS8420 DATASHEET HERE](#) .

SOooooo dear folks - we can take pliers and remove that bloody brown transformer like a rotten tooth. Just make sure - you pull the correct one.

=====

2 weeks later

The modded behringer was put to test with the Audionote champs: DAC4 ad DAC2. Both have huge investments in blackgates inside, better tubes, PIO caps etc.  
DAC2 has the good old BB PCM63 and DAC4 has AD1865.

Behringer was for the first time an equal fighter. Even with the 17 000 Euro for DAC4 (plus 1000 Eu for blackgates and upgrades of the A-Note) the Behringer sound was in my opinion more interesting, with wealth of details presented in a very natural fashion. Behringer was drawing me into the music. Audionote DAC4 had to fight very hard to match that.

After 2 hours - the scale started tipping on the Audio-Note side because of long warm-up of Blackgates. But the fact that such battle was almost equal - is phenomenal success. Behringer is a real mature champion. In my case - the cost did not exceed 200 Euro. Even without my cheap buying price and with somewhat more realistic lampization price - the total cost should not exceed 800 Eu. Wow !

Concerning AN DAC2 SE - the battle (in completely different system) was also interesting. In that system I preferred AN DAC2 because of its super natural "jazzy atmosphere" but on detail, space and rhythm - AN had no chance. So it was down to a personal taste thing.

My friend ANDY has made two more discoveries:

1. You can remove the entire front panel and use the PCB alone. The last settings by buttons are memorized in non volatile memory - the settings remain even after power is down for the night. So we can put the pre-set PCB in a new beautiful box.

Andy went even further - he cut the pcb on the line just left of the DAC (analog stage, Analog output, input, ADC) and the DAC still works. Don't forget - we already removed the yellow wire power, the input transformer, the input multiplexer chip and many more.

JUST LOOK:

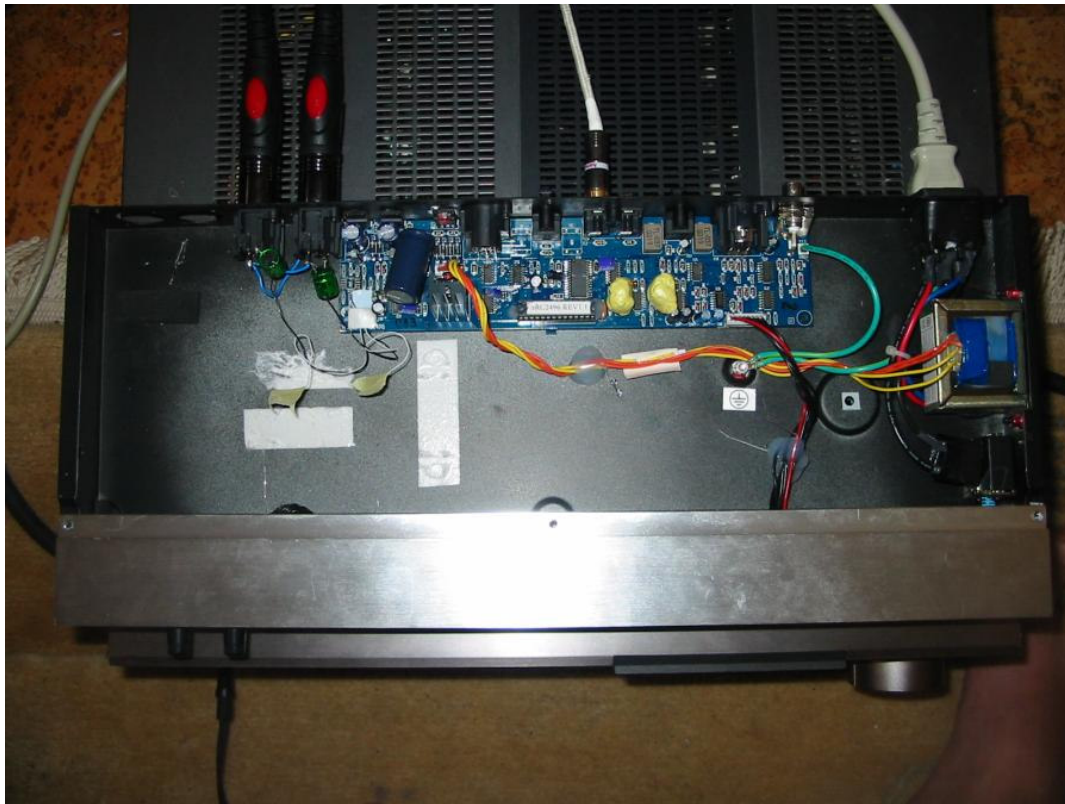

Here is also another product from Behringer worth mentioning - [Lampizator version of Ultracurve](#)

## ONE YEAR LATER

I have an audiophile friend who borrowed my Behringer and he was blown away and he said it is the best CD sound he ever heard and he heard a lot.

So that's how an idea of a commercial production at Service was born.

I designed the new Behringer machine and Waldemar built his first DAC from scratch (what a rhyme !)

My design was to make use of the Ultramatch with the best of everything we can come up with.

Tadadada drums rolling - here comes the world first Lampized Boxed Ultramatch on Steroids. A monster of DACS.

Without a need to skip to the verdict here it is: the sound of this monster is the best I ever heard from CD period. It beats the Audionote 4 and the Buffalo and the Wolfsons and the Satch - it beats them all. Such ENORMOUS power, slamm, resolution, not even the electron microscope but a whole goddamn HUBBLE telescope into the musical event. This experiment almost redefines my whole thinking about what's possible with digital.

I drove it by my squeezebox (untouched virgin one) and the result floored me.

Enough bullshit - here is what I did (by the good hands of Waldemar)

I used a large box because there is NEVER enough space.

I cut away the empty parts of the Behringer's front panel (I mean the alu profile) so the shorter "version" fits inside

I upgraded all 5V carrying caps on the main PCB with Oscons (mandatory).

I bypassed all circuitry of the digital input, transformer and selector MUX and I wired digital in - straight to the chip input leg via just one series cap 10 nF - as described above.

I connected the AK4393 chip outputs to the tube grids via small 10 uF/ 6V oscons in series.

Opposite phase of DAC output is left unused.

I designed a VERY oversized and overspecified power supply for the anodes: with 50 VA core, CLCLC filter, two 40H chokes, one (first) pio cap 1 uF / 600 V followed by a 470 uF rubycon and then the GIGANTIC vintage siemens 1500 uF / 385 V.

The tubes are e88cc philips goldpin SQ series in SRPP config and 300 Ohm cathodes.

The lower cathode resistor is bypassed with an oscon 470 / 16.

$U_a = 220 \text{ V}$

The rectification is provided by a symmetrically driven dual diode tube 5u4C

The total stored energy is BIGGER than in most amplifiers.

The heaters are DC and regulated. We overheat the tubes by just 1 % where they sound more open. We used a 4004 diode from center leg of a 12 VDC regulator to the ground, making it a 12,7 VDC regulator - just for the tubes in series heater arrangement)

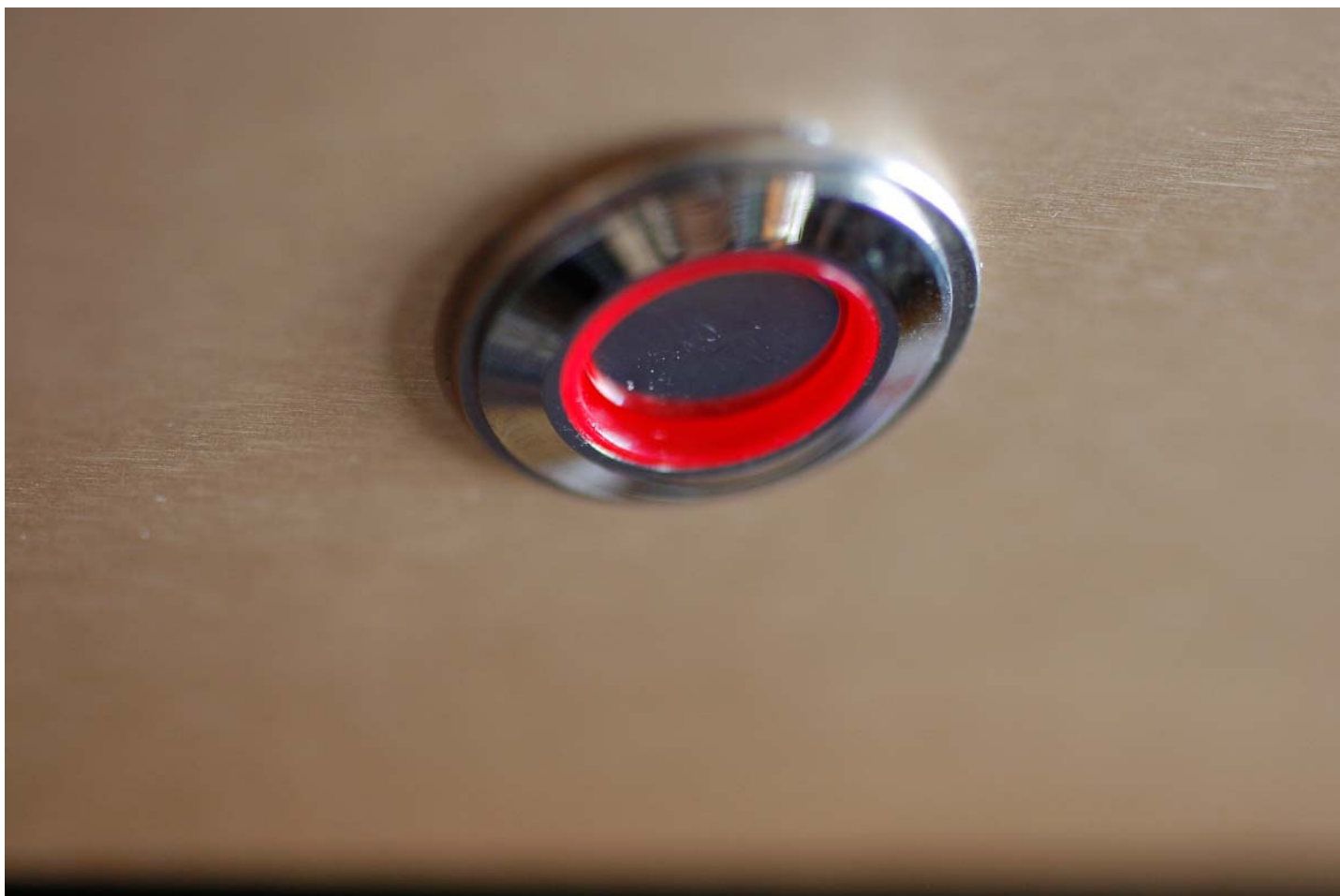

My new naval power switch with a ring led glow.



Detailing of the metalwork

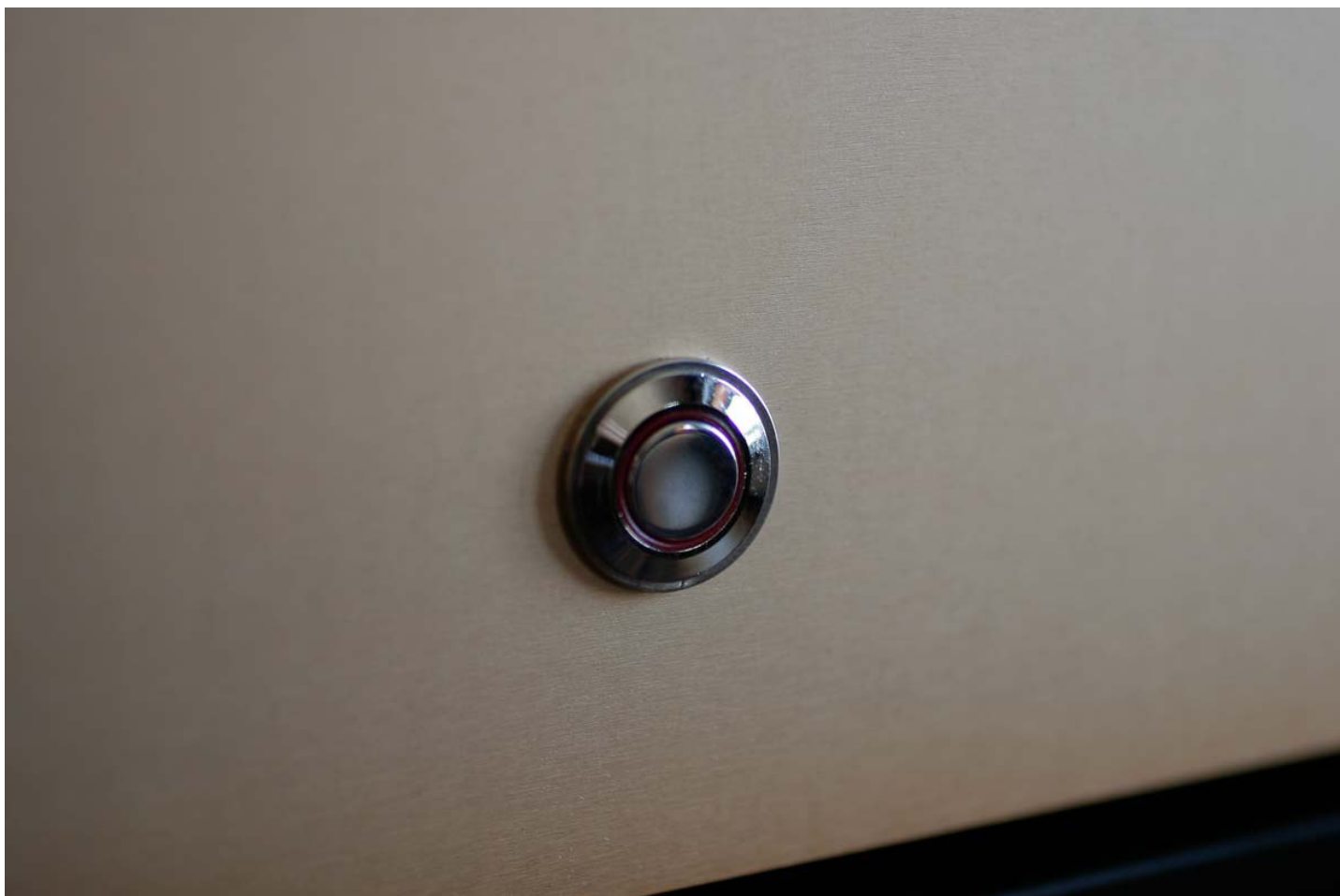

Th switch again





The whole huge box - I mean it is really BIG.



on the back side I designed two digital inputs and two parallel outputs. There is also a fuse and AC inlet with a RFI filter.

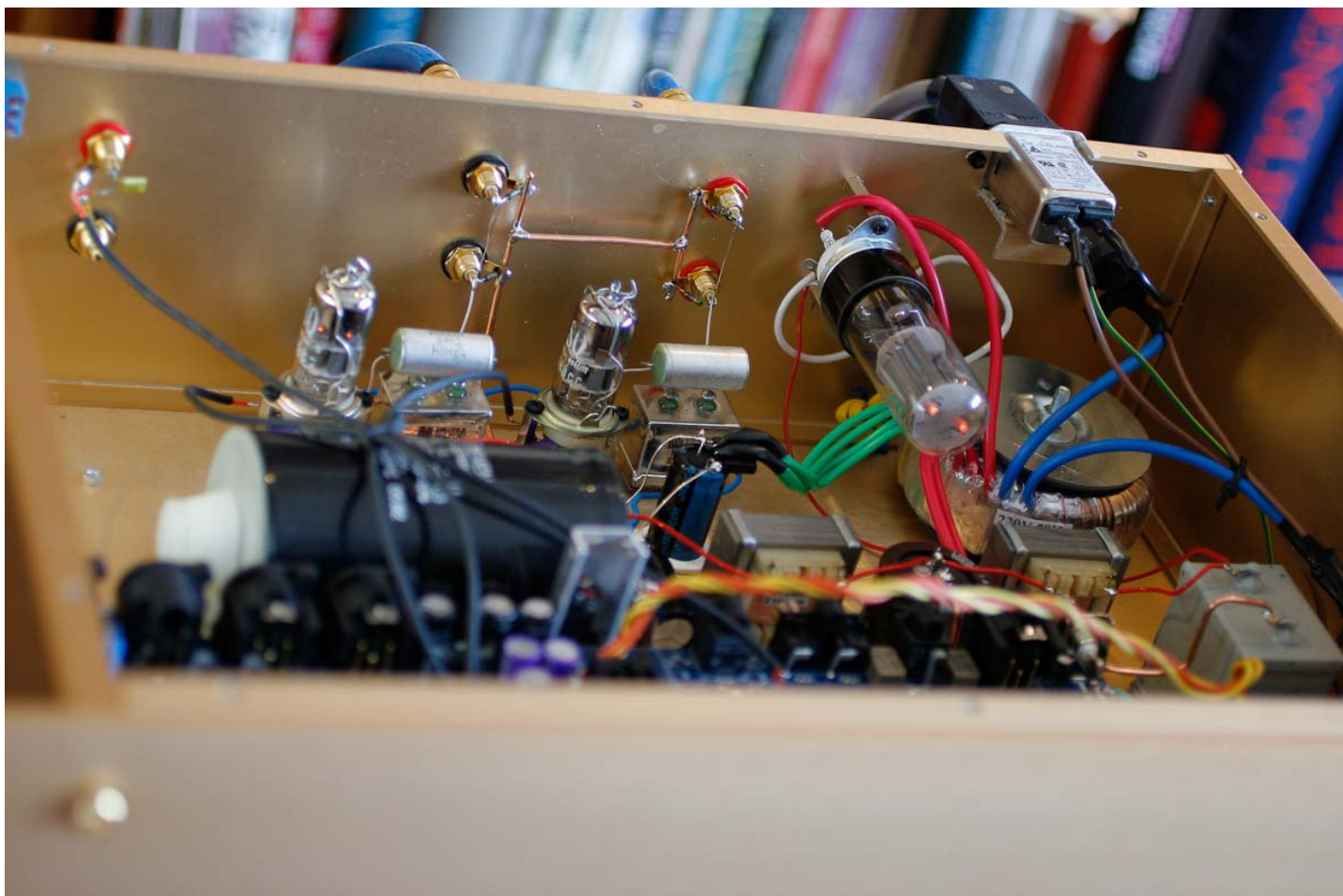

Analog section general view.  
The horizontal tube on the right is the rectification diode (octal type)

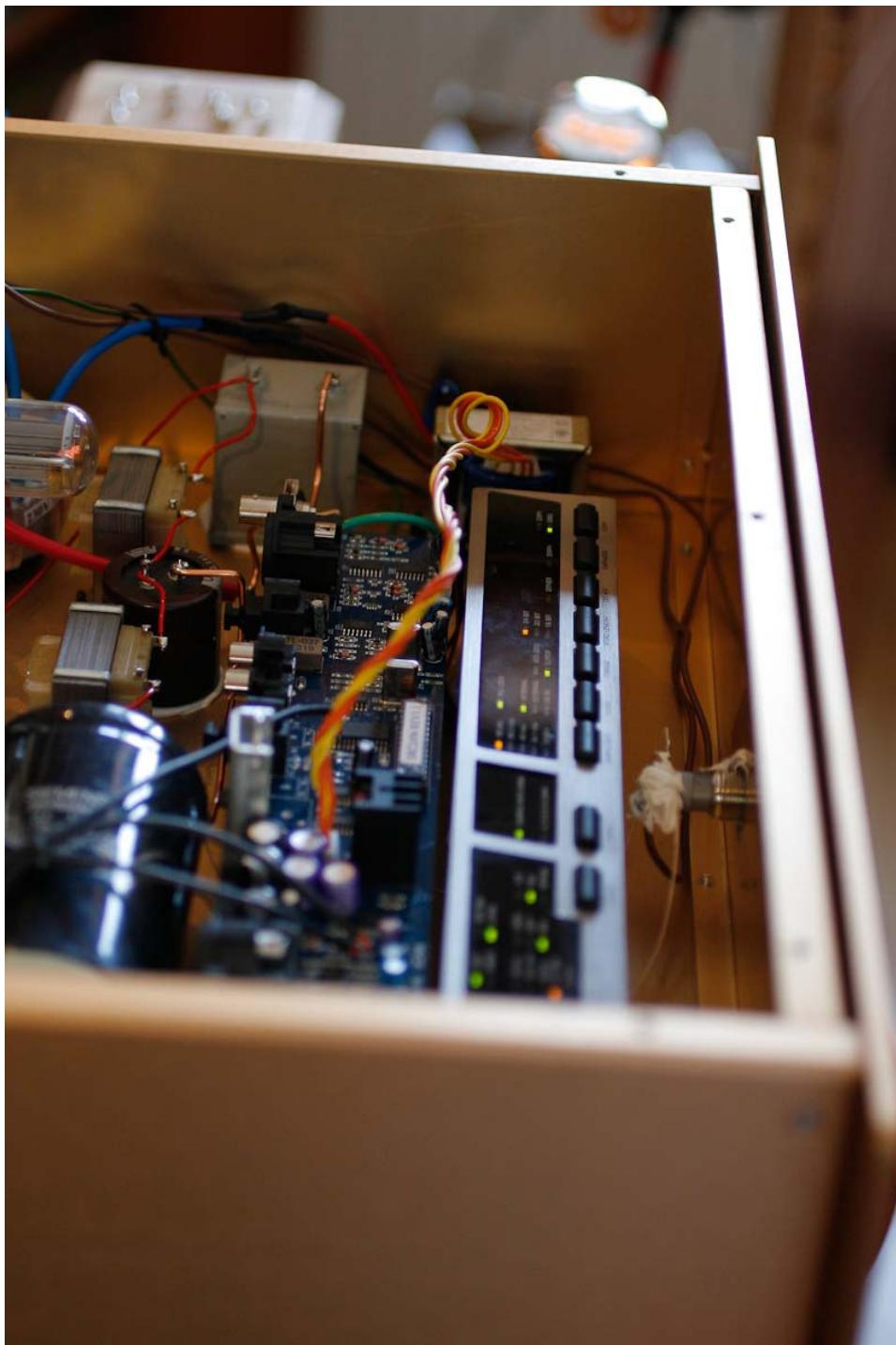

Above the detail of a hidden Behringer front panel.

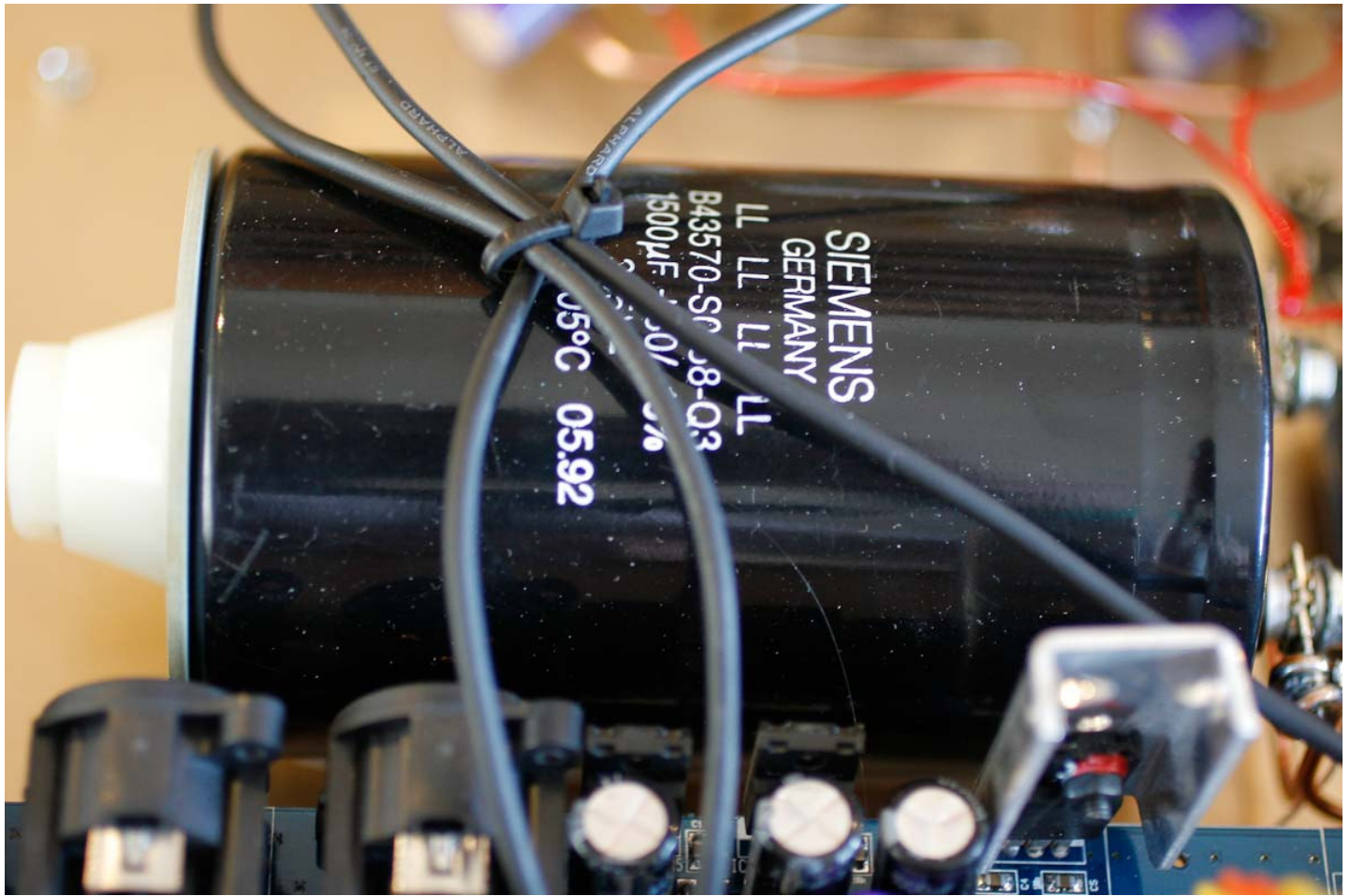

This capacitor is so big - the internal volume is HALF LITER. I used a same cap for Loredana's DAC with the Sabre chip.

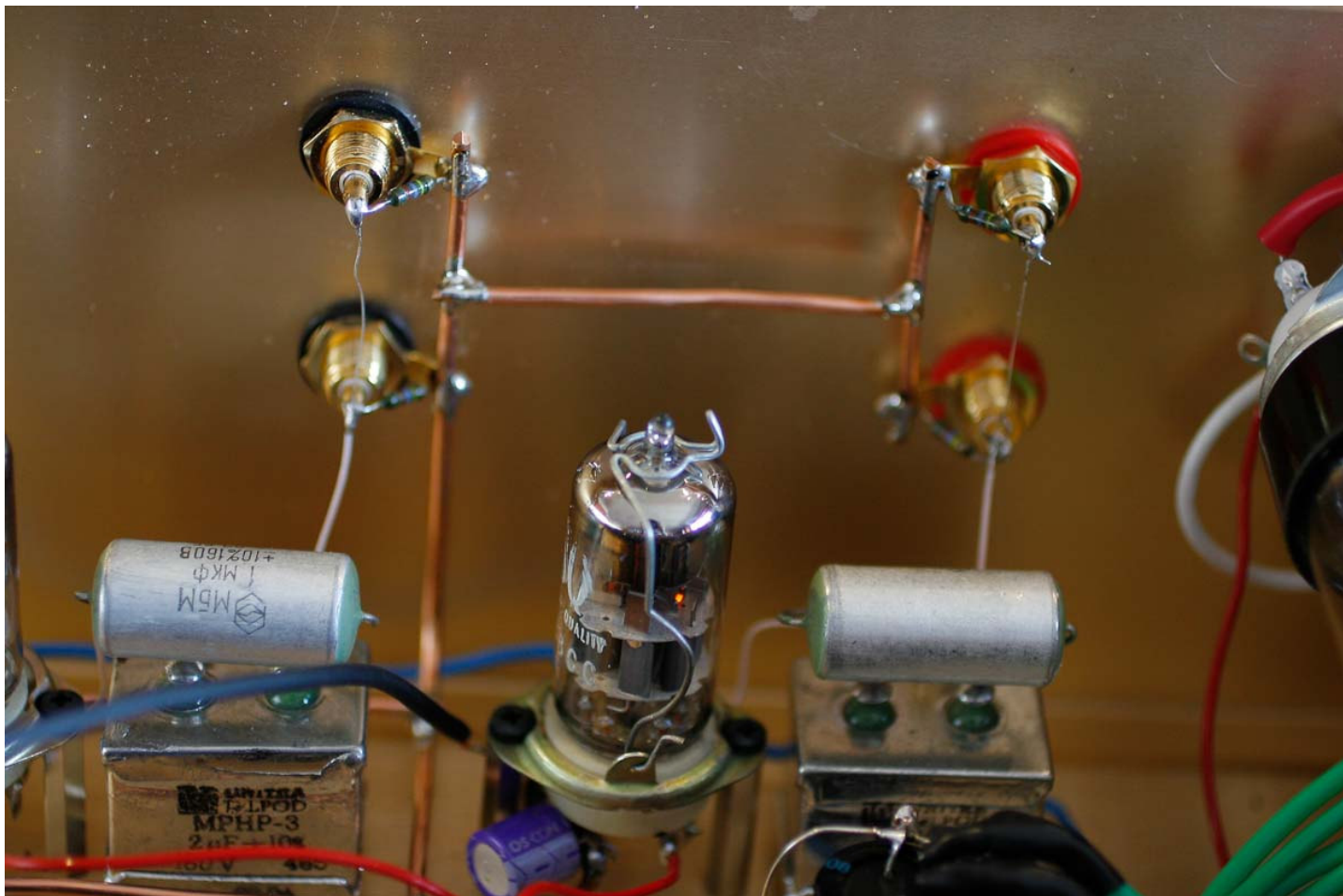

To avoid any hum we used a thick 1,3 mm copper wire for the GND.



These Philips tubes are drop dead gorgeous (soundwise I mean, I am not THAT crazy about tubes to call them gorgeous looking. Not that crazy), beaten only by the siemens.

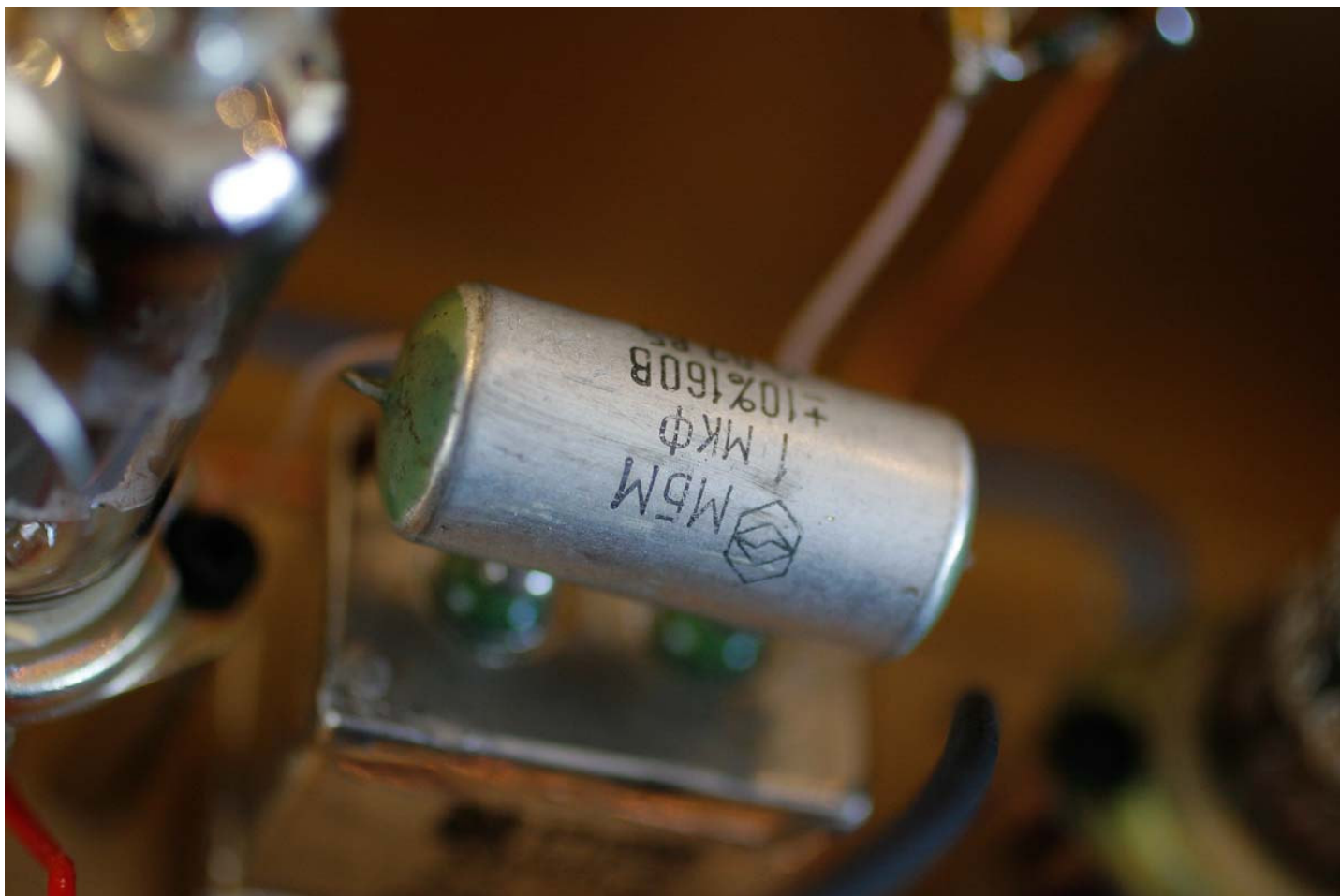

The famous soviet paper in oil - the MB means maslienko- bumaznyj. They are 95 as good as PIO jensens.



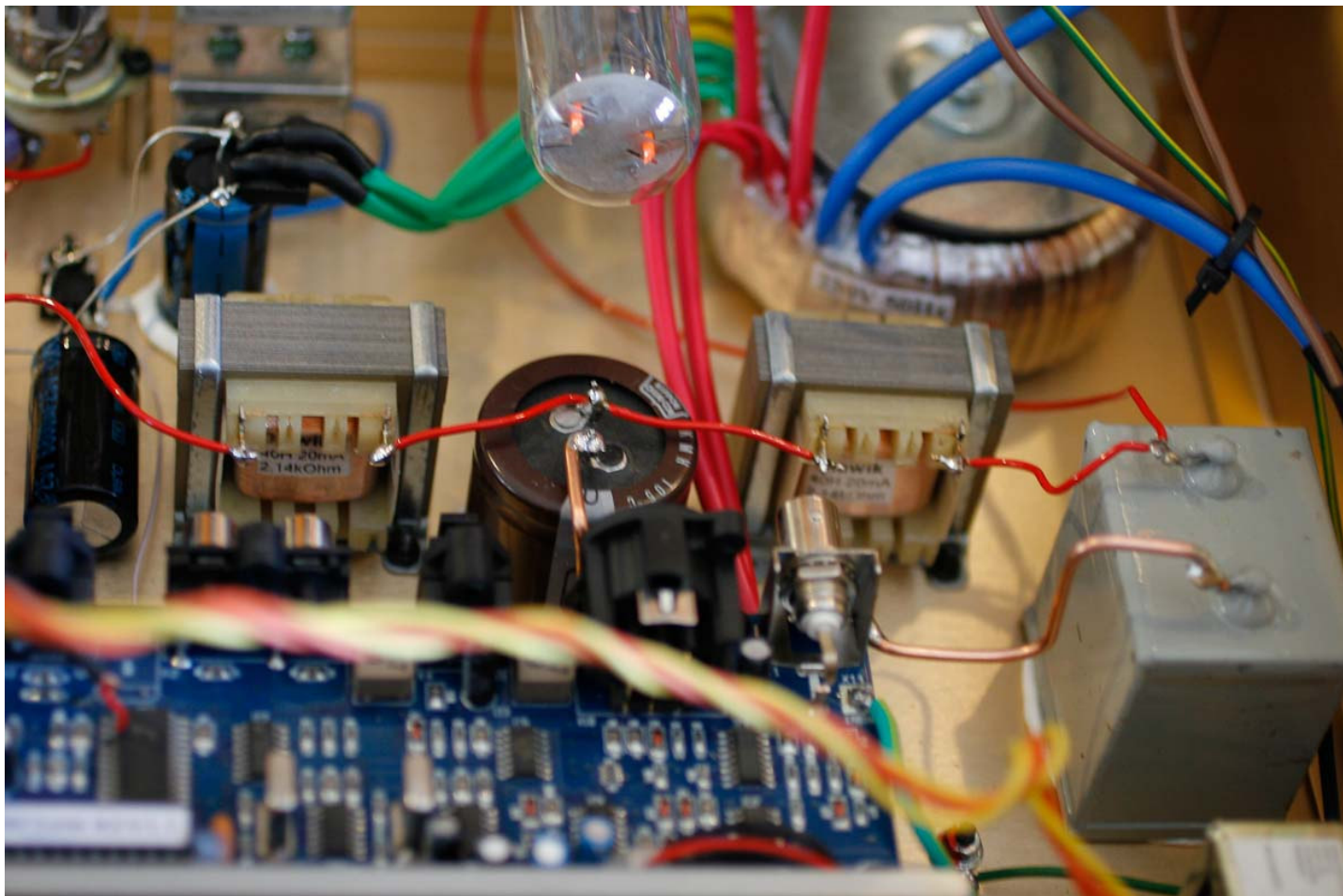

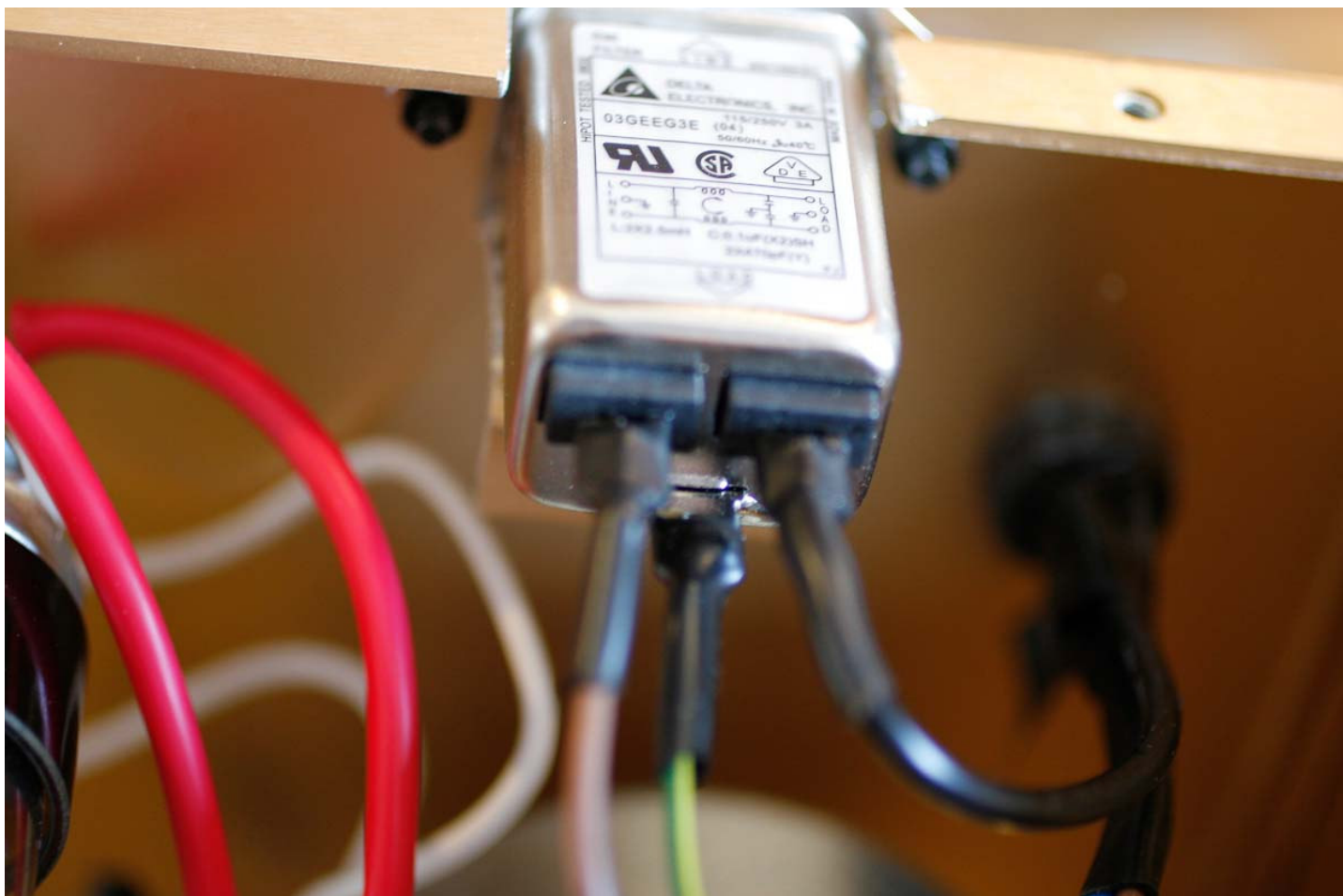



Nice glow of the dual diode

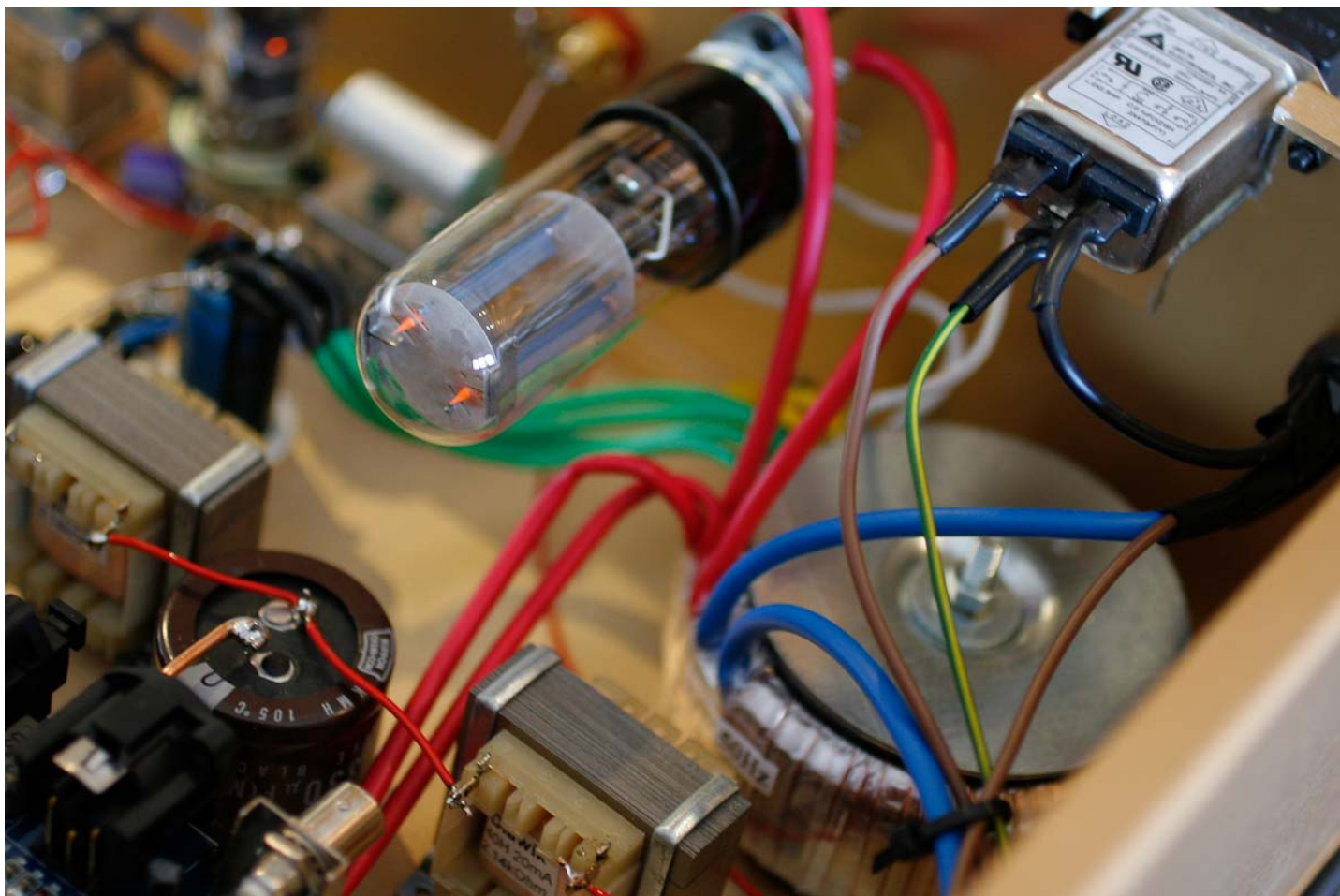

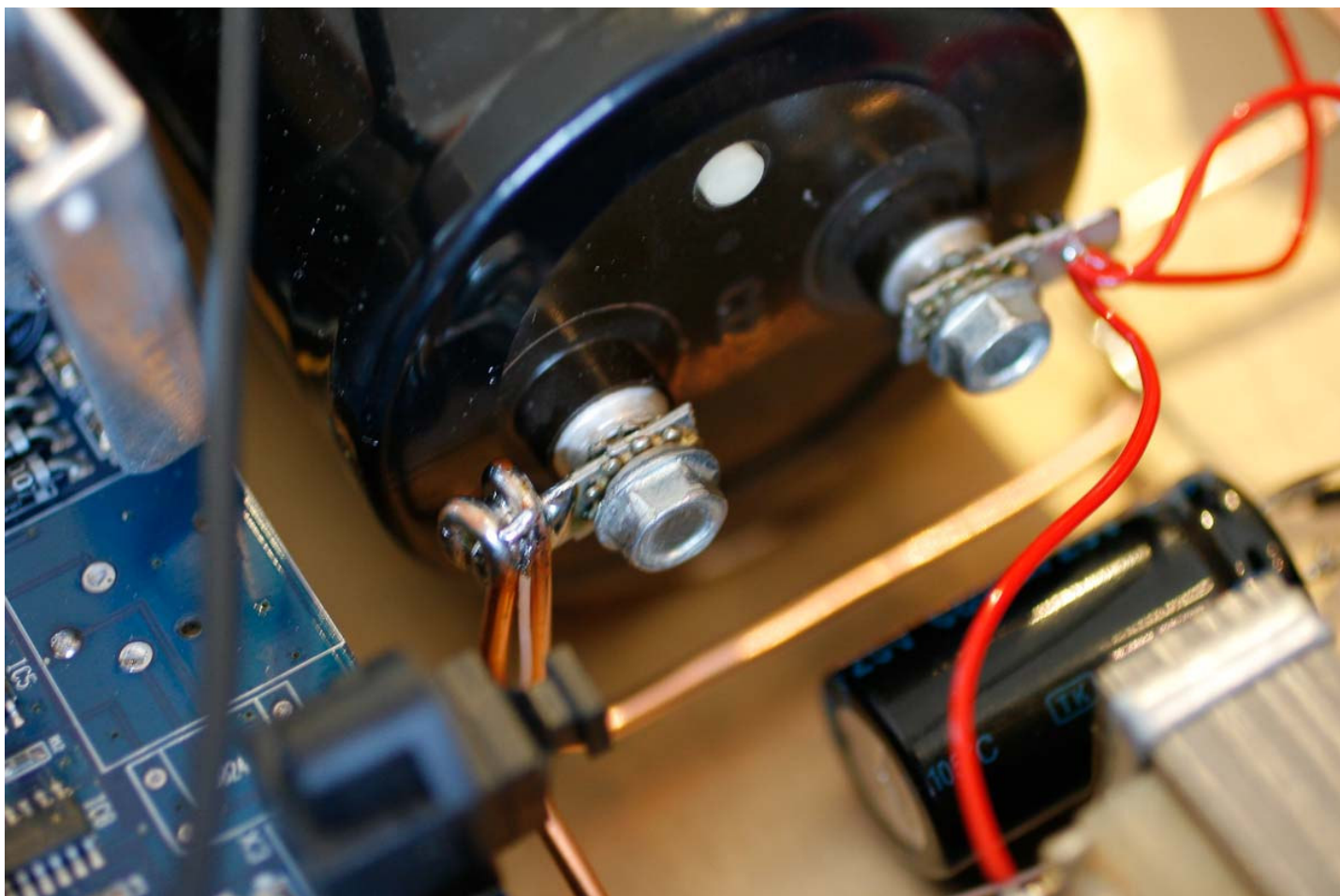

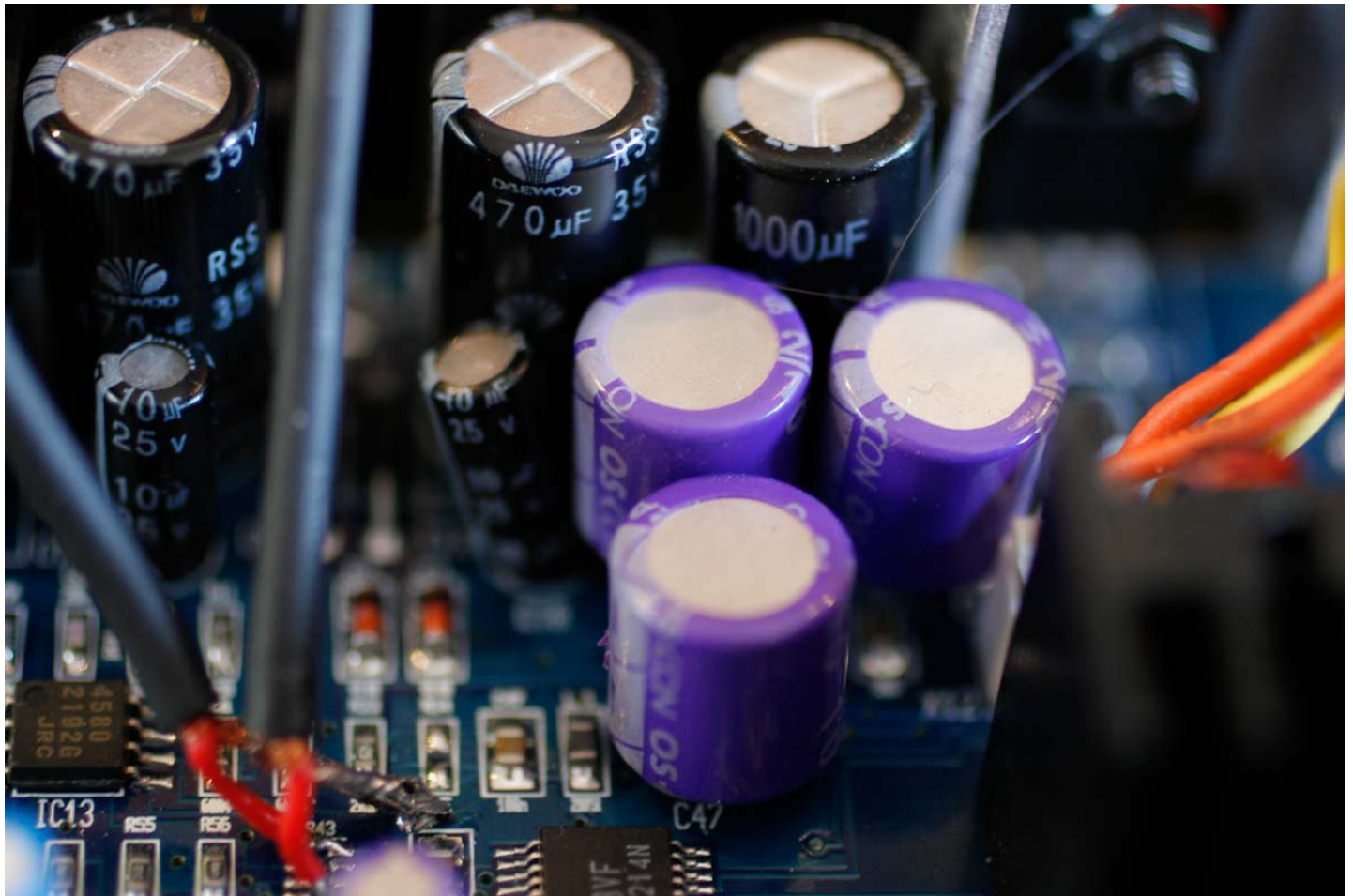

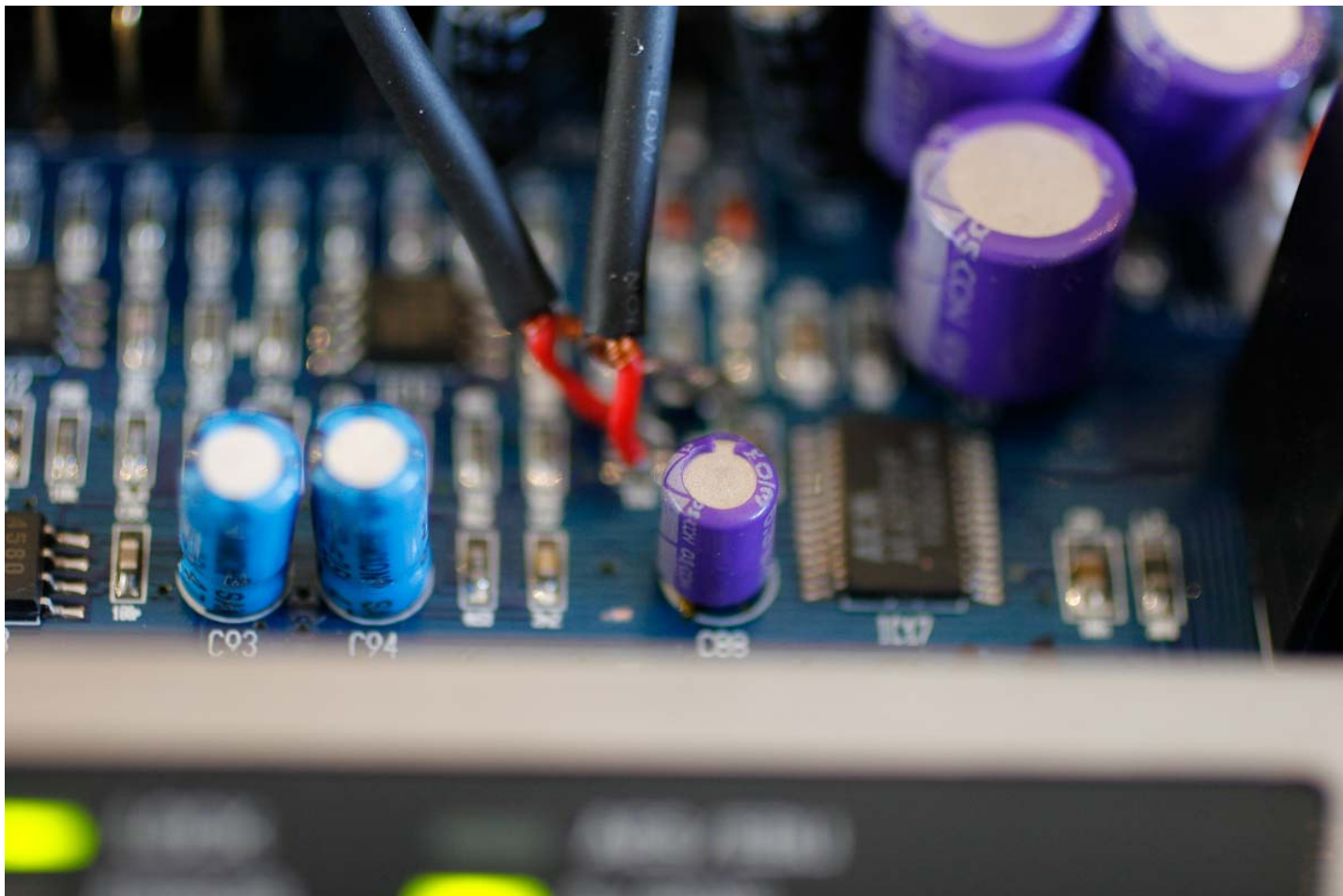

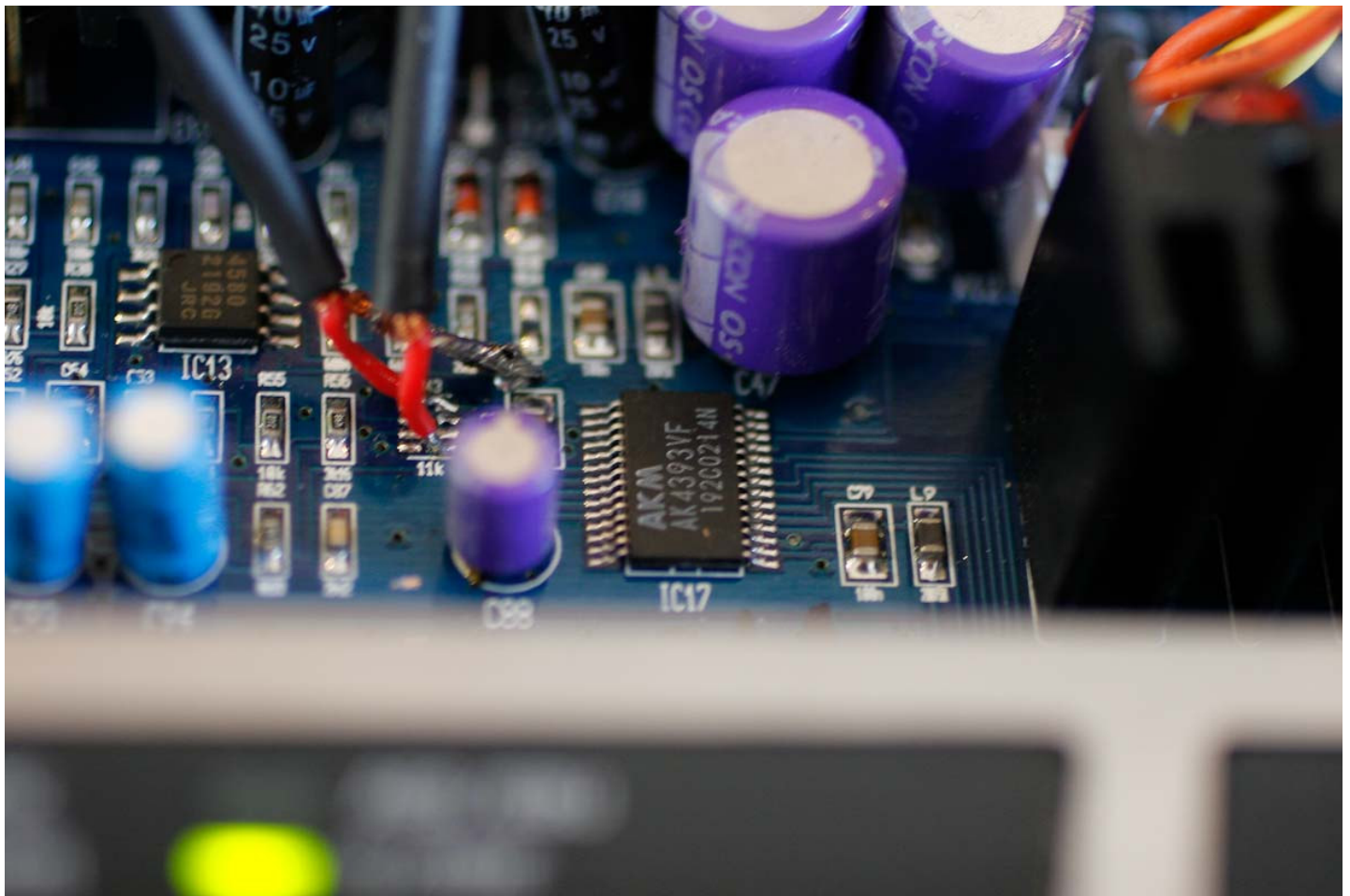





ERROR: ioerror  
OFFENDING COMMAND: image

STACK: