

7/2/1971 FEB 9 1971

- NEW RELEASE
- REPRINT RELEASE WITH NO CHANGES
- REPRINT RELEASE WITH CHANGES



OPERATING INSTRUCTIONS

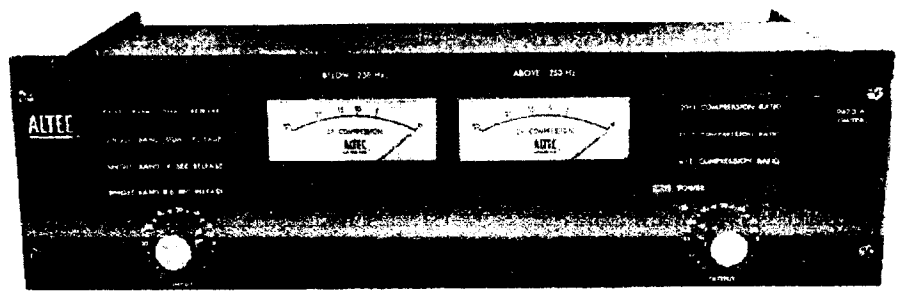

Figure 1. 9473A Limiter Amplifier

SPECIFICATIONS

Type:	Limiter Amplifier
Gain:	±1 dB
Frequency Response:	20 - 20,000 Hz
Power Output:	+24 dBm maximum output level
Distortion:	Less than 1% at 20 dB compression 32 Hz to 20 KHz (Typical 0.5%)
Noise Level:	74 dB below rated output
Source Impedance:	150 or 600 ohms
Load Impedance:	150 or 600 ohms
Maximum Compression:	40 dB
Attack Time:	10 μs
Release Time:	0.4 sec. above 250 Hz, 3.6 sec. below 250 Hz
	OR 0.4 sec. Single Band
	OR 3.6 sec. Single Band
	OR Dual Release as a function of controlling frequency
Threshold:	+15 dBm with output level control at maximum
Compression Ratio:	Selectable 4:1, 12:1, or 20:1
Controls:	INPUT Level Control, 20 step attenuator 2 dB/step OUTPUT Level Control, 20 step attenuator 2 dB/step Dual Band Dual Release Single Band Dual Release Single Band 0.4 sec. Release Single Band 3.6 sec. Release Compression Ratio Interlocked 20:1, 12:1, 4:1 POWER SWITCH
Power Supply:	120/240V ac 50/60 Hz at 15 watts
Dimensions:	5-1/4" H x 19" W x 7-5/16" D
Color:	ALTEC Green
Weight:	14 pounds

DESCRIPTION

The ALTEC 9473A Limiter Amplifier, designed primarily for recording studios, characterizes the concept of spectral separation, through the technique of an internal crossover network. The classical problems of envelope distortion caused by too short a release time and loss of program following a high energy peak when release time is too long are eliminated. A solid-state, 100% silicon transistor amplifier, the ALTEC 9473A, separates the incoming program material into two bands, each band controlled by a separate limiter circuit. The distortion figure, allowable at the lowest frequency of that band determines the release time, from 250 Hz up at 0.4 seconds, or below 250 Hz at 3.6 seconds. The ALTEC 9473A Limiter Amplifier utilizes two front panel meters to indicate dB of compression within the respective frequency spectrum. The use of an insulated gate Field Effect Transistor, provides instantaneous attack with no thump or overshoot.

The Dual Band Dual Release position operates on each band separately, compression in one band not affecting the other.

The Single Band Dual Release position control voltages are slaved together, with the largest signal controlling both sides. In this mode, the ALTEC 9473A is a standard wideband compressor with the added advantage of allowing the release time to vary from 0.4 seconds to 3.6 seconds, as a function of the frequency of the largest signal present. For example, high frequency passages may be severely compressed by peaks with a rapid release thus eliminating prolonged loss of audio, while low frequency passages are released slowly to eliminate envelope distortion.

Two ALTEC 9473A Limiters provide stereo control in all modes of operation for both high and low frequency bands, via 'stereo interconnect' jacks on the rear panel. When connected for stereo operation, compression in either ALTEC 9473A Limiter.

Specifications and components subject to change without notice. Overall performance will be maintained or improved.



will cause a corresponding degree of compression in the other, thereby maintaining channel gain balance. Well positioned controls provide unobstructed vision for ease of operation, and a hinged front panel facilitates servicing.

INSTALLATION

The ALTEC 9473A Limiter Amplifier will flush mount into any standard 19" rack or cabinet rack and requires only three vertical mounting spaces (5-1/4") and is 7-3/16" deep.

A screw type terminal block is provided at the rear of the chassis for input and output connections. Stereo control in all modes of operation for high and low frequency bands are provided via the stereo interconnect jacks also on the rear of the chassis.

Terminals 6, 7, 8, and 9, located on the input side of the terminal strip provide proper termination for 150 or 600 ohm driving source. Strapping combinations and input connections are diagrammed in Figure 3.

Terminals 1, 2, 3, and 4 on the output terminal strip are for loads of 150 or 600 ohms. Proper strapping combinations and output connections are diagrammed in Figure 3.

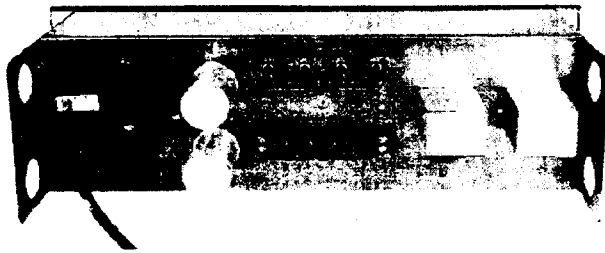

Figure 2. Rear View 9473A Limiter Amplifier

APPLICATION

The ALTEC 9473A Limiter Amplifier is intended for use in automatic level control applications fulfilling the requirements of professional broadcast, recording and motion picture industries. Figures 4 and 5, illustrate two of several system arrangements.

Figure 4 illustrates the use of the 9473A Limiter Amplifier in controlling peak levels from live recording microphones in a typical recording studio application, eliminating system overdrive in the tape recording unit.

Figure 5 illustrates the 9473A Limiter Amplifier used in a typical broadcast studio application to peak limit the signal from the program mixing console prior to distribution to the transmitter modulator. This allows the station to operate with high modulation efficiency while preventing over modulation. The 9473A Limiter Amplifier provides an output of +24 dBm for driving remote lines to the modulator.

OPERATION AND USE OF CONTROLS

The input level control is used to adjust degrees of limiting with varying input levels. With the control in the fully clockwise position (0), limiting takes place with an input of -35.

The input level required to reach limiting threshold increases 2 dB for every counterclockwise position of the input level control to a maximum of 40 dB, i.e.; an input of +5 dBm. The output level control adjusts the output from the limiter over a 40 dB range. With the output level control set fully clockwise (0), an input signal causing threshold, produces an output of +15 dBm. This output may be reduced 2 dB per counterclockwise step of the output level control for a maximum of 40 dB, i.e.; -25 dBm output at threshold.

COMPRESSION AND RATIO CONTROLS

The 20:1, 12:1 and 4:1 compression ratio controls are used to change the transfer slope of the limiter above limiting threshold. In the 20:1 position a 20 dB increase in the input level above threshold causes only 1 dB increase in the output. The slope is 12:1 or 4:1 in the other two positions, respectively.

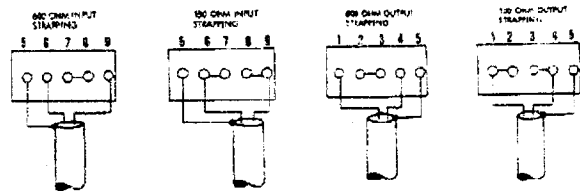

Figure 3. Input and Output Strappings

SINGLE AND DUAL BAND RELEASE FUNCTIONS

In the Dual Band, Dual Release position, the limiter operates on each band separately, compression in one band not affecting the other.

In the Single Band, Dual Release position, the control voltages are slaved together with the largest signal controlling both sides. In this mode the limiter is a standard wideband compressor with release time varying from 0.4 seconds to 3.6 seconds, as a function of the frequency of the largest signal present.

In the Single Band 0.4 second release or Single Band 3.6 release positions the limiter operates as a standard wideband limiter, with a release time of 0.4 seconds or 3.6 seconds, respectively.

CALIBRATION PROCEDURE

1. See Figure 6 for location of controls and direction of rotation. The arrows indicate the direction of rotation toward maximum on each control.
2. Set HIGH and LOW BAND LINEARITY controls to their MIN. positions.
3. Set HIGH and LOW BAND SENSITIVITY controls to their MID. positions.
4. Set HIGH and LOW BAND THRESHOLD controls to their MIN. positions.
5. Set INPUT level control to "0".
6. Set OUTPUT level control to "12".
7. Push the 12:1 COMPRESSION RATIO selector switch.
8. Simultaneously press the DUAL BAND DUAL RELEASE and SINGLE BAND 0.4 SEC. RELEASE buttons, thereby locking both down. Jumper point A. to point B. (See Figure 9 for location).

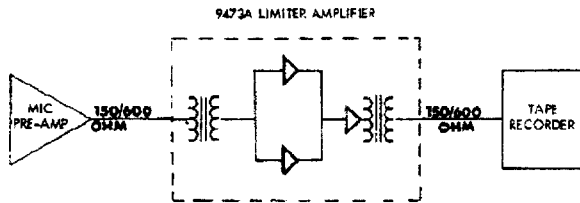

Figure 4. Typical Recording Studio Application

9. Apply 117V ac power to the unit and press the POWER switch "ON".
10. Apply a 1 KHz input signal of -36 dBm to the input terminals.
11. While observing the output on the oscilloscope, increase the HIGH BAND LINEARITY control toward maximum until the output wave form just starts to decrease. Any further increase would cause a definite reduction in the level of the output wave form.
12. Repeat Step 11, but this time adjust the LOW BAND LINEARITY control for the start of wave form amplitude reduction.
13. With the -36 dBm signal still applied to the input terminals, increase both the HIGH BAND and LOW BAND THRESHOLD adjustments until their respective meters just start to indicate to the left. The reaction to this adjustment may be slow and overshoot is common. If overshoot results and the meters peg to the left, slowly back the threshold controls down until the meters just indicate "0".
14. From the -36 dB input level, slowly increase the input level until one or both meters just start to indicate. If one meter starts to indicate first, back off on its threshold control while still increasing the input level, until both meters just start to indicate at the same input, i.e., threshold \approx -35 dB.

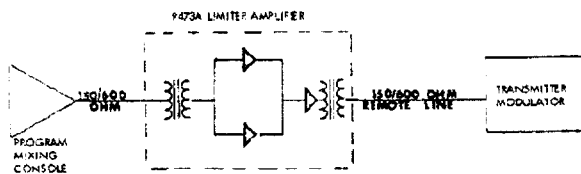

Figure 5. Typical Broadcast Studio Application

15. From the threshold level established in Step 14, advance the input level by 22 dB.
16. Simultaneously press the SINGLE BAND 0.4 SEC. RELEASE and SINGLE BAND DUAL RELEASE buttons, thereby locking both down.
17. Adjust both the HIGH BAND and LOW BAND SENSITIVITY controls for a reading of 20 dB on their respective meters.
18. Simultaneously press the DUAL BAND DUAL RELEASE and SINGLE BAND 0.4 SEC. RELEASE buttons, thereby locking both down.
19. Drop the input level by 11 dB and adjust the HIGH BAND and LOW BAND LINEARITY controls for a reading of 10 dB on their respective meters.

20. Increase the input level by 11 dB and repeat the Step 16 through 20 sequence as necessary.
21. Recheck Step 14 to ± 1 dB. If readjustment of either threshold control is required, recheck steps 15-20 also.
22. Remove jumper from point A and B. (See Figure 9).
23. Press front panel POWER switch to "OFF" and remove line cord plug from 120V supply.

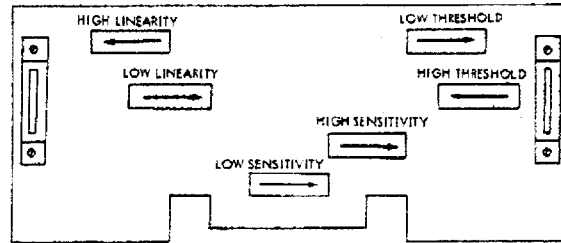

Figure 6. Location of Calibration Controls

STEREO OPERATION

Two ALTEC 9473A Limiter Amplifiers provide stereo control in all modes of operation for both high and low frequency bands. When connected for stereo operation, compression in either ALTEC 9473A Limiter, will cause a corresponding degree of compression in the other, thereby maintaining channel gain balance. Multiple jacks are provided for each band to allow paralleling additional limiter amplifiers. Figure 7 illustrates stereo interconnection.

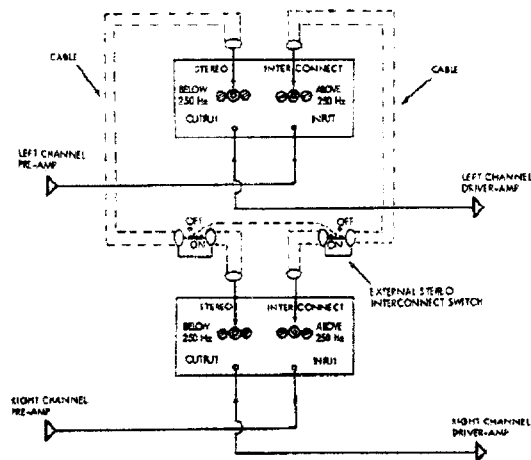

Figure 7. Stereo Interconnect

SERVICING

All circuit components are easily reached by opening the hinged front panel of the unit. Normal servicing may be done with a voltmeter. All pertinent information is shown on the schematic, Figure 10.

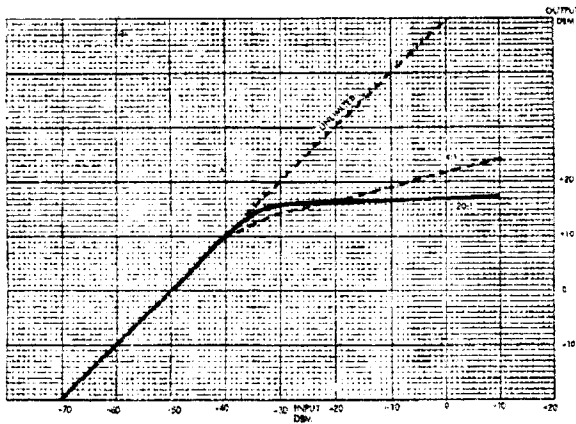

Figure 8. Typical Limiter Characteristics

PARTS LIST

Reference Designator	Ordering Number	Name and Description
C1	15-01-108579-01	Cap., 50 μ F 30V
C2,25,32,33,34	15-06-107426-01	Cap., 1 μ F \pm 10%, 50V
C3,4	15-06-100111-01	Cap., 0.1 μ F \pm 10%, 100V
C5,6	15-06-051240-02	Cap., 0.025 μ F \pm 5%, 100V
C7,8,11,20	15-01-107343-01	Cap., 25 μ F 25V
C9,10	15-01-106218-01	Cap., 10 μ F 15V
C12,13	15-01-108630-01	Cap., 200 μ F 15V
C14,15,36,37	15-02-108584-01	Cap., 10 μ F 30V
C21	15-06-106204-01	Cap., 0.047 μ F \pm 10%, 100V
C22	15-06-108629-01	Cap., 0.47 μ F \pm 10%, 100V
C23	15-01-108580-01	Cap., 25 μ F 6V
C26	15-01-107523-01	Cap., 50 μ F 15V
C27	15-01-100255-01	Cap., 100 μ F 20V
C28,29	15-01-108581-01	Cap., 50 μ F 50V
C30,31	15-01-108578-01	Cap., 3100 μ F 40V
C35	15-02-107455-01	Cap., 47 μ F \pm 10%, 100V
CR1	48-01-108576-01	Diode, Zener \pm 15%, 5V
CR2,3,4,5,6,7	48-01-102592-01	Diode
CR8	48-01-108575-01	Diode, Zener 30V 5%
CR9	48-01-109738-01	Diode, Zener 27V \pm 10%
CR10,11,13,14	48-01-107017-01	Diode, 1N456A
CR12	48-02-108577-01	Diode, Rectifier, SC8R-1
F1	51-04-100464-01	Fuse, 1A 3AG
M1,2	29-01-041819-01	Meter
Q1,2,3	48-03-107318-01	Transistor, 2N5308
Q4,5	48-03-108573-01	Transistor, MFE3002
Q6,7,8,9,14,15,16,17,21,24	48-03-041440-01	Transistor
Q10,11,12,13,20	48-03-101098-01	Transistor (AL2712)
Q18,19	48-03-108574-01	Transistor, 2N4530
Q22	48-03-040461-02	Transistor
Q23	48-03-101111-01	Transistor, 2N4036
R1,73	10-05-26-487	Attenuator, 25K
R2,64	47-01-104541-01	Res., 330K Ω \pm 5%, 1/4W

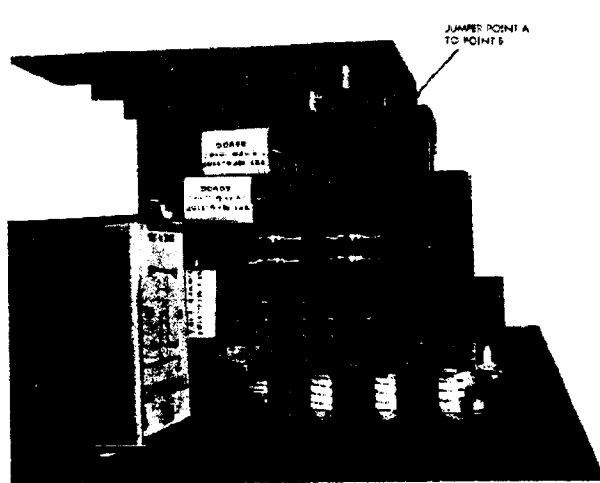

Figure 9. Input Switchboard Assembly

PARTS LIST (Continued)

Reference Designator	Ordering Number	Name and Description
R3,10,32,33,44,45,46,48,76,77,78,87,88	47-01-102127-01	Res., 100K Ω \pm 5%, 1/4W
R4,5	47-01-102086-01	Res., 2.2K Ω \pm 5%, 1/4W
R6,8	47-01-102097-01	Res., 6.2K Ω \pm 5%, 1/4W
R7	47-01-102112-01	Res., 27K Ω \pm 5%, 1/4W
R9,57,60	47-01-102082-01	Res., 1.5K Ω \pm 5%, 1/4W
R11	47-01-102115-01	Res., 36K Ω \pm 5%, 1/4W
R12,13,42,43	47-01-102094-01	Res., 47K Ω \pm 5%, 1/4W
R14,16,34,35	47-01-102100-01	Res., 8.2K Ω \pm 5%, 1/4W
R16,17,52,54,56,59	47-05-100813-01	Potentiometer, 10K Ω
R18,19,22,23,40,41,55,53,67,69,83,84	47-01-102102-01	Res., 10K Ω \pm 5%, 1/4W
R20,21,24,25,26,27	47-01-102110-01	Res., 22K Ω \pm 5%, 1/4W
R28,29,49,50	47-01-102114-01	Res., 33K Ω \pm 5%, 1/4W
R30,31	47-01-102066-01	Res., 330 Ω \pm 5%, 1/4W
R36,37,62,75,80,81	47-01-102078-01	Res., 1K Ω \pm 5%, 1/4W
R38,39	47-01-102099-01	Res., 7.5K Ω \pm 5%, 1/4W
R51,53	47-01-108586-01	Res., 8.2M Ω \pm 5%, 1/4W
R56,61,70	47-01-102090-01	Res., 3.3K Ω \pm 5%, 1/4W
R65	47-01-102131-01	Res., 150K Ω \pm 5%, 1/4W
R66,68	47-01-102098-01	Res., 6.8K Ω \pm 5%, 1/4W
R71,72	47-01-102030-01	Res., 10 Ω \pm 5%, 1/4W
R74,75	47-01-102346-01	Res., 330 Ω \pm 10%, 1/4W
R82	47-01-102073-01	Res., 620 Ω \pm 5%, 1/4W
R85,86	47-01-102038-01	Res., 22 Ω \pm 5%, 1/4W
R89	47-01-102351-01	Res., 470 Ω \pm 10%, 1/2W
S1	51-02-108588-01	Switch assembly
S2	51-02-108589-01	Switch assembly
T1	56-04-004833-01	Transformer, input
T2	56-08-007379-01	Transformer, power
T3	56-07-015298-01	Transformer, output

