

SERVICE MANUAL

MODEL

B - 3

C - 3

ORGANS

WITH

MODEL

PR-40

STONE

CABINET



HAMMOND ORGAN COMPANY
DIVISION OF HAMMOND CORPORATION

1740 N. 25th Avenue • Melrose Park, Ill. 60160

SPECIAL NOTE

In the text of this manual, reference is made to the C-3 Model instrument. Since the B-3 is for all purposes identical as to components, except for cabinet style, this manual and parts list can suffice for B-3 and C-3.

TABLE OF CONTENTS

Section	Page
I INTRODUCTION AND DESCRIPTION	1-2
1-1. Introduction	1-2
1-3. Description	1-2
II PRE-REPAIR PROCEDURES	2-1
2-1. Power Requirements	2-1
2-3. Inspecting, Stripping, Cleaning, and Lubrication	2-1
2-30. Inspecting and Testing Removed Parts	2-2
III TROUBLE LOCATION	3-1
3-1. Trouble Shooting	3-1
3-7. Sectionalizing Trouble	3-3
3-12. Locating and Correcting Defective Individual Tones	3-3
3-27. Trouble Shooting Chart	3-8
IV ALIGNMENT PROCEDURES	4-2
4-1. Preset Panel Tone Selection	4-2
4-5. Alignment of Coil Assemblies	4-2
4-9. Adjustment of Intermittent or Non-operating Keys	4-4
V STAGE DATA AND FINAL TESTING	5-1
5-1. Detailed Theory of Operation	5-1
5-62. Replacement of Components	5-9
VI RECOMMENDED SPARE PARTS	6-1
6-1 General	6-1
6-2 Repair Parts List, Illustrated	6-1
Parts Illustrations	6-11
APPENDIX A	A-1
Cross Reference Index, New Hammond Part Numbers to Old	
APPENDIX B	B-1
Cross Reference Index, Old Hammond Part Numbers to New	



Figure 1-1A. Front View of B-3 Console



Figure 1-1B. Front View of C-3 Console

SECTION I

INTRODUCTION AND DESCRIPTION

1-1. INTRODUCTION.

1-2. This handbook contains instructions for the repair and maintenance of the Model C-3 Hammond Electric Organ with Model PR-40 Tone Cabinet.

1-3. DESCRIPTION.

1-4. GENERAL.

1-5. The Model C-3 Hammond Electric Organ is a complete organ system for the production of musical tones by electronic means. The organ consists primarily of a tone cabinet (which includes 1 power amplifier and 4 speakers), a console, and connecting cords and cables. The organ is a movable unit which fits into a space approximately 4 feet square, and operates from a standard 60-cycle, 117 volt power source. A 50-cycle 234-volt model is also available. (See figure 1-1.)

1-6. DETAILED.

1-7. **CONSOLE.** The console contains the playing and tone control mechanism of the organ and is provided with a bench and removable pedal clavier. Upper and lower manuals (keyboards played with the hands) are located under the folding-type keyboard cover on two levels, one above the other. (See figure 1-1.) Each manual consists principally of 61 playing keys,

9 preset keys, and 2 adjust keys which connect the manual to the harmonic drawbars. The preset and adjust keys, located at the extreme left end of the manual, are the same size and shape as the playing keys, but they are reversed in color. The preset keys provide frequently used tone colors (flute, French horn, diapason, etc.) which can be permanently set on the organ. Four groups of 9 harmonic drawbars each are located above the upper manual and are used to set up tone colors other than those provided by the preset keys. On each drawbar (a small metal strip) are marked eight graduations of strength, the fully closed bar giving a ninth silent position. The harmonic drawbars are connected to the manuals by the adjust keys, A# and B. Two brown knobs are located in the center of the row of harmonic drawbars and spaced apart from them. These are pedal drawbars and are used to select the tone to be used in the pedal notes. The "START" and "RUN" switches, and 4 Percussion tablets, are located to the right of the harmonic drawbars; the vibrato controls are located to the left of them. The console is provided with a 15-foot, 2-conductor power cord to connect it to the AC (alternating-current) power source. A 35-foot, 5-conductor cable with a 6-prong female connector receptacle is provided for connection to the tone cabinet.

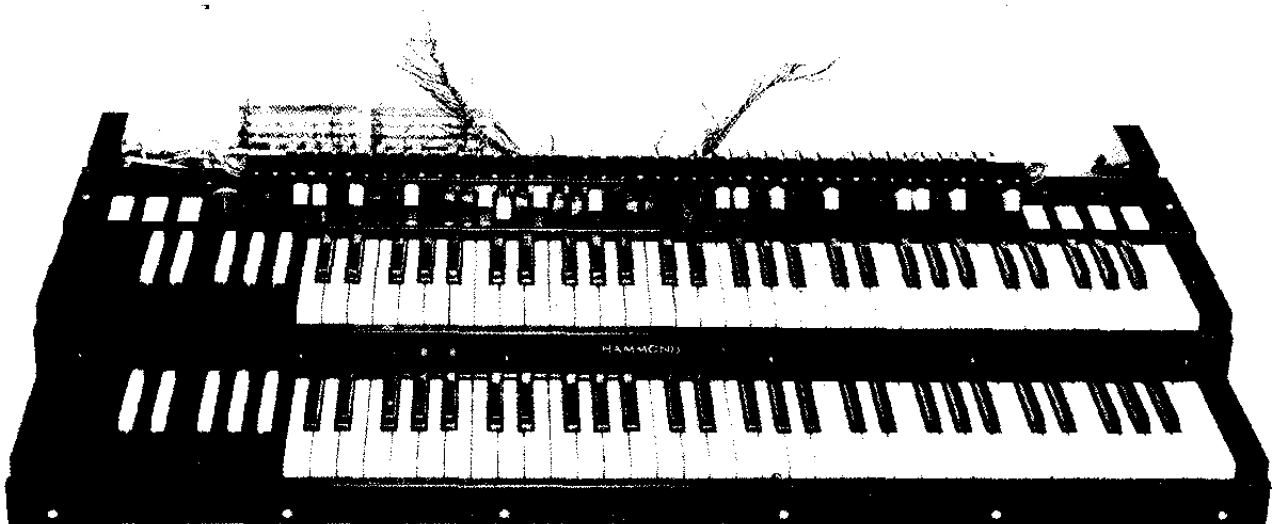

Figure 1-1. Manual Chassis Assembly

1-8. **PEDAL CLAVIER.** The detachable pedal clavier, which controls suboctave tones of the manuals, is a keyboard of natural and sharp keys played with the feet. The clavier is composed principally of a series of 25 levers. Flat springs (switch pushers) on the ends of the pedals depress small plungers that in turn actuate the pedal switch. (See figure 1-3.)

1-10. **TONE GENERATOR ASSEMBLY.** A removable rear panel, secured by two knurled screws at the back of the console, provides access to the tone generator assembly and to the console preamplifier chassis. (See figure 1-4.) The tone generator assembly consists of the generator proper, a shaded-pole induction motor for starting, a synchronous run motor for

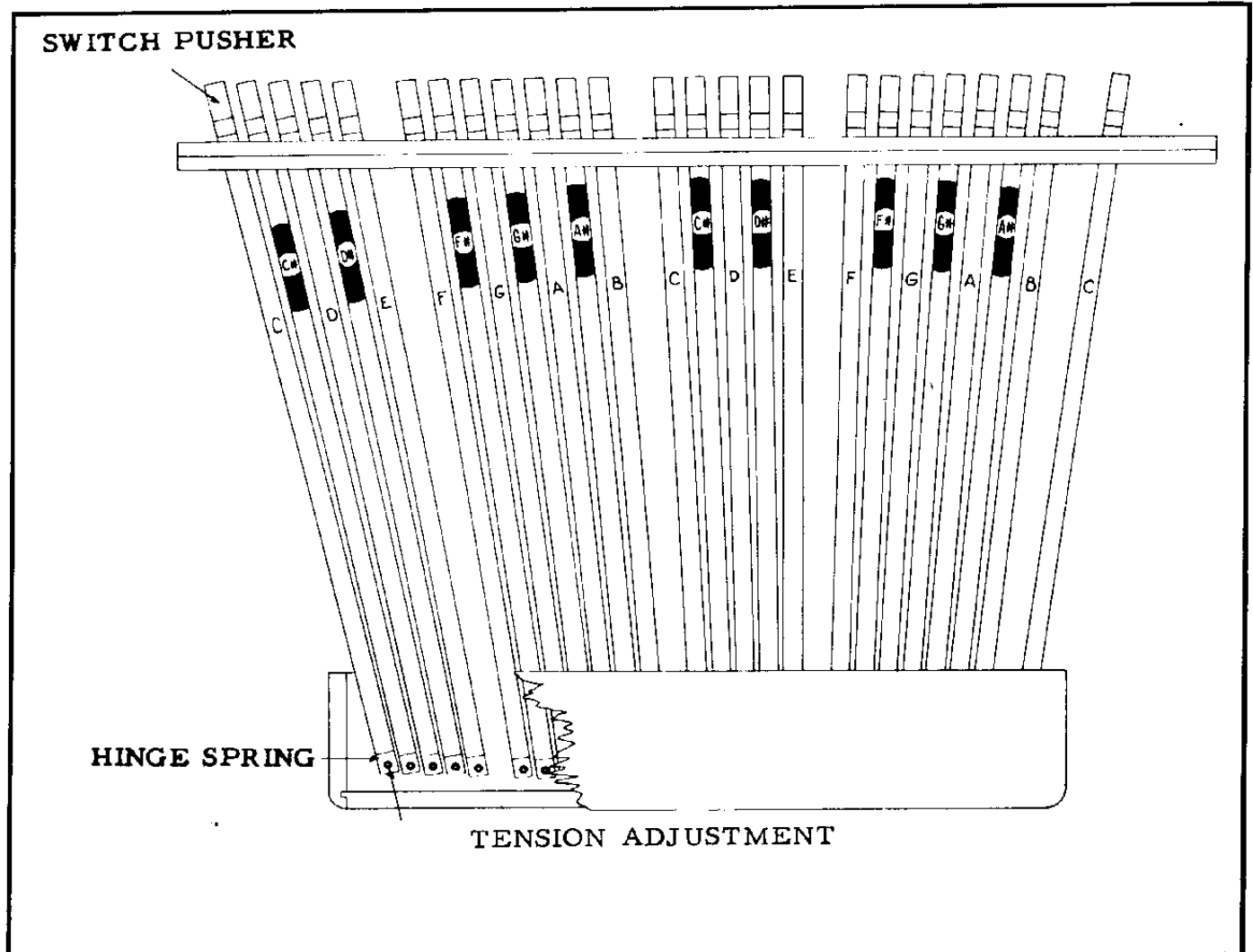

Figure 1-3. Pedal Keyboard

1-9. **SWELL OR EXPRESSION PEDAL.** This pedal controls the volume of sound produced by any tonality or tonal combination brought into play on both manuals and on the pedals. The swell pedal is located above the pedal clavier and is connected, through a crank and hinge assembly and lever arm, to the volume control assembly, located near the center of the console. (See figure 1-4.) A "Volume Soft" tablet supplements the swell pedal by reducing the volume of the entire organ. It is useful for playing softly without losing the full dynamic range of the swell pedal.

driving the unit after it is started, and a vibrato mechanism mounted on the run motor. The generator houses the various tone wheels, magnets and coils, filters, and driving gears. (See figure 1-5.) The entire assembly is mounted on 2 long steel angles which are suspended from the console by 4 springs. The shaded-pole induction-start motor is located at the right end of the generator (looking at it from the rear of the console); the synchronous run motor is located to the left of the generator, behind the power terminal panel.

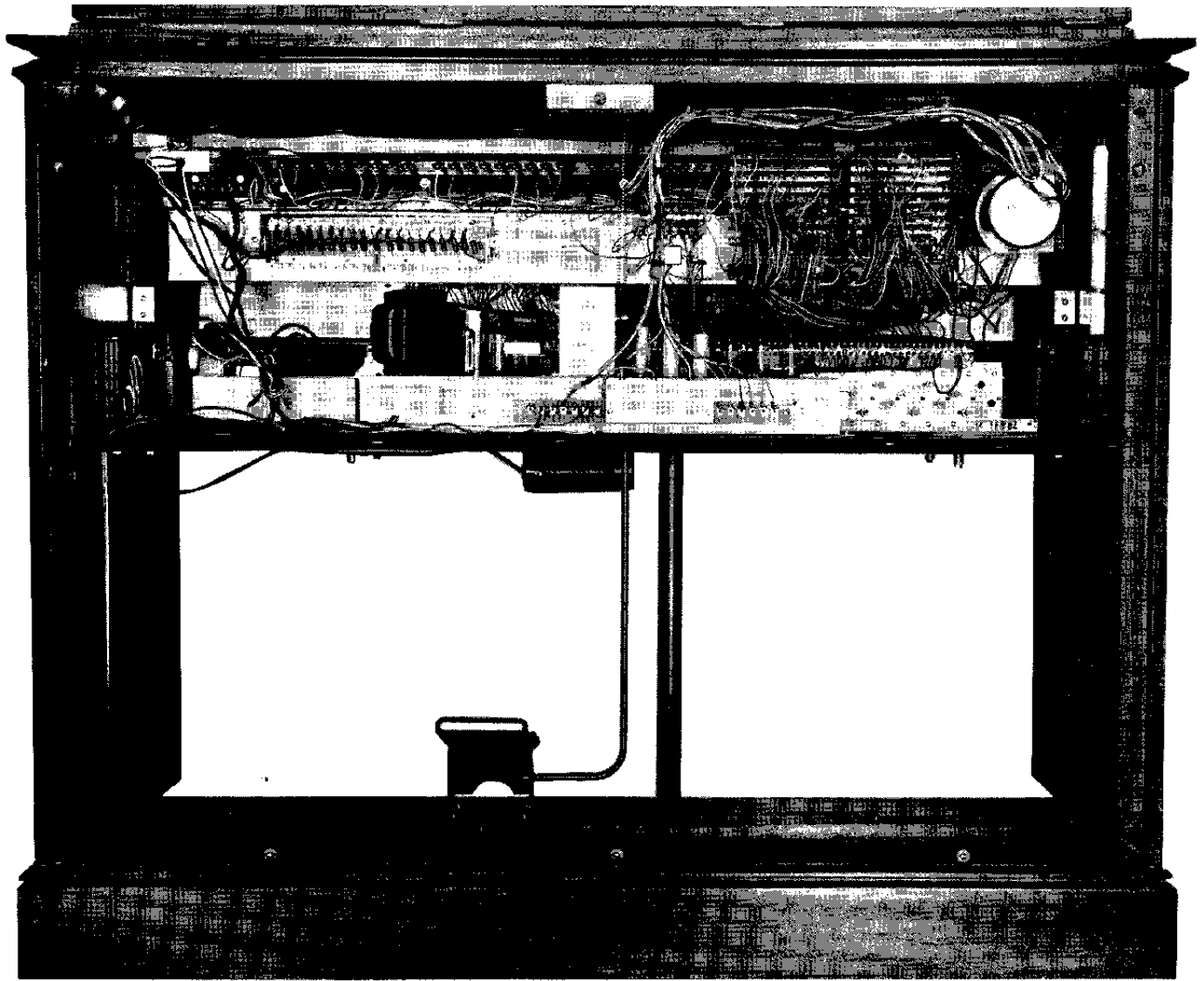

Figure 1-4. Rear View of Console

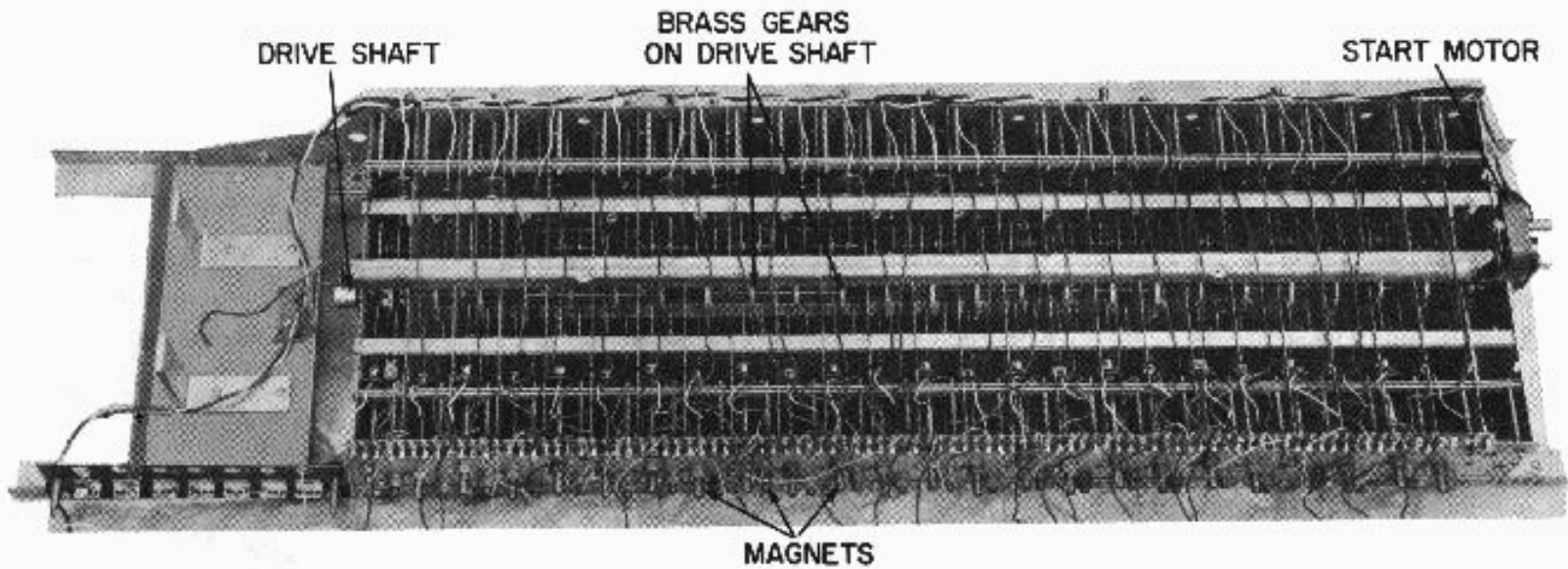

Figure 1-5. Tone Generator

1-11. **VIBRATO SYSTEM.** This portion of the organ consists of the "VIBRATO-VIBRATO CHORUS" switch and vibrato "OFF-ON" tablets shown in figure 1-2, a line box, and a scanner which is part of the run motor assembly attached to the generator. The purpose of this device is to add warmth to the music; this is accomplished by varying the pitch of each note played.

1-12. **PERCUSSION SYSTEM.** This system includes four control tablets (See figure 1-2) and circuitry in the preamplifier chassis, by which tones are caused to sound quickly and then fade away.

1-13. **MANUAL CHASSIS ASSEMBLY.** This assembly has a terminal strip under each manual with 79 terminals to accommodate the frequencies from the tone generator. Each of the playing keys operates nine small bronze contact springs with palladium alloy points. The contact springs of the playing keys are connected through resistance wires to the proper terminals on the terminal strips. The palladium alloy points make contact with nine bus bars which extend the entire length of manual. The contact surface of the bus bars is precious metal (palladium), and the body of the bus bars is nickel steel. (See figure 1-6.)

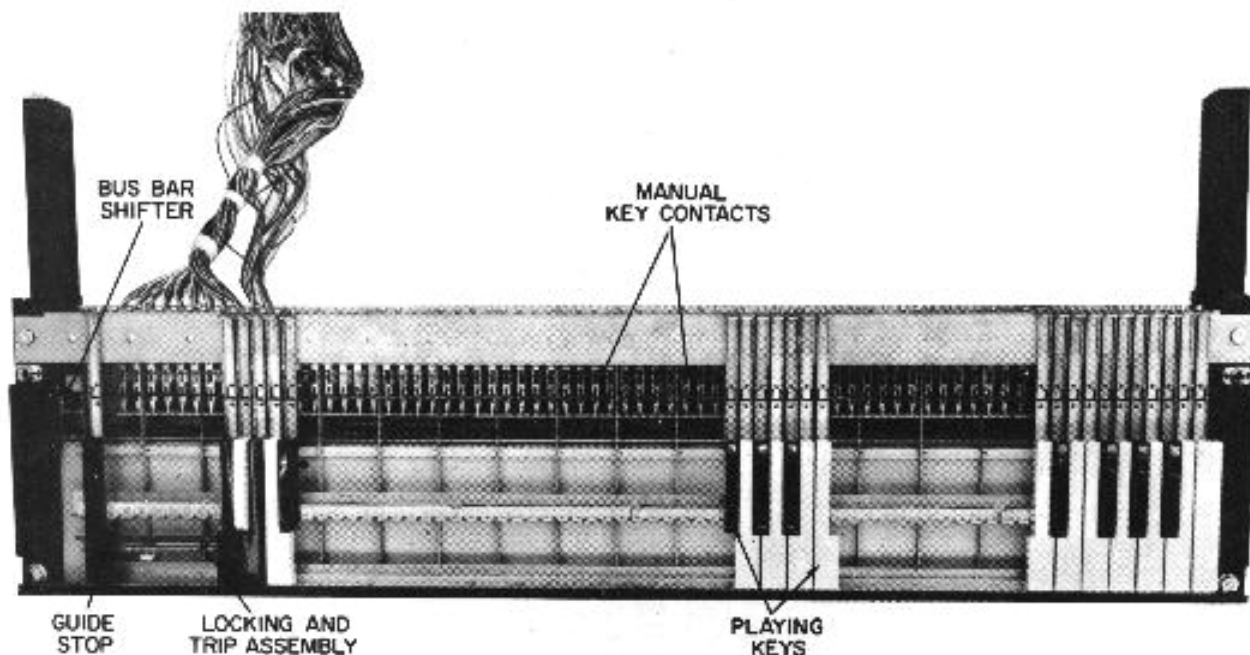

Figure 1-6. Manual Chassis Partially Disassembled

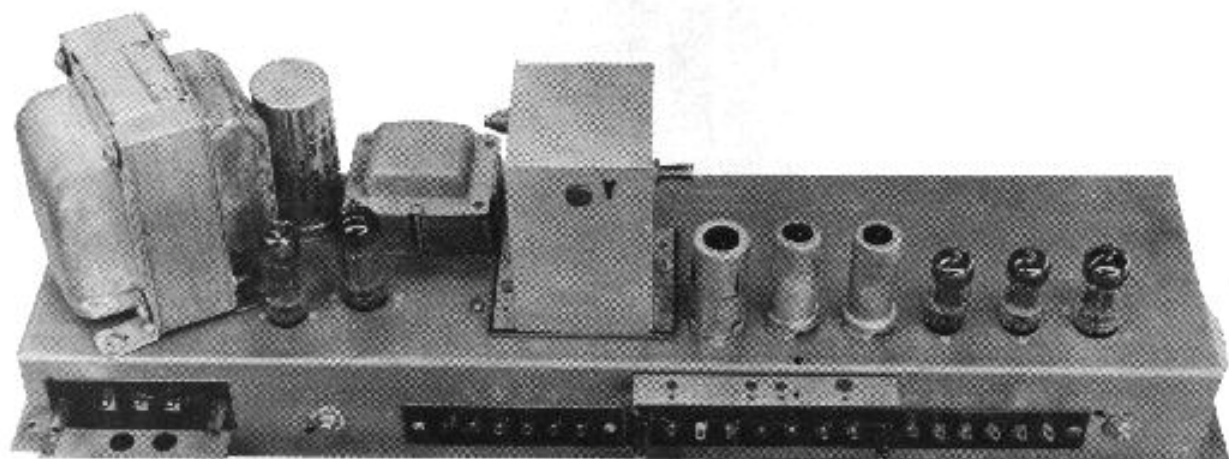

Figure 1-7. Preamplifier

1-14. **CONSOLE PREAMPLIFIER.** This is a Class "A" type preamplifier which initially amplifies the electrical impulses that originate in the generators. Input connections from the mixing transformer are made with shielded wires. A terminal panel is provided for all external connections. The output of the preamplifier is connected to the tone cabinet through suitable cabling. (See figure 1-7.)

1-15. **TONE CABINET.** This should be placed at least several feet from the console. It contains the power amplifier, a power supply unit, 4 speakers, and a reverberation unit. (See figure 1-8.)

1-16. **POWER AMPLIFIER.** This is a Class "A" type amplifier with fixed bias. It has 3 output channels. The treble direct channel drives a 12" speaker facing upward and handles non-reverberated tones above 200 cycles. The treble reverberation channel drives a 12" speaker and handles reverberated tones above 200 cycles. The bass channel drives 2-12" speakers and handles tones below 200 cycles. (See figure 1-9.)

1-17. **REVERBERATION UNIT.** This is an electro-mechanical device which simulates the multiple echoing of sound in a large room. It consists of several coil springs through which the musical tones are transmitted mechanically. A driving coil at one end actuates the springs, and the delayed tones are picked up by a coil at the other end. (See figure 1-10.)

1-18. **OVERALL THEORY OF OPERATION.**

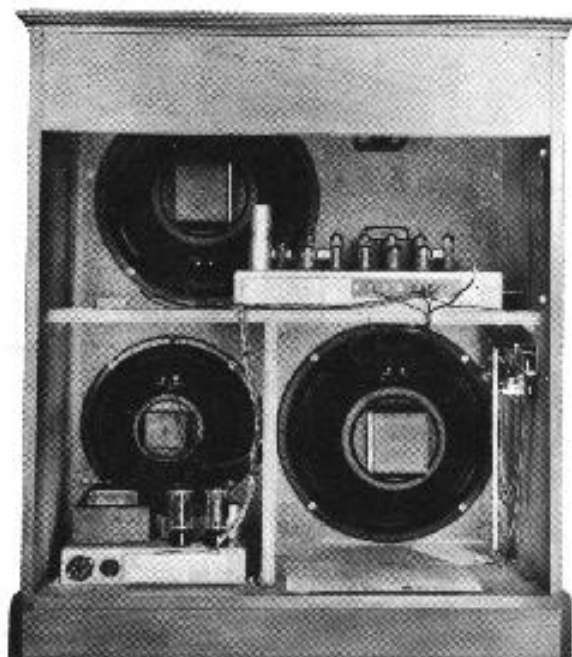

Figure 1-8. PR-40 Tone Cabinet, Rear View

1-19. In the Model C-3 Hammond Organ, voltages are generated by tone wheels and are then amplified and converted into sound. A separate tone wheel is provided for each frequency used in the organ. All the tone wheels are geared together in a tone generator assembly and are driven by a constant speed synchronous motor.

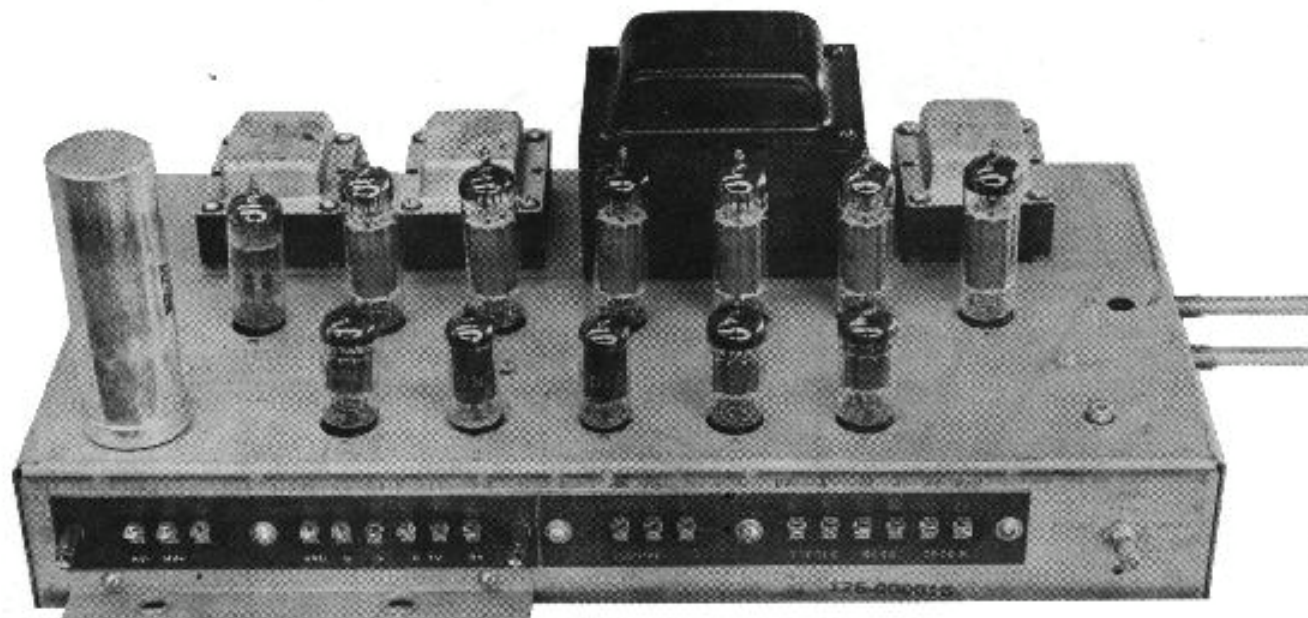

Figure 1-9. Power Amplifier

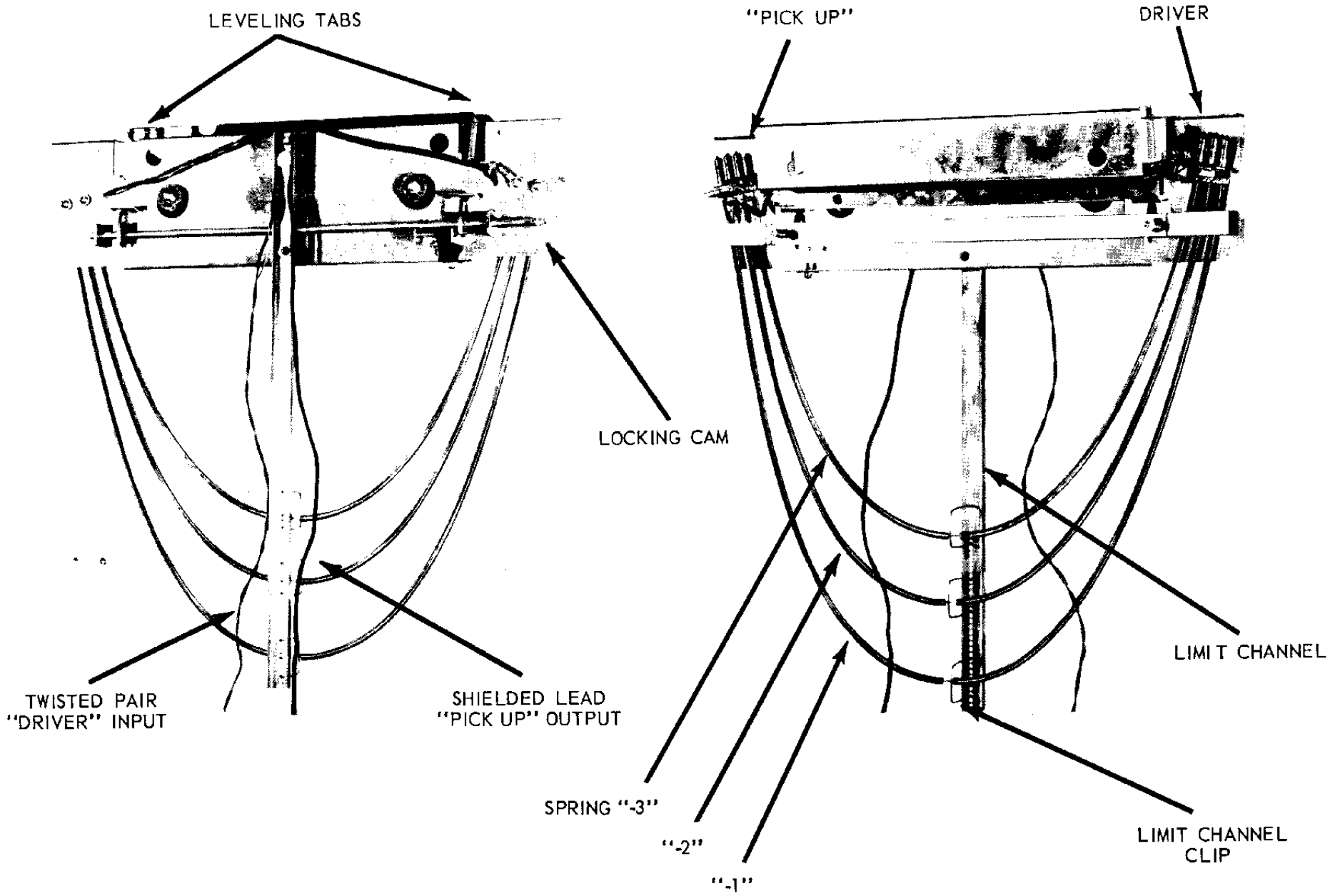

Figure 1-10. Reverb Unit

Filters, consisting of small reactors and capacitors associated with certain frequencies, are used to eliminate undesirable harmonics that may be present.

1-20. Each playing key carries the fundamental note and its eight harmonics. When a playing key is depressed, its 9 frequencies are impressed on the 9 bus bars of the manual. A preset key, when depressed, completes the circuit to the mixing transformer. The preset keys enable a series of previously set-up tonalities and tonal combinations to be available immediately on the two manuals without the use of the drawbars. The preset keys are wired to the preset panel. Flexible leads carrying the various harmonics from the preset keys are connected to the desired taps on the mixing transformers. The adjust keys connect the manuals to the harmonic drawbars, which are then wired to the same input taps of the mixing transformers as the preset panel. The harmonic drawbars provide a means for combining the simple tones which add up to the complex tones (mixture of fundamentals and harmonics). These drawbars enable the

organist to select and regulate the desired harmonics of certain strengths to achieve various tones and shades of tones.

1-21. The Swell or expression pedal, controls the volume of any tone (or tonal combination) that may be brought into play on both manuals and pedals. The volume increases as the swell pedal is depressed.

1-22. The "VIBRATO" and "VIBRATO CHORUS" switches permit the introduction of the vibrato effect to the music that is being played. Separate tablets located on the upper left-hand side of the keyboard permit the vibrato effect or vibrato chorus effect to be present on either manual independently at the wish of the player. This vibrato effect will also be present on the pedals whenever the vibrato tablet of the lower manual is pressed to the "ON" position.

1-23. The console preamplifier is a straight Class "A" type amplifier. The output of the preamplifier is fed to the power amplifier, located in the tone cabinet.

SECTION II

PRE-REPAIR PROCEDURES

2-1. POWER REQUIREMENTS.

2-2. POWER SOURCE. For operation, operational tests, and repair procedures, the Model C-3 Hammond Organ requires connection to a standard 60-cycle, 117-volt (or 50-cycle, 234 volt) power source.

2-3. INSPECTING, STRIPPING, CLEANING, AND LUBRICATING.

2-4. OVERALL INSPECTION.

2-5. Rotate all controls and operate all switches. Pull out all drawbars. Operation should be smooth. Toggles should snap firmly into position. Depress the playing keys; check for proper tension in each case and for cracks and chips. Check the operation of the locking and trip mechanism by striking each preset and adjust key in turn. Be sure that the cancel key releases the associated preset or adjust key on each manual.

2-6. Check the mounting of the reverberation spring system assembly in the tone cabinet. Determine that the locking lever is in its unlocked position; if it is not, unlock as indicated on instruction card on tone cabinet.

2-7. Insert all connector plugs into their receptacles. Plugs should seat firmly and must make good contact. Inspect all connector plugs for loose prongs or pins. Examine all cords and cables for frayed insulation and defective wiring. Check for kinks, bends, or twists.

2-8. Inspect all parts and wiring for rust, corrosion, loose connections, frayed or burned insulation, loose mounting screws and bolts, and burned resistors and coils. Check and tighten all mechanical fasteners, such as screws and bolts. Make a thorough inspection of all tube sockets for broken contacts. Examine all switches for loose or bent contacts and for broken insulation. Inspect springs for proper tension. Be sure that each end of each spring is properly attached to the associated parts. Inspect for any broken parts, evidence of excessive heating and overloading, as indicated by burned resistors or melted wax. Look and smell for these latter troubles.

2-9. Examine all terminal strips, boards, and panels for defective wiring, broken lugs, loose contacts, and signs of burning. Be sure that all screws on the preset panel are securely tightened

in position and that all leads are held firmly in place.

2-10. Push down and raise the swell pedal, and note the action of the crank and hinge assembly. Tighten mounting screws where necessary.

2-11. Check the speaker cones for defects. Check the speaker mounting bolts for tightness.

2-12. Inspect all pedals on the pedal clavier for cracks or breaks and for proper tension. (Each pedal should just come up when a 3-pound weight is placed directly behind the pedal sharp cap.) Be sure that the flat spring pushers at the ends of the levers are firmly mounted and are properly seated in place over the pedal switches. (See figure 3-3.) Determine that the felt pad extending over all the plungers is in place and not worn. Adjustable tension springs are made accessible by removing the cover board from the rear of the pedal clavier. If pedals become loose and rebound when played rapidly, increase the tension by tightening the adjustment screws (See figure 1-3.).

2-13. Check the generator anchoring fittings. They should be unscrewed so that the generator floats freely. Be sure that all suspension springs for the generators are connected in position at both ends and are properly positioned.

2-14. Be sure that the console is located on a rigid level surface, so that the generator mounting mechanism, anchored to the generator frame, is free to move in any direction without coming in contact with the wooden shelf of the console bottom.

2-15. Be sure that the tone cabinet is located with the open back placed 2 inches or more from the wall or other obstruction. Be sure that adequate ventilation has been provided.

2-16. Check all tubes for cracks in glass or base, and for bent or broken prongs. Inspect for firm mounting of the tubes in their sockets. Test tubes for low emission, leakage, and short circuits. Test all tubes at least semi-annually, and replace them at least every 18 months. Inspect pins and bases for accumulations of foreign matter.

2-17. As the Model C-3 Hammond Organ is used in chapels and auditoriums, it is unlikely that inspection will find the organ deteriorated be-

yond repair, except where it has been subjected to fire or explosion.

2-18. REMOVAL AND REPLACEMENT OF PLUCK-OUT PARTS.

2-19. VACUUM TUBES. The following instructions apply when it is necessary to remove and replace vacuum tubes.

a. Table I lists the tube complement of the Model C-3 Hammond Organ and Model PR-40 Tone Cabinet.

TABLE I

Unit	Tube	Quantity	Unit	Tube	Quantity
Console Preamplifier	6AU6	2	Power Amplifier (in PR-40 Tone Cabinet)	5U4GB	2
	6C4	2		6AU6	2
	6X4	1		6BQ5	6
	12AU7	1		12AU7	1
	12AX7	1		12AX7	2
	12BH7	1		12BH7	1

b. Never remove tubes from the amplifiers when the organ is turned on. Avoid working on the tubes immediately after shut-down; severe burns may result from contact with the envelopes of hot tubes. Never jar a warm tube.

c. When replacing a defective tube, do not jiggle the tube from side to side in its socket. Movement of the tube weakens the pins in the base and unnecessarily spreads the contacts in the socket. Replace the defective tube; be sure that the replacement is pressed down firmly in its socket.

2-20. PEDAL CLAVIER. The following instructions apply when necessary to remove and replace the pedal clavier.

a. Remove the bench positioned over the pedal clavier.

b. Lift the console end of the pedal clavier and pull slightly up and out.

c. To replace the pedal clavier, place it in position, lifting slightly at the front, and slide it under the console until it locks in place. Place the bench in its proper position over the foot pedals.

2-21. CORDS AND CABLES. Disconnect cords and cables by firmly grasping the connector plug and pulling it.

2-22. CLEANING.

2-23. The following materials are required to perform cleaning operations on the Model C-3 Hammond Organ:

- a. Clean cloth.
- b. Dry-cleaning solvent.
- c. Paint brush with camel's hair bristles.
- d. Lint-free, bleached cloth.

- e. Compressed air.
- f. Crocus cloth.

2-24. Remove corrosion, rust, or dirt. Blow out dirt and dust from the interior of the console and the tone cabinet. If an air hose is used, be sure that any water which may have condensed in it is blown out before applying the air stream to the equipment. When using compressed air to remove dirt, be careful not to disturb the wiring. Scrape off tar or other adhering foreign matter;

touch up with paint or lacquer if necessary.

2-25. Clean the vacuum tube sockets and pin receptacles with solvent and a camel's hair brush. If necessary, clean pins with crocus cloth.

2-26. Clean all wooden parts and playing keys with a clean, lint-free cloth. Accumulations of dirt and dust in the key contacts may be removed by adjusting the bus bar shifters. (See paragraphs 4-9 to 4-13 inclusive.) No disassembly is required.

2-27. LUBRICATION

2-28. APPROVED LUBRICANTS. The following listed lubricating material is required to service the Model C-3 Hammond Organ.

Nomenclature	Stock No.	Class	Source
Lubricating Oil- Preservative, Special, Spec MIL-L-644	14-02834-10	06-B	AF Stock

2-29. CONSOLE. Some moving parts receive lubrication by capillary action via cotton threads connected to the central oil trough. Oil is fed to this trough from two oil cups. (See figure 2-1.) To gain access to these oil cups, remove the rear dust panel by unscrewing the two thumbscrew bolts. Every year fill the oil cups three-quarters full with oil, Spec MIL-L-644. (The oil level will slowly drop; however, do not continue adding oil.)

2-30. INSPECTING AND TESTING REMOVED PARTS.

2-31. VACUUM TUBES.

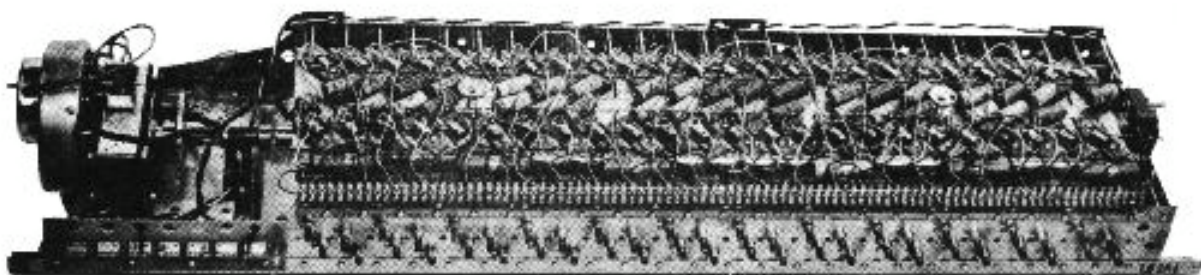

Figure 2-1. Tone Generator

2-32. **INSPECTING.** Check each tube for tight mounting in its socket. Inspect visually for mechanical and other obvious defects. Discard defective tubes. Be certain that each tube is of the type specified.

NOTE

Return each tube, if found to be good, to the socket from which it was removed. Distortion will result if replaced tubes are mismatched.

2-33. **TESTING.** Use tube checker in accordance with the instructions furnished. Do not neglect the short-circuiting test.

2-34. **CABLES AND CONNECTORS.**

2-35. **INSPECTING.** Inspect cables for cracked, frayed, or deteriorated insulation at the connecting or supporting points. Inspect the cables or connectors for improper placement which puts them under strain. Watch for kinks and improper supports. Inspect all connectors for dirt, corrosion, and damaged or loose contacts or terminals. To prevent possible short circuits, be sure no corrosion or dirt remains between the contacts.

2-36. **TESTING.** Use an ohmmeter and make continuity checks on the cables. Test for grounding and for shorting between points; if defects are discovered in connectors, replace the connectors. Test the voice coils. Reading of approximately 8 ohms should be obtained. (See figure 2-2.)

SECTION III

TROUBLE LOCATION

3-1. TROUBLESHOOTING.

3-2. GENERAL. When troubleshooting, use all of the aids included in this handbook: block diagram (figure 3-1), overall schematic (figure 3-3), amplifier schematic (figure 5-10), illustrations of components (figures 1-4, 1-5, and 3-2),

stage (as shown in schematic, figure 3-3). Make all capacitor checks with capacitor analyzer, if available. Always disconnect capacitors before making tests; otherwise the readings will be affected by a possible shunt circuit. Replace any capacitor which shows a deviation of 20 percent or more.

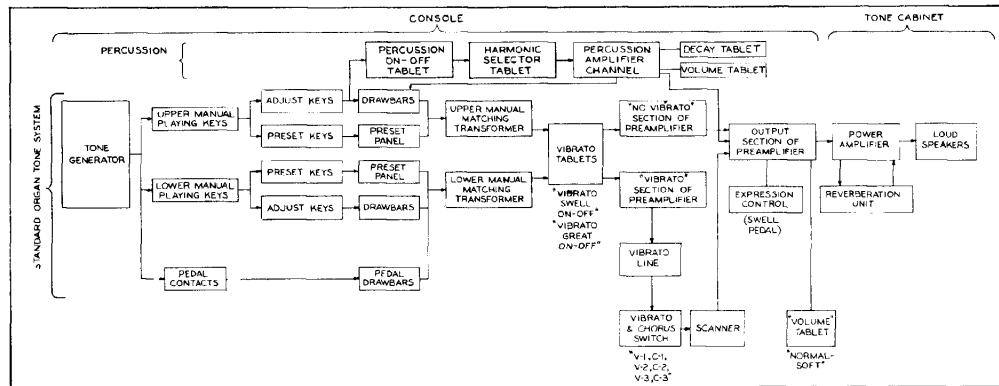

Figure 3-1. Block Diagram of C-3 Console with PR-40 Tone Cabinet

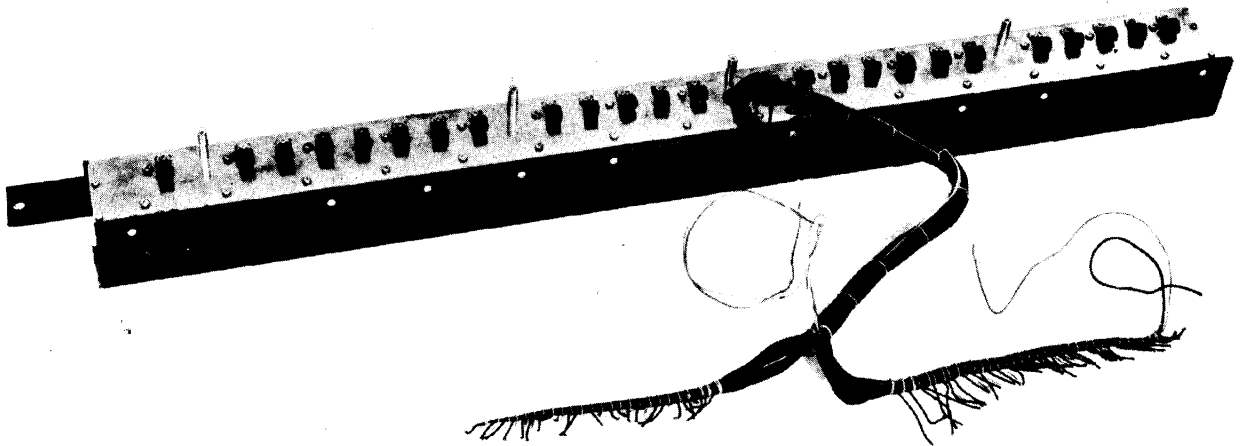

Figure 3-2. Pedal Switch Assembly

and the trouble shooting chart (reference paragraph 3-28). Before starting an elaborate test procedure, make a thorough visual inspection to locate the fault. Check for defective wiring, drops of solder, faulty connections, open resistors and capacitors, jammed tone wheels, etc.

3-3. TUBE TESTING. When the trouble is traced to a specific stage, test tubes in that stage. If tubes are satisfactory, make a point-to-point voltage check in accordance with paragraph 3-4.

3-4. VOLTAGE AND RESISTANCE MEASUREMENTS. Make voltage and resistance measurements on the individual components of the

3-5. RESISTORS. Resistors used in Hammond Organs are marked with the standard EIA (Electronic Industries Association) color code, as shown in Table II. In this code, the body color or first color ring (starting from the outside edge) indicates the first digit of the resistor value. The second ring denotes the second digit, and the third ring represents the number of zeros after the second digit. Thus a resistor marked with brown, green, and yellow rings (in that order) would have a value of 150,000 ohms. Gold and silver rings represent percentage tolerance, gold indicating 5 percent tolerance and silver indicating 10 percent tolerance. Replace

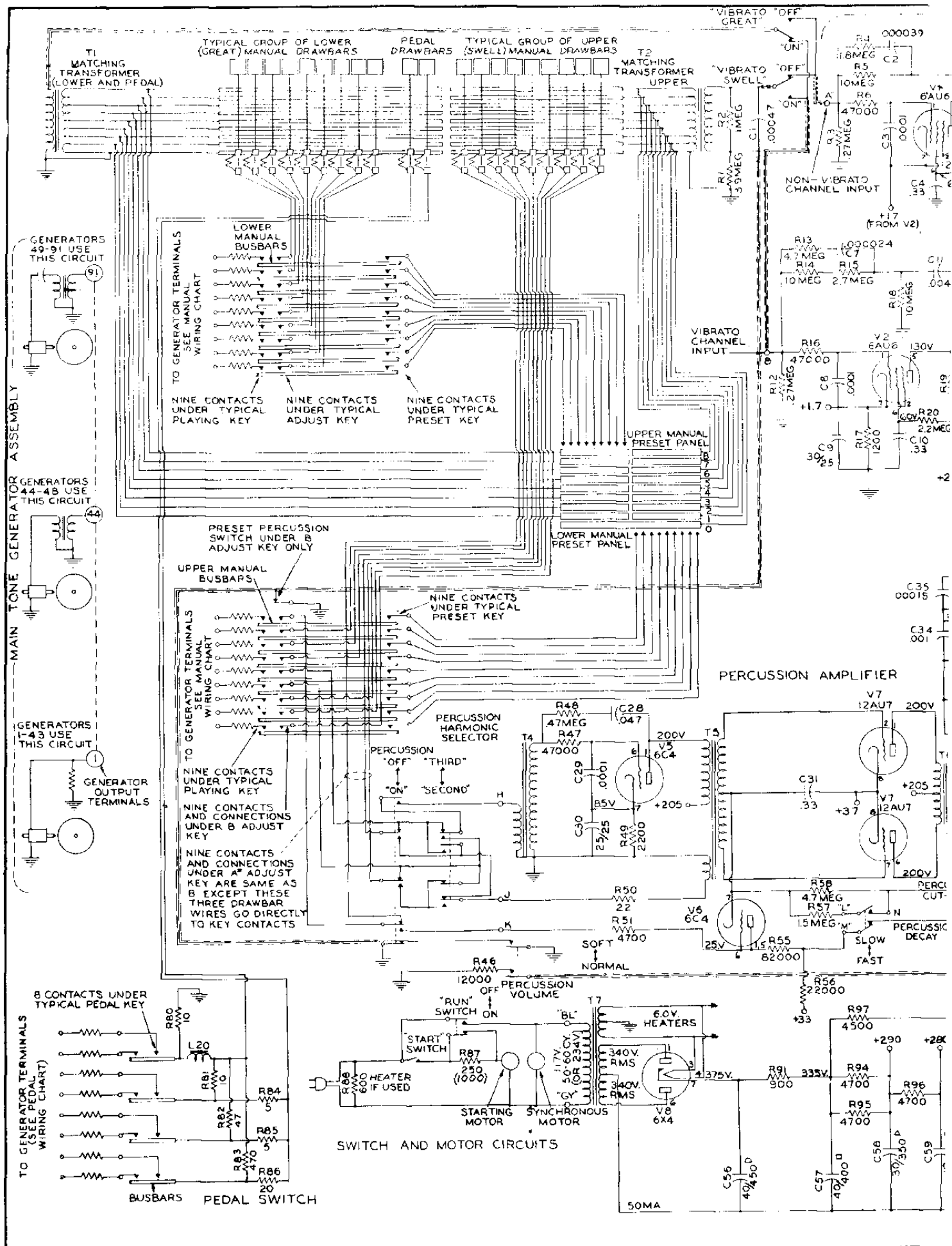

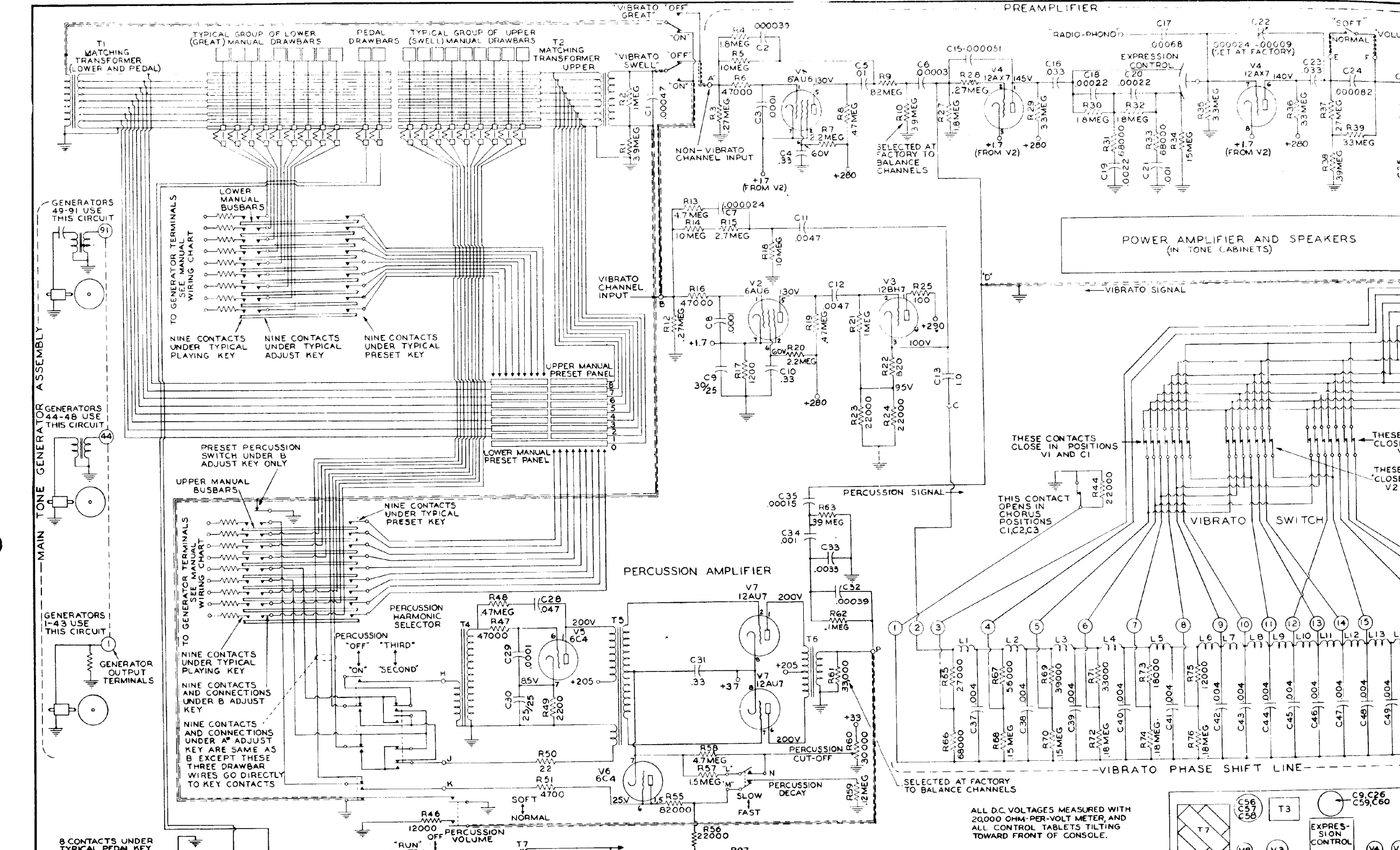

MAIN TONE GENERATOR ASSEMBLY

GENERATORS 49-91 USE THIS CIRCUIT (91)

GENERATORS 44-48 USE THIS CIRCUIT (44)

GENERATORS 1-43 USE THIS CIRCUIT (1)

GENERATOR OUTPUT TERMINALS

8 CONTACTS UNDER TYPICAL PEDAL KEY

T1 MATCHING TRANSFORMER (LOWER AND PEDAL)

TYPICAL GROUP OF LOWER (GREAT) MANUAL DRAWBARS

PEDAL DRAWBARS

TYPICAL GROUP OF UPPER (SWELL) MANUAL DRAWBARS

T2 MATCHING TRANSFORMER UPPER

LOWER MANUAL BUSBARS

UPPER MANUAL PRESET PANEL

LOWER MANUAL PRESET PANEL

NINE CONTACTS UNDER TYPICAL PLAYING KEY

NINE CONTACTS UNDER TYPICAL ADJUST KEY

NINE CONTACTS UNDER TYPICAL PRESET KEY

NINE CONTACTS UNDER TYPICAL PRESET KEY

PRESET PERCUSSION SWITCH UNDER B ADJUST KEY ONLY

UPPER MANUAL BUSBARS

PERCUSSION HARMONIC SELECTOR

PERCUSSION "OFF" "THIRD" "ON" "SECOND"

NINE CONTACTS UNDER TYPICAL PLAYING KEY

NINE CONTACTS AND CONNECTIONS UNDER B ADJUST KEY

NINE CONTACTS AND CONNECTIONS UNDER A ADJUST KEY ARE SAME AS B EXCEPT THESE THREE DRAWBAR WIRES GO DIRECTLY TO KEY CONTACTS

PERCUSSION VOLUME

SOFT NORMAL

"RUN" SWITCH OFF

T7

"VIBRATO" "OFF" "ON"

"VIBRATO SWELL" "OFF" "ON"

"VIBRATO GREAT" "OFF" "ON"

NON-VIBRATO CHANNEL INPUT

VIBRATO CHANNEL INPUT

SELECTED AT FACTORY TO BALANCE CHANNELS

PREAMPLIFIER

V1 6AU5 130V

V2 6AU6 130V

V3 12BH7 100V

V4 12AX7 145V

V4 12AX7 140V

RADIO-PHONO

EXPRESSION CONTROL

"SOFT" "NORMAL" "VOLUME"

PERCUSSION AMPLIFIER

V7 12AU7 200V

V7 12AU7 200V

PERCUSSION CUT-OFF

PERCUSSION DECAY

SLOW FAST

POWER AMPLIFIER AND SPEAKERS (IN TONE CABINETS)

VIBRATO SIGNAL

PERCUSSION SIGNAL

VIBRATO SWITCH

THESE CONTACTS CLOSE IN POSITIONS VI AND CI

THESE CLOSE V2

THESE CLOSE V2 A

PERCUSSION PHASE SHIFT LINE

R65 27000

R66 68000

R67 15004

R68 15 MEG

R69 56000

R70 39000

R71 33000

R72 18 MEG

R73 18000

R74 18 MEG

R75 12000

R76 18 MEG

R77 33000

R78 18 MEG

R79 30000

R80 30000

R81 33000

R82 15 MEG

R83 39 MEG

R84 22000

R85 22000

R86 22000

R87 22000

R88 22000

R89 22000

R90 22000

R91 22000

R92 22000

R93 22000

R94 22000

R95 22000

R96 22000

R97 22000

R98 22000

R99 22000

R100 22000

R101 22000

R102 22000

R103 22000

R104 22000

R105 22000

R106 22000

R107 22000

R108 22000

R109 22000

R110 22000

R111 22000

R112 22000

R113 22000

R114 22000

R115 22000

R116 22000

R117 22000

R118 22000

R119 22000

R120 22000

R121 22000

R122 22000

R123 22000

R124 22000

R125 22000

R126 22000

R127 22000

R128 22000

R129 22000

R130 22000

R131 22000

R132 22000

R133 22000

R134 22000

R135 22000

R136 22000

R137 22000

R138 22000

R139 22000

R140 22000

R141 22000

R142 22000

R143 22000

R144 22000

R145 22000

R146 22000

R147 22000

R148 22000

R149 22000

R150 22000

R151 22000

R152 22000

R153 22000

R154 22000

R155 22000

R156 22000

R157 22000

R158 22000

R159 22000

R160 22000

R161 22000

R162 22000

R163 22000

R164 22000

R165 22000

R166 22000

R167 22000

R168 22000

R169 22000

R170 22000

R171 22000

R172 22000

R173 22000

R174 22000

R175 22000

R176 22000

R177 22000

R178 22000

R179 22000

R180 22000

R181 22000

R182 22000

R183 22000

R184 22000

R185 22000

R186 22000

R187 22000

R188 22000

R189 22000

R190 22000

R191 22000

R192 22000

R193 22000

R194 22000

R195 22000

R196 22000

R197 22000

R198 22000

R199 22000

R200 22000

C1-C38

C9,C26,C59,C60

T3

T7

EXPRESSION CONTROL

ALL D.C. VOLTAGES MEASURED WITH 20,000 OHM-PER-VOLT METER, AND ALL CONTROL TABLETS TILTING TOWARD FRONT OF CONSOLE.



6 CONDUCTOR CONSOLE-TO-CABINET CABLE

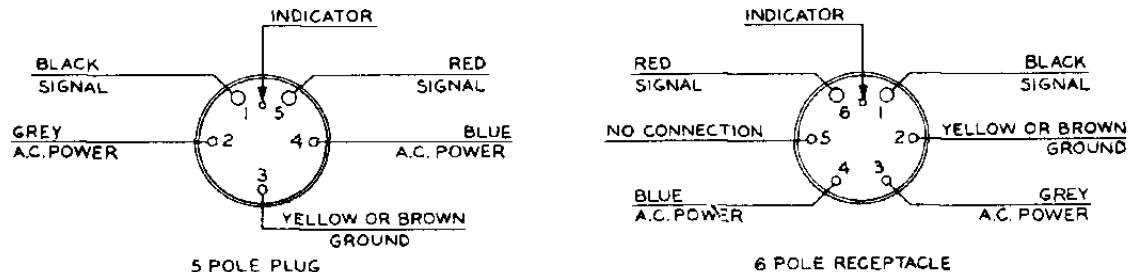

5 CONDUCTOR CABINET-TO-CABINET, CONSOLE-TO-CABINET, OR AMPLIFIER-TO-AMPLIFIER COUPLING CABLE



3 CONDUCTOR CABINET-TO-CABINET OR AMPLIFIER-TO-AMPLIFIER SIGNAL CABLE

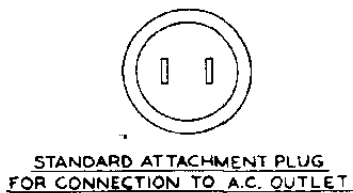

STANDARD ATTACHMENT PLUG FOR CONNECTION TO A.C. OUTLET

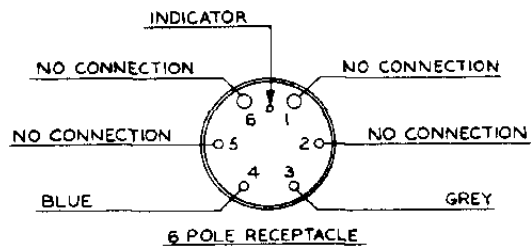

2 CONDUCTOR AMPLIFIER POWER CORD

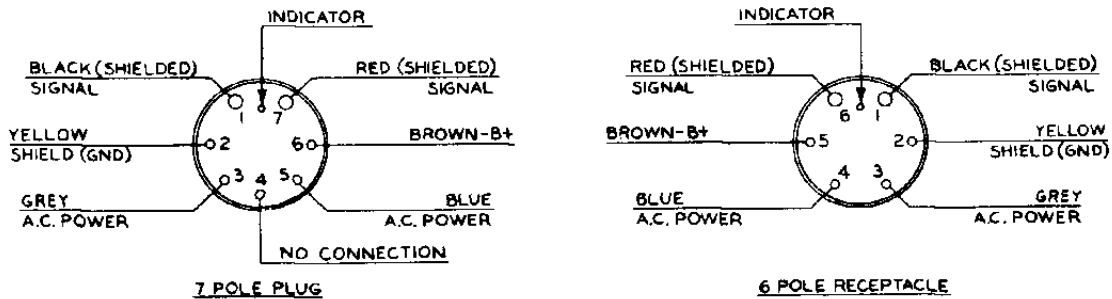

6 CONDUCTOR REVERBERATION-PREAMPLIFIER-TO-POWER-AMPLIFIER COUPLING CABLE

ALL VIEWS SHOW BACK OR CABLE SIDE OF CONNECTOR

Figure 2-2. Cable Connectors

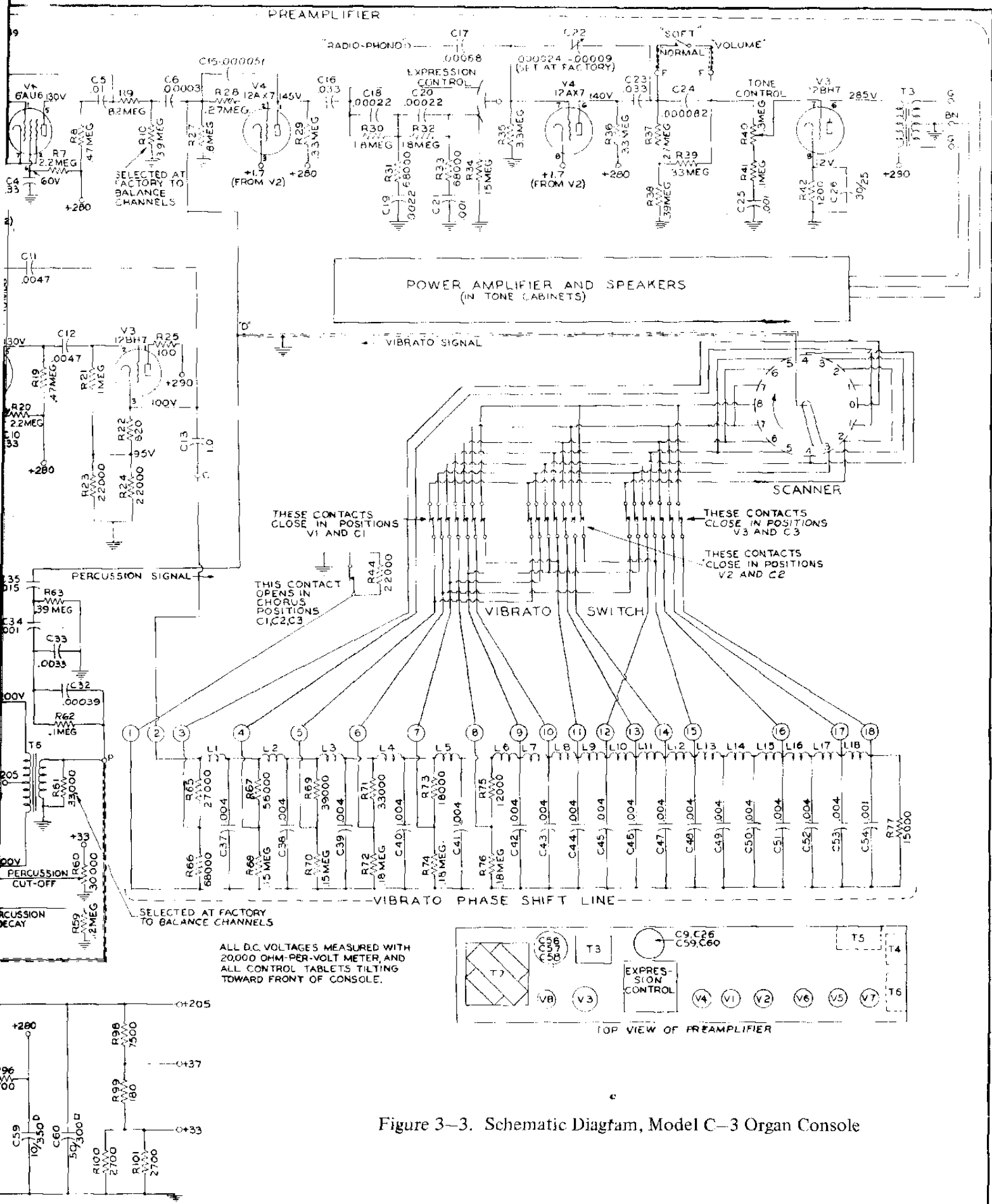

Figure 3-3. Schematic Diagram, Model C-3 Organ Console

resistors differing by as much as 30 percent from their rated values.

TABLE II - RESISTOR COLOR CODE

0-Black	4-Yellow	
1-Brown	5-Green	
2-Red	6-Blue	8-Gray
3-Orange	7-Violet	9-White

3-6. COIL MEASUREMENTS. For the DC (direct current) resistance value of chokes and audio transformers, refer to the appropriate circuit diagram. An open winding in the choke or transformer will be indicated by no ohmmeter indication. Check the power and filament transformers by comparing their measured voltage with the voltages given in the circuit diagram. All voltage values are given for a 117-volt (or 234-volt) AC input. If the input voltage varies, a corresponding change will be noted.

3-7. SECTIONALIZING TROUBLE

3-8. AMPLIFICATION SYSTEM TROUBLES.

3-9. Such troubles as loss of volume, poor quality, excessive hum, noisy operation, or no signal are usually traceable to the amplification system. For example, if distortion is noted in the loud speakers, connect a headset across terminals marked "G" "G" on the console preamplifier. (See figure 1-7.) If the quality is good on the headset, the cause of the distortion will be found in the amplification system following the console preamplifier. Should distortion occur at the preamplifier terminals, replace all tubes. Should distortion in the console preamplifier continue, test each preamplifier stage individually with the headset. When the defective stage is located, test each capacitor and resistor for deterioration.

CAUTION

Insert an 0.1 mfd, 400-volt DC capacitor in series with the headset to prevent DC voltage from damaging it.

3-10. HUM.

3-11. Hum in the loud speakers may indicate trouble in the reverberation spring system assembly. (Reference paragraph 3-28.) If a sustained hum or howl is heard, starting only when a low note is played at high volume, check for the following:

- Microphonic tubes in the amplifier. Replace all tubes if necessary.
- Improper grounding of all plug connections to and from the amplifier.

c. Defective bypass capacitors in the reverberation portion of the amplifier.

d. Locked spring system.

e. Improper mounting of the reverberation unit.

f. Presence of undesirable magnetic fields, such as motors, generators, supply transformers, and other equipment generating heavy magnetic field patterns.

3-12. LOCATING AND CORRECTING DEFECTIVE INDIVIDUAL TONES.

3-13. Silent or weak individual tones are usually caused by defects in the circuit ahead of the amplification system. Such defects can be traced to the tone generator and filter circuits, key circuits and board connections, and signal wiring between the manual chassis, generators, and pedal switch. Trouble occurring over the full range of tones and present at the input to the console preamplifier can usually be traced to a defect in the mixing transformer or associated circuitry.

3-14. LOCATING DEFECTIVE TONES.

3-15. Depress preset key A# on the upper manual. (See figure 1-1.)

3-16. Pull out the first (No. 1) brown drawbar only in the first set of drawbars in the left-hand group.

3-17. Start with the first key, C, (frequency No. 13) of the upper manual and strike each higher note on this manual in succession. The last note at the right end of the keyboard is C (frequency No. 61). Note the frequency numbers of all weak or dead notes. Table III indicates all key numbers and notes and the corresponding frequency numbers for each drawbar.

3-18. Return the first brown drawbar to its original position and then pull out the last white drawbar only, in the same drawbar set. (Reference paragraph 3-16.) Start at the second C note (frequency No. 61), and strike each higher note on the upper manual in succession until the second F# note from the top of the keyboard is reached. This F# note corresponds to frequency #91, the highest frequency produced by the generator. Note the frequency number of all weak or dead notes.

3-19. Repeat the procedures of paragraphs 3-15 to 3-18 inclusive, on the lower manual. Use the No. 1 brown and No. 9 white drawbars in the first set of drawbars in the right-hand drawbar group.

TABLE III - FREQUENCY NUMBERS ASSIGNED TO KEYS AND PEDALS

*Frequency number assigned to keyboard harmonics										
Key No.	Note	Drawbar 1 subfund.	Drawbar 2 Sub-3d	Drawbar 3 fund.	Drawbar 4 2d harm.	Drawbar 5 3d harm.	Drawbar 6 4th harm.	Drawbar 7 5th harm.	Drawbar 8 6th harm.	Drawbar 9 8th harm.
1	C	13	20	13	25	32	37	41	44	49
2	C#	14	21	14	26	33	38	42	45	50
3	D	15	22	15	27	34	39	43	46	51
4	D#	16	23	16	28	35	40	44	47	52
5	E	17	24	17	29	36	41	45	48	53
6	F	18	25	18	30	37	42	46	49	54
7	F#	19	26	19	31	38	43	47	50	55
8	G	20	27	20	32	39	44	48	51	56
9	G#	21	28	21	33	40	45	49	52	57
10	A	22	29	22	34	41	46	50	53	58
11	A#	23	30	23	35	42	47	51	54	59
12	B	24	31	24	36	43	48	52	55	60
13	C	13	32	25	37	44	49	53	56	61
14	C#	14	33	26	38	45	50	54	57	62
15	D	15	34	27	39	46	51	55	58	63
16	D#	16	35	28	40	47	52	56	59	64
17	E	17	36	29	41	48	53	57	60	65
18	F	18	37	30	42	49	54	58	61	66
19	F#	19	38	31	43	50	55	59	62	67
20	G	20	39	32	44	51	56	60	63	68
21	G#	21	40	33	45	52	57	61	64	69
22	A	22	41	34	46	53	58	62	65	70
23	A#	23	42	35	47	54	59	63	66	71
24	B	24	43	36	48	55	60	64	67	72
25	C	25	44	37	49	56	61	65	68	73
26	C#	26	45	38	50	57	62	66	69	74
27	D	27	46	39	51	58	63	67	70	75
28	D#	28	47	40	52	59	64	68	71	76
29	E	29	48	41	53	60	65	69	72	77
30	F	30	49	42	54	61	66	70	73	78
31	F#	31	50	43	55	62	67	71	74	79
32	G	32	51	44	56	63	68	72	75	80
33	G#	33	52	45	57	64	69	73	76	81
34	A	34	53	46	58	65	70	74	77	82
35	A#	35	54	47	59	66	71	75	78	83
36	B	36	55	48	60	67	72	76	79	84

TABLE III - FREQUENCY NUMBERS ASSIGNED TO KEYS AND PEDALS
(Continued)

*Frequency number assigned to Keyboard harmonics										
Key No.	Note	Drawbar 1 subfund.	Drawbar 2 sub-3d	Drawbar 3 fund.	Drawbar 4 2d harm.	Drawbar 5 3d harm.	Drawbar 6 4th harm.	Drawbar 7 5th harm.	Drawbar 8 6th harm.	Drawbar 9 8th harm.
37	C	37	56	49	61	68	73	77	80	85
38	C#	38	57	50	62	69	74	78	81	86
39	D	39	58	51	63	70	75	79	82	87
40	D#	40	59	52	64	71	76	80	83	88
41	E	41	60	53	65	72	77	81	84	89
42	F	42	61	54	66	73	78	82	85	90
43	F#	43	62	55	67	74	79	83	86	91
44	G	44	63	56	68	75	80	84	87	80
45	G#	45	64	57	69	76	81	85	88	81
46	A	46	65	58	70	77	82	86	89	82
47	A#	47	66	59	71	78	83	87	90	83
48	B	48	67	60	72	79	84	88	91	84
49	C	49	68	61	73	80	85	89	80	85
50	C#	50	69	62	74	81	86	90	81	86
51	D	51	70	63	75	82	87	91	82	87
52	D#	52	71	64	76	83	88	80	83	88
53	E	53	72	65	77	84	89	81	84	89
54	F	54	73	66	78	85	90	82	85	90
55	F#	55	74	67	79	86	91	83	86	91
56	G	56	75	68	80	87	80	84	87	80
57	G#	57	76	69	81	88	81	85	88	81
58	A	58	77	70	82	89	82	86	89	82
59	A#	59	78	71	83	90	83	87	90	83
60	B	60	79	72	84	91	84	88	91	84
61	C	61	80	73	85	80	85	89	80	85

TABLE III - FREQUENCY NUMBERS ASSIGNED TO KEYS AND PEDALS
(Continued)

Frequency numbers assigned to Pedal harmonics									
Pedal No.	Note	Fund.	3d harm.	2d harm.	4th harm.	6th harm.	8th harm.	10th harm.	12th harm.
1	C	1	13	13	25	32	37	41	44
2	C#	2	14	14	26	33	38	42	45
3	D	3	15	15	27	34	39	43	46
4	D#	4	16	16	28	35	40	44	47
5	E	5	17	17	29	36	41	45	48
6	F	6	18	18	30	37	42	46	49
7	F#	7	19	19	31	38	43	47	50
8	G	8	-	20	32	39	44	48	51
9	G#	9	-	21	33	40	45	49	52
10	A	10	-	22	34	41	46	50	53
11	A#	11	-	23	35	42	47	51	54
12	B	12	-	24	36	43	48	52	55
13	C	13	32	25	37	44	49	53	56
14	C#	14	33	26	38	45	50	54	57
15	D	15	34	27	39	46	51	55	58
16	D#	16	35	28	40	47	52	56	59
17	E	17	36	29	41	48	53	57	60
18	F	18	37	30	42	49	54	58	61
19	F#	19	38	31	43	50	55	59	62
20	G	20	39	32	44	51	56	60	63
21	G#	21	40	33	45	52	57	61	64
22	A	22	41	34	46	53	58	62	65
23	A#	23	42	35	47	54	59	63	66
24	B	24	43	36	48	55	60	64	67
25	C	25	44	37	49	56	61	65	68

*These frequency numbers are assigned arbitrarily for convenience and are not related to the actual frequencies.

3-20. If all notes are uniform in intensity or change evenly from note to note, the tone generators are operating normally. However, if notes are weak or absent, proceed as directed in paragraph 3-21.

3-21. CORRECTION.

3-22. A single dead or weak note which occurs on one manual but not on the other, may be caused by a fault in the key contacts. To correct this fault, adjust the bus bar shifters associated with the pedal switch and both manuals as directed in paragraphs 4-9 to 4-13 inclusive.

3-23. A single weak or dead note occurring at the same point on both manuals may be caused by a defective generator, a broken wire, or a poorly soldered joint on the terminal strip. Test

the generator for output by fastening a short length of wire to the 6th bus bar, from the bottom, on the preset panel; then touch the other end of the wire to each lug on the generator terminal strip. If all notes sound, the cable wire or soldered joint is at fault and must be repaired. If no generator output exists, either the filter circuit or the magnet pickup coil may be defective, or the tone wheel is not rotating. 3-24. Figure 3-4 illustrates the position of each filter reactor and capacitor on the generator cover. Fasten a short piece of wire to the 6th bus bar, from the bottom, on the preset panel, and test each terminal of the filter. (Reference paragraph 3-23.) If the filter is at fault, replace the defective component as described in paragraphs 5-86 and 5-87.

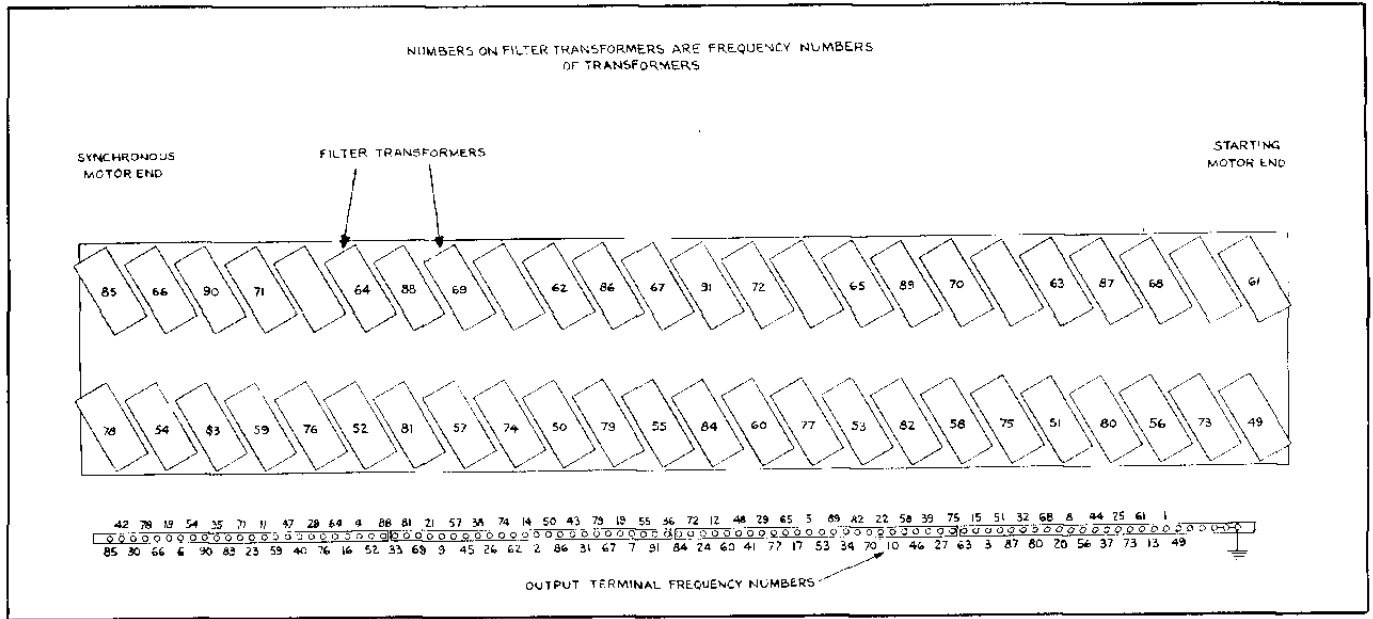

Figure 3-4. Location of Filters on Tone Generator

3-25. If there is no signal across the magnet pickup coil terminals, even with the coil disconnected, either the coil is defective or the associated tone wheel is not turning. Check the pickup coil by unsoldering its lead and, with a short piece of wire, connect the lead to the preset panel. (Reference paragraph 5-6.)

3-26. When there are two dead notes on each manual, determine which frequencies are at fault, as described in paragraphs 3-14 to 3-20 inclusive. Figure 3-5 illustrates the exact location of the magnet associated with each frequency; the dotted lines connecting the frequency num-

bers indicate that they are generated by two tone wheels on the same shaft and in the same compartment. (It should be noted that, with few exceptions, tone wheels on the same shaft differ in frequency numbers by 48.) On frequency numbers 37, 38, 39, 40, and 41, only a single active tone wheel is on each shaft. If the 2 magnets associated with the dead notes are together, 1 tone wheel is probably jammed against the magnet tip. To correct this condition, proceed as follows:

- a. Loosen the set screw on the magnet to be adjusted, then move the magnet back slightly.

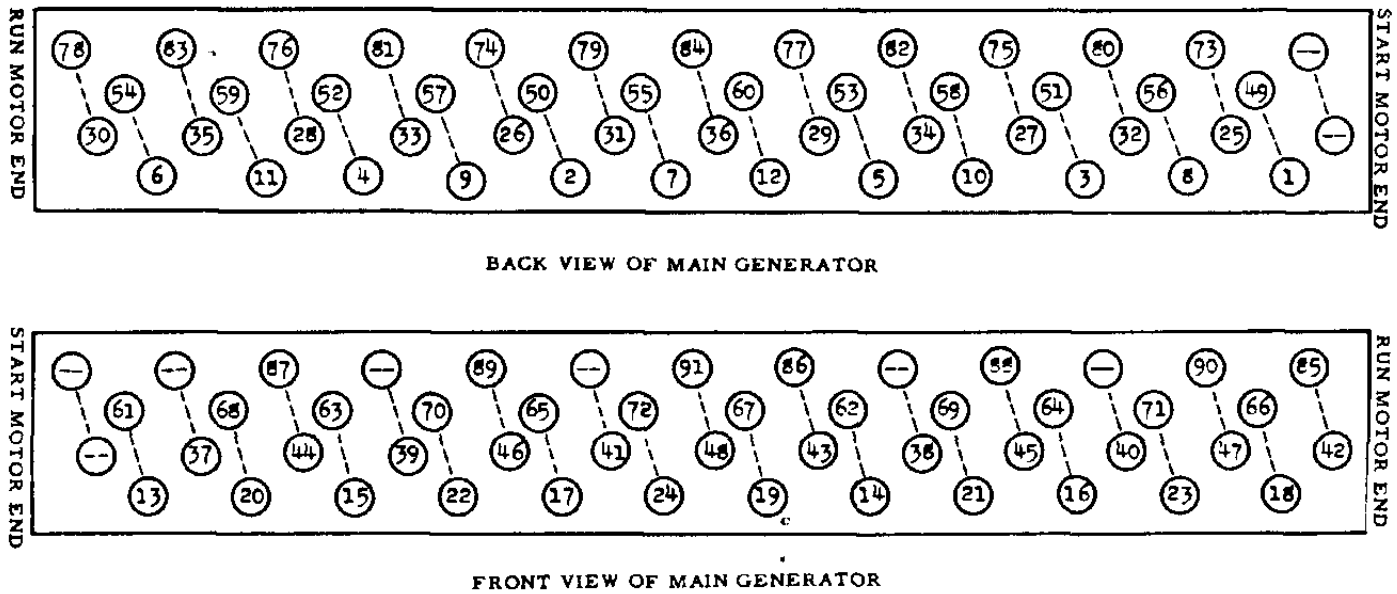

(NUMBERS SHOWN ARE FREQUENCY NUMBERS.)

Figure 3-5. Generator Magnet Locations

Do not twist it.

b. Strike the proper playing key. The note should now sound.

c. To make the final adjustment, strike and hold down the playing key for the note being adjusted. Then tighten the magnet slightly in position and tap it gently until it moves close to the tone wheel to bring the intensity up to the intensity of the adjacent notes. Tighten the set screw so that the magnet is held firmly in position.

d. Do not remove main tone generator assembly from the console unless absolutely necessary. Should this be necessary, proceed as directed in paragraphs 5-63 to 5-71 inclusive.

3-27. TROUBLESHOOTING CHART.

3-28. The following troubleshooting chart contains general information to aid in the location of trouble. When the trouble stage is sectionalized, refer to Section V for detailed aid in identifying the trouble with a particular part.

SYMPTOM	PROBABLE CAUSE OR REMEDIAL ACTION
1. No Signal	<p>Check the source of supply; a 117-volt, 60-cycle (or 234-volt, 50-cycle), AC power source is required. Check the power and connecting cables for secure mounting, good contact, and broken pins. Check the power supply voltage in the tone cabinet. Check all vacuum tubes.</p> <p>Connect output meter across the console pre-amplifier output terminals. If no output is obtained, conduct a point-to-point voltage test on the defective unit.</p> <p>Check the signal input to the power amplifier and compare the reading with the console pre-amplifier output reading on the output meter. These should be identical. If no output reading is obtained, conduct a point-to-point voltage test on the defective unit.</p> <p>Check the power amplifier output. If no output reading is obtained, conduct a point-to-point voltage test.</p>
2. Loss of Volume, All Notes	<p>Low voltage, source of supply.</p> <p>Check the console preamplifier output voltages. Check the power amplifier output voltages. Check all vacuum tubes. (Reference paragraph 3-3.)</p> <p>Low voltage from power supply.</p> <p>Conduct a point-to-point voltage test and check for defective components.</p>
3. Loss of Volume, Single Note	<p>Dust or accumulation of dirt on contact; make adjustment. (Reference paragraphs 4-9 to 4-13 inclusive.)</p> <p>Poorly soldered connection or high resistance contact in console wiring. Trace the signal intensity throughout the circuit by means of high-impedance headset (circuit to ground). As an alternative method, attach one end of an insulated test lead (48 inches long) to 6th bus bar from bottom, on preset panel, and use other lead end to trace the signal intensity throughout the manual wiring.</p>

4. Poor Quality Use low volume, and check the console pre-amplifier output with high impedance headset. Check all vacuum tubes. Make a point-to-point voltage test. (Reference paragraph 3-4.) Check individual components for defects, especially audio bypass capacitors and frequency filters. Be sure that the voice coils are not rubbing against pole pieces.

5. Excessive Hum Check all connecting plugs for loose connections. Check wiring connections in cable plugs. Check for defective filter capacitors in power amplifier. Check all vacuum tubes. Replace if necessary. Remove all inductive electric or electronic equipment in the vicinity of the console cabinet. Check all bypass capacitors, particularly on cathode-to-ground circuits. Check ground connection from generator to two halves of lowest preset panel bar.

6. Rattle or Intermittent Operations Loose connections between cable connectors. Loose cable connections in connector plugs. Damaged speaker cone. Voice coil rubbing on pole piece. Defective vacuum tube. Check lubrication. Check the individual felt pad used on each manual key or bass pedal to absorb the striking sound. Check for intermittent resistors or capacitors by lightly tapping suspected components. Check the suspension of the reverberation spring system assembly. Adjust the bus bar shifters. (Reference paragraphs 4-9 to 4-13 inclusive.)

7. Miscellaneous

a. Howl, or unwanted sustaining of tone Check reverberation unit locking lever. (Reference paragraph 2-6.)

b. Bass pedals release sluggishly Check and increase tension of leaf springs at end of bass pedals.

c. Preset keys fail to release properly Replace leaf bracket and associated leaf spring; replace key if necessary. (Reference paragraphs 5-73 to 5-75 inclusive and see figure 1-6.)

SECTION IV

ALIGNMENT PROCEDURES

4-1. PRESET PANEL TONE SELECTION.

4-2. The preset keys shown in figure 1-2 are used to select the ready-mixed tone colors. Nine color-coded wires from each preset key are fastened to the bus bars of the preset panel by slotted screws. Each group of nine color-coded wires is fed through individual holes below the preset panel. The color coding of each group is identical to the color coding of the nine wires from the drawbars (above the preset panel). The drawbars can be withdrawn to numbered stops. The frequency relationship of the wire color coding is indicated below. Note that the color sequence is the same as the EIA color code for resistors.

Brown	Sub-fundamental
Red	Sub-3rd harmonic
Orange	Fundamental
Yellow	2nd harmonic
Green	3rd harmonic
Blue	4th harmonic
Violet	5th harmonic
Gray	6th harmonic
White	8th harmonic

4-3. The tone color or quality of any note, played on either the upper or lower manual, is determined by the intensity of the harmonics in relation to the fundamental note as selected either by the preset key or drawbars. The numbers of the preset panel and drawbars indicate a progressive increase in intensity, starting from 0 (drawbar fully pushed in) to 8 inclusive. Any

tone color may be identified by a number containing 9 digits, each digit representative of the intensity of the fundamental tone or 1 harmonic as selected on the drawbars or preset panel.

4-4. The Hammond Organ has its preset panel arranged to make available to the organist tonalities similar to those ordinarily found in the small church or chapel pipe organ, as well as tones for religious services and congregational singing, without the use of the adjustable drawbars. Table IV illustrates the approved preset panel arrangement for chapel organs. Remove the rear panel of the console, examine, and check the preset panel to determine that the preset panel corresponds exactly to Table IV. Change the position of any lead by loosening the slotted screw which secures it in place, removing the lead, and then securing it in correct position by means of the slotted screw provided. Refer to figure 4-1.

4-5. ALIGNMENT OF COIL ASSEMBLIES.

4-6. Each magnet and coil for each tone wheel is mounted in the tone generator as a single assembly. (See figure 5-1.) To locate and determine which coil assemblies require alignment, proceed as follows:

- a. Remove the console rear panel.
- b. Connect an output voltmeter (1,000 ohms-per-volt scale) across the two terminals marked "G".

TABLE IV - HAMMOND ORGAN PRESET DATA

UPPER MANUAL				LOWER MANUAL			
Preset Keys	Equivalent Drawbar Setting	Tone Quality	Value	Preset Keys	Equivalent Drawbar Setting	Tone Quality	Value
C		Cancel		C		Cancel	
C#	00 5320 000	Stopped Flute	pp	C#	00 4545 440	Cello	mp
D	00 4432 000	Dulciana	ppp	D	00 4423 220	Flute & String	mp
D#	00 8740 000	French Horn	mf	D#	00 7373 430	Clarinet	mf
E	00 4544 222	Salicional	pp	E	00 4544 220	Diapason, Gamba and Flute	mf
F	00 5403 000	Flute 8' & 4'	p	F	00 6644 322	Great, no reeds	f
F#	00 4675 300	Oboe Horn	mf	F#	00 5642 200	Open Diapason	f
G	00 5644 320	Swell Diapason	mf	G	00 6845 433	Full Great	ff
G#	00 6876 540	Trumpet	f	G#	00 8030 000	Tibia Clausa	f
A	32 7645 222	Full Swell	ff	A	42 7866 244	Full Great with 16'	fff
A#	Adjust harmonic drawbars for 1st Group, Upper Manual			A#	Adjust harmonic drawbars for 1st Group, Lower Manual		
B	Adjust harmonic drawbars for 2nd Group, Upper Manual			B	Adjust harmonic drawbars for 2nd Group, Lower Manual		

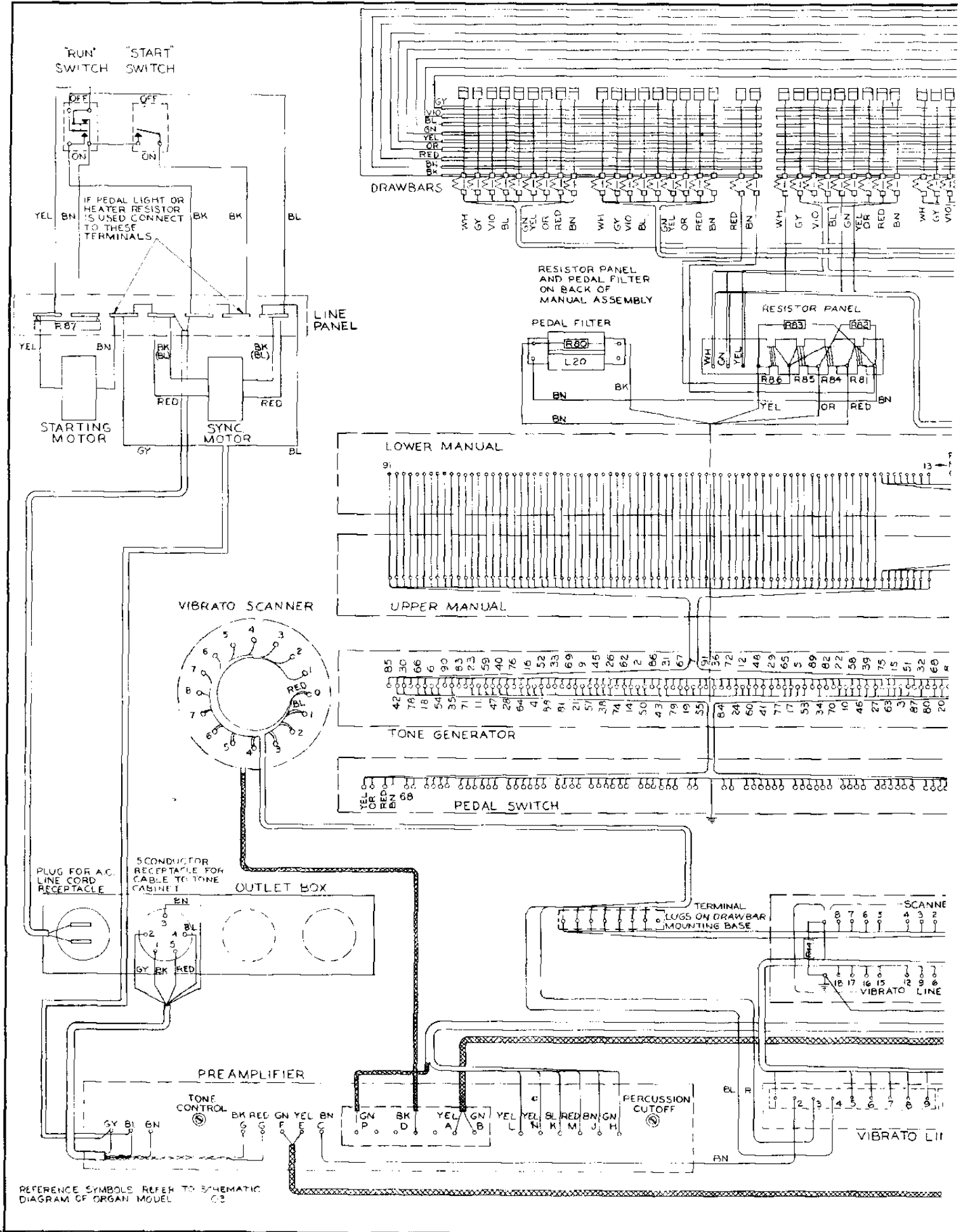

"RUN" SWITCH "START" SWITCH

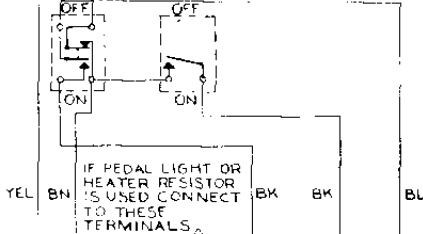

DRAWBARS

RESISTOR PANEL AND PEDAL FILTER ON BACK OF MANUAL ASSEMBLY

RESISTOR PANEL

LINE PANEL

STARTING MOTOR

SYNC MOTOR

LOWER MANUAL

UPPER MANUAL

VIBRATO SCANNER

TONE GENERATOR

PEDAL SWITCH

PLUG FOR A.C. LINE CORD RECEPTACLE

5 CONDUCTOR RECEPTACLE FOR CABLE TO TONE CABINET

OUTLET BOX

TERMINAL LUGS ON DRAWBAR MOUNTING BASE

PREAMPLIFIER

TONE CONTROL

PERCUSSION CUTOFF

VIBRATO LI I

REFERENCE SYMBOLS REFER TO SCHEMATIC DIAGRAM OF ORGAN MODEL C2

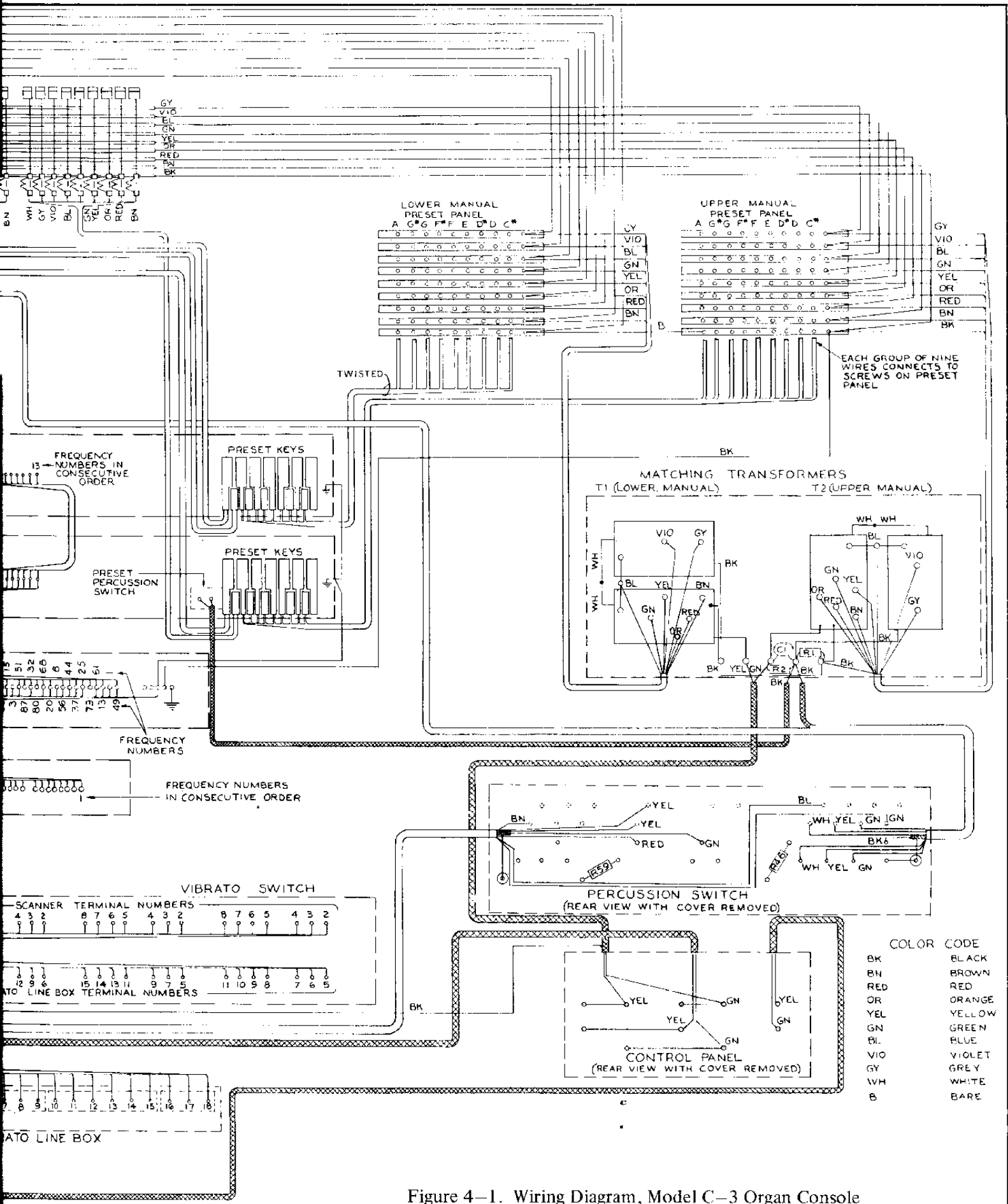

Figure 4-1. Wiring Diagram, Model C-3 Organ Console

4-8. **ADJUSTMENT OF PERCUSSION CUT-OFF CONTROL.** This control, located in the preamplifier (See figure 1-7) should be readjusted whenever control tube V 7 is replaced. Set expression pedal wide open, both volume tablets to "Normal", percussion tablet "ON", and harmonic selector in either position. Play any key in upper half of upper manual, hold it down at least 5 seconds, and then adjust percussion cut-off control exactly to the point where the signal becomes inaudible.

4-9. **ADJUSTMENT OF INTERMITTENT OR NON-OPERATING KEYS.**

4-10. Scratchy, noisy, or silent keys may result from accumulations of dust which lodge in the contacts. To correct this condition, strike the key 15 to 20 times in a rapid staccato manner to dislodge the dust particles and to clear the contacts.

4-11. If this procedure does not dislodge the dust particles, adjust the bus bar shifters. (See figures 1-4, 3-2, 4-2, and 4-3.) Bus bar shifter "A", located behind the mixing transformer, adjusts the bus bars associated with the keys of the upper manual; bus bar shifter "B" adjusts the bus bars associated with the keys of the lower manual; bus bar shifter "C" adjusts the bus bars associated with the pedal keyboard.

4-12. Turn the proper bus bar shifter about two turns in either direction. This operation permits the key contacts to strike a new position on the bus bar and should free all contacts of accumulated dust particles.

4-13. If, in extremely stubborn cases, the procedure above does not dislodge the dust particles, use a board to depress one octave of notes (7 white and 5 black keys) and then adjust the bus bar shifters while holding the keys down.

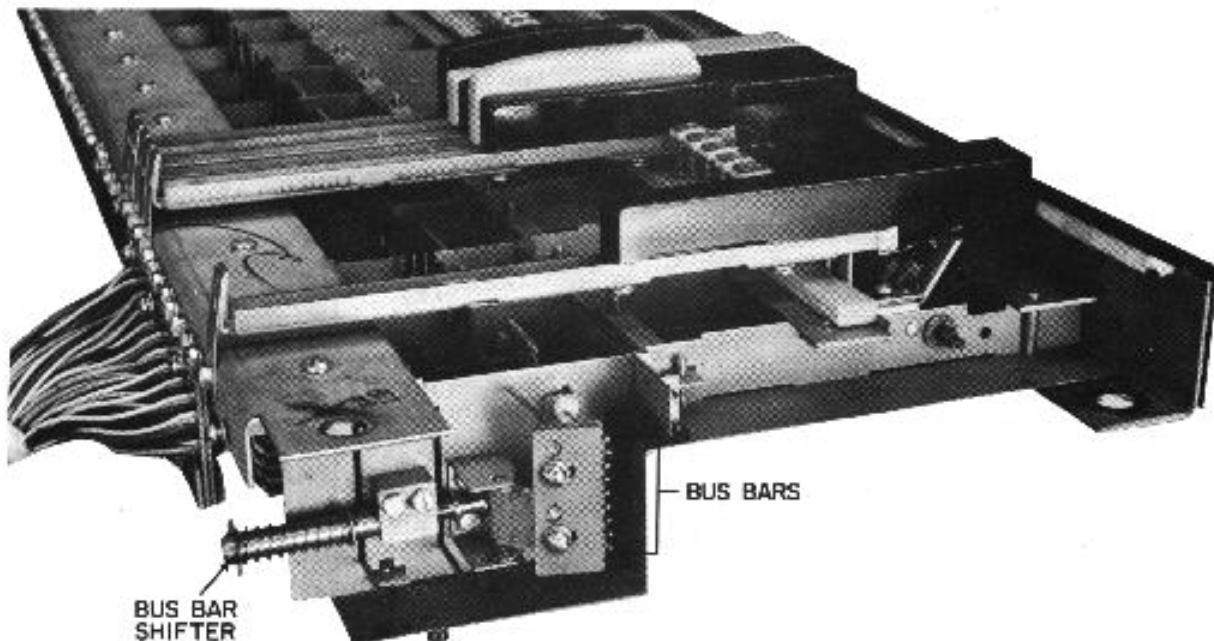

Figure 4-2. Manual Assembly, End View

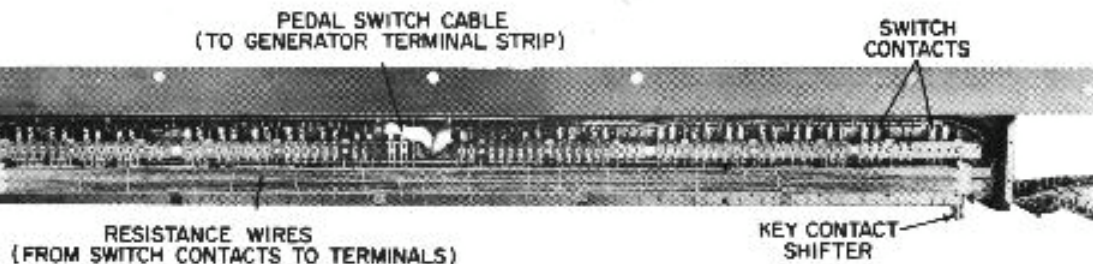

Figure 4-3. Pedal Switch Assembly, Cover Removed

SECTION V

STAGE DATA AND FINAL TESTING

5-1. DETAILED THEORY OF OPERATION.

5-2. MAIN TONE GENERATOR ASSEMBLY.

5-3. The main tone generator assembly consists principally of 48 rotating sub-assemblies (each subassembly consists of a shaft, 2 disks called tone wheels, and a bakelite gear), and a drive shaft which extends the entire length of the generator. This drive shaft is resiliently coupled at one end to a starting motor and at the other end to a synchronous run motor (reference paragraph 5-12), and is divided into several sections connected by semi-flexible couplings. (See figure 1-5.) A series of 24 driving gears, 2 each of 12 sizes, is mounted on this shaft.

5-4. Twenty-four of the 48 rotating subassemblies are mounted on each side of the drive shaft so that each of the driving gears engages 2 bakelite gears associated with opposite rotating sub-assemblies. These bakelite gears rotate freely with the tone wheels on separate shafts and are connected to their respective assemblies by a pair of compression-type springs. The bakelite

gears are provided in 12 different sizes corresponding to the 12 driving gears of different sizes. Consequently, 4 of the tone wheel subassemblies, each containing 2 tone wheels, operate at each of 12 different speeds. Each driving gear, with its associated bakelite gears and 4 tone wheels, is contained in a separate compartment, magnetically shielded from the rest by steel plates which divide the generator into a series of bins. (See figure 5-2.) All four tone wheels in any one compartment run at the same speed.

5-5. Each tone wheel is a steel disk about 2 inches in diameter and contains a predetermined number of high and low points on its outer edge. (See figure 5-1.) Each high point is called a tooth. There are 12 wheels with 2 teeth, 1 wheel to operate at each of the 12 speeds (reference paragraph 5-4); similarly 12 wheels each have 4 teeth, 8 teeth, 16 teeth, 32 teeth, 64 teeth, and 128 teeth; also 7 tone wheels have 192 teeth. A 2-tooth wheel and a 32-tooth wheel form an assembly, giving 2 frequencies, 4 octaves apart. The 4- and 64-tooth wheels

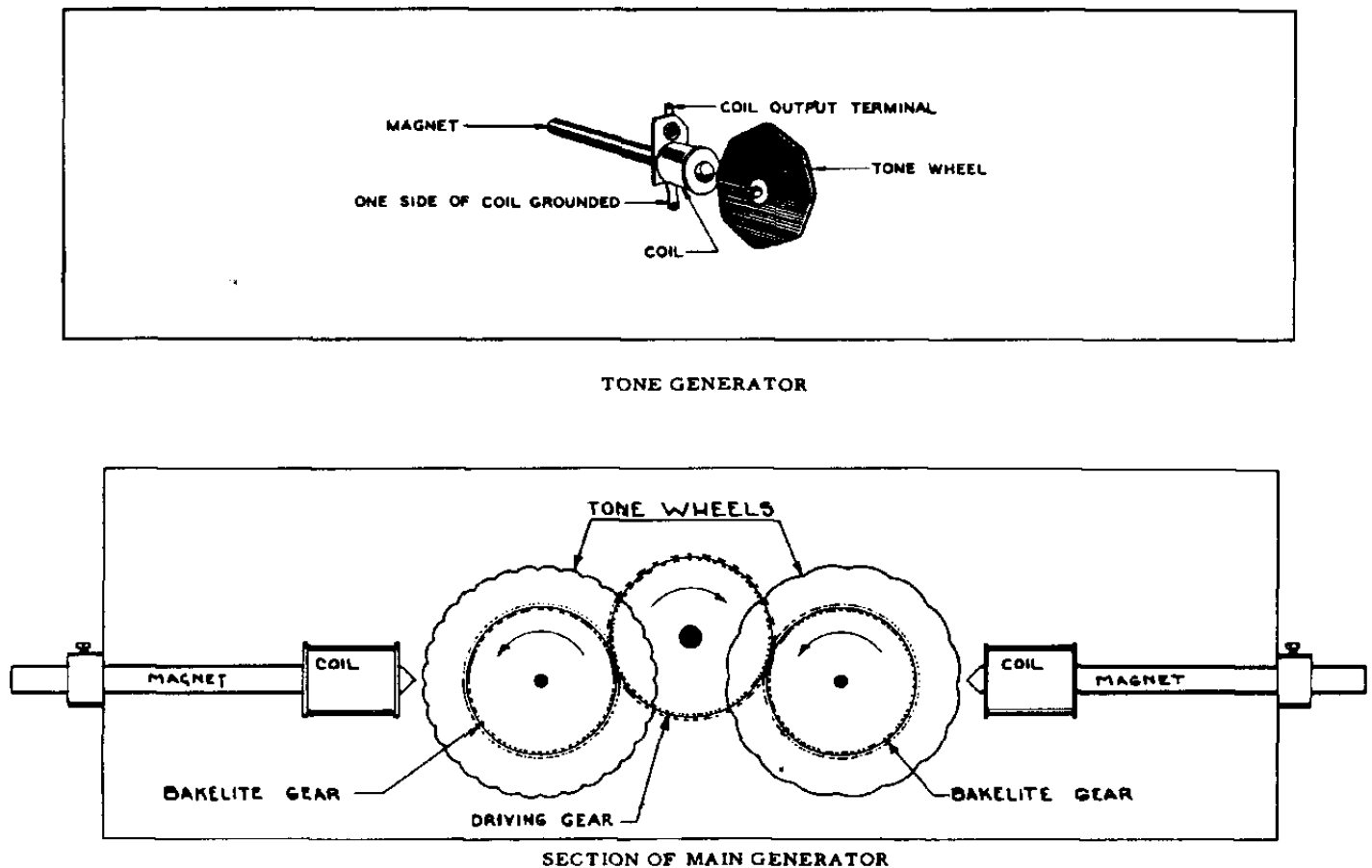
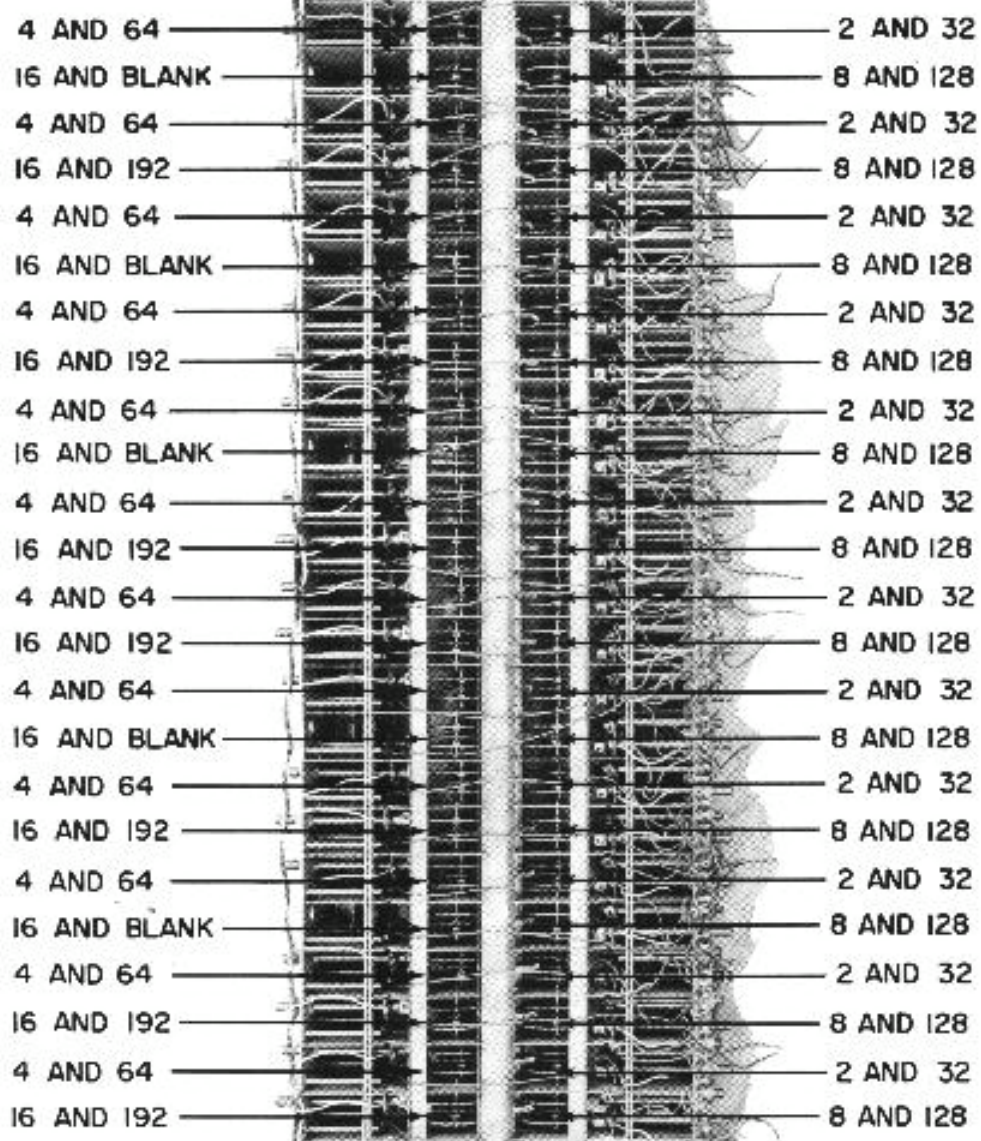

Figure 5-1. Construction of Main Generator



NOTE:
 NUMBERS REFER TO
 THE NUMBER OF
 TEETH ON EACH
 TONE WHEEL.

Figure 5-2. Tone Wheel Tooth Count in Generator

are assembled together, as are the 8- and 128-tooth wheels and the 16- and 192-tooth wheels. Five 16-tooth wheels are mounted with blanks to maintain the balance of the rotating unit. (See figure 5-2.) Only 91 frequencies are required for the organ; for identification purposes these frequencies are numbered 1 to 91 inclusive.

5-6. A magnetized rod, about 4 inches long and 1/4 inch in diameter, is mounted near each tone wheel. (See figures 5-1 and 5-2.) A small coil of wire is wound near one end of the magnet. The tip of the magnet at the coil end is ground to a sharp edge and mounted near the edge of the associated tone wheel. Each time that a tooth of the wheel passes the rod, the magnetic circuit changes and a cycle of voltage is induced in the coil. The voltage is very small and is of known frequency. The frequency is predetermined by the number of teeth and the speed of the rotating tone wheel. Larger coils are used with tone wheels of lower frequencies to provide good low frequency output, but smaller coils are used with tone wheels of higher frequency to prevent excessive losses.

5-7. Copper rings are mounted on certain low frequency coils for the purpose of reducing harmonics. The eddy current loss in such a ring is small for the fundamental frequency of the coil, but is high for its harmonics. As a result, the relative intensities of any harmonics which may be produced by irregularities in the tone wheels are reduced.

5-8. The edge of each tone wheel and the tip of each magnet are coated with lacquer to prevent corrosion, for, should oxidation set in, the change in tooth shape would introduce undesirable frequencies.

5-9. Filters for eliminating spurious harmonics from the generated simple tones are located on the top of the main tone generator, and consist of filter capacitors and reactors. (See figure 3-4.) (These capacitors and reactors are tuned units and are called tone generator filters.)

5-10. The tone generator filters have a single tapped winding. This tap is grounded and one side, which is connected to the associated coil assembly through a capacitor, forms a resonant circuit for the fundamental frequency of that coil. Harmonics are suppressed. The capacitors for frequencies 49 to 54 inclusive are 0.255 mf, and the capacitors for frequencies 55 to 91 inclusive are 0.105 mf. Both capacitors and reactors are used with frequencies numbered 49 to 91 inclusive. On frequencies 44 to 48 inclusive, the capacitors are omitted, but the reactors

used have a greater number of turns. Below frequency 44, neither capacitors nor reactors are used; a length of resistance wire shunts each generator output. This resistance wire is wound on the appropriate magnet coil.

5-11. The tone generator filters are mounted on top of the generator at an angle to minimize reaction between them. Wires connect the filters to the coil assemblies and to the terminal strip on the generator. Ninety-six terminals are provided on this strip; 3 terminals are grounded to the generator frame and serve to ground the manuals and pedals, and 91 terminals carry the various frequencies.

5-12. The start motor is a shaded-pole induction motor. The synchronous run motor (used on 60 cycles) has a 2-pole field and 6-pole armature, and a synchronous speed of 1,200 rpm (revolutions per minute). For 50 cycles, a 4-pole armature is used which has a speed of 1,500 rpm. When the organ is placed into operation, the start switch is first operated to apply power to the start motor. The rotor of the start motor slides endwise and engages a pinion on its shaft which a gear on the generator drive shaft. (See figure 5-3.) When the "RUN" switch is operated, while the start switch is held in "ON" position, power is applied to the synchronous run motor and a 250-ohm resistor (1,000 ohm for 234 volts) is connected in series with the start motor, thus reducing the driving power of the start motor. Because of the braking action and the loss of power of the start motor, the system slows down to, and locks into, synchronous speed; the run motor then begins to carry the load. When the "START" switch is released and springs back into position, the start motor disengages from the drive shaft by action of a spring assembly, and stops.

5-13. The spring couplings of the motor shaft, the flexible couplings between the sections of the drive shaft, and the tone wheel spring couplings are provided to absorb the variations in motor speed. The synchronous motor operates with a series of pulsations, one each half-cycle. If the tone wheels were coupled rigidly to the motor, this irregularity would carry extra frequencies into each tone wheel. The spring suspension system for supporting the main tone generator minimizes the transmission of mechanical vibration between the console cabinet and the main generator.

5-14. VIBRATO EQUIPMENT.

5-15. The vibrato effect is created by a periodic raising and lowering of pitch, and thus is funda-

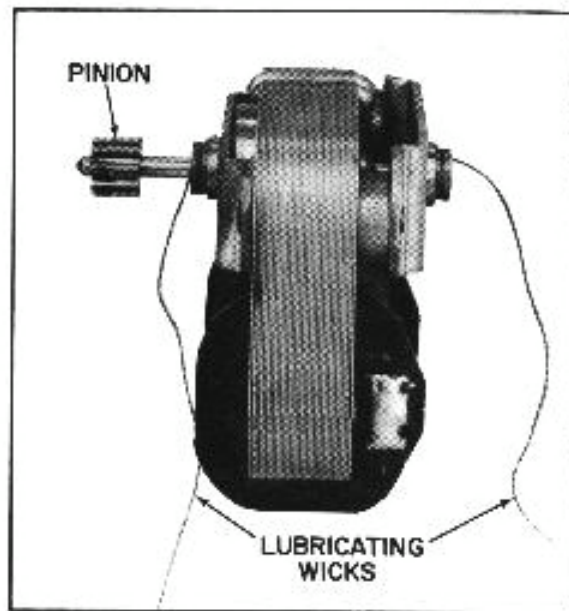

Figure 5-3. Starting Motor

mentally different from a tremolo or loudness variation. It is comparable to the effect produced when a violinist moves his finger back and forth on a string while playing, varying the frequency while maintaining constant volume.

5-16. The Hammond Organ vibrato equipment, as shown in simplified block diagram, figure 5-4, varies the frequency of all tones by continuously shifting their phase. It includes a phase shift network or electrical time delay line, composed of a number of low pass filter

sections, and a capacity type pickup or scanner, which is motor-driven so that it scans back and forth along the line.

5-17. Electrical waves fed into the line are shifted in phase by each line section (the amount per section being proportional to frequency), so that at any tap on the line, the phase is retarded relative to the previous tap.

5-18. The scanning pick-up traveling along the line will thus encounter waves increasingly re-

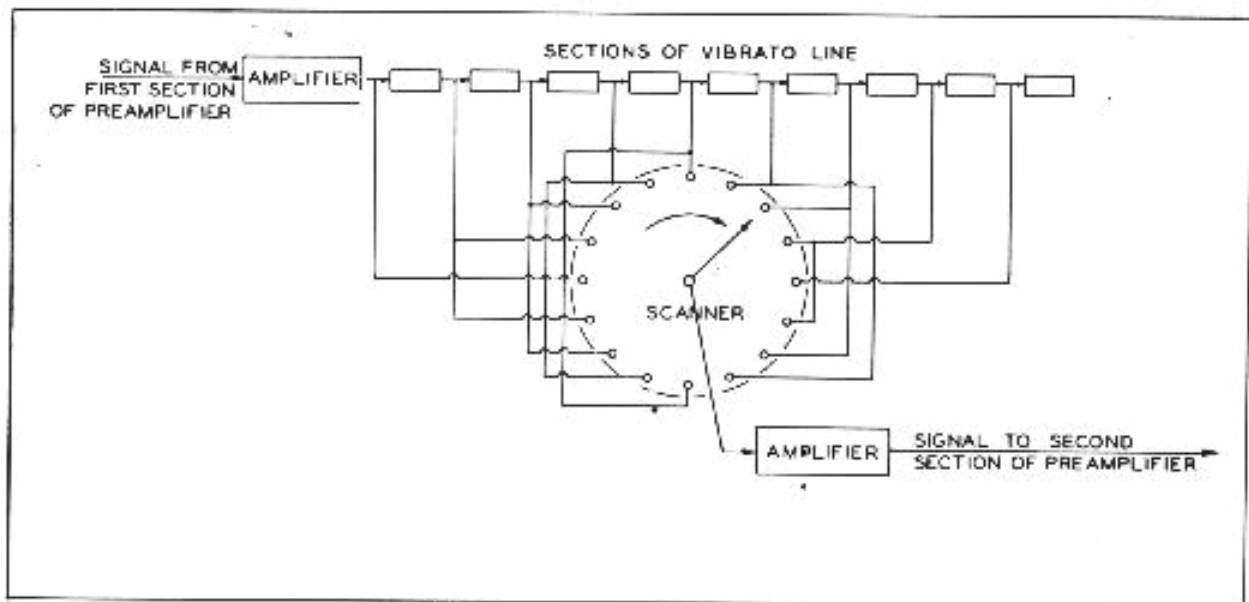

Figure 5-4. Fundamental Diagram of Vibrato System

tarded in phase at each successive tap, and the signal it picks up will continuously change in phase. The rate at which this phase shift occurs will depend on how many line sections are scanned each second.

5-19. Since a cycle is equivalent to 360 electrical degrees, a frequency shift of 1 cycle occurs for each 360 electrical degrees scanned per second. For example, if the scanner passes over the line at such a rate that 3,600 electrical degrees are scanned each second, there will be a frequency change of 10 cycles.

5-20. For the widest vibrato, the whole line is scanned from beginning to end in about 1/14 second, and this rate of change of phase causes about 1-1/2 percent decrease in frequency. Note that the frequency remains constantly 1-1/2 percent low as long as the moving pick-up retards the phase at a constant rate.

5-21. Since the pick-up sweeps from start to end of the line and then back, it increases the frequency by an equal percentage on its return trip, the average output frequency remaining equal to the input frequency. The exact amount of frequency shift depends not only on the amount of phase shift in the line but also on the scanning rate. This rate, however, is constant because the scanner is driven by the synchronous running motor of the organ.

5-22. The degree of vibrato (or amount of frequency shift) may be varied by a switch (not shown in figure 5-4) which causes the whole line to be scanned for No. 3 (wide) vibrato, about half of it for No. 2, and about one-third for No. 1.

5-23. A vibrato chorus effect, similar to the effect of 2 or 3 slightly out-of-tune frequencies mixed together, is obtained when the vibrato output signal is mixed with a portion of signal without vibrato. For vibrato chorus, part of the incoming signal appears across the vibrato line and the rest across a resistor in series with the line. As the vibrato effect is applied to the part of the signal appearing across the line, but not

to the part appearing across the resistor, the combination produces a chorus effect. For normal vibrato, this resistor is short-circuited. In the Model C-3 console the vibrato effect can be applied to either manual separately or to both at once.

5-24. Figure 5-5 shows the vibrato line box. Each of the inductance coils is connected with one or more capacitors to form one filter section.

5-25. Figure 5-7 shows the construction of the vibrato switch.

5-26. The scanner, shown in figure 5-6, is mounted on the main generator synchronous motor and driven at 412 revolutions per minute. It is a multi-pole variable capacitor with 16 sets of stationary plates and a rotor whose plates mesh with the stationary ones. In figure 5-7, Index B, two sets of plates have been removed to show the rotor.

5-27. Signals coming from the line through the vibrato switch appear on the stationary plates and are picked up, one at a time, by the rotor. Connection to the rotor is made by carbon brushes, as shown in figure 5-6, Index A. Two brushes touch the sides of the contact pin and a third presses on the end, in order to eliminate the possibility of contact failure.

5-28. Figure 5-8 shows the vibrato circuit.

5-29. The vibrato switch has no "OFF" position, and 3 vibrato chorus positions (C1, C2, and C3) are included in it as well as the 3 vibrato positions (V1, V2, and V3). The vibrato effect is turned "ON" and "OFF" for each manual separately by means of "VIBRATO SWELL" and "VIBRATO GREAT" tablets on the manual assembly.

5-30. The preamplifier used with this circuit has two separate channels into which signals from the "VIBRATO GREAT" and "VIBRATO SWELL" tablets are fed. (Reference paragraph 5-37.) The "VIBRATO" signal goes through a preliminary amplifier, through the vibrato



Figure 5-5. Vibrato Line Box

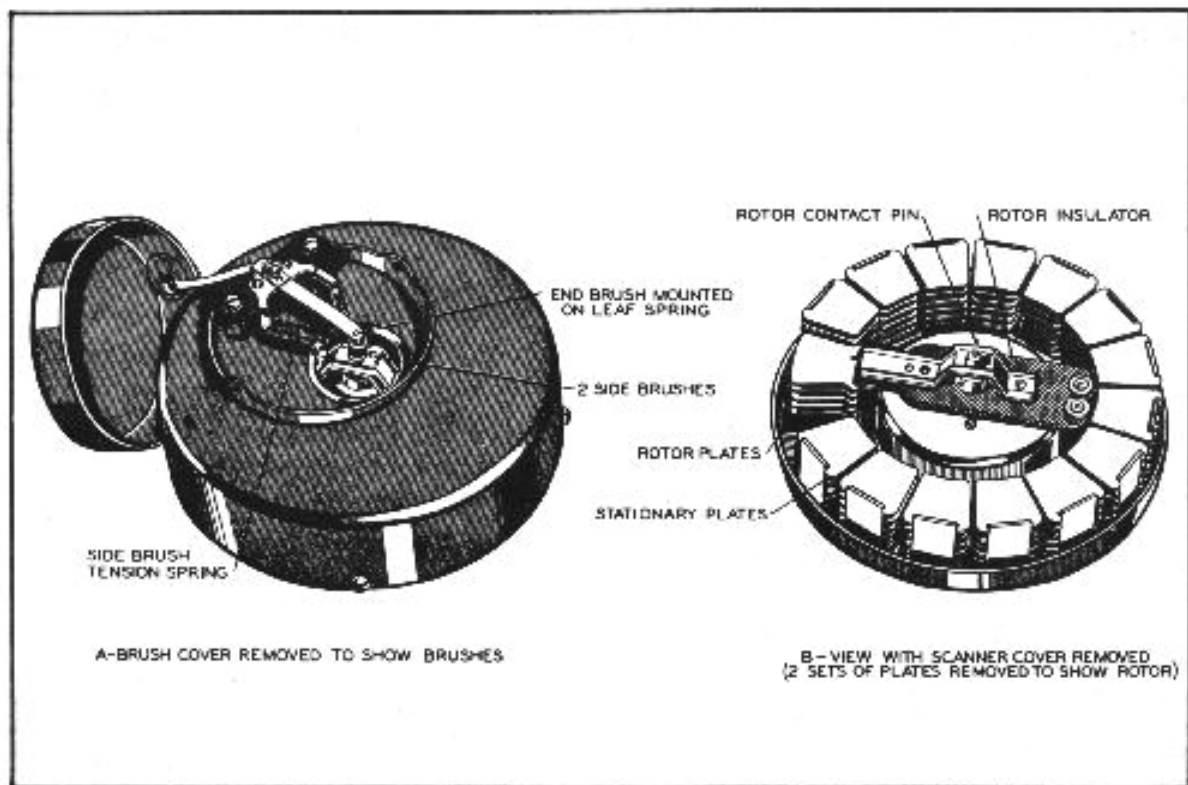

Figure 5-6. Vibrato Scanner

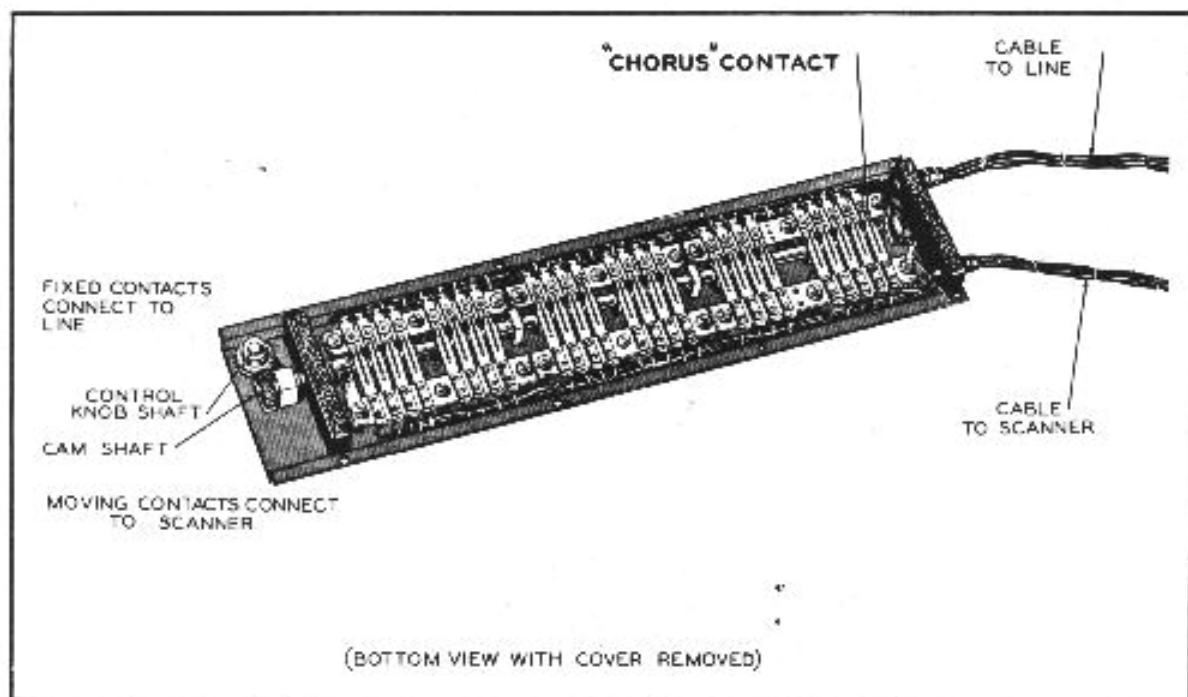

Figure 5-7. Vibrato Switch

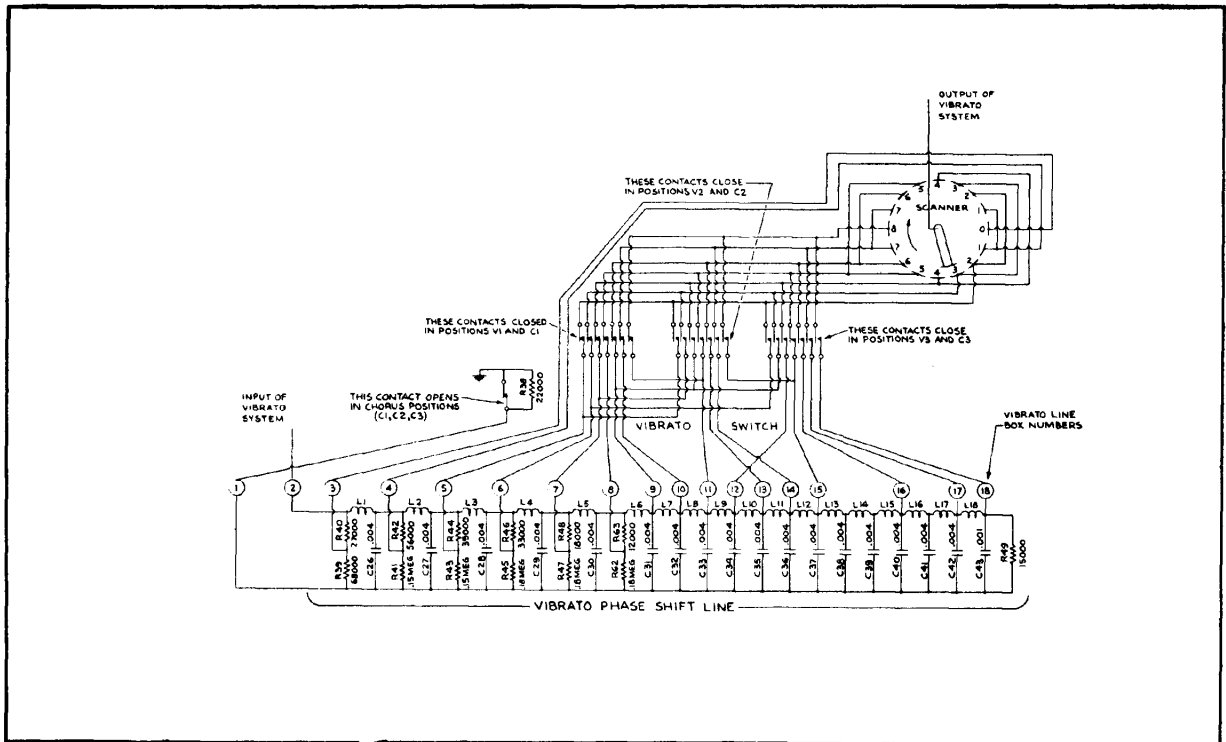

Figure 5-8. Schematic Diagram, Vibrato System

system, and then into additional stages of amplification. The “NO VIBRATO” signal also has a preliminary amplifier, but bypasses the vibrato system and goes directly into the additional amplifier stages.

5-31. MANUAL CHASSIS ASSEMBLY.

5-32. The 9 contact springs on each key are connected by resistance wires to the proper terminals on the terminal strip and carry the harmonics of the particular note with which they are associated. (Reference paragraph 1-20.) The resistance wires avoid overloading of the generators and thus allow each generator to be used independently to feed a number of key circuits. All key contacts are alive at all times. When a playing key is depressed, its 9 frequencies are impressed on the 9 bus bars of the manual. No wires are connected to these bus bars; a preset or adjust key must be depressed to complete the circuit. (See figure 3-3.) Each preset or adjust key is provided with 9 contacts identical to those on the playing keys and is further provided with a locking and tripping mechanism, the purpose of which is to permit only 1 preset or adjust key to be in operation at a time. (See figure 1-6.) The cancel key releases a depressed preset or adjust key; this cancel key has no contacts.

5-33. Flexible wires connect the 9 contacts of each adjust key (A# and B) to the 9 drawbars controlled by the key. The wires are color-coded

for identification. Each drawbar makes contact (according to the stop position to which it is drawn) with any one of 9 bus bars connected to taps on the mixing transformer. (See figure 3-3.) The bus bars correspond to different intensities of sound.

5-34. The 9 preset keys (C# to A) are connected by flexible leads to the preset panel in the back of the console. (See figure 1-4.) The preset panel consists of 2 sets of 9 bus bars which correspond to those in the drawbar assembly and which are connected to the same taps on the mixing transformers.

5-35. The mixing transformers are mounted on the manual chassis assembly as shown in figure 1-4. Shielded leads carry the signals from the secondaries of these transformers to the pre-amplifier.

5-36. PEDAL SWITCH ASSEMBLY. The pedal switch assembly is similar in operation to the manual chassis assembly (reference paragraphs 5-31 to 5-35 inclusive); the pedal switch assembly, however, contains only 4 bus bars instead of 9. A flat spring at the end of each pedal of the detachable pedal clavier depresses a small plunger, as shown in figure 3-2, on the pedal switch assembly and actuates a double set of contact springs, thus making eight contacts available for each note. The pedal contact springs are connected by decoupling resistance

wires to terminals. A cable connects these terminals through a wiring tube to the proper terminals on the main tone generator strip. The pedal switch bus bars are connected, by means of four colored wires, through a filter reactor and resistor network to the pedal drawbars. (See figure 5-9.) The reactor and resistors filter out undesirable higher harmonics and serve to balance the pedal tones.

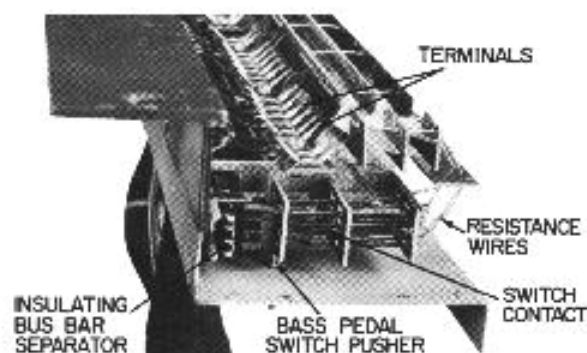

Figure 5-9. Pedal Switch Contacts

5-37. VOLUME CONTROL AND PRE-AMPLIFIER ASSEMBLY.

5-38. Typical Circuit Before Pre-amplifier.

5-39. Each voltage of predetermined frequency produced by the tone generator is connected to one or more key contacts. When the associated playing key is depressed, this voltage is impressed upon the bus bar and is carried through the preset key switch to the preset panel. The voltage is then fed to one of the several taps of the mixing transformer which is associated with the manual being played. From the high impedance secondary of the mixing transformer, this voltage (combined with others which may be fed through simultaneously) passes to one of the preamplifier input circuits. (Vibrato "ON" or "OFF" circuit).

5-40. Power to operate the preamplifier and power amplifier is supplied through the run switch circuit as shown in figure 3-3.

5-41. Preamplifier Circuit. Input.

5-42. The signal from each mixing transformer is sent to the Vibrato "ON-OFF" tablet associated with its particular manual, and is then carried to the "VIBRATO" or "NO VIBRATO" preamplifier input, depending on the position of the tablet.

5-43. The input circuits are similar, with one

extra stage of amplification in the "VIBRATO" channel to compensate for the loss that occurs through the phase shift network and associated scanner. The input tube V4 receives the signals from "VIBRATO" and "NO VIBRATO" circuits and further amplifies them. The signal then is impressed on the "LOUD" stator of the volume control, and on the "SOFT" stator through a compensating network.

5-44. Volume or Swell Control.

5-45. The volume control is activated by the swell pedal connected by an appropriate linkage. (See figure 1-4.) The volume control assembly consists of two sets of stator plates, similar to those used in the scanner assembly. (See figure 5-6.) A rotor assembly of similar size is moved by the swell pedal and is capable of meshing with either stator or a portion of each. The degree of mesh determines the strength of the entire signal.

5-46. The signal is further amplified by the second section of V4 and sent to driver tube V3 which in turn drives the 12BH7 output tube.

5-47. PERCUSSION SYSTEM. (See figure 3-3.)

5-48. The "Touch Response" percussion feature is controlled by four tilting tablets (figure 1-1). It is available only on the upper manual and only when the "B" adjust key is depressed. Percussion tones are produced by borrowing the second or third harmonic (depending on position of the "Percussion Harmonic Selector" tablet) from the corresponding drawbar of the upper manual "B" adjust key group, amplifying it, returning part of it to the same drawbar, and conducting the balance through push-pull control tubes which, when keyed, cause the signal to fade away at a pre-determined rate.

5-49. With the percussion tablet on, "B" adjust key pressed, and an upper manual playing key pressed, the second or third harmonic signal goes to percussion input terminal II on the pre-amplifier chassis and is amplified by T4 and T5. The percussion input transformer T5 not only provides push-pull signal for the control tube V7 but also has a third winding which feeds signal back to the 2nd or 3rd harmonic drawbar through equivalent key circuit resistor R50 and terminal "J".

5-50. When a key is depressed, the note first sounds loudly, after passing through the control tube V7, transformer T6, a high pass filter, and terminal D to the grid of V4. Immediately, capacitor C31 in the control tube grid circuit begins to discharge, causing the signal to fade away.

5-51. This circuit works as follows: Terminal K (Approximately -25 volts) is connected to the 8th harmonic "B" adjust key drawbar wire, which is connected through the adjust key contact to the manual bus bar. Pressing any upper manual key connects this bus bar to a tone generator terminal and virtually grounds terminal K through the tone generator filters. This virtually grounds the plate of V6, stops conduction, isolates the cathode of V6, and thus isolates the grid circuit of control tube V7. The grid then drifts from about -25 volts to about -15 volts, at a rate determined by the time required for C31 to discharge through R57 and R58. At the completion of this sequence, the percussion signal is blocked so that it is no longer audible.

5-52. No further percussion signal can be heard until all keys of the upper manual are released so that the control tube V7 grids can again drop to -25 volts (the rate of this drop is fixed by the time required to charge C31 to -15 volts through R55 and R56). Thus the percussion effect is heard only when keys are played in a detached manner; that is, when all keys are released before pressing the next one.

5-53. REVERBERATION UNIT. (See figure 1-10.) This device simulates musically desirable echoes in a large room. An electrical signal from the amplifier is applied to the driver coil in the reverberation unit, which converts the electrical signal into a twisting movement of 3 coil springs. This motion is transmitted along each spring to a pickup unit, where part of it is converted back to electrical energy. The remaining portion is reflected back to the driver and again back to the pickup after a time interval determined by the spring length. This reflection process continues until the signal level is reduced to about one millionth of its signal value so that it is no longer audible. The springs are different in length and thus there are 3 separate sets of echoes, each repeated a number of times. Electronic amplification circuitry associated with the reverberation unit is contained in the power amplifier, described below.

5-54. POWER AMPLIFIER. (See figure 5-10.)

5-55. This is a 3-channel amplifier with 2 treble channels (one for non-reverberated and one for reverberated signal) and a bass channel, with a cross-over point of 200 cycles. Each channel has two 6BQ5 output tubes with self-bias. Each treble channel drives a 12" speaker, and the bass channel drives two 15" speakers in parallel.

5-56. The power supply unit is a separate chassis housing the power transformer, rectifier tubes, filter, and input connections for power and signal. A 6-pin plug engages the console cable, and a 5-pin receptacle is provided for plugging in additional tone cabinets. The console cable consists of 5 conductors; 2 for AC power, 2 for push-pull signal, and ground.

5-57. The push-pull signal from the console (G1 and G2) drives treble input tube V1. Resistance-capacitance filters ahead of V1 filter out signal frequencies below 200 cycles. V1 drives output tubes V2 and V3 of the treble direct channel. It also drives double triode tube V9 which, in turn, drives the reverberation unit.

5-58. The output of the reverberation unit passes through transistor TR-1, and part of the signal goes to the treble reverberation switch. This adjusts the amount of reverberated signal going into V10, which drives output tubes V11 and V12 of the treble reverberation channel. The switch, in its "off" position, picks up signal from input terminal G1, in order to make use of the channel for non-reverberated signal when the treble reverberation is off.

5-59. Both treble channel output transformers have tertiary windings which supply inverse feedback signal to the cathodes of the output tubes.

5-60. A portion of the output of transistor TR-1 goes to double triode tube V4, which is connected as a phase splitter to drive the push-pull bass channel. The output of V4 goes to the bass reverberation switch, which is also connected to the input terminals G1 and G2. The bass channel receives a large amount of reverberated signal along with some direct signal in the "HI" position, only non-reverberated signal in the "OFF" position, and varying mixtures in the intermediate positions.

5-61. A filter network following the bass reverberation switch filters out signal frequencies above 200 cycles. Following it is a "room size" switch which can be used to provide better balance by reducing the bass volume when used in a small room. The signal then feeds push-pull tubes V5 and V6, which drive the bass output tubes V7 and V8.

5-62. REPLACEMENT OF COMPONENTS

5-63. TONE GENERATOR ASSEMBLY

5-64. Remove the four hexagonal-head bolts and their associated springs and T-washers which

secure the generator assembly to the console.

5-65. Remove the four screws from the left and right-hand side panels of the music rack. Tilt the bottom of the music rack by lifting the side panels, and remove the rack by pulling outward.

5-66. Remove the 4 chassis bolts (underneath the console) and the 2 machine screws (under the front lower manual rail) that hold the entire manual chassis in place.

5-67. Disconnect the 79 manual leads, 68 pedal leads, 4 ground wires, and the pedal filter leads. The pedal filter is located on the rear surface of the upper manual assembly.

5-68. Pull out all drawbars to position 8, and then tilt the manual chassis from the front as far as the top of the console will permit. Place suitable wedges or blocks on both sides of the manual chassis to hold it in this position. The manual chassis must be tilted to provide adequate clearance for the bolts in the corners of the main generator assembly.

5-69. Unhook the four suspension springs on which the generator assembly rides.

5-70. Lift up the generator assembly and remove it at the rear of the console.

5-71. Install a replacement generator assembly by reversing the procedure given above for removing it.

5-72. MIXING TRANSFORMER ASSEMBLY. The Assembly of two mixing transformers is provided complete with all leads to the preset panels, and can be removed as follows:

- a. Remove the rear panel.
- b. Remove the two screws which secure the transformer cover in place.
- c. Label and disconnect all leads from the mixing transformers where they connect to the preset panels.
- d. Unsolder green and yellow shielded wires at mixing transformers.
- e. Remove the two wood screws which secure the mixing transformer assembly to the manual chassis block.
- f. Secure the replacement mixing transformer assembly in place by reversing the procedures given above.

5-73. PLAYING KEY.

5-74. Replacement of playing key on upper manual will be accomplished as follows:

- a. Remove the four screws from the left and right-hand side panels of music rack. Tilt the bottom of the rack by lifting the side panels and then remove the rack by pulling outward.

- b. Remove the 2 wood screws and the 2 oval-head bolts from the ends of the drawbar base.

- c. Lift and block up the entire drawbar base.

- d. To remove a black key, loosen its key mounting screw, unhook key from screw, and lift out key.

- e. To remove a white key, loosen its key mounting screw and those of adjacent black keys. Unhook these keys from screws, push them back, and lift out white key.

- f. Insert a replacement key and install by reversing the directions given above for removal.

- g. Adjust the tension of the replacement playing key by comparison with the adjoining key.

5-75. Replacement of playing key on lower manual will be accomplished as follows:

- a. Remove the four screws from the left- and right-hand side panels of the music rack. Tilt the bottom of the rack by lifting the side panels and then remove the rack by pulling outward.

- b. Remove the two oval-head bolts from the ends of the stop base.

- c. Pull out all drawbars to position 8.

- d. Tilt the upper manual as far back as the top of the console will allow, and then wedge or block it in this position.

- e. Complete the replacement of the playing key on the lower manual by following the same procedure given above for upper manual keys.

5-76. PEDAL SWITCH ASSEMBLY.

5-77. Replacement of pedal switch assembly will be accomplished as follows:

- a. Remove the pedal clavier by lifting it up in front and then pulling straight back. (See figures 1-3 and 3-1.)

CAUTION

Be careful to prevent damage to the delicately constructed pusher levers (switch pushers) at the end of each pedal.

- b. Unsolder the pedal cable wires from terminals on the generator.

- c. Disconnect the brown and black leads from the filter located on the rear surface of the upper manual assembly.

- d. Disconnect the orange, red, and yellow pedal signal leads from the resistor strip on the rear surface of the upper manual assembly.

- e. Use small wooden blocks to raise and support the entire console a few inches off the floor to provide the necessary clearance for the removal of the pedal switch assembly.

- f. Loosen and remove the screws which hold the wiring tube (through which the pedal wiring

cable passes to the tone generator) to the console shelf, the 3 oval-head and 1 hexagonal-head screws which hold the pedal switch in place, and the screw which holds the swell pedal rod in place.

g. Lift the cover board and remove the screws which hold the pedal switch assembly to the back rail of the console.

h. Loosen the large bolt at each end of the pedal switch assembly, then remove the nuts attached to these bolts. Drop the assembly carefully and remove it.

i. Install a replacement pedal switch assembly in place by reversing the procedures above.

5-78. MANUAL CHASSIS.

5-79. Replacement of manual chassis will be accomplished as follows:

a. Remove the rear panel of the console. (Reference paragraph 1-10.)

b. Remove the four screws on the left- and right-hand side panels of the music rack.

c. Lift the side panels to tilt the bottom of the rack, and then remove the rack by pulling outward.

d. Remove the 4 chassis bolts (under the console) and the 2 machine screws (under the front lower rail) that secure the entire manual chassis in place.

e. Disconnect all preamplifier leads.

f. Loosen set screw in expression control lever arm and detach arm from preamplifier.

g. Remove preamplifier from shelf after taking out mounting screws.

h. Unsolder (do not cut) the 79 manual leads, 2 ground leads, 3 pedal signal leads (red, orange, and yellow), and the pedal filter leads (brown and black).

i. At the power terminal panel, unsolder the five wires leading to the manual chassis start and run-motor switches. Determine these leads by tracing the leads from the switches.

j. Detach pilot lamp bracket by removing two wood screws.

k. Unsolder eight scanner wires from terminals on back of drawbar base.

l. Unsolder brown wire from vibrato line.

m. Tie the disconnected cables to the chassis to prevent damage to the other console components when the manual chassis is removed.

n. Remove the manual chassis through the rear of the console. Slide the chassis out carefully. Because of frame construction, the chassis will drop suddenly before it is entirely out of the console. Two men are required to remove the manual chassis from the console.

o. Install a replacement chassis by reversing

the procedure above. (See Figure 2-2 for cable connections).

5-80. SWITCHES FOR START AND RUN MOTORS.

5-81. The switches for the start and run motors are both mounted on the same metal plate; the following replacement instructions are equally applicable to each:

a. Remove the black bakelite switch handle by unscrewing it in a counter-clockwise direction.

b. Remove the round knurled nut which holds the switch to the metal plate.

c. Remove the four oval-head screws which hold the switch plate to the music rack.

d. Remove the rear panel of the console.

e. Unsolder the leads (from the defective switch) at the power terminal panel on the generator. (See figure 2-1.) One lead (black) is wired to the start switch. Four leads, 1 yellow, 1 black, 1 blue, and 1 brown, are wired to the run switch. (See figure 4-1.) Unscrew or unsolder jumper wire between switches.

f. Remove the tape which secures the wires together. Unbraid the wires connected to the defective switch up to the manual chassis so that the switch can be removed.

g. Pull out the switch. Note the position of the switch with respect to the color of the wires so that the replacement switch will be installed in the correct position.

h. Install the new switch in the proper position. Braid and tape the wires carefully so that they will not interfere with the operation of the generator run motor.

i. Solder the leads of the replacement switch to the power terminal panel.

j. Operate the switch to determine that it has been installed properly.

k. Replace the rear panel.

5-82. START MOTOR (See figure 5-3).

5-83. Replacement of the start motor will be accomplished as follows:

a. To make the start motor accessible, follow the procedure for removing the main tone generator. (Reference paragraph 5-63.)

b. Remove start motor capillary threads from oiling trough.

c. Disconnect the leads to the start motor at the power terminal panel on the generator.

d. Using a socket wrench, remove the two start motor mounting screws.

e. Secure a replacement start motor in position by reversing the procedures above.

5-84. RUN MOTOR AND VIBRATO SCANNER ASSEMBLY. (See figure 2-1.)

5-85. Replacement of run motor and vibrato scanner assembly will be accomplished as follows:

- a. Remove the rear panel.
- b. At the power terminal panel on the generator, unsolder the red and black wires which lead to the run motor that is to be replaced. (See figure 4-1.)
- c. Unsolder 7 scanner wires from terminals on back of stop base and 2 scanner wires from line box.
- d. Remove shielded lead attached to "SCAN" at preamplifier.
- e. The running motor is secured by four machine screws to the generator frame. Remove the nuts and lockwashers, and then disengage the flywheel coupling springs.

f. Remove the entire motor and scanner assembly by means of a gentle pull.

g. Secure a replacement motor and vibrato scanner assembly in place by reversing the procedures above.

5-86. TONE GENERATOR FILTERS.

5-87. Filters used for frequencies numbered 49 to 91 inclusive, as referenced in paragraphs 5-9 to 5-11 inclusive, are resonant reactor-capacitor units, and will be replaced as follows:

- a. Unsolder all leads.
- b. Remove the two screws holding the filter.
- c. Remove the component.
- d. Replace the component by reversing the procedures above.

SECTION VI

RECOMMENDED SPARE PARTS LIST

6-1. GENERAL. — This section contains a list of recommended spare parts, arranged in Hammond part number sequence. The location of each listed part in the organ is illustrated in Figures 6-1 through 6-14. Illustrations are grouped together at the end of the section.

6-2. REPAIR PARTS LIST.

FIGURE & INDEX NO.	HAMMOND PART NO.	DESCRIPTION	VENDOR OR MIL PART NO.	VENDOR OR SPEC
6-4-48	001-021070	Transistor	2N3391A	General Electric Company
6-5-12	002-005201	Tube, Electron	5U4GB	JEDEC
6-7-25	002-006201	Tube, Electron	6X4	JEDEC
6-7-24	002-006300	Tube, Electron	6C4	JEDEC
6-5-5	002-006500	Tube, Electron	6AU6	JEDEC
6-5-6	002-006700	Tube, Electron	6BQ5	JEDEC
6-5-7	002-012300	Tube, Electron	12AU7A	JEDEC
6-5-8	002-012301	Tube, Electron	JAN12AX7	JEDEC
6-5-9	002-012302	Tube, Electron	JAN12BH7A	JEDEC
6-1-40	003-022020	Transformer Assembly		
6-6-59	003-024112	Transformer, Audio Frequency		
6-6-58	003-024891	Transformer Assembly (115 V 60 Hz only)		
6-6-60	003-024895	Transformer, Audio Frequency		
6-5-10	003-025327	Transformer, Audio Frequency		
6-11-1	003-025417	Transformer, Power, Distribution (115 V 60 Hz only)		
6-3-43	003-034226	Transformer, Audio Frequency		
6-3-29	003-034227	Transformer, Audio Frequency		
6-3-39	003-034228	Transformer, Audio Frequency		
6-3-25	003-034229	Transformer, Audio Frequency		
6-3-35	003-034230	Transformer, Audio Frequency		
6-3-21	003-034231	Transformer, Audio Frequency		
6-3-31	003-034232	Transformer, Audio Frequency		
6-3-41	003-034233	Transformer, Audio Frequency		
6-3-27	003-034234	Transformer, Audio Frequency		
6-3-37	003-034235	Transformer, Audio Frequency		
6-3-23	003-034236	Transformer, Audio Frequency		
6-3-33	003-034237	Transformer, Audio Frequency		
6-3-19	003-034238	Transformer, Audio Frequency		
6-3-8	003-034239	Transformer, Audio Frequency		
6-3-16	003-034240	Transformer, Audio Frequency		
6-3-5	003-034241	Transformer, Audio Frequency		
6-3-13	003-034242	Transformer, Audio Frequency		
6-3-2	003-034243	Transformer, Audio Frequency		
6-3-10	003-034244	Transformer, Audio Frequency		

REPAIR PARTS LIST (CONT)

FIGURE & INDEX NO.	HAMMOND PART NO.	DESCRIPTION	VENDOR OR MIL PART NO.	VENDOR OR SPEC
6-3-18	003-034245	Transformer, Audio Frequency		
6-3-7	003-034246	Transformer, Audio Frequency		
6-3-15	003-034247	Transformer, Audio Frequency		
6-3-4	003-034248	Transformer, Audio Frequency		
6-3-12	003-034249	Transformer, Audio Frequency		
6-3-42	003-034250	Transformer, Audio Frequency		
6-3-28	003-034251	Transformer, Audio Frequency		
6-3-38	003-034252	Transformer, Audio Frequency		
6-3-24	003-034253	Transformer, Audio Frequency		
6-3-34	003-034254	Transformer, Audio Frequency		
6-3-20	003-034255	Transformer, Audio Frequency		
6-3-30	003-034256	Transformer, Audio Frequency		
6-3-40	003-034257	Transformer, Audio Frequency		
6-3-26	003-034258	Transformer, Audio Frequency		
6-3-36	003-034259	Transformer, Audio Frequency		
6-3-22	003-034260	Transformer, Audio Frequency		
6-3-32	003-034261	Transformer, Audio Frequency		
6-3-1	003-034262	Transformer, Audio Frequency		
6-3-9	003-034263	Transformer, Audio Frequency		
6-3-17	003-034264	Transformer, Audio Frequency		
6-3-6	003-034265	Transformer, Audio Frequency		
6-3-14	003-034266	Transformer, Audio Frequency		
6-3-3	003-034267	Transformer, Audio Frequency		
6-3-11	003-034268	Transformer, Audio Frequency		
6-6-61	003-036229	Transformer, Audio Frequency		
6-6-62	003-036499	Transformer, Audio Frequency		
6-6-58	003-036753	Transformer Assembly (230 V 50 Hz only)		
6-11-2	003-036864	Filter, Audio Frequency		
6-11-1	003-036885	Transformer, Power Distribution (230 V 50 Hz only)		
6-5-14	005-015141	Connector, Receptacle, Electrical	78-55-021	American Phenolic Corporation
6-7-19	005-016328	Connector, Receptacle, Electrical	61M021	American Phenolic Corporation
6-2-1	008-016944	Switch, Toggle	86709G	Arrow-Hart & Hegeman Elect. Co.
6-7-27	008-020771	Contact, Electrical		
6-2-2	008-021901	Switch, Toggle	80605H	Arrow-Hart & Hegeman Elect. Co.
6-12-1	011-035752	Cable Assembly, Power, Electrical		
6-12-2	011-036408	Cable Assembly, Special Purpose, Electrical		
6-9-14	012-001800	Switch Pusher Assembly, Pedal		
6-13-1	012-002345	Spring, Helical, Extension		
6-1-47	012-020658	Spring, Toggle		
6-7-20	012-021865	Spring, Helical, Extension		
6-7-16	012-033227	Spring, Helical Extension	e	

REPAIR PARTS LIST (CONT)

FIGURE & INDEX NO.	HAMMOND PART NO.	DESCRIPTION	VENDOR OR MIL PART NO.	VENDOR OR SPEC
6-9-18	012-035585	Spring, Flat		
6-5-3	014-021270	Loudspeaker, Electromagnetic	19350-12C42	Rola Company
6-5-2	014-023421	Loudspeaker, Electromagnetic	68057860	Heppner Manufacturing Company
6-7-2	015-025581	Oil Tube Assembly		
6-7-3	016-022885	Lamp, Incandescent, 15/16", 6.3 V .15 amp, 2-pin miniature	12	General Electric Company
6-2-6	016-031453	Lens, Indicator Light		
6-7-5	016-035704	Lamp, Incandescent	MS15554-1	Hyland Electric Company
6-7-4	016-035817	Fixture, Lighting		
6-2-4	016-036411	Lampholder Assembly		
6-7-6	020-016265	Tube, Wiring		
5-3	021-035137	Motor & Pinion Assembly, Starting (115 V 60 Hz only)		
6-13-2				
5-3	021-035140	Motor & Pinion Assembly, Starting (230 V 50 Hz only)		
6-13-2				
6-9-13	025-001698	Cap, Black Pedal		
6-2-5	025-002071	Bat Handle, Switch		
6-1-17	025-002619	Short Manual Key		
6-1-36	025-023309	End Block		
6-1-37	025-023310	End Block		
6-9-17	025-034727	Bumper, Molded	Y3010	Minnesota Mining and Manufacturing Company
6-1-1	025-035666	White Key C		
6-1-2	025-035667	White Key D		
6-1-3	025-035668	White Key E		
6-1-4	025-035669	White Key F		
6-1-5	025-035670	White Key G		
6-1-6	025-035671	White Key A		
6-1-7	025-035672	White Key B		
6-1-9	025-035673	White Key CX		
6-1-16	025-035676	Key C		
6-1-15	025-035677	Key D		
6-1-14	025-035678	Key E		
6-1-13	025-035679	Key F		
6-1-12	025-035680	Key G		
6-1-11	025-035681	Key A		
6-1-10	025-035682	Key B		
6-1-18	025-036036	Tab, Switch		
6-1-19	025-036037	Tab, Switch		
6-1-20	025-036038	Tab, Switch		
6-1-24	025-036081	Tab, Switch		
6-1-23	025-036082	Tab, Switch		
6-1-21	025-036083	Tab, Switch		
6-1-22	025-036084	Tab, Switch		
6-1-8	025-036295	Sharp Key, Manual	BLACK6011	Rohm & Hass Company

REPAIR PARTS LIST (CONT)

FIGURE & INDEX NO.	HAMMOND PART NO.	DESCRIPTION	VENDOR OR MIL PART NO.	VENDOR OR SPEC
6-1-25	031-023557	Knob		
6-1-26	031-034331	Knob		
6-1-28	031-034333	Knob		
6-1-35	031-034334	Knob		
6-1-27	031-034337	Knob		
6-1-29	031-0338	Knob		
6-1-30	031-034339	Knob		
6-1-31	031-034340	Knob		
6-1-32	031-034341	Knob		
6-1-33	031-034342	Knob		
6-1-34	031-034343	Knob		
6-8-1	032-015772	Strike, Catch	227C1	National Lock Company
6-8-2	032-016267	Lock, Flush	2450	National Lock Company
Not Shown	032-016268	Key	B91LN	National Lock Company
6-7-17	032-020555	Screw, Eye		
6-7-14	041-032935	Cover, Line Panel		
6-10-10	042-001701	Stop, Felt	1955H (Bulk)	Chas. W. House & Sons
6-9-15	042-001720	Stop, Felt	1959 (Bulk)	Chas. W. House & Sons
6-9-16	042-001721	Stop, Felt	1842 (Bluk)	Chas. W. House & Sons
6-9-12	042-001911	Stop, Felt	142 (Bulk)	Chas. W. House & Sons
6-9-11	042-001912	Stop, Felt	142 (Bulk)	Chas. W. House & Sons
6-9-10	042-001914	Stop, Felt	142 (Bulk)	Chas. W. House & Sons
6-10-12	042-022369	Stop, Felt	7837Neutral (Bulk)	American Felt Company
6-10-11	042-022385	Stop, Felt	607 (Bulk)	Chas. W. House & Sons
6-7-7	043-031436	Mat, Rubber		
6-10-2	057-021236	Key Comb Assembly		
6-10-3	057-021237	Key Comb Assembly		
6-10-4	057-021238	Key Comb Assembly		
6-10-5	057-035832	Bracket & Channel Assembly		
6-10-6	057-035831	Bracket & Channel Assembly		
6-10-9	057-035833	Bracket & Channel Assembly		
6-10-8	057-035834	Bracket & Channel Assembly		
6-10-7	057-035835	Bracket & Channel Assembly		
6-7-21	060-021406	Lever & Bushing Assembly		
6-7-18	060-021652	Swell Capacitor Assembly		
6-10-1	060-021709	Cradle Spring & Bracket Assembly		
6-7-12	060-021732	Connecting Rod Assembly		
6-7-22	060-021751	Sleeve & Washer Assembly, Generator		
6-9-1	060-035564	White Pedal Assembly		
6-9-8	060-035589	Black Pedal Assembly		
6-9-7	060-035590	Black Pedal Assembly		
6-9-9	060-035591	Black Pedal Assembly		
6-9-6	060-035592	Black Pedal Assembly		
6-9-5	060-035593	Black Pedal Assembly		
6-9-4	060-035594	Black Pedal Assembly		
6-9-3	060-035595	Black Pedal Assembly		

REPAIR PARTS LIST (CONT)

FIGURE & INDEX NO.	HAMMOND PART NO.	DESCRIPTION	VENDOR OR MIL PART NO.	VENDOR OR SPEC
6-9-2	060-035596	Black Pedal Assembly		
6-1-42	060-036603	Stop Slider Assembly		
6-1-43	061-023546	Plate, Switch		
6-2-3	061-023547	Plate, Instruction		
6-1-39	061-035811	Front Strip Assembly		
6-1-38	061-035812	Front Strip Assembly		
6-7-15	063-035154	Line Panel Assembly		
6-13-3	064-035768	Drive Shaft Assembly Coupling		
6-8-3	104-000011	Bench Assembly		
6-13	112-000013	Generator & Motor Assembly (115 V 60 Hz only)		
6-13	112-000016	Generator & Motor Assembly (230 V 60 Hz only)		
3-2	116-000006	Pedal Switch Assembly		
6-7-26				
6-7-1	117-000005	Preamplifier Assembly (115 V 60 Hz only)		
6-7-1	117-000006	Preamplifier Assembly (230 V 50 Hz only)		
6-1-41	120-000008	Stop Switch Assembly		
6-7-13	121-000057	Synchronous Motor & Scanner (115 V 60 Hz only) Assembly		
6-7-13	121-000060	Synchronous Motor & Scanner (230 V 50 Hz only) Assembly		
6-5-4	121-000085	Reverberation Assembly		
6-7-8	123-000010	Swell Pedal Assembly		
6-1-45	125-000018	Control Switch Assembly		
6-1-46	125-000019	Vibrato Switch Assembly		
6-1-44	125-000023	Percussion Control Switch Assembly		
6-5-1	126-000010	Amplifier Assembly		
6-5-13	127-000013	Power Pack Assembly (115 V 60 Hz only)		
6-5-13	127-000015	Power Pack Assembly (230 V 50 Hz only)		
6-4-21	401-020262	Capacitor, Fixed, Film 0.010 μ F \pm 10% 200 Vdc	CTM103VCK	MIL-C-27287
6-4-23	401-020533	Capacitor, Fixed, Film 0.10 μ F \pm 10% 200 Vdc	CTM104VCK	MIL-C-27287
6-6-41	401-020652	Capacitor, Fixed, Film 0.33 μ F \pm 10% 200 Vdc	CTM334VBK	MIL-C-27287
6-6-39	401-020773	Capacitor, Fixed, Film 1.0 μ F \pm 20% 200 Vdc		
6-4-26	403-030452	Capacitor, Fixed, Film 0.047 μ F \pm 10% 400 Vdc	CTM473VDK	MIL-C-27287
6-6-36	403-030453	Capacitor, Fixed, Film 0.047 μ F \pm 20% 400 Vdc	CTM473VDK	MIL-C-27287
6-4-2	403-030612	Capacitor, Fixed, Film 0.22 μ F \pm 10% 400 Vdc	PKM4P22	Cornell-Dubilier Electric Corporation
6-6-18	403-030653	Capacitor, Fixed, Film 0.33 μ F \pm 20% 400 Vdc	PKM4P33	Cornell-Dubilier Electric Corporation
6-4-40	406-010042	Capacitor, Fixed, Film 0.0047 μ F \pm 10% 100 Vdc	CTM472VBK	MIL-C-27287
6-14-2	406-010072	Capacitor, Fixed, Film 0.010 μ F \pm 10% 100 Vdc	CTM103VBK	MIL-C-27287

REPAIR PARTS LIST (CONT)

FIGURE & INDEX NO.	HAMMOND PART NO.	DESCRIPTION	VENDOR OR MIL PART NO.	VENDOR OR SPEC
6-14-3	406-010222	Capacitor, Fixed, Film 0.0027 μ F $\pm 10\%$ 100 Vdc	CTM272VBK	MIL-C-27287
6-14-1	406-010252	Capacitor, Fixed, Film 0.0056 μ F $\pm 10\%$ 100 Vdc	CTM562VBK	MIL-C-27287
6-4-39	406-010142	Capacitor, Fixed, Film 0.10 μ F $\pm 10\%$ 100 Vdc	CTM104VBK	MIL-C-27287
6-4-43	407-010029	Capacitor, Fixed, Electrolytic 100 μ F +100% -10% 3 Vdc	30D-TE1059.5	Sprague Electric Company
6-4-28	407-080017	Capacitor, Fixed, Electrolytic 3 μ F +50% -20% 50 Vdc	30D-TE1302	Sprague Electric Company
6-4-44	413-010042	Capacitor, Fixed, Film 4700 pF $\pm 10\%$ 100 Vdc	P747211	The Electro Motive Man- ufacturing Company
6-4-54	413-010142	Capacitor, Fixed, Film 10000 pF $\pm 10\%$ 100 Vdc	P7104	The Electro Motive Man- ufacturing Company
6-4-37	420-010113	Capacitor, Fixed, Film 1 μ F $\pm 20\%$ 100 Vdc	CTM105VAK	MIL-C-27287
6-6-63	425-010101	Capacitor, Fixed, Ceramic 24 pF $\pm 5\%$ 500 Vdc		
6-6-49	425-010121	Capacitor, Fixed, Ceramic 30 pF $\pm 5\%$ 500 Vdc		
6-6-28	425-010151	Capacitor, Fixed, Ceramic 39 pF $\pm 5\%$ 500 Vdc		
6-6-50	425-010181	Capacitor, Fixed, Ceramic 50 pF $\pm 5\%$ 500 Vdc		
6-6-15	425-010232	Capacitor, Fixed, Ceramic 82 pF $\pm 5\%$ 500 Vdc		
6-4-14	425-010252	Capacitor, Fixed, Ceramic 100 pF $\pm 5\%$ 1000 Vdc	CK60BX101K	MIL-C-1015/9
6-4-59	425-010253	Capacitor, Fixed, Ceramic 100 pF $\pm 20\%$ 500 Vdc	CK61CZ101M	MIL-C-11015/10
6-6-43				
6-6-48	425-010292	Capacitor, Fixed, Ceramic 150 pF $\pm 10\%$ 500 Vdc	CK61CZ151K	MIL-C-11015/10
6-4-58	425-010293	Capacitor, Fixed, Ceramic 150 pF $\pm 20\%$ 500 Vdc	CK61CZ151M	MIL-C-11015/10
6-6-22	425-010333	Capacitor, Fixed, Ceramic 220 pF $\pm 20\%$ 500 Vdc	CK61BX221M	MIL-C-11015/10
6-6-44	425-010392	Capacitor, Fixed, Ceramic 390 pF $\pm 10\%$ 500 Vdc	DD391	Centralab, Div. of Globe- Union, Inc.
6-4-56	425-010412	Capacitor, Fixed, Ceramic 470 pF $\pm 10\%$ 500 Vdc	CK61BX471K	MIL-C-11015/10
6-7-47	425-010482	Capacitor, Fixed, Ceramic 820 pF $\pm 10\%$ 500 Vdc	CK62BX821K	MIL-C-11015
6-4-55	425-010503	Capacitor, Fixed, Ceramic 1000 pF $\pm 20\%$ 500 Vdc	CK63CZ102M	MIL-C-11015/12
6-6-16				
6-4-35	425-010522	Capacitor, Fixed, Ceramic 1200 pF $\pm 10\%$ 500 Vdc	CF122	Centralab, Div. of Globe- Union, Inc.
6-4-34	425-010542	Capacitor, Fixed, Ceramic 1500 pF $\pm 10\%$ 500 Vdc	CK62BX152K	MIL-C-11015/11
6-6-46				

REPAIR PARTS LIST (CONT)

FIGURE & INDEX NO.	HAMMOND PART NO.	DESCRIPTION	VENDOR OR MIL PART NO.	VENDOR OR SPEC
6-4-33	425-010582	Capacitor, Fixed, Ceramic 2200 pF ±10% 500 Vdc	CK62AX222K	MIL-C-11015/11
6-6-23	425-010583	Capacitor, Fixed, Ceramic 2200 pF ±20% 500 Vdc	CK61AW222M	MIL-C-11015/10
6-6-45	425-010623	Capacitor, Fixed, Ceramic 3300 pF ±20% 500 Vdc	CK63BX332M	MIL-C-11015/12
6-4-36	425-010662	Capacitor, Fixed, Ceramic 4700 pF ±10% 500 Vdc	CK62AW472K	MIL-C-11015/11
6-6-1	425-010663	Capacitor, Fixed, Ceramic 4700 pF ±20% 500 Vdc	CK62AW472M	MIL-C-11015/11
6-6-19	425-010746	Capacitor, Fixed, Ceramic .01 μF +100% -0% 500 Vdc	DD6-103	Centralab, Div. of Globe- Union, Inc.
6-4-1	425-010752	Capacitor, Fixed, Ceramic 10000 pF ±10% 500 Vdc	CF103	Centralab, Div. of Globe- Union, Inc.
6-4-12	425-010763	Capacitor, Fixed, Ceramic 20000 pF ±20% 500 Vdc	5HK-S20	Sprague Electric Company
6-6-17				
6-4-57	425-030583	Capacitor, Fixed, Ceramic 2200 pF ±20% 2000 Vdc	DD60-222	Centralab, Div. of Globe- Union, Inc.
6-11-4	450-010071	Capacitor, Fixed, Electrolytic 50 μF +50% -10% 450 Vdc		
6-6-57	450-030100	Capacitor, Fixed, Electrolytic 10, 50, 30, 30 mfd -10 +100% -10 +200% -10 +200% 310 V, 230 V, 14 V, 1.9 V		
6-6-40	450-040082	Capacitor, Fixed, Electrolytic 4000 μF +100% -10% 35 Vdc		
6-5-11	450-040200	Capacitor, Fixed, Electrolytic 3 section, 40 μF +50% -10% 450 Vdc, 40 μF +50% -10% 400 Vdc, 30 μF +100% -10% 350 Vdc		
6-6-56				
6-4-49	450-040302	Capacitor, Fixed, Electrolytic 4 section, 100 μF +250% -10% 25 Vdc, 100 μF +250% -10% 25 Vdc, 25 μF +250% -10% 25 Vdc, 25 μF +250% -10% 25 Vdc		
6-7-23	499-021468	Capacitor, Variable, Air Dielectric 4 to 70 pF with 20 pF ±20% fixed capacitor in parallel adjustable range 24 pF +0% -20% to 90 pF ±20%	5610089	The Electro Motive Man- ufacturing Company

REPAIR PARTS LIST (CONT)

FIGURE & INDEX NO.	HAMMOND PART NO.	DESCRIPTION	VENDOR OR MIL PART NO.	VENDOR OR SPEC
6-6-53	600-020091	Resistor, Fixed, Composition 22 ohms $\pm 10\%$ 1/2 W	RC20GF220K	MIL-R-11
6-6-8	600-020251	Resistor, Fixed, Composition 100 ohms $\pm 10\%$ 1/2 W	RC20GF101K	MIL-R-11
6-6-32	600-020311	Resistor, Fixed, Composition 180 ohms $\pm 10\%$ 1/2 W	RC20GF181K	MIL-R-11
6-4-46	600-020351	Resistor, Fixed, Composition 270 ohms $\pm 10\%$ 1/2 W	RC20GF271K	MIL-R-11
6-4-51	600-020431	Resistor, Fixed, Composition 560 ohms $\pm 10\%$ 1/2 W	RC20GF561K	MIL-R-11
6-6-7	600-020471	Resistor, Fixed, Composition 820 ohms $\pm 10\%$ 1/2 W	RC20GF821K	MIL-R-11
6-6-43	600-020511	Resistor, Fixed, Composition 1200 ohms $\pm 10\%$ 1/2 W	RC20GF122K	MIL-R-11
6-6-47	600-020531	Resistor, Fixed, Composition 1500 ohms $\pm 10\%$ 1/2 W	RC20GF152K	MIL-R-11
6-6-51	600-020571	Resistor, Fixed, Composition 2200 ohms $\pm 10\%$ 1/2 W	RC20GF222K	MIL-R-11
6-4-50	600-020611	Resistor, Fixed, Composition 3300 ohms $\pm 10\%$ 1/2 W	RC20GF332K	MIL-R-11
6-14-4	600-020631	Resistor, Fixed, Composition 3900 ohms $\pm 10\%$ 1/2 W	RC20GF392K	MIL-R-11
6-4-16	600-020651	Resistor, Fixed, Composition 4700 ohms $\pm 10\%$ 1/2 W	RC20GF472K	MIL-R-11
6-6-13	600-020731	Resistor, Fixed, Composition 10 K ohms $\pm 10\%$ 1/2 W	RC20GF103K	MIL-R-11
6-4-9	600-020771	Resistor, Fixed, Composition 15 K ohms $\pm 10\%$ 1/2 W	RC20GF153K	MIL-R-11
6-4-45	600-020791	Resistor, Fixed, Composition 18 K ohms $\pm 10\%$ 1/2 W	RC20GF183K	MIL-R-11
6-14-5	600-020811	Resistor, Fixed, Composition 22 K ohms $\pm 10\%$ 1/2 W	RC20GF223K	MIL-R-11
6-6-52	600-020851	Resistor, Fixed, Composition 33 K ohms $\pm 10\%$ 1/2 W	RC20GF333K	MIL-R-11
6-4-27	600-020891	Resistor, Fixed, Composition 47 K ohms $\pm 10\%$ 1/2 W	RC20GF473K	MIL-R-11
6-4-42	600-020931	Resistor, Fixed, Composition 68 K ohms $\pm 10\%$ 1/2 W	RC20GF683K	MIL-R-11
6-6-9	600-020951	Resistor, Fixed, Composition 82 K ohms $\pm 10\%$ 1/2 W	RC20GF823K	MIL-R-11
6-4-27	600-020971	Resistor, Fixed, Composition 0.1 megohms $\pm 10\%$ 1/2 W	RC20GF104K	MIL-R-11
6-6-54	600-021011	Resistor, Fixed, Composition 0.15 megohms $\pm 10\%$ 1/2 W	RC20GF154K	MIL-R-11
6-6-3	600-021031	Resistor, Fixed, Composition 0.18 megohms $\pm 10\%$ 1/2 W	RC20GF184K	MIL-R-11

REPAIR PARTS LIST (CONT)

FIGURE & INDEX NO.	HAMMOND PART NO.	DESCRIPTION	VENDOR OR MIL PART NO.	VENDOR OR SPEC
6-4-38	600-021051	Resistor, Fixed, Composition 0.22 megohms $\pm 10\%$ 1/2 W	RC20GF224K	MIL-R-11
6-4-18	600-021071	Resistor, Fixed, Composition 0.27 megohms $\pm 10\%$ 1/2 W	RC20GF274K	MIL-R-11
6-6-12	600-021091	Resistor, Fixed, Composition 0.33 megohms $\pm 10\%$ 1/2 W	RC20GF334K	MIL-R-11
6-4-30	600-021091	Resistor, Fixed, Composition 0.33 megohms $\pm 10\%$ 1/2 W	RC20GF334K	MIL-R-11
6-6-10	600-021111	Resistor, Fixed, Composition 0.39 megohms $\pm 10\%$ 1/2 W	RC20GF394K	MIL-R-11
6-6-4	600-021111	Resistor, Fixed, Composition 0.39 megohms $\pm 10\%$ 1/2 W	RC20GF394K	MIL-R-11
6-6-24	600-021131	Resistor, Fixed, Composition 0.47 megohms $\pm 10\%$ 1/2 W	RC20GF474K	MIL-R-11
6-6-34	600-021132	Resistor, Fixed, Composition 0.47 megohms $\pm 5\%$ 1/2 W	RC20GF474J	MIL-R-11
6-4-31	600-021151	Resistor, Fixed, Composition 0.56 megohms $\pm 10\%$ 1/2 W	RC20GF564K	MIL-R-11
6-4-22	600-021171	Resistor, Fixed, Composition 0.68 megohms $\pm 10\%$ 1/2 W	RC20GF684K	MIL-R-11
6-4-26	600-021191	Resistor, Fixed, Composition 0.82 megohms $\pm 10\%$ 1/2 W	RC20GF824K	MIL-R-11
6-6-27	600-021211	Resistor, Fixed, Composition 1 megohms $\pm 10\%$ 1/2 W	RC20GF105K	MIL-R-11
6-6-2	600-021211	Resistor, Fixed, Composition 1 megohms $\pm 10\%$ 1/2 W	RC20GF105K	MIL-R-11
6-4-41	600-021231	Resistor, Fixed, Composition 1.2 megohms $\pm 10\%$ 1/2 W	RC20GF125K	MIL-R-11
6-6-29	600-021271	Resistor, Fixed, Composition 1.8 megohms $\pm 10\%$ 1/2 W	RC20GF185K	MIL-R-11
6-6-25	600-021291	Resistor, Fixed, Composition 2.2 megohms $\pm 10\%$ 1/2 W	RC20GF225K	MIL-R-11
6-4-32	600-021311	Resistor, Fixed, Composition 2.7 megohms $\pm 10\%$ 1/2 W	RC20GF275K	MIL-R-11
6-6-33	600-021331	Resistor, Fixed, Composition 3.3 megohms $\pm 10\%$ 1/2 W	RC20GF335K	MIL-R-11
6-4-13	600-021331	Resistor, Fixed, Composition 3.3 megohms $\pm 10\%$ 1/2 W	RC20GF335K	MIL-R-11
6-6-30	600-021371	Resistor, Fixed, Composition 4.7 megohms $\pm 10\%$ 1/2 W	RC20GF475K	MIL-R-11
6-6-35	600-021451	Resistor, Fixed, Composition 10 megohms $\pm 10\%$ 1/2 W	RC20GF106K	MIL-R-11
6-6-26	600-021452	Resistor, Fixed, Composition 10 megohms $\pm 5\%$ 1/2 W	RC20GF106J	MIL-R-11
6-6-11	600-021460	Resistor, Fixed, Composition 15 megohms $\pm 10\%$ 1/2 W	RC20GF156K	MIL-R-11
6-6-55	600-030571	Resistor, Fixed, Composition 2200 ohms $\pm 10\%$ 1 W	RC32GF220K	MIL-R-11
6-6-31	600-030591	Resistor, Fixed, Composition 2700 ohms $\pm 10\%$ 1 W	RC32GF272K	MIL-R-11
6-6-6	600-030651	Resistor, Fixed, Composition 2700 ohms $\pm 10\%$ 1W	RC32GF272K	MIL-R-11
6-4-10	600-030671	Resistor, Fixed, Composition 5600 ohms $\pm 10\%$ 1W	RC32GF562K	MIL-R-11

REPAIR PARTS LIST (CONT)

FIGURE & INDEX NO.	HAMMOND PART NO.	DESCRIPTION	VENDOR OR MIL PART NO.	VENDOR OR SPEC
6-4-53	600-030731	Resistor, Fixed, Composition 10 K ohms $\pm 10\%$ 1 W	RC32GF103K	MIL-R-11
6-6-5	600-030811	Resistor, Fixed, Composition 22 K ohms $\pm 10\%$ 1W	RC32GF223K	MIL-R-11
6-4-19	600-030931	Resistor, Fixed, Composition 68 K ohms $\pm 10\%$ 1 W	RC32GF683K	MIL-R-11
6-4-7	600-030971	Resistor, Fixed, Composition 0.1 megohms $\pm 10\%$ 1 W	RC32GF104K	MIL-R-11
6-4-11	600-030991	Resistor, Fixed, Composition 0.12 megohms $\pm 10\%$ 1W	RC32GF124K	MIL-R-11
6-4-4	602-050042	Resistor, Fixed, Film 130 ohms $\pm 5\%$ 3 W	CRT35100	Central Resistor Corporation
6-4-8	602-050061	Resistor, Fixed, Film 250 ohms $\pm 10\%$ 3 W	CRT312500	Central Resistor Corporation
6-4-3	602-050072	Resistor, Fixed, Film 270 ohms $\pm 5\%$ 3 W	CRT352700	Central Resistor Corporation
6-4-5	603-060101	Resistor, Fixed, Wire Wound 100 ohms $\pm 10\%$ 5 W		
6-6-14	604-070421	Resistor, Fixed, Wire Wound 900 ohms $\pm 10\%$ 10 W		
6-6-20	604-070701	Resistor, Fixed, Wire Wound 4500 ohms $\pm 10\%$ 10 W		
6-11-3	604-070771	Resistor, Fixed, Wire Wound 6 K ohms $\pm 10\%$ 10 W		
6-6-21	604-070841	Resistor, Fixed, Wire Wound 7500 ohms $\pm 10\%$ 10 W		
6-4-52	676-000107	Resistor, Variable 1 K ohms $\pm 20\%$ 1/2 W		
6-6-37	676-000124	Resistor, Variable 30 K ohms $\pm 20\%$ 1/2 W	BA811-4692	Centrallab, Div. of Globe- Union, Inc.
6-6-38	676-000126	Resistor, Variable 300 K ohms $\pm 10\%$ 1/4 W	BA811-4754	Centrallab, Div. of Globe- Union, Inc.
	824-000003	Screw, Machine Hexagon Head, 10-32 by 1-1/2, Steel, Cadmium Plated		
6-7-11	999-001097	Nut, Plain, Hexagon 6-32 by 7/64 Thick, Steel, Cadmium Plated		
6-7-10	999-001413	Nut, Shouldered		
6-7-28	999-006007	Thumbscrew		

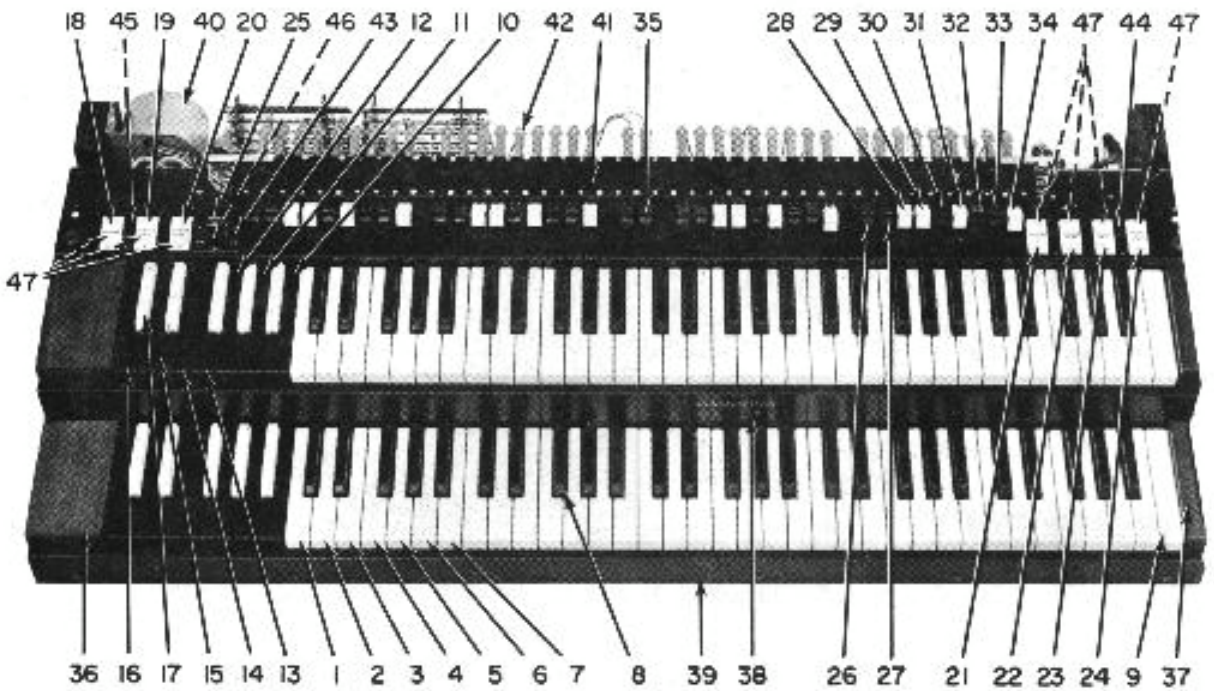

Figure 6-1. Manual Assembly, Complete

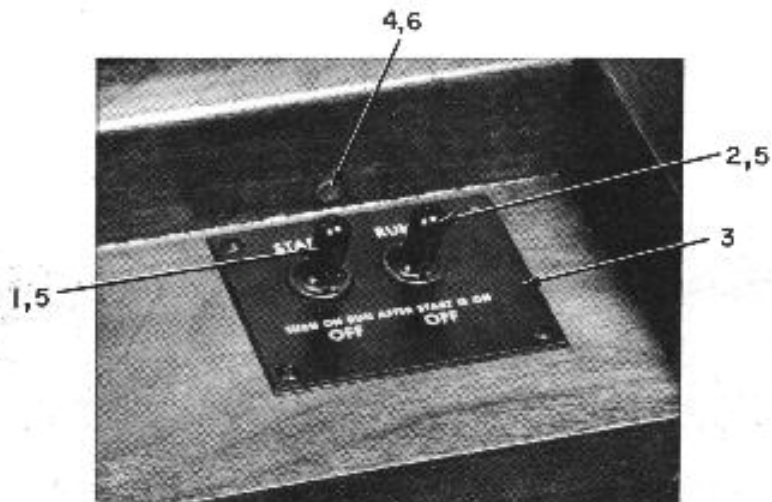

Figure 6-2. Control Panel, Upper Left End

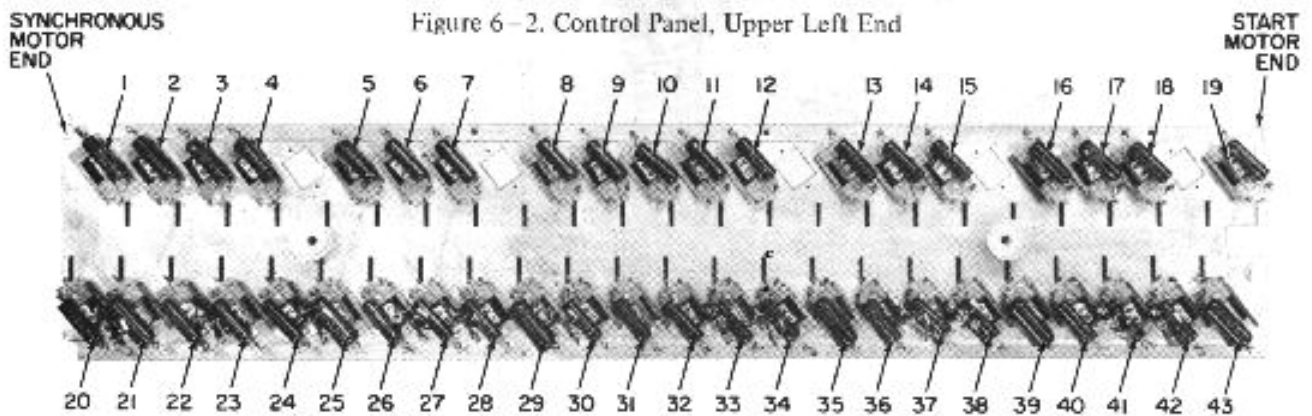

Figure 6-3. Generator Cover

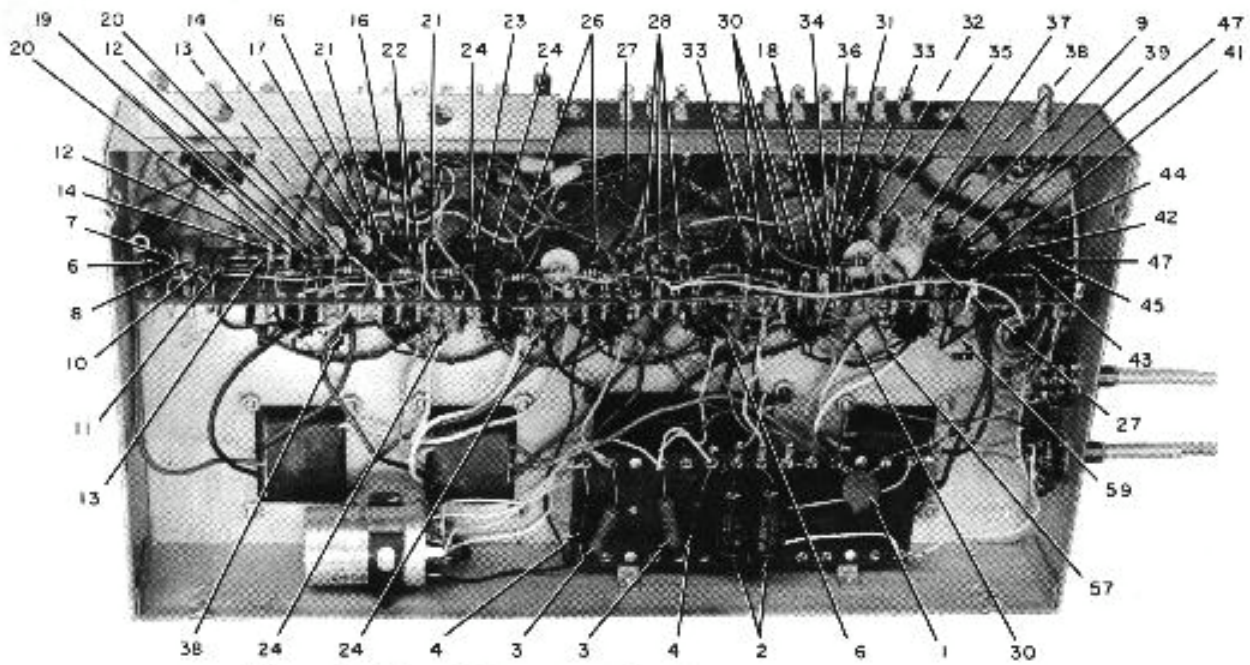

Figure 6-4. Tone Cabinet Amplifier, 126-000010, Sheet 1 of 2

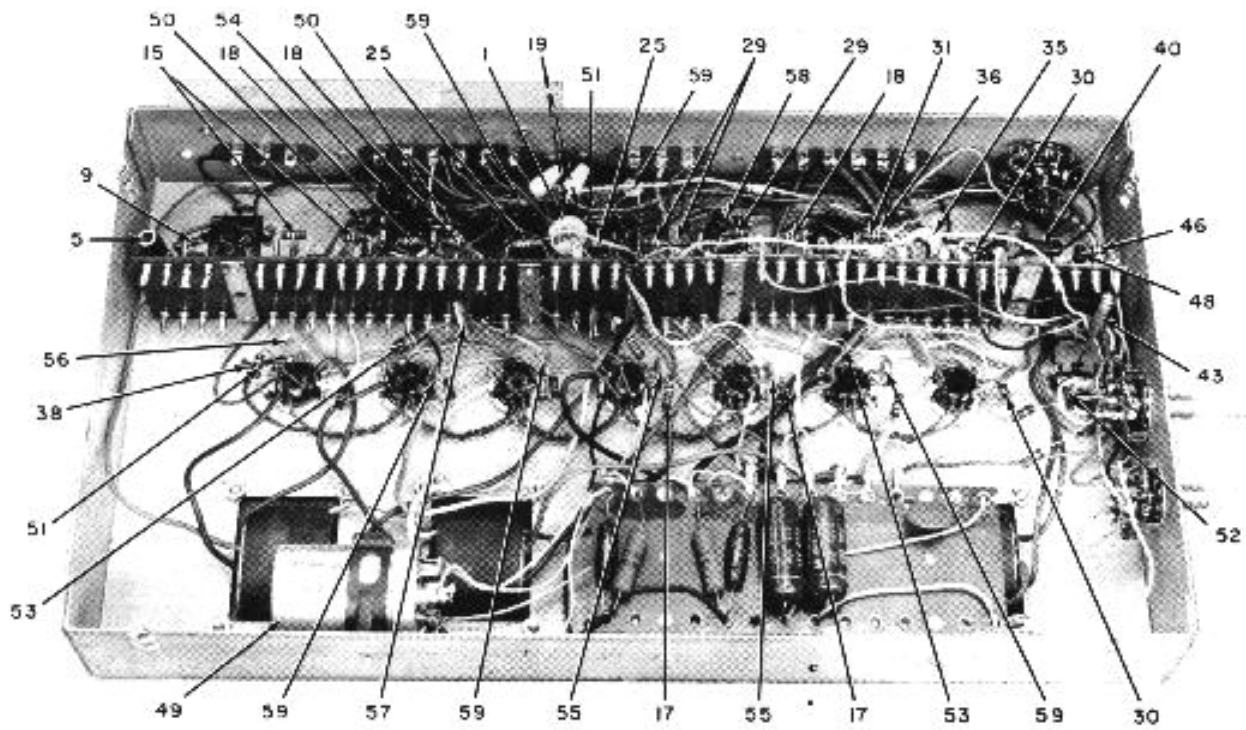

Figure 6-4. Tone Cabinet Amplifier, 126-000010, Sheet 2 of 2

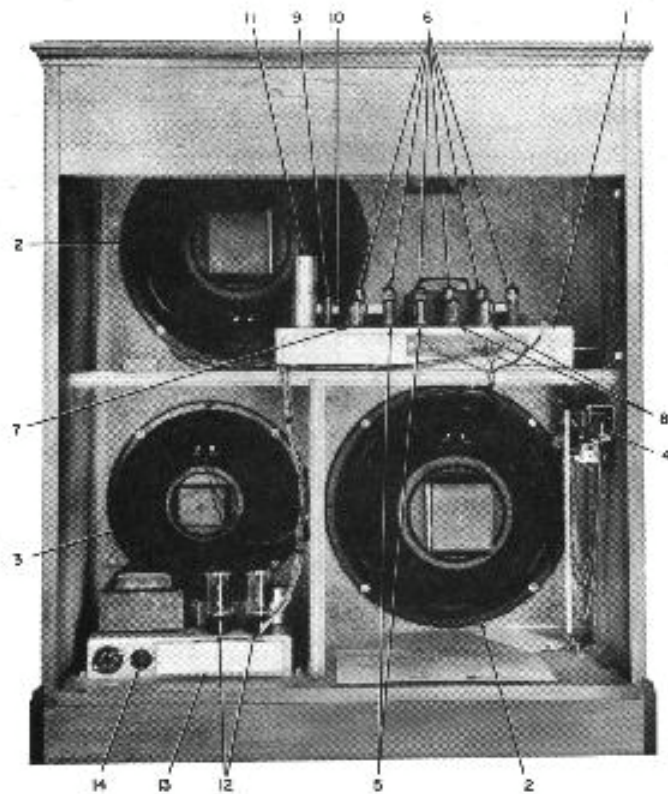

Figure 6-5. PR-40 Tone Cabinet, Rear View

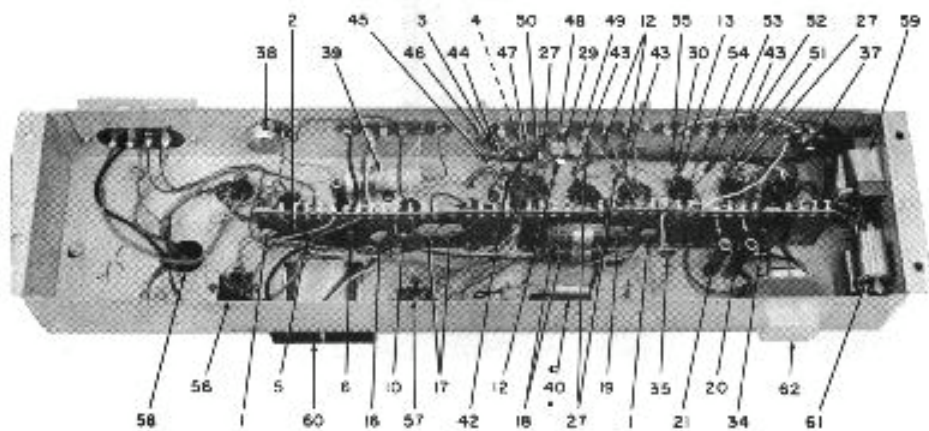

Figure 6-6. Preamplifier, 117-000005, Sheet 1 of 2

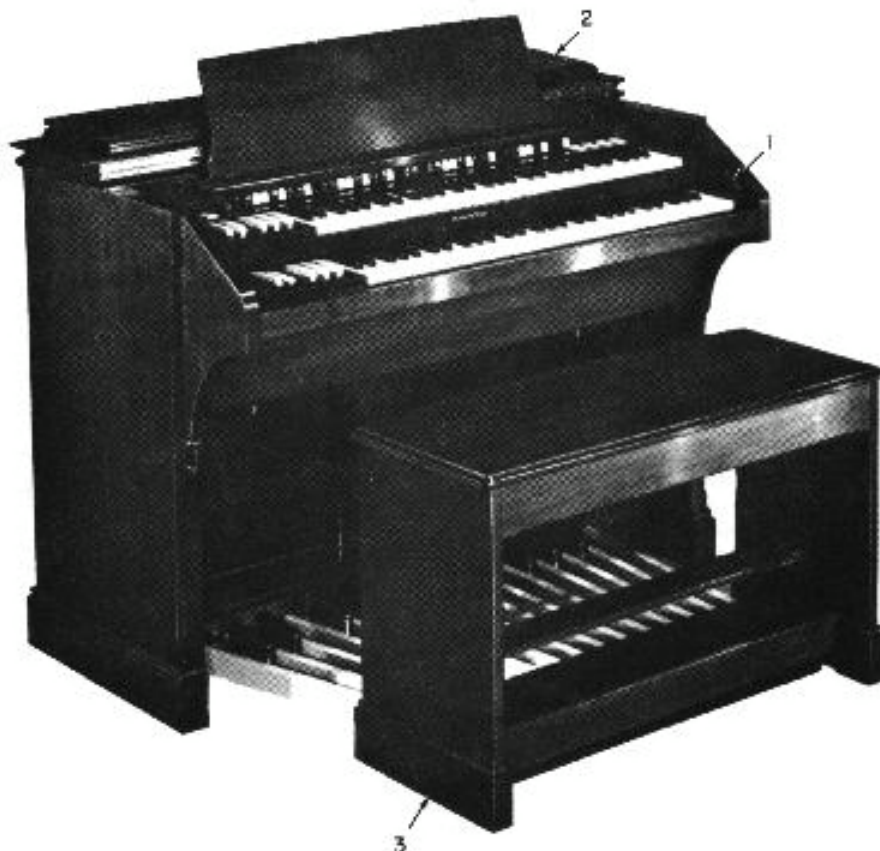

Figure 6-8. Console with Bench

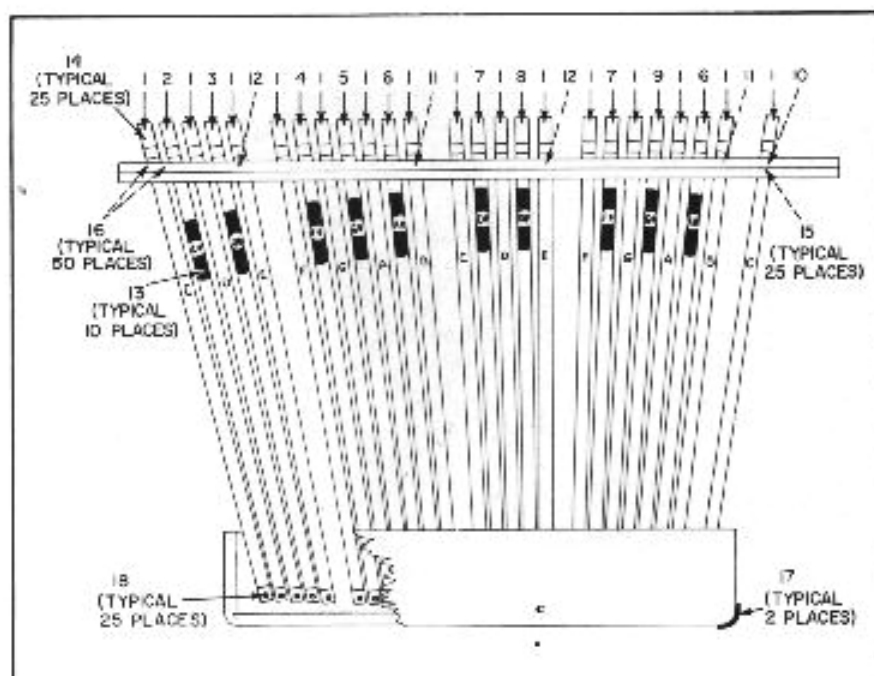

Figure 6-9. Pedal Switch Assembly, 116-00006

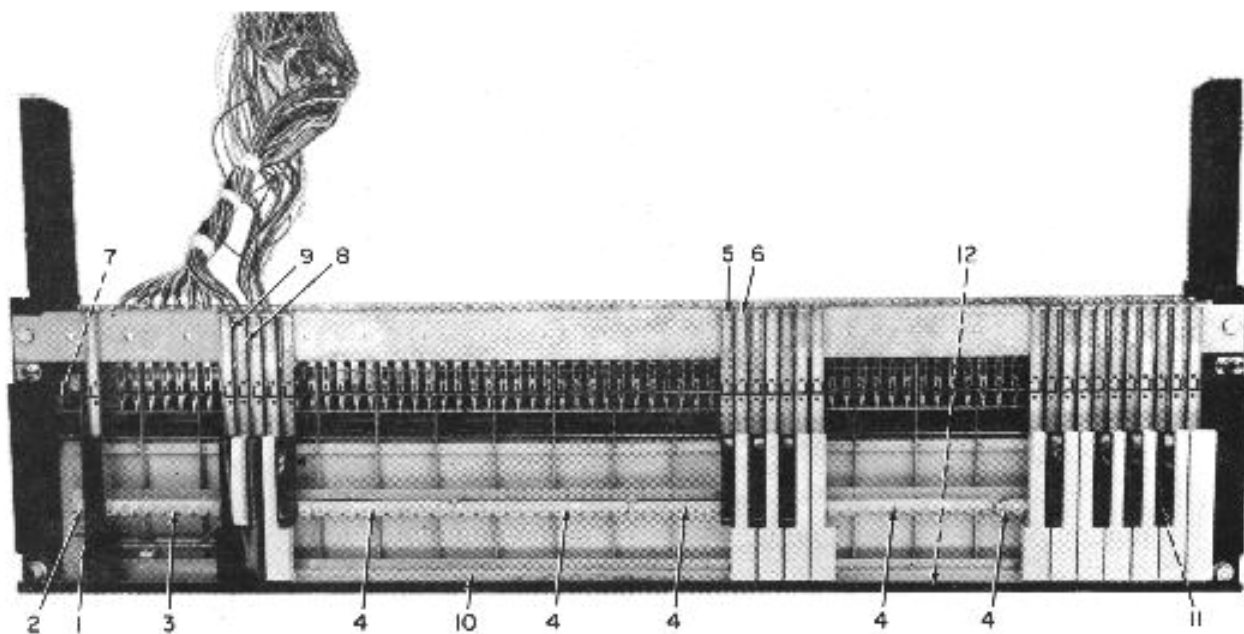

Figure 6-10. Lower Manual, Partially Disassembled

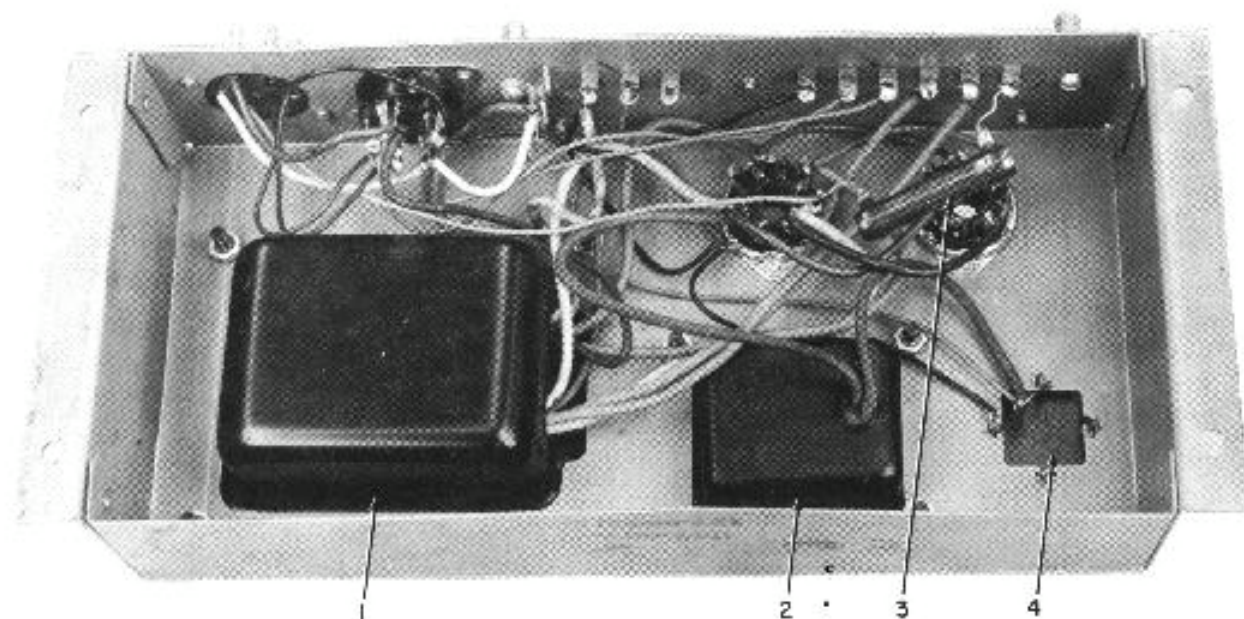

Figure 6-11. Power Pack Assembly, 127-000013

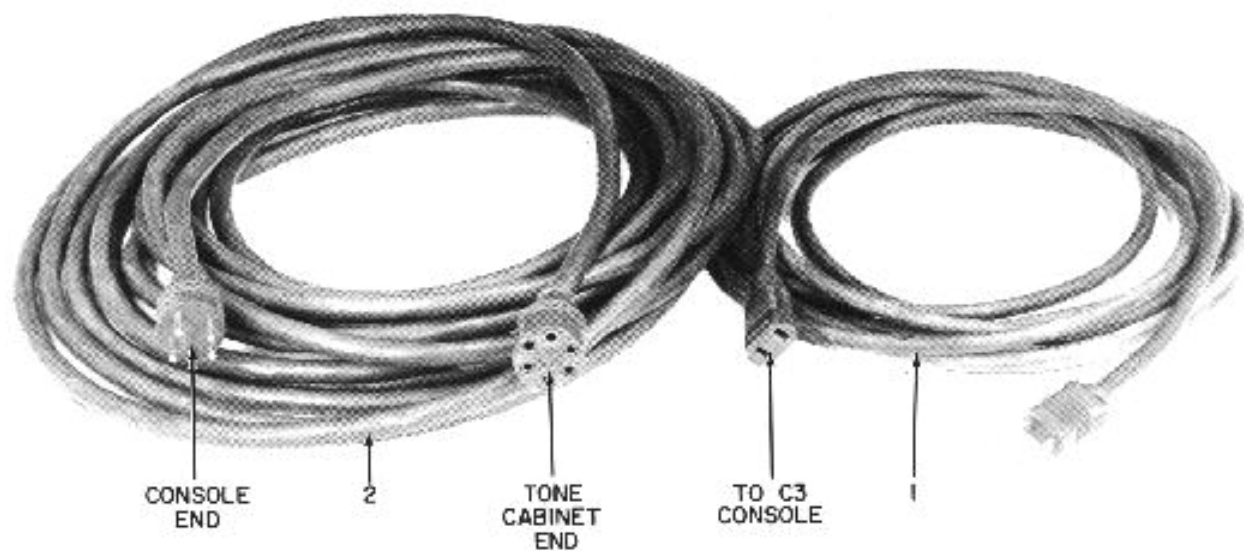

Figure 6-12. Interconnecting Cables

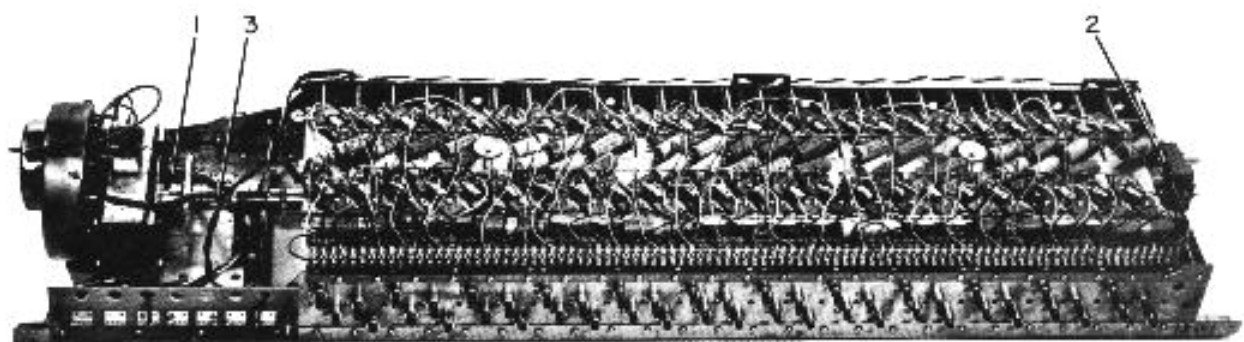

Figure 6-13. Generator & Motor Assembly, 112-000013

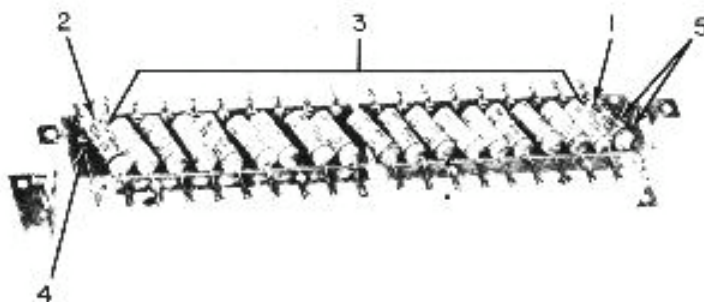

Figure 6-14. Vibrato Line Assembly (Located on Rear of Upper Manual)

APPENDIX A

CROSS REFERENCE INDEX

HAMMOND PART NUMBERS, NEW TO OLD

NEW PART NO.	OLD PART NO.	NEW PART NO.	OLD PART NO.
002-005201		003-034257	A0-24692-80
002-006201		003-034258	A0-24692-81
002-006300		003-034259	A0-24692-82
002-006500		003-034260	A0-24692-83
002-006700		003-034261	A0-24692-84
002-012300		003-034262	A0-24692-85
002-012301		003-034263	A0-24692-86
002-012302		003-034264	A0-24692-87
003-022020	A0-22020	003-034265	A0-24692-88
003-024112	A0-24112-0	003-034266	A0-24692-89
003-024891	A0-24891-1	003-034267	A0-24692-90
003-024895	A0-24895	003-034268	A0-24692-91
003-025327	A0-25327-0	003-036229	A0-22061-1
003-025417	A0-25417-1	003-036499	A0-24113-1
003-034226	A0-24692-49	003-036683	A0-24692-44
003-034227	A0-24692-50	003-036684	A0-24692-45
003-034228	A0-24692-51	003-036685	A0-24692-46
003-034229	A0-24692-52	003-036687	A0-24692-47
003-034230	A0-24692-53	003-036689	A0-24692-48
003-034231	A0-24692-54	003-036753	A0-24891-2
003-034232	A0-24692-55	003-036864	A0-25319-0
003-034233	A0-24692-56	005-015141	A0-15141-0
003-034234	A0-24692-57	005-016328	A0-16328-0
003-034235	A0-24692-58	008-016944	A0-16944-0
003-034236	A0-24692-59	008-020771	A0-020771-0
003-034237	A0-24692-60	008-021901	A0-21901-0
003-034238	A0-24692-61	011-035752	A0-15301
003-034239	A0-24692-62	011-036408	A0-23516-1
003-034240	A0-24692-63	012-001800	A0-1800-0
003-034241	A0-24692-64	012-001345	P0-2345-0
003-034242	A0-24692-65	012-020658	P0-20658-0
003-034243	A0-24692-66	012-021865	P0-21865-0
003-034244	A0-24692-67	012-033227	P0-21688-0
003-034245	A0-24692-68	012-035585	P0-2031
003-034246	A0-24692-69	014-021270	A0-21270
003-034247	A0-24692-70	014-023421	A0-23421-0
003-034248	A0-24692-71	015-025581	A0-25581-0
003-034249	A0-24692-72	016-022885	P0-22885-0
003-034250	A0-24692-73	016-031453	P0-23988-2
003-034251	A0-24692-74	016-035704	P0-16278-0
003-034252	A0-24692-75	016-035817	A0-16288-2
003-034253	A0-24692-76	016-036411	A0-23539-1
003-034254	A0-24692-77	020-016265	P0-16265-0
003-034255	A0-24692-78	021-035137	A0-2344-6
003-034256	A0-24692-79	021-035140	A0-2344-10

CROSS REFERENCE INDEX (CONT)
HAMMOND PART NUMBERS, NEW TO OLD

NEW PART NO.	OLD PART NO.	NEW PART NO.	OLD PART NO.
025-001698	P0-1698-0	042-001721	P0-1721-0
025-002071	P0-2071-1	042-001911	P0-1911-0
025-002619	P0-2619-2	042-001912	P0-1912-0
025-023309	P0-23309-0	042-001914	P0-1914-0
025-023310	P0-23310-0	042-022369	P0-22369-0
025-034727		042-022384	P0-22384-0
025-035666	P0-2638-C	042-022385	P0-22385-0
025-035667	P0-2638-D	043-031436	P0-21728-0
025-035668	P0-2638-E	057-021236	A0-21236-0
025-035669	P0-2638-F	057-021237	A0-21237-2
025-035670	P0-2638-G	057-021238	A0-21238-2
025-035671	P0-2638-A	057-023322	A0-23322-2
025-035672	P0-2368-B	057-035831	A0-16480-1
025-035673	P0-2638-CX	057-035833	A0-16480-3
025-035676	P0-2639-C	057-035834	A0-16480-4
025-035677	P0-2639-D	057-035835	A0-16480-5
025-035678	P0-2639-E	060-021406	A0-21406-0
025-035679	P0-2639-F	060-021652	A0-21652-2
025-035680	P0-2639-G	060-021709	A0-21709
025-035681	P0-2639-A	060-021732	A0-21732-0
025-035682	P0-2639-B	060-021751	A0-21751
025-036036	P0-21391-1	060-035564	A0-1801
025-036037	P0-21391-2	060-035589	A0-1798-1
025-036038	P0-21391-3	060-035590	A0-1798-3
025-036081	P0-21914-1	060-035591	A0-1798-5
025-036082	P0-21914-2	060-035592	A0-1798-7
025-036083	P0-21914-3	060-035593	A0-1798-9
025-036084	P0-21914-4	060-035594	A0-1798-11
025-036295	P0-22931-1	060-035595	A0-1798-15
031-023557	P0-23557-1	060-035596	A0-1798-17
031-034331	A0-32135-1	060-036603	-
031-034333	A0-32135-3	061-023546	P0-23546-0
031-034334	A0-32135-4	061-023547	P0-23547-0
031-034337	A0-32135-7	061-035811	A0-15912-1
031-034338	A0-32135-8	061-035812	A0-15912-2
031-034339	A0-32135-9	063-035154	A0-20164-1
031-034340	A0-32135-10	064-035768	A0-15846-0
031-034341	A0-32135-11	104-000011	A0-16300-2
031-034342	A0-32135-12	112-000013	A0-22065-5
031-034343	A0-32135-13	112-000016	A0-22065-8
032-015772	P0-15772-1	116-000006	A0-1822-11
032-016267	A0-16267-1	117-000005	A0-28-1
032-016268	P0-16268-001	117-000006	A0-28-2
032-020555	P0-20555-4	120-000008	A0-21895-1
041-032935	P0-20172-0	121-000057	A0-21880-9
042-001701	P0-1701-0	121-000060	A0-21880-12
042-001720	P0-1720-0	121-000085	A0-23270-1

CROSS REFERENCE INDEX (CONT)
HAMMOND PART NUMBERS, NEW TO OLD

NEW PART NO.	OLD PART NO.	NEW PART NO.	OLD PART NO.
123-000010	A0-21750-2	425-010623	A0-605-34
125-000018	A0-21390-3	425-010662	A0-605-69
125-000019	A0-21395	425-010663	A0-605-35
125-000023	A0-21930-3	425-010746	A0-605-145
126-000010	A0-33-3	425-010752	A0-605-146
127-000013	A0-32-1	425-010763	A0-605-153
401-020262	A0-501-49	425-030583	A0-605-300
401-020533	A0-501-19	450-010071	A0-20996-1
401-020652	A0-501-67	450-030100	A0-21986-0
401-020773	A0-501-169	450-040082	A0-26387-1
403-030452	A0-503-57	450-040200	A0-2201-0
403-030453	A0-503-17	450-040201	A0-22753-0
403-030612	A0-503-65	450-040302	A0-23497-0
403-030653	A0-503-22	499-021468	A0-21468-0
406-010042	A0-506-3	600-020011	-
406-010072	A0-506-006	600-020091	A0-20305-42
406-010142	A0-506-13	600-020170	-
406-010232	A0-506-022	600-020251	A0-20305-050
406-010252	A0-506-024	600-020291	-
406-210142	-	600-020311	A0-20305-53
406-210192	-	600-020351	A0-20305-55
407-010029	A0-507-1	600-020410	-
407-080017	A0-507-0	600-020431	A0-20305-59
413-010042	A0-513-3	600-020471	A0-20305-061
413-010142	A0-513-13	600-020511	A0-20305-63
414-110203	-	600-020531	A0-20305-64
420-010113	A0-505-10	600-020571	A0-20305-66
425-010081	A0-605-080	600-020611	A0-20305-68
425-010101	A0-605-82	600-020631	-
425-010121	A0-605-84	600-020651	A0-20305-70
425-010151	A0-605-87	600-020731	A0-20305-74
425-010181	A0-605-90	600-020751	-
425-010232	A0-605-048	600-020771	A0-20305-76
425-010252	A0-605-49	600-020791	A0-20305-77
425-010253	A0-605-25	600-020811	A0-20305-78
425-010292	A0-605-51	600-020851	A0-20305-80
425-010293	A0-605-26	600-020891	A0-20305-82
425-010333	A0-605-27	600-020931	A0-20305-84
425-010392	A0-605-56	600-020951	A0-20305-85
425-010412	A0-605-57	600-020971	A0-20305-86
425-010463	A0-605-030	600-020991	-
425-010482	A0-605-060	600-021011	A0-20305-88
425-010500	A0-605-13	600-021031	A0-20305-89
425-010503	A0-605-31	600-021051	A0-20305-90
425-010522	A0-605-62	600-021071	A0-20305-91
425-010542	A0-605-63	600-021091	A0-20305-92
425-010582	A0-605-65	600-021111	A0-20305-93
425-010583	A0-605-33	600-021131	A0-20305-94
		600-021132	A0-20305-223

CROSS REFERENCE INDEX (CONT)
HAMMOND PART NUMBERS, NEW TO OLD

NEW PART NO.	OLD PART NO.	NEW PART NO.	OLD PART NO.
600-021151	A0-20305-95		
600-021171	A0-20305-96		
600-021191	A0-20305-97		
600-021211	A0-20305-98		
600-021231	A0-20305-99		
600-021251	A0-20305-100		
600-021271	A0-20305-101		
600-021291	A0-20305-102		
600-021311	A0-20305-103		
600-021331	A0-20305-104		
600-021371	A0-20305-106		
600-021451	A0-20305-110		
600-021452	A0-20305-255		
600-021460	A0-20305-256		
600-030571	A0-20290-066		
600-030591	A0-20290-67		
600-030651	A0-20290-070		
600-030671	A0-20290-71		
600-030731	A0-20290-74		
600-030811	A0-20290-078		
600-030931	A0-20290-84		
600-030971	A0-20290-86		
600-030991	A0-20290-87		
602-050042	A0-22566-10		
602-050061			
602-050072	A0-22566-22		
603-060101	A0-18933-10		
604-070151	A0-19124-15		
604-070421	A0-19124-042		
604-070701	A0-19124-70		
604-070771	A0-19124-77		
604-070841	A0-19124-84		
626-060591			
676-000107	A0-20293-7		
676-000124	A0-20293-24		
676-000126	A0-20293-26		
824-000003	S-10514-4		
999-001097	-		
999-001413	PO-1749-4		
999-006007			

APPENDIX B

CROSS REFERENCE INDEX

HAMMOND PART NUMBERS, OLD TO NEW

OLD PART NO.	NEW PART NO.	OLD PART NO.	NEW PART NO.
A0-020771-0	008-020771	A0-20305-101	600-021271
A0-15141-0	005-015141	A0-20305-102	600-021291
A0-15301	011-035752	A0-20305-103	600-021311
A0-15846-0	064-035768	A0-20305-104	600-021331
A0-15912-1	061-035811	A0-20305-106	600-021371
A0-15912-2	061-035812	A0-20305-110	600-021451
A0-16267-1	032-016267	A0-20305-223	600-021132
A0-16288-2	016-035817	A0-20305-255	600-021452
A0-16300-2	104-000011	A0-20305-256	600-021460
A0-16328-0	005-016328	A0-20305-42	600-020091
A0-16480-1	057-035831	A0-20305-53	600-020311
A0-16480-3	057-035833	A0-20305-55	600-020351
A0-16480-4	057-035834	A0-20305-59	600-020431
A0-16480-5	057-035835	A0-20305-63	600-020511
A0-16944-0	008-016944	A0-20305-64	600-020531
A0-1798-1	060-035589	A0-20305-66	600-020571
A0-1798-11	060-035594	A0-20305-68	600-020611
A0-1798-15	060-035595	A0-20305-70	600-020651
A0-1798-17	060-035596	A0-20305-74	600-020731
A0-1798-3	060-035590	A0-20305-76	600-020771
A0-1798-5	060-035591	A0-20305-77	600-020791
A0-1798-7	060-035592	A0-20305-78	600-020811
A0-1798-9	060-035593	A0-20305-80	600-020851
A0-1800-0	012-001800	A0-20305-82	600-020891
A0-1801	060-035564	A0-20305-84	600-020931
A0-1822-11	116-000006	A0-20305-85	600-020951
A0-18933-10	603-060101	A0-20305-86	600-020971
A0-19124-042	604-070421	A0-20305-88	600-021011
A0-19124-15	604-070151	A0-20305-89	600-021031
A0-19124-70	604-070701	A0-20305-90	600-021051
A0-19124-77	604-070771	A0-20305-91	600-021071
A0-19124-84	604-070841	A0-20305-92	600-021091
A0-20164-1	063-035154	A0-20305-93	600-021111
A0-20290-066	600-030571	A0-20305-94	600-021131
A0-20290-070	600-030651	A0-20305-95	600-021151
A0-20290-078	600-030811	A0-20305-96	600-021171
A0-20290-67	600-030591	A0-20305-97	600-021191
A0-20290-71	600-030671	A0-20305-98	600-021211
A0-20290-74	600-030731	A0-20305-99	600-021231
A0-20290-84	600-030931	A0-20996-1	450-010071
A0-20290-86	600-030971	A0-21236-0	057-021236
A0-20290-87	600-030991	A0-21237-2	057-021237
A0-20293-24	676-000124	A0-21238-2	057-021238
A0-20293-26	676-000126	A0-21270	014-021270
A0-20293-7	676-000107	A0-21390-3	125-000018
A0-20305-050	600-020251	A0-21395	125-000019
A0-20305-061	600-020471	A0-21406-0	060-021406
A0-20305-100	600-021251	A0-21468-0	499-021468

CROSS REFERENCE INDEX (CONT)
HAMMOND PART NUMBERS, OLD TO NEW

OLD PART NO.	NEW PART NO.	OLD PART NO.	NEW PART NO.
A0-21652-2	060-021652	A0-24692-62	003-034239
A0-21709	060-021709	A0-24692-63	003-034240
A0-21732-0	060-021732	A0-24692-64	003-034241
A0-21750-2	123-000010	A0-24692-65	003-034242
A0-21751	060-021751	A0-24692-66	003-034243
A0-21880-12	121-000060	A0-24692-67	003-034244
A0-21880-9	121-000057	A0-24692-68	003-034245
A0-21895-1	120-000008	A0-24692-69	003-034246
A0-21901-0	008-021901	A0-24692-70	003-034247
A0-21930-3	125-000023	A0-24692-71	003-034248
A0-21986-0	450-030100	A0-24692-72	003-034249
A0-22001-0	450-040200	A0-24692-73	003-034250
A0-22020	003-022020	A0-24692-74	003-034251
A0-22061-1	003-036229	A0-24692-75	003-034252
A0-22065-5	112-000013	A0-24692-76	003-034253
A0-22065-8	112-000016	A0-24692-77	003-034254
A0-22566-10	602-050042	A0-24692-78	003-034255
A0-22566-22	602-050072	A0-24692-79	003-034256
A0-22753-0	450-040201	A0-24692-80	003-034257
A0-23270-1	121-000085	A0-24692-81	003-034258
A0-23322-2	057-023322	A0-24692-82	003-034259
A0-23421-0	014-023421	A0-24692-83	003-034260
A0-2344-10	021-035140	A0-24692-84	003-034261
A0-2344-6	021-035137	A0-24692-85	003-034262
A0-23497-0	450-040302	A0-24692-86	003-034263
A0-23516-1	011-036408	A0-24692-87	003-034264
A0-23539-1	016-036411	A0-24692-88	003-034265
A0-24112-0	003-024112	A0-24692-89	003-034266
A0-24113-1	003-036499	A0-24692-90	003-034267
A0-24692-44	003-036683	A0-24692-91	003-034268
A0-24692-45	003-036684	A0-24891-1	003-024891
A0-24692-46	003-036685	A0-24891-2	003-036753
A0-24692-47	003-036687	A0-24895	003-024895
A0-24692-48	003-036689	A0-25319-0	003-036864
A0-24692-49	003-034226	A0-25327-0	003-025327
A0-24692-50	003-034227	A0-25417-1	003-025417
A0-24692-51	003-034228	A0-25581-0	015-025581
A0-24692-52	003-034229	A0-26387-1	450-040082
A0-24692-53	003-034230	A0-28-1	117-000005
A0-24692-54	003-034231	A0-28-2	117-000006
A0-24692-55	003-034232	A0-32-1	127-000013
A0-24692-56	003-034233	A0-32135-1	031-034331
A0-24692-57	003-034234	A0-32135-10	031-034340
A0-24692-58	003-034235	A0-32135-11	031-034341
A0-24692-59	003-034236	A0-32135-12	031-034342
A0-24692-60	003-034237	A0-32135-13	031-034343
A0-24692-61	003-034238	A0-32135-3	031-034333

CROSS REFERENCE INDEX (CONT)
HAMMOND PART NUMBERS, OLD TO NEW

OLD PART NO.	NEW PART NO.	OLD PART NO.	NEW PART NO.
A0-32135-4	031-034334	A0-605-84	425-010121
A0-32135-7	031-034337	A0-605-87	425-010151
A0-32135-8	031-034338	A0-605-90	425-010181
A0-32135-9	031-034339	P0-15772-1	032-015772
A0-33-3	126-000010	P0-16265-0	020-016265
A0-501-169	401-020773	P0-16268-001	032-016268
A0-501-19	401-020533	P0-16278-0	016-035704
A0-501-49	401-020262	P0-1698-0	025-001698
A0-501-67	401-020652	P0-1701-0	042-001701
A0-503-17	403-030453	P0-1720-0	042-001720
A0-503-22	403-030653	P0-1721-0	042-001721
A0-503-57	403-030452	P0-1749-4	999-001413
A0-503-65	403-030612	P0-1911-0	042-001911
A0-505-10	420-010113	P0-1912-0	042-001912
A0-506-006	406-010072	P0-1914-0	042-001914
A0-506-022	406-010232	P0-20172-0	041-032935
A0-506-024	406-010252	P0-2031	012-035585
A0-506-13	406-010142	P0-20555-4	032-020555
A0-506-3	406-010042	P0-20658-0	012-020658
A0-507-0	407-080017	P0-2071-1	025-002071
A0-507-1	407-010029	P0-21391-1	025-036036
A0-513-13	413-010142	P0-21391-2	025-036037
A0-513-3	413-010042	P0-21391-3	025-036038
A0-605-030	425-010463	P0-21688-0	012-033227
A0-605-048	425-010232	P0-21728-0	043-031436
A0-605-060	425-010482	P0-21865-0	012-021865
A0-605-080	425-010081	P0-21914-1	025-036081
A0-605-13	425-010500	P0-21914-2	025-036082
A0-605-145	425-010746	P0-21914-3	025-036083
A0-605-146	425-010752	P0-21914-4	025-036084
A0-605-153	425-010763	P0-22369-0	042-022369
A0-605-25	425-010253	P0-22384-0	042-022384
A0-605-26	425-010293	P0-22385-0	042-022385
A0-605-27	425-010333	P0-22885-0	016-022885
A0-605-300	425-030583	P0-22931-1	025-036295
A0-605-31	425-010503	P0-23309-0	025-023309
A0-605-33	425-010583	P0-23310-0	025-023310
A0-605-34	425-010623	P0-2345-0	012-002345
A0-605-35	425-010663	P0-23546-0	061-023546
A0-605-49	425-010252	P0-23547-0	061-023547
A0-605-51	425-010292	P0-23557-1	031-023557
A0-605-56	425-010392	P0-23988-2	016-031453
A0-605-57	425-010412	P0-2619-2	025-002619
A0-605-62	425-010522	P0-2638-A	025-035671
A0-605-63	425-010542	P0-2638-B	025-035672
A0-605-65	425-010582	P0-2638-C	025-035666
A0-605-69	425-010662	P0-2638-CX	025-035673
A0-605-82	425-010101		

CROSS REFERENCE INDEX (CONT)
HAMMOND PART NUMBERS, OLD TO NEW

OLD PART NO.	NEW PART NO.	OLD PART NO.	NEW PART NO.
P0-2638-D	025-035667		
P0-2638-E	025-035668		
P0-2638-F	025-035669		
P0-2638-G	025-035670		
P0-2639-A	025-035681		
P0-2639-B	025-035682		
P0-2639-C	025-035676		
P0-2639-D	025-035677		
P0-2639-E	025-035678		
P0-2639-F	025-035679		
P0-2639-G	025-035680		
S-10514-4	824-000003		

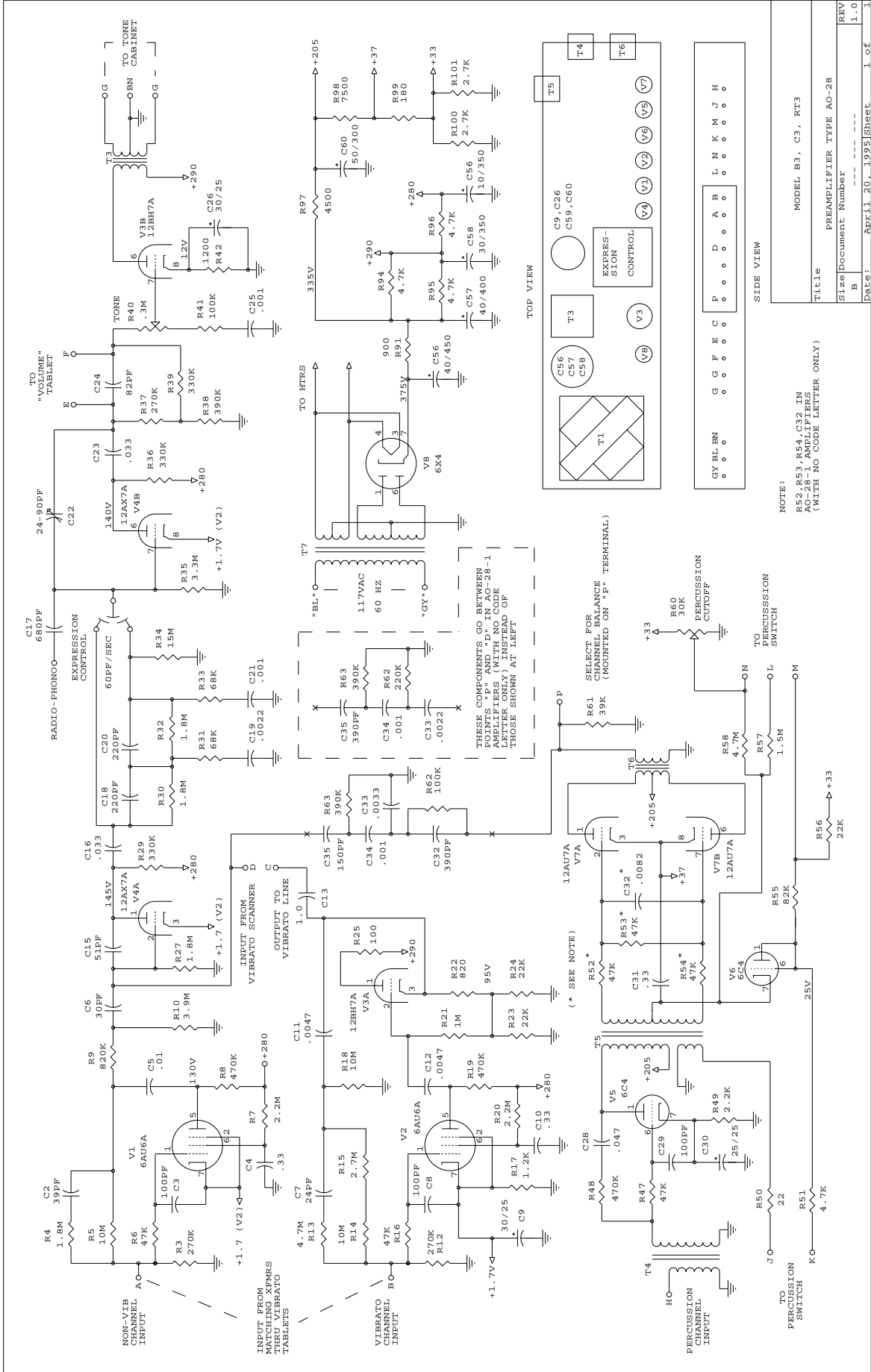

NOTE:
 R52, R53, R54, C32 IN
 AO-28-1 AMPLIFIERS
 (WITH NO CODE LETTER ONLY)

MODEL B3, C3, RT3

Title	
A	PREAMPLIFIER TYPE AO-28
B	Size Document Number
REV	1.0

Date: April 20, 1955 Sheet 1 of 1

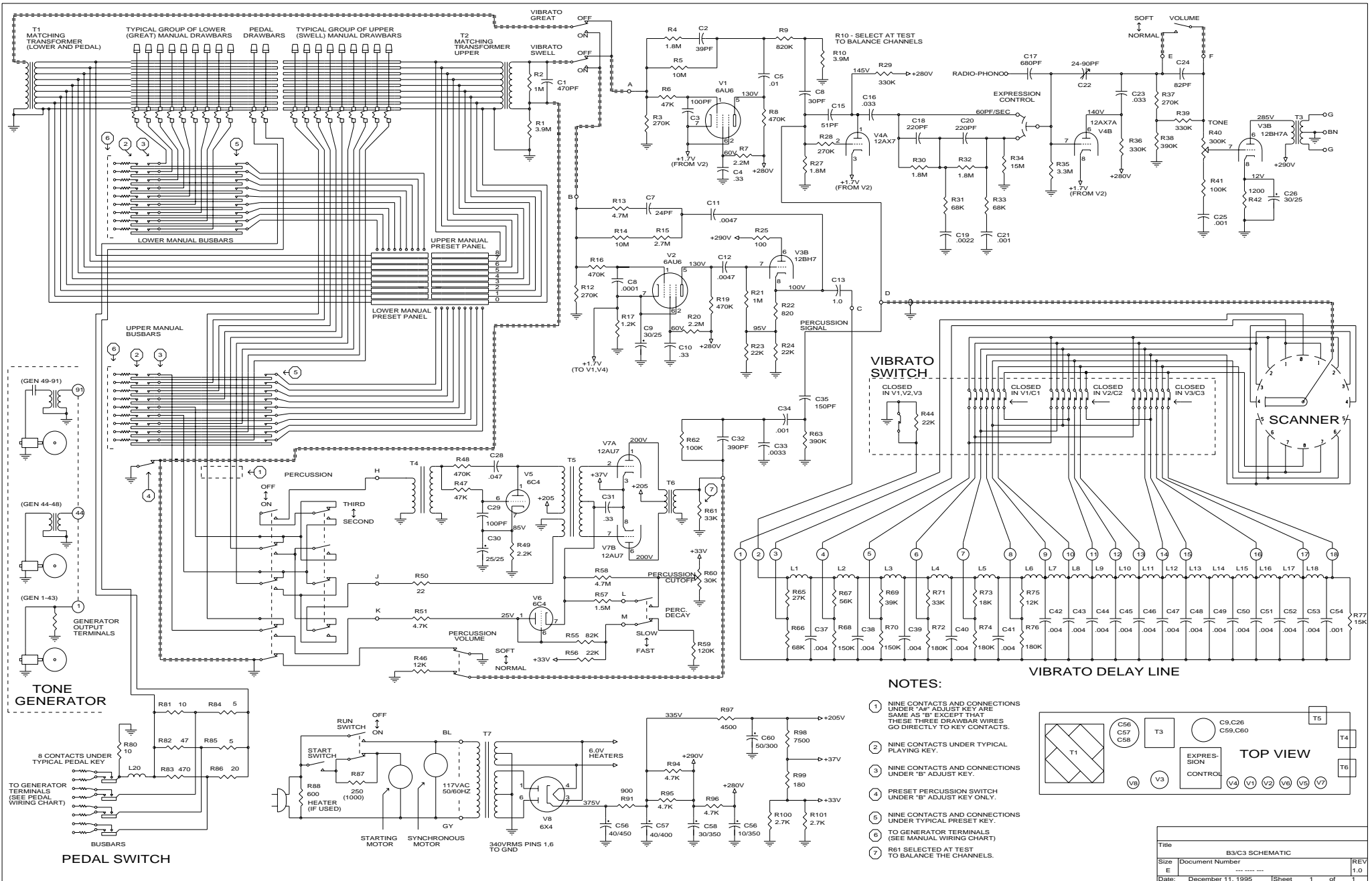

NOTES:

- 1 NINE CONTACTS AND CONNECTIONS UNDER "A" ADJUST KEY ARE SAME AS "B" EXCEPT THAT THESE THREE DRAWBAR WIRES GO DIRECTLY TO KEY CONTACTS.
- 2 NINE CONTACTS UNDER TYPICAL PLAYING KEY.
- 3 NINE CONTACTS AND CONNECTIONS UNDER "B" ADJUST KEY.
- 4 PRESET PERCUSSION SWITCH UNDER "B" ADJUST KEY ONLY.
- 5 NINE CONTACTS AND CONNECTIONS UNDER TYPICAL PRESET KEY.
- 6 TO GENERATOR TERMINALS (SEE MANUAL WIRING CHART)
- 7 R61 SELECTED AT TEST TO BALANCE THE CHANNELS.

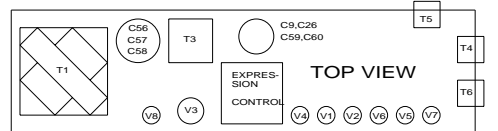

Title			B3/C3 SCHEMATIC
Size	Document Number	REV	
E	-----	1.0	
Date:	December 11, 1995	Sheet	1 of 1

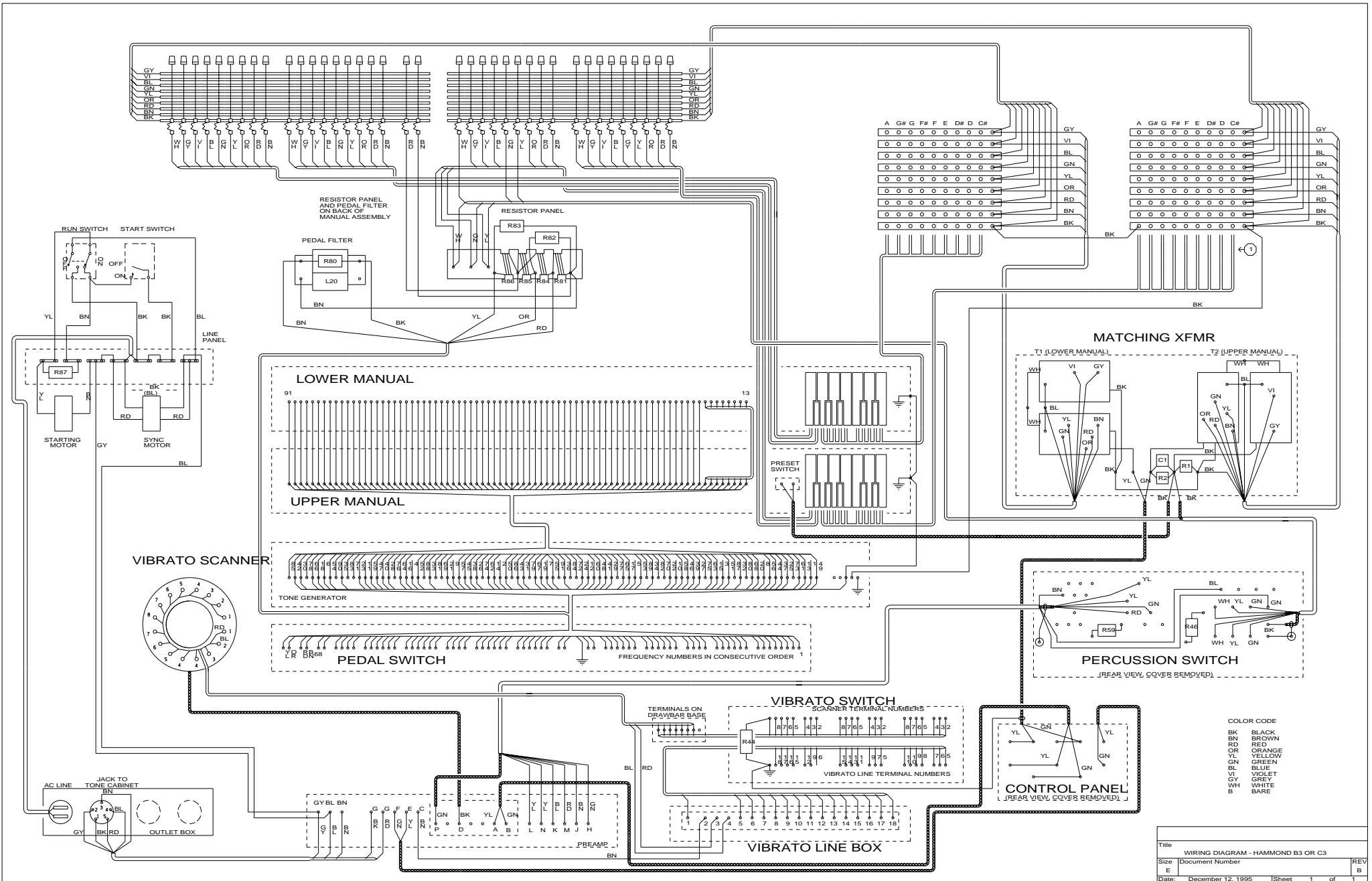

COLOR CODE
 BK BLACK
 BN BROWN
 RD RED
 OR ORANGE
 GN GREEN
 BL BLUE
 VI VIOLET
 GY GREY
 WH WHITE
 B BARE

Title	WIRING DIAGRAM - HAMMOND B3 OR C3	
Size	Document Number	
E		REV
Date:	December 12, 1995	Sheet 1 of 1