

XE20



SPECIFICATIONS

ACOUSTIC & ELECTRICAL SPECIFICATIONS:

- * Nominal Impedance: 8 ohm
- * Recommended Amp Power: 10-100W
- * Frequency Response: 65 Hz - 20 kHz (-6dB)
- * Sensitivity: 88 dB / 2,83V / 1 m
- * Crossover frequency: 4 kHz

SYSTEM COMPONENTS:

- * Cabinet: CXE20 (Not for sale)
- * Grille: GXE20 (2404140)
- * Woofer: A0906A 170mm Woofer
Polymer laminate cone

SYSTEM COMPONENTS: (cont'd)

- * Tweeter: TW010MR 10mm
Titanium Dome Tweeter
- * Crossover Network: NXE20 (2707740)

PHYSICAL SPECIFICATIONS:

- * Enclosure Dimensions (H.W.D): 13,8x7,8x9,6 In. D
(350x200x245mm D)
- * Shipping Weight: 10,5 lbs. (4,8 kg.)

WARRANTY INFORMATION:

- * Refer to the Warranty Statement packed with each product

PACKAGE

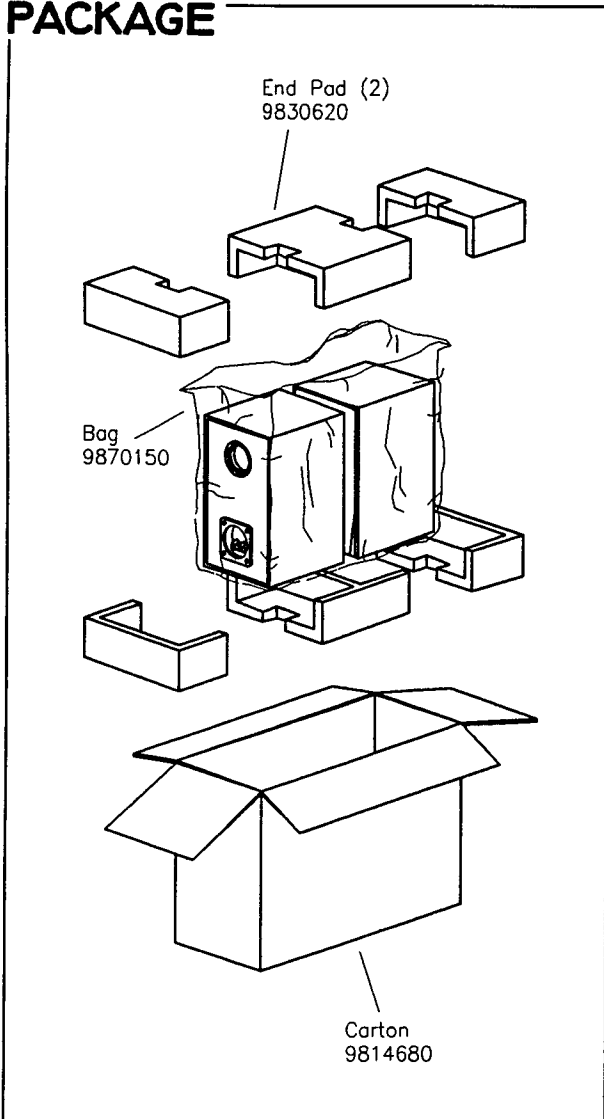

WIRING DIAGRAM

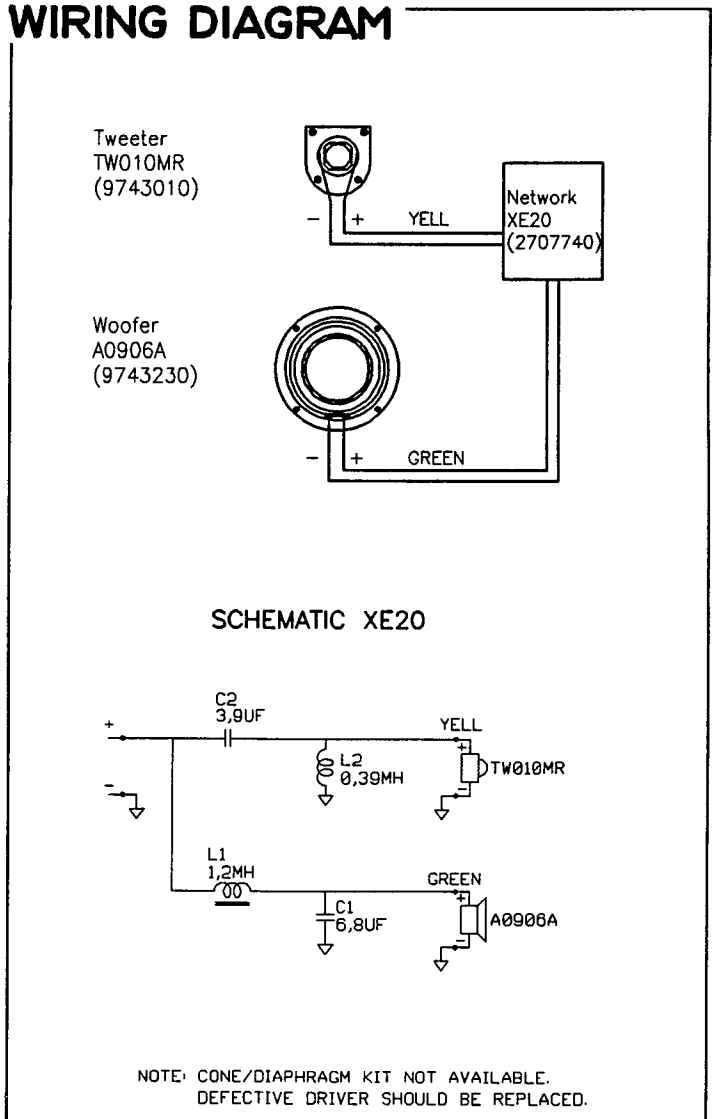

XE20

Valid from serial no. 03101
Rev 19/12-1995

COMPONENT EXPLODED VIEW

