

Ersatzteilliste • Spare Parts List • Liste de rechanges • Lista de requestos

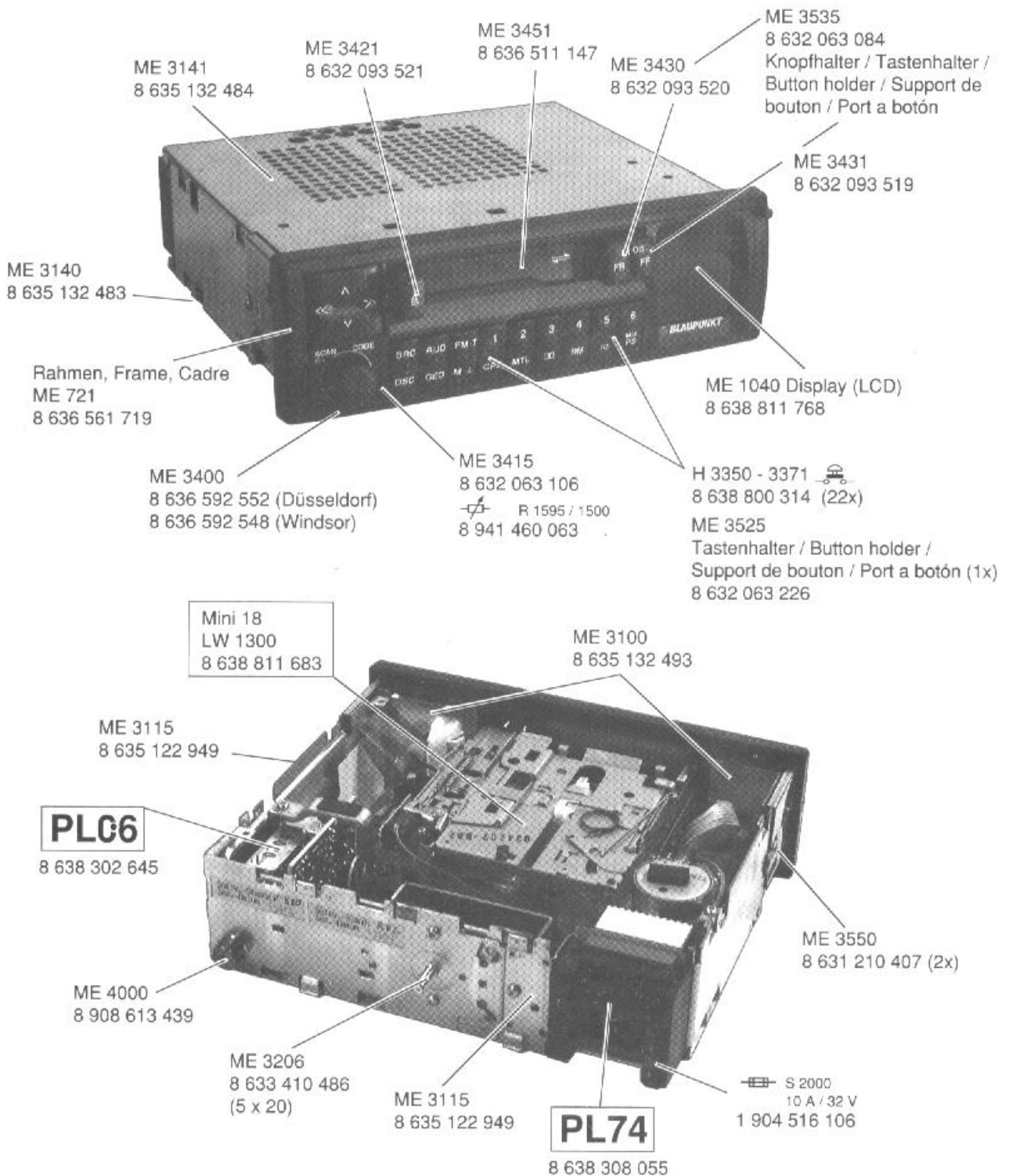

Wichtige mechan. Bauteile
Composants mécaniques importants

Important mechanical parts
Componentes mecánicas importantes



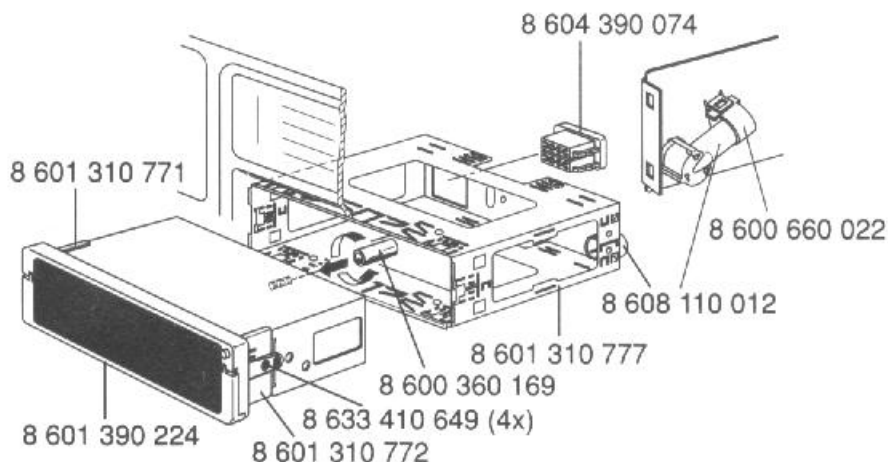

	(D)	(GB)	(F)	(E)	
LW 1300	Cassettenlaufwerk	Cass. drive mecan	Mecanisme de Cass.	Mecanismo Cas.	8 638 811 683
ME 109	Schraube M3x6	Screw	Vis	Tornillo	8 633 410 992
ME 110	Schraube M2,5x6	Screw	Vis	Tornillo	8 633 410 630
ME 111	Schraube M2,5x6	Screw	Vis	Tornillo	8 633 410 572
ME 112	Schraube M4x8	Screw	Vis	Tornillo	8 633 410 649
ME 113	Schraube M2,5x8	Screw	Vis	Tornillo	8 633 410 573
ME 119	Druckfeder	Spring	Ressort	Muelle	8 634-630 187
ME 120	Reflektor (LCD)	Reflector (Display)	Reflecteur	Reflector	8 635 310 248
ME 501	Drehfeder	Torsion spring	Ressort de torsion	Muelle de torsion	8 634 650 140
ME 604	Kontaktplatte PL74	Contact plate PL74	Plaque de contact PL74	Placa de contacto PL74	8 638 302 988
ME 608	UKW-Tunerplatte	Tuner FM	Platine Tuner VHF	Placa sintonia OUC	8 638 302 645
ME 613	Steckkontakt (29 polig)	Plug in cont. (N 1001)	Fiche male	Cont. de Echufa	8 634 391 812
ME 721	Halterahmen (ME 3400)	Frame	Cadre support	Marco de fijación	8 636 561 719
ME 722	Rastfeder (2x)	Stop spring	Ressort d'arrêt	Muelle de retención	8 631 210 407
ME 803	Leitungsverbinder	Cable joint	Raccord des câbles	Empalme de cable	8 600 660 006
ME 811	Halterahmen (50 mm)	Frame	Cadre support	Marco de fijación	8 601 310 742
ME 812	Teilesatz	Parts set	Jeu de pièces	Juego de piezas	8 607 010 438
ME 813	Antennenstecker	Antenna plug	Fiche d'antenne	Clacija de antena	8 908 603 224
ME 814	Buchsenhalter	Jack holder	Support de borne	Soporte de bornes	8 600 660 019
ME 815	Anschlußblock +/-	Connecting block	Bloc d'assemblage	Bloque de acoplamiento	8 604 390 078
ME 816	Anschlußblock Lautsprecher	Connect. block speaker	Bloc d'assemblage H-P	Bloque de acoplamiento	8 604 390 050
ME 901	Demontagebügel	Dismantling aid	Etrier de démontage	Estribo de desmontaje	8 601 910 002
ME 903	Distanzbolzen (2x)	Spacer pin (2x)	Axe entretoise	Perno distanciador	8 603 160 008
ME 904	Führungsbolzen	Guide pin	Tige de guidage	Perno de guía	8 600 460 050
ME 1001	Knopfhalter (ME 3415)	Button holder	Support de bouton	Port a botón (ME 3415)	8 631 212 023
ME 1002	Torx-Schraube M3x5,8	Screw	Vis	Tornillo	8 633 410 751
ME 1007	Knopfhalter (FR-FF)	Button holder	Support de bouton	Port a botón	8 632 063 084



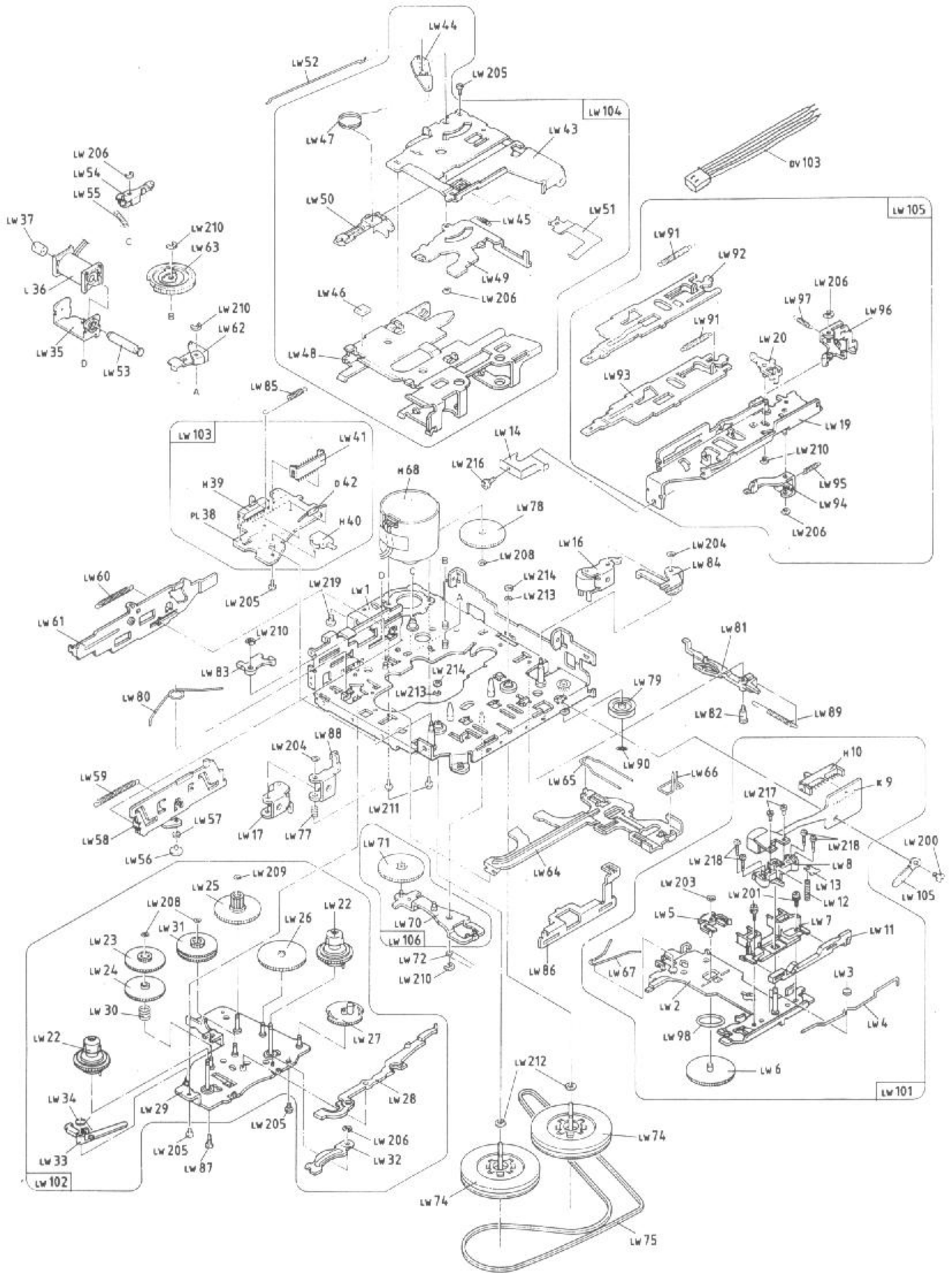



Position Position Position Posición	Bestell-Nr. Part no. No. de commande Número de pedido
LW 2	8 628 800 428
LW 3	8 626 600 475
LW 4	8 621 200 115
LW 5	8 621 901 689
LW 6	8 626 300 442
LW 7	8 621 901 690
LW 8	8 621 300 145
LW 11	8 621 901 691
LW 12	8 621 200 116
LW 13	8 620 105 426
LW 14	8 621 901 719
LW 16	8 621 901 692
LW 17	8 621 901 693
LW 19	8 621 901 694
LW 20	8 621 901 686
LW 22	8 626 600 469
LW 23	8 626 600 470
LW 24	8 626 600 471
LW 25	8 626 600 472
LW 26	8 626 600 473
LW 27	8 626 300 443
LW 28	8 621 901 721
LW 29	8 621 300 146
LW 30	8 621 200 117
LW 31	8 626 600 476
LW 32	8 621 901 695
LW 33	8 621 901 688
LW 34	8 621 200 118
LW 35	8 621 300 155
LW 37	8 623 100 407
LW 41	8 622 002 000
LW 43	8 621 300 147
LW 44	8 621 901 580
LW 45	8 624 600 675
LW 46	8 622 306 053
LW 47	8 621 200 119
LW 48	8 625 100 086
LW 49	8 621 300 149
LW 50	8 621 901 696
LW 51	8 621 200 120
LW 52	8 624 600 673
LW 53	8 623 100 406
LW 54	8 621 901 707
LW 55	8 624 600 861
LW 56	8 626 600 477
LW 57	8 626 600 478
LW 58	8 621 300 150
LW 59	8 621 200 121
LW 60	8 621 200 122
LW 61	8 621 901 697
LW 62	8 621 901 706
LW 63	8 626 600 479
LW 64	8 621 300 151
LW 65	8 621 200 123
LW 66	8 621 200 124
LW 67	8 624 600 862
LW 70	8 621 300 154
LW 71	8 626 600 461

Position Position Position Posición	Bestell-Nr. Part no. No. de commande Número de pedido
LW 72	8 621 200 125
LW 74	8 620 100 548
LW 75	8 624 700 416
LW 77	8 624 600 800
LW 78	8 626 600 463
LW 79	8 626 600 464
LW 80	8 624 600 860
LW 81	8 621 901 704
LW 82	8 623 400 199
LW 83	8 621 901 705
LW 84	8 621 901 702
LW 85	8 621 200 127
LW 86	8 621 901 701
LW 87	8 623 400 210
LW 88	8 621 901 700
LW 89	8 621 200 128
LW 90	8 620 105 427
LW 91	8 621 200 129
LW 92	8 621 901 698
LW 93	8 621 901 699
LW 94	8 621 300 152
LW 95	8 621 200 130
LW 96	8 621 300 153
LW 97	8 621 200 131
LW 98	8 620 105 438
LW 101	8 628 800 429
LW 102	8 628 800 420
LW 103	8 622 002 103
LW 104	8 628 800 422
LW 105	8 628 800 423
LW 106	8 621 901 722
LW 200	9 623 400 227
LW 201	8 623 400 211
LW 203	8 620 105 429
LW 204	8 620 105 430
LW 205	8 623 400 216
LW 206	8 620 105 436
LW 207	8 623 400 232
LW 208	8 620 105 431
LW 209	8 620 105 432
LW 210	8 620 105 437
LW 211	8 623 400 215
LW 212	8 620 105 433
LW 213	8 620 105 434
LW 214	8 620 105 435
LW 217	8 623 400 213
LW 218	8 623 400 214
LW 219	8 623 400 217
DV 103	8 624 400 253
K 9	8 627 609 509
H 10	8 908 003 512
L 36	8 624 200 607
PL 38	8 628 309 769
H 39	8 908 003 513
H 40	8 908 003 514
D 42	8 905 405 342
M 68	8 627 205 766



Position Position Position Posición	Bezeichnung Designation Dénomination Denominación	Bestell-Nr. Part no. No. de commande Número de pedido
		
B 1001	14 V 100 mA GELB	1 907 598 275
B 1002	14 V 100 mA GRÜN	8 928 410 035
		
D 50	Z 47	8 925 421 048
D 51	Z 47	8 925 421 048
D 340	BAL99	8 925 405 137
D 630	BAV99	8 925 405 124
D 635	BB512	8 925 405 159
D 650	BB512	8 925 405 159
D 720	BAL99	8 925 405 137
D 721	BZX84B10	8 925 421 068
D 860	BZX84C5V1	8 925 421 062
D 867	BAL99	8 925 405 137
D 1006	BAV99L	8 925 405 124
D 1040	BZX84C9V1	8 925 421 034
D 1200	RLR 4001	8 925 800 044
D 1590	BAV99L	8 925 405 124
D 1680	BAW56L	8 925 405 015
D 2000	S3G	8 925 405 023
D 2010	1N4148	8 925 405 822
D 2020	BAX14	8 925 405 069
D 2050	BZX84B9V1	8 925 421 065
D 2090	1N4148	8 925 405 822
D 2091	BZX84C5V1	8 925 421 062
D 2430	BAL99	8 925 405 137
D 5350	BAV70	8 925 405 122
D 5351	BAW56L	8 925 405 015
		
F 152	10,7 MHz	8 948 417 025
F 635	800 kHz	8 948 415 044
F 636	250 kHz	8 948 412 068
F 660	455 kHz	8 948 413 008
		
L 5		8 928 411 137
L 50		8 928 411 137
L 182		8 928 411 043
L 650		8 948 415 059
L 651		8 948 415 048
L 700		8 928 411 035
L 701		8 928 411 045
L 2000		8 948 411 065
L 2004		8 948 411 056
L 2007		8 928 411 038
L 2080		8 928 411 035
L 2400		8 928 411 035
		
Q 155	10,7 MHz	8 926 193 200
Q 310	456 kHz	8 946 193 307
Q 660	460 kHz	8 946 193 248
Q 850		8 926 193 002
Q 851	32,768 kHz	8 946 193 233
Q 2450		8 926 193 001

Position Position Position Posición	Bezeichnung Designation Dénomination Denominación	Bestell-Nr. Part no. No. de commande Número de pedido
 		
R 191	10 kΩ	8 921 500 002
R 1023	NTC	8 951 300 003
R 1250	2,2 kΩ	8 921 500 009
R 1260	2,2 kΩ	8 921 500 009
 		
V 152	TDA 4220-X	8 925 900 988
V 310	TDA 1591	8 925 900 977
V 311	BC 848 B	8 925 705 043
V 340	BC 848 B	8 925 705 043
V 360	BC 848 B	8 925 705 043
V 600	BF 545C	8 925 705 185
V 620	BF 543	8 925 705 184
V 625	BC 848C	8 925 705 037
V 636	BC 848C	8 925 705 139
V 638	BC 848C	8 925 705 037
V 650	BC 848C	8 925 705 139
V 655	BC 848C	8 925 705 139
V 659	BC 848C	8 925 705 037
V 660	TDA 1072A	8 925 900 247
V 700	SDA 4330	8 925 901 029
V 720	BC 848 B	8 925 705 043
V 741	BC 848 C	8 925 705 037
V 850	TMP47C860F	8 925 901 402
V 851	BC 858 C	8 925 705 039
V 870	BC 848 B	8 925 705 043
V 1000	UPD 7229AGF	8 925 900 312
V 1001	BC 818-40	8 925 705 228
V 1002	BC 818-40	8 925 705 228
V 1010	MC 33072	8 925 900 319
V 1040	BC 848 B	8 925 705 043
V 1150	TA 7705F	8 925 900 012
V 1200	BC 875	8 925 707 201
V 1205	BA 4558F	8 925 900 308
V 1250	HA 12135	8 925 900 229
V 1301	BC 369	8 925 705 304
V 1302	BC 848 B	8 925 705 043
V 1500	TDA 4390	8 925 900 920
V 1570	LM 837 M	8 925 900 205
V 1580	BC 818-25	8 925 705 041
V 1581	BC 818-25	8 925 705 041
V 1582	BC 818-25	8 925 705 041
V 1583	BC 818-25	8 925 705 041
V 1590	BC 858B	8 925 705 038
V 1650	TDA 7374V	8 945 903 239
V 1660	TDA 7374V	8 945 903 239
V 2020	L4949ND	8 925 900 348
V 2040	BC 848 C	8 925 705 037
V 2041	DTA143ZKTD	8 925 705 233
V 2042	DTC143ZKTD	8 925 705 234
V 2043	DTC143ZKTD	8 925 705 234
V 2045	BC 848 B	8 925 705 043
V 2050	BC 337-25	8 925 707 347
V 2060	BC 337-25	8 925 707 347
V 2065	BC 858 C	8 925 705 039
V 2080	BC808-25	8 925 705 042
V 2085	BC808-25	8 925 705 042
V 2090	BC 337-25	8 925 707 347
V 2400	TMS375C006	8 925 901 522
V 2402	BC 848 B	8 925 705 043
V 2430	BC808-25	8 925 705 042

Position Position Position Posición	Bezeichnung Designation Dénomination Denominación	Bestell-Nr. Part no. No. de commande Número de pedido
V 2431	DTC 144	8 925 705 198
V 2432	BC808-25	8 925 705 042
V 2470	BC 848 B	8 925 705 043
V 2472	BC 858 B	8 925 705 038
V 2475	BC 858 B	8 925 705 038
V 2477	BC 848 B	8 925 705 043
V 2480	BFR 30	8 925 705 131
V 2500	TDA 7332	8 925 900 477

Position Position Position Posición	Bezeichnung Designation Dénomination Denominación	Bestell-Nr. Part no. No. de commande Número de pedido

Hinweis:
Handelsübliche Kondensatoren und Widerstände sind in der Ersatzteilliste nicht aufgeführt. Wir bitten Sie, diese Teile im Fachhandel zu beziehen.

Nota:
Des condensateurs et résistances commerciaux ne sont pas inclus dans la liste des pièces détachées. Veuillez acheter ces pièces chez votre spécialiste.

Note:
Capacitors and resistors usual in trade are not mentioned in the spare parts list. Kindly buy these parts from the specialized trade.

Nota:
No se indican en la lista de piezas de requestos los condensadores y los resistores de uso comercial. Les rogamos comprar esas piezas en el comercio especializado.

Blaupunkt-Werke GmbH, Hildesheim

Änderungen vorbehalten! Nachdruck - auch auszugsweise - nur mit Quellenangabe gestattet!

Modification réservées! Reproduction - aussi en abrégé - permise seulement avec indication des sources utilisées

Gedruckt in Deutschland
Printed in Germany by HDR

Modification reserved! Reproduction - also by extract - only permitted with indication of sources used

¡Modificaciones reservadas! Reproducción - también en parte solamente permitida con indicación de las fuentes utilizadas