

Ersatzteilliste • Spare Parts List • Liste de rechanges • Lista de requestos

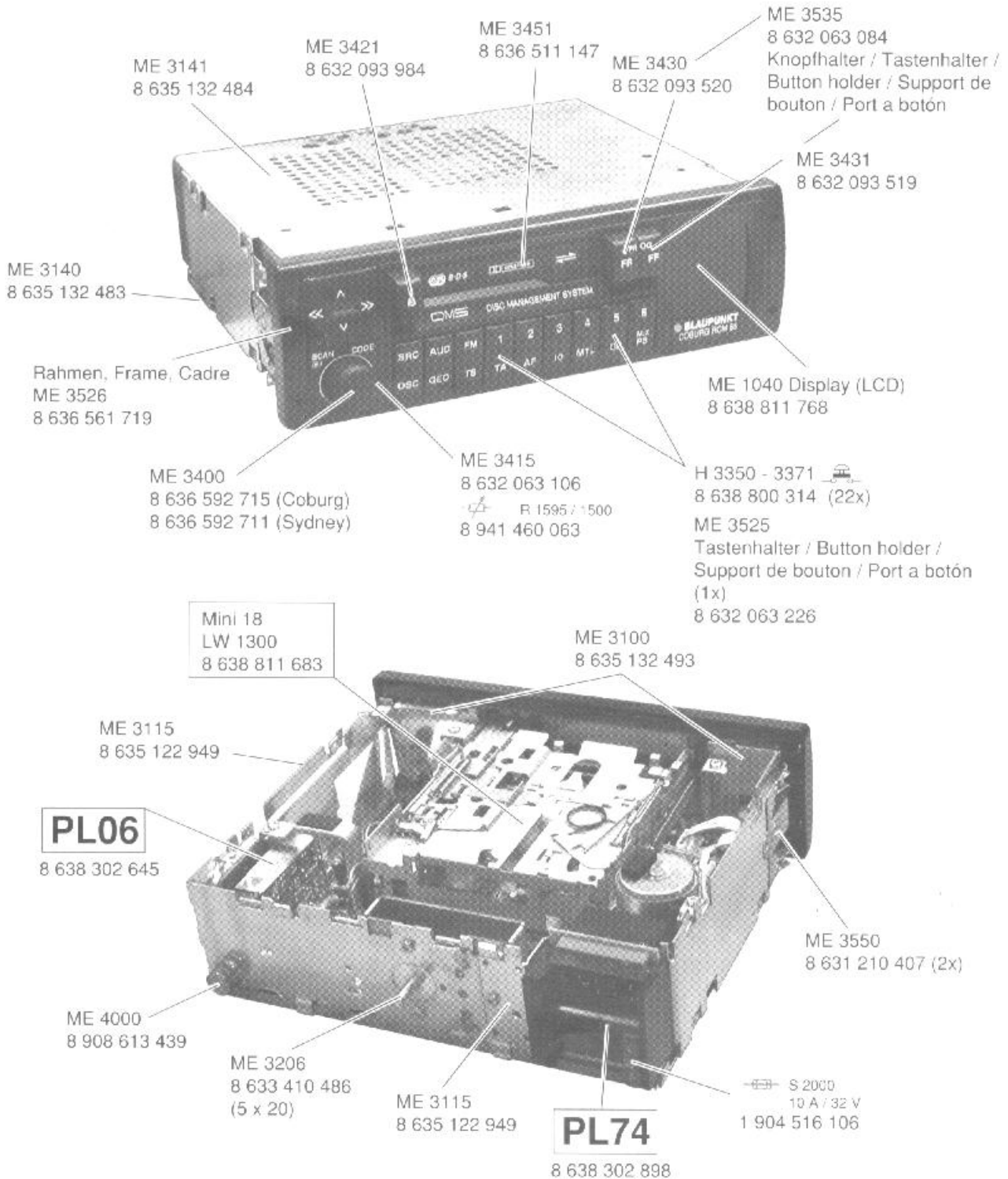

Wichtige mechan. Bauteile
Composants mécaniques importants

Important mechanical parts
Componentes mecánicas importantes

	(D)	(GB)	(F)	(E)	
ME 3200	SCHRAUBE/M2,5X6	SCREW	VIS	TORNILLO	8 633 410 572
ME 3201	SCHRAUBE/M2,5X6	SCREW	VIS	TORNILLO	8 633 410 572
ME 3202	SCHRAUBE/M2,5X6	SCREW	VIS	TORNILLO	8 633 410 630
ME 3203	SCHRAUBE/M2,5X6	SCREW	VIS	TORNILLO	8 633 410 572
ME 3204	SCHRAUBE/M4X8	SCREW	VIS	TORNILLO	8 633 410 649
ME 3215	SCHRAUBE/M2,5X8	SCREW	VIS	TORNILLO	8 633 410 573
ME 3450	DRUCKFEDER (EJECT)	PRESSURE SPRING	RESSORT PRESSION	MUELLE DE COMPRESI	8 634 630 187
ME 3990	HALTERAHMEN	FRAME	CADRE SUPPORT	MARCO DE FIJACION	8 601 310 742
ME 3992	TEILESATZ	PARTS SET	JEU DE PIECES	JUEGO DE PIEZAS	8 607 010 438
ME 3994	BUCHSENHALTER	JACK HOLDER	SUPPORT DE BORNE	SOPORTE DE BORNES	8 600 660 019
ME 4400	ANSCHLUSSBLOCK	CONNECTING BLOCK	BLOC D'ASSEMBLAGE	BLOQ D ACOPLAMIENT	8 604 390 078
ME 4401	ANSCHLUSSBLOCK/ MIT LA-BUCHSE	CONNECTING BLOCK	BLOC D'ASSEMBLAGE	BLOQ D ACOPLAMIENT	8 604 390 050
ME 3280	DEMONTAGEBÜGEL	DISMANTLING AID	ETRIER DE DEMONT.	ESTRIBO DE DESMONT	8 601 910 002
ME 3980	DISTANZBOLZEN	SPACER PIN	AXE ENTRETOISE	PERNO DISTANCIADOR	8 603 160 008
ME 3982	FÜHRUNGSBOLZEN	GUIDE PIN	TIGE DE GUIDAGE	PERNO DE GUIA	8 600 460 050
ME 3220	KNOPFHALTER (FF/FR)	BUTTON HOLDER	SUPPORT DE BOUTON	PORTABOTON	8 631 212 023
ME 3207	DREHFEDER (CASS.-KL)	TORSION SPRING	RESSORT DE TORSION	MUELLE DE TORSION	8 634 650 140
ME 3423	TASTWIPPE/(2-FACH)	ROCKER-SWITCH	INVERS. DE TOUCHE	BASCULA PALPADORA	8 632 093 500
ME 3425	TASTWIPPE/(4-FACH)	ROCKER-SWITCH	INVERS. DE TOUCHE	BASCULA PALPADORA	8 632 093 502
ME 3530	LED-HALTER	LED HOLDER	SUPPORT DE LED	SUJETADOR LED	8 632 360 694
ME 3216	SCHRAUBE/M3X6	SCREW	VIS	TORNILLO	8 633 410 592
ME 3858	STECKKONTAKT/29-POL.	PLUGIN CONTACT	FICHE MALE	CONT.DE ENCHUFABLE	8 634 391 812
ME 3470	REFLEKTOR	REFLECTOR	REFLECTEUR	REFLECTOR	8 635 310 248
ME 3210	TORX-SCHRAUBE/M3X5,8	OVAL-HEAD SCREW	VIS SUIF AUTOSERR.	TORN.ALOMADO TORX	8 633 410 751



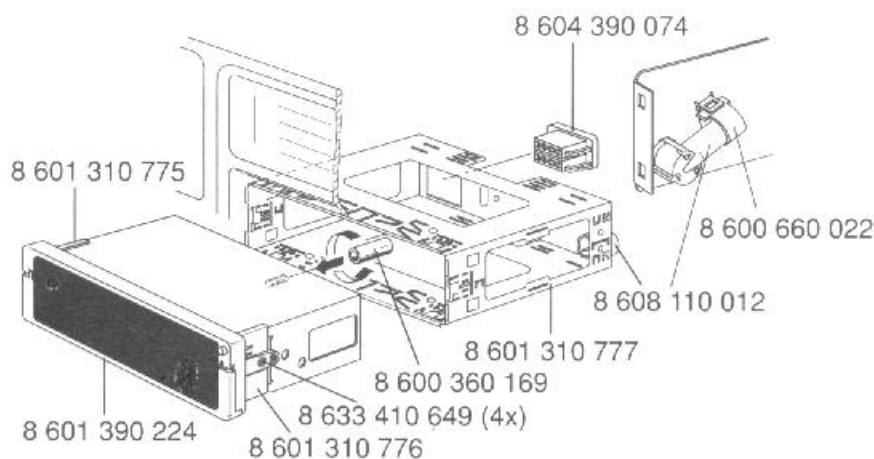

Sydney RCM 85

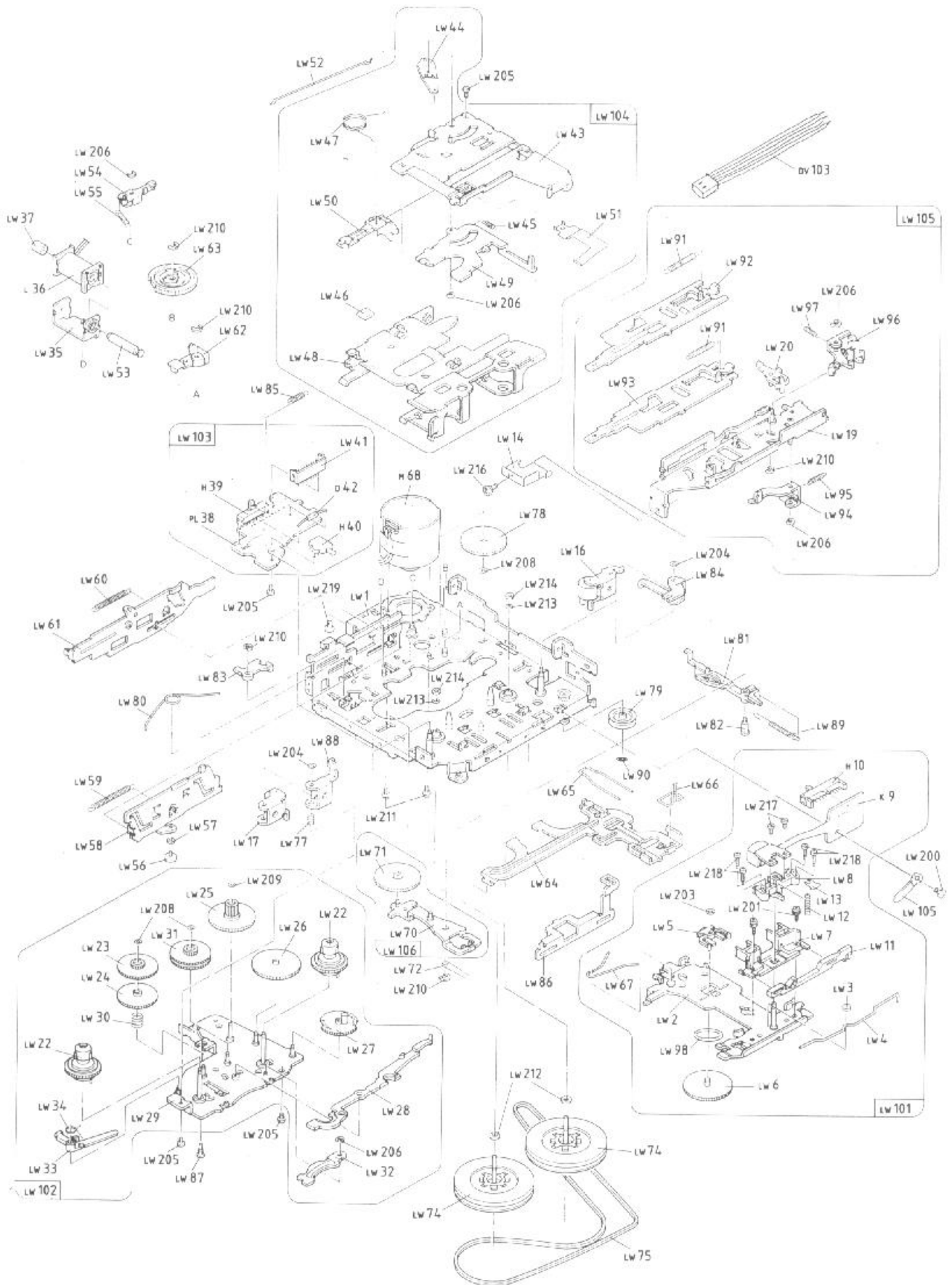

Position Position Position Posición	Bestell-Nr. Part no. No. de commande Número de pedido
LW 2	8 628 800 428
LW 3	8 626 600 475
LW 4	8 621 200 115
LW 5	8 621 901 689
LW 6	8 626 300 442
LW 7	8 621 901 690
LW 8	8 621 300 145
LW 11	8 621 901 691
LW 12	8 621 200 116
LW 13	8 620 105 426
LW 14	8 621 901 719
LW 16	8 621 901 692
LW 17	8 621 901 693
LW 19	8 621 901 694
LW 20	8 621 901 686
LW 22	8 626 600 469
LW 23	8 626 600 470
LW 24	8 626 600 471
LW 25	8 626 600 472
LW 26	8 626 600 473
LW 27	8 626 300 443
LW 28	8 621 901 721
LW 29	8 621 300 146
LW 30	8 621 200 117
LW 31	8 626 600 476
LW 32	8 621 901 695
LW 33	8 621 901 688
LW 34	8 621 200 118
LW 35	8 621 300 155
LW 37	8 623 100 407
LW 41	8 622 002 000
LW 43	8 621 300 147
LW 44	8 621 901 580
LW 45	8 624 600 675
LW 46	8 622 306 053
LW 47	8 621 200 119
LW 48	8 625 100 086
LW 49	8 621 300 149
LW 50	8 621 901 696
LW 51	8 621 200 120
LW 52	8 624 600 673
LW 53	8 623 100 406
LW 54	8 621 901 707
LW 55	8 624 600 861
LW 56	8 626 600 477
LW 57	8 626 600 478
LW 58	8 621 300 150
LW 59	8 621 200 121
LW 60	8 621 200 122
LW 61	8 621 901 697
LW 62	8 621 901 706
LW 63	8 626 600 479
LW 64	8 621 300 151
LW 65	8 621 200 123
LW 66	8 621 200 124
LW 67	8 624 600 862
LW 70	8 621 300 154
LW 71	8 626 600 461

Position Position Position Posición	Bestell-Nr. Part no. No. de commande Número de pedido
LW 72	8 621 200 125
LW 74	8 620 100 548
LW 75	8 624 700 416
LW 77	8 624 600 800
LW 78	8 626 600 463
LW 79	8 626 600 464
LW 80	8 624 600 860
LW 81	8 621 901 704
LW 82	8 623 400 199
LW 83	8 621 901 705
LW 84	8 621 901 702
LW 85	8 621 200 127
LW 86	8 621 901 701
LW 87	8 623 400 210
LW 88	8 621 901 700
LW 89	8 621 200 128
LW 90	8 620 105 427
LW 91	8 621 200 129
LW 92	8 621 901 698
LW 93	8 621 901 699
LW 94	8 621 300 152
LW 95	8 621 200 130
LW 96	8 621 300 153
LW 97	8 621 200 131
LW 98	8 620 105 438
LW 101	8 628 800 429
LW 102	8 628 800 420
LW 103	8 622 002 103
LW 104	8 628 800 422
LW 105	8 628 800 423
LW 106	8 621 901 722
LW 200	9 623 400 227
LW 201	8 623 400 211
LW 203	8 620 105 429
LW 204	8 620 105 430
LW 205	8 623 400 216
LW 206	8 620 105 436
LW 207	8 623 400 232
LW 208	8 620 105 431
LW 209	8 620 105 432
LW 210	8 620 105 437
LW 211	8 623 400 215
LW 212	8 620 105 433
LW 213	8 620 105 434
LW 214	8 620 105 435
LW 217	8 623 400 213
LW 218	8 623 400 214
LW 219	8 623 400 217
DV 103	8 624 400 253
K 9	8 627 609 509
H 10	8 908 003 512
L 36	8 624 200 607
PL 38	8 628 309 769
H 39	8 908 003 513
H 40	8 908 003 514
D 42	8 905 405 342
M 68	8 627 205 766



Position Position Position Posición	Bezeichnung Designation Dénomination Denominación	Bestell-Nr. Part no. No. de commande Número de pedido
		
B 1001	14V/100 mA GELB	1 907 598 275
B 1002	14V/100 mA GRÜN	8 928 410 035
		
D 1	BB 814	8 925 405 146
D 2	BB 814	8 925 405 146
D 3	BB 814	8 925 405 146
D 4	BA779S-GS 08	8 925 405 530
D 50	Z47 SB14692	8 925 421 048
D 51	Z47 SB14692	8 925 421 048
D 340	BAL 99	8 925 405 137
D 635	BB 512 (Sydney)	8 925 405 159
D 650	BB 512 (Sydney)	8 925 405 159
D 720	BAL 99	8 925 405 137
D 721	BZX 84/B10	8 925 421 068
D 860	BZX 84 C5V1	8 925 421 062
D 867	BAL 99	8 925 405 137
D 1000	TLR 226	8 905 405 416
D 1010-		
D 1023	LY 3380-GK E7504;	8 925 405 254
D 1040	BZX84C9V1	8 925 421 034
D 1680	BAW 56	8 925 405 015
D 2000	S 3 G	8 925 405 023
D 2020	BAX 14	8 925 405 069
D 2050	BZX 84/B9V1	8 925 421 065
D 2091	BZX 84 C5V1	8 925 421 062
D 2430	BAL 99	8 925 405 137
D 5350	BAV 70	8 925 405 122
D 5351	BAW 56 L	8 925 405 015
		
F 152		8 948 417 025
F 635	(Sydney)	8 948 415 044
F 636	(Sydney)	8 948 412 068
F 660	(Sydney)	8 948 413 008
		
L 1		8 958 411 000
L 3		8 958 411 000
L 5	4 µH	8 928 411 137
L 50	4 µH	8 928 411 137
L 650	(Sydney)	8 948 415 059
L 651	(Sydney)	8 948 415 048
L 700	12 µH	8 928 411 035
L 701	0,47 µH	8 928 411 045
L 2000	300 µH	8 948 411 065
L 2007	220 µH	8 928 411 038
L 2400	12 µH	8 928 411 035
		
Q 310	(Coburg)	8 946 193 307
Q 310	(Sydney)	8 946 193 307
Q 850		8 926 193 002
Q 851	(Coburg)	8 946 193 233
Q 851	(Sydney)	8 946 193 233
Q 660	(Sydney)	8 946 193 248
Q 2450		8 926 193 001

Position Position Position Posición	Bezeichnung Designation Dénomination Denominación	Bestell-Nr. Part no. No. de commande Número de pedido
		
R 191	10 kΩ	8 921 500 002
R 1250	2,2 kΩ	8 921 500 009
R 1260	2,2 kΩ	8 921 500 009
R 1595	100 kΩ	8 941 460 063
		
V 1	BF 999	8 925 705 280
V 2	BC 858 C	8 925 705 039
V 152	TDA 4220-X	8 925 900 988
V 310	TDA 1591 T	8 925 900 977
V 340	BC 848 B	8 925 705 043
V 360	BC 848 B	8 925 705 043
V 600	BF 545C (Sydney)	8 925 705 185
V 620	BF 543 (Sydney)	8 925 705 184
V 625	BC 848 (Sydney)	8 925 705 037
V 636	BC 848 (Sydney)	8 925 705 139
V 638	BC 848 (Sydney)	8 925 705 037
V 650	BC 848 (Sydney)	8 925 705 139
V 655	BC 848 (Sydney)	8 925 705 139
V 659	BC 848 (Sydney)	8 925 705 037
V 660	TDA 1072A (Sydney)	8 925 900 247
V 700	SDA 4330 2X	8 925 901 029
V 720	BC 848 B	8 925 705 043
V 850	TMP47C860F	8 925 901 506
V 851	BC 858 C	8 925 705 039
V 870	BC 848 B	8 925 705 043
V 1000	UPD 7229AGF	8 925 900 312
V 1001	BC 818-40	8 925 705 228
V 1002	BC 818-40	8 925 705 228
V 1010	MC 33072 DR2	8 925 900 319
V 1040	BC 848 B	8 925 705 043
V 1150	TA 7705F(EL)	8 925 900 012
V 1250	HA 12135 AFPEL	8 925 900 229
V 1302	BC 848 B	8 925 705 043
V 1500	TDA 4390 X	8 925 900 920
V 1570	LM 837 MX	8 925 900 205
V 1580	BC 818-25	8 925 705 041
V 1581	BC 818-25	8 925 705 041
V 1582	BC 818-25	8 925 705 041
V 1583	BC 818-25	8 925 705 041
V 1590	BC 858B	8 925 705 038
V 1650	TDA 7374V	8 945 903 239
V 1660	TDA 7374V	8 945 903 239
V 2020	L4949ND	8 925 900 348
V 2040	BC 848 C	8 925 705 037
V 2041	DTA143ZKTD	8 925 705 233
V 2042	DTC143ZKTD	8 925 705 234
V 2043	DTC143ZKTD	8 925 705 234
V 2045	BC 848 B	8 925 705 043
V 2065	BC 858 C	8 925 705 039
V 2070	BC808-25	8 925 705 042
V 2075	DTC 144VKTD	8 925 705 198
V 2076	DTC 144VKTD	8 925 705 198
V 2400	TMS375C006	8 925 901 522
V 2402	BC 848 B	8 925 705 043
V 2430	BC808-25	8 925 705 042
V 2431	DTC 144VKTD	8 925 705 198
V 2432	BC808-25/L	8 925 705 042
V 2470	BC 848 B	8 925 705 043
V 2472	BC 858B	8 925 705 038

Position Position Position Posición	Bezeichnung Designation Dénomination Denominación	Bestell-Nr. Part no. No. de commande Número de pedido
V 2475	BC 858B	8 925 705 038
V 2477	BC 848 B	8 925 705 043
V 2480	BFR 30	8 925 705 131
V 2500	TDA 7332	8 925 900 477
V 5350	BC 848 B	8 925 705 043
V 5351	BC 848 B	8 925 705 043
V 5360	BC 848 B	8 925 705 043
V 5361	BC 848 B	8 925 705 043
V 5370	BC 848 B	8 925 705 043

Position Position Position Posición	Bezeichnung Designation Dénomination Denominación	Bestell-Nr. Part no. No. de commande Número de pedido
<p>Hinweis: Handelsübliche Kondensatoren und Widerstände sind in der Ersatzteilliste nicht aufgeführt. Wir bitten Sie, diese Teile im Fachhandel zu beziehen.</p> <p>Nota: Des condensateurs et résistances commerciaux ne sont pas inclus dans la liste des pièces détachées. Veuillez acheter ces pièces chez votre spécialiste.</p>		
<p>Note: Capacitors and resistors usual in trade are not mentioned in the spare parts list. Kindly buy these parts from the specialized trade.</p> <p>Nota: No se indican en la lista de piezas de requestos los condensadores y los resistores de uso comercial. Les rogamos comprar esas piezas en el comercio especializado.</p>		

Blaupunkt-Werke GmbH, Hildesheim

Änderungen vorbehalten! Nachdruck - auch auszugsweise - nur mit Quellenangabe gestattet!

Modification réservées! Reproduction - aussi en abrégé - permise seulement avec indication des sources utilisées.

Gedruckt in Deutschland
Printed in Germany by
HDR

Modification reserved! Reproduction - also by extract - only permitted with indication of sources used
¡Modificaciones reservadas! Reproducción - también en parte solamente permitida con indicación de las fuentes utilizadas.