

FIGURE 2 : CIRCUIT DIAGRAM OF THE TA-802 LOUDSPEAKER PROTECTOR UNIT.

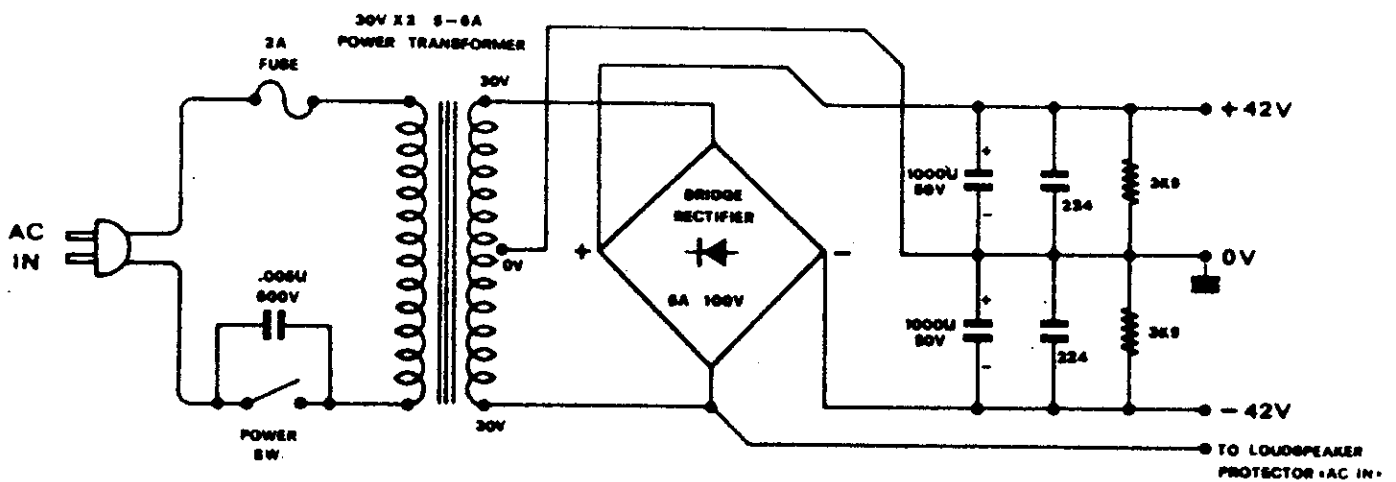

FIGURE 3 : THE POWER SUPPLY FOR TA-802.



LED



A 854  
C1741  
BC637  
BC638



K34

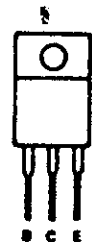

D712  
B682  
T3228

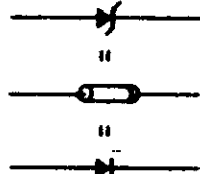

IN4148  
IN4001  
24V ZENER

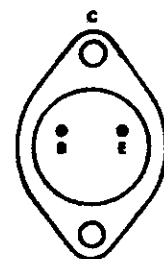

D665  
6645

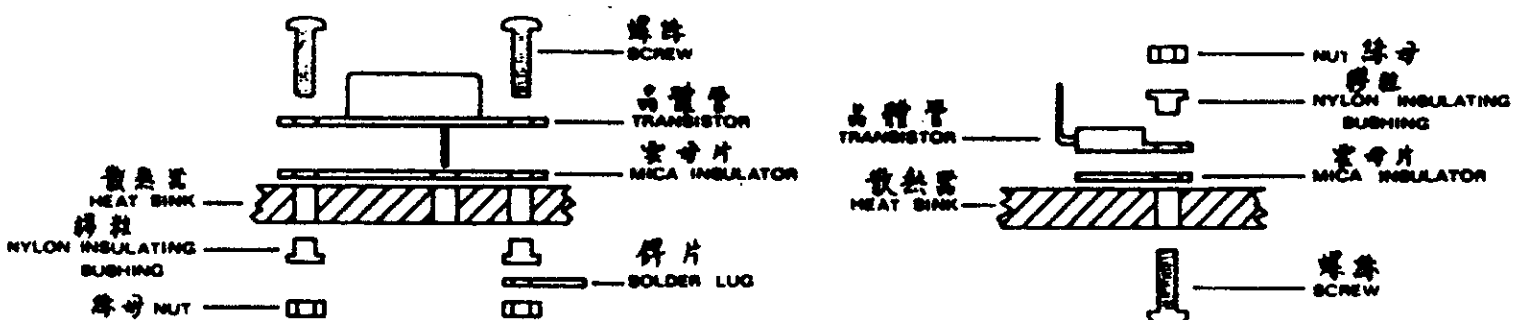

METHODS OF MOUNTING TO2 & TO3 TRANSISTORS ON HEAT SINK

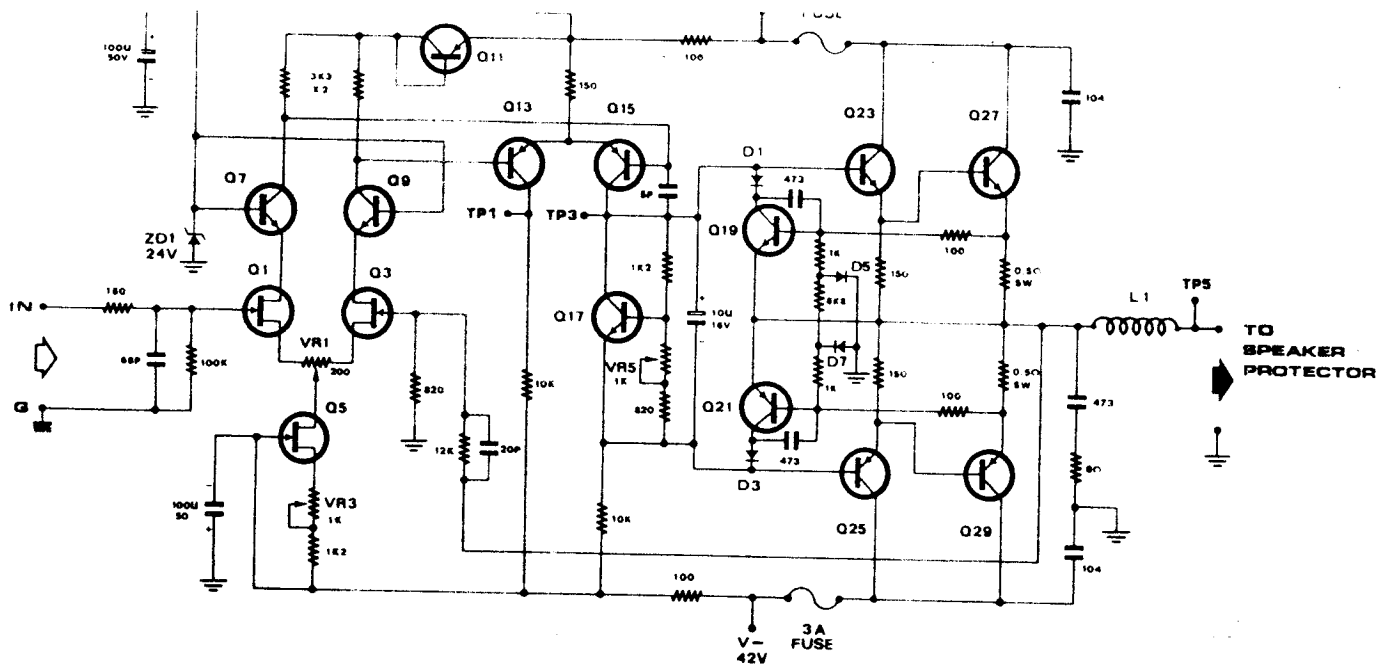

FIG 1:- CIRCUIT DIAGRAM OF THE LEFT CH. POWER AMP. UNIT.

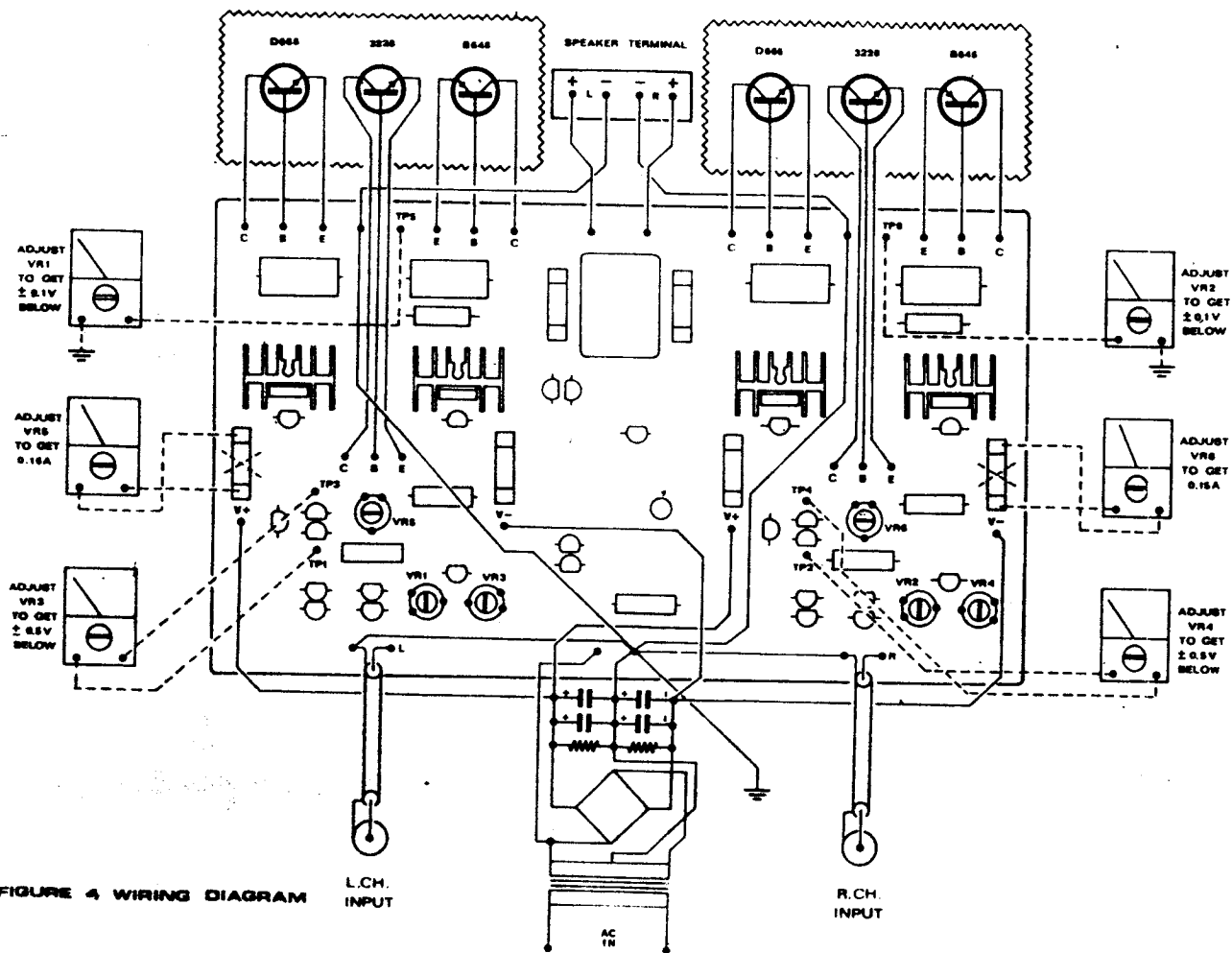

FIGURE 4 WIRING DIAGRAM