

# Building A Noise Gate

By Jon Gaines

One of the big problems facing the small studio owner is assigning priorities for equipment purchases. You'd like to have access to all the gear that helps produce that great "studio sound" you're after, but reality may dictate buying another microphone instead of a compressor, a better reverb unit instead of a digital delay. One piece of auxiliary equipment that always seems just out of reach is the noise gate, which is unfortunate since these simple devices can go a long way toward helping you get a tight, clean sound. This article presents a professional quality noise gate design that you can build yourself for a fraction of the cost of commercial units.

The project is fairly simple and is recommended for anyone who has had a moderate amount of construction experience. There are no exotic, hard-to-find components involved, and the semiconductors can take a fair amount of handling without fear of damage.

### Noise Gate Applications

The term "noise gate" is derived from the device's use as a gate or switch to eliminate noise from an audio signal. Unlike an expander, the noise gate has only two active states of operation—on or off. In use, it is adjusted so that the audio signal fed into it is either switched on, in which case you'll hear it at the output of the noise gate, or it is switched off, in which case the output is silent.

As a typical example, consider a drum track in a multi-track recording. Between beats of the bass drum,

you normally hear some leakage, consisting of noise from the other drums and cymbals, leakage from the bass player's amp, a guitar amp and whatever else was happening in the room at the time of the recording. At mixdown time, this leakage, combined with leakage on other tracks, can contribute to a muddy, loose sound. By routing the bass drum track through a noise gate, leakage is totally eliminated, since the gate is on at the instant when the beater strikes the head of the drum, and off at all other times. With a noise gate on each drum track in a typical set, the improvement in overall sound can be spectacular.

While cleaning up drum tracks is one of my favorite applications for noise gates, they have many other uses in sound reinforcement and perfor-

mance as well. In a sound system, gates can automatically turn off unused microphones or groups of mics, giving a sound system better clarity by reducing leakage, and reducing the possibility of feedback by keeping the number of "live" mics to a minimum. Performing musicians can use gates as the link between their other effects and their amplifier, cutting out all the hiss, hum and buzz that might otherwise come out of their amp when they're not playing.

### Operational Controls

How does the noise gate know what to pass and what to reject? This is primarily determined by the Threshold control, which establishes a fixed operating point, called the threshold. Any audio signal entering the noise

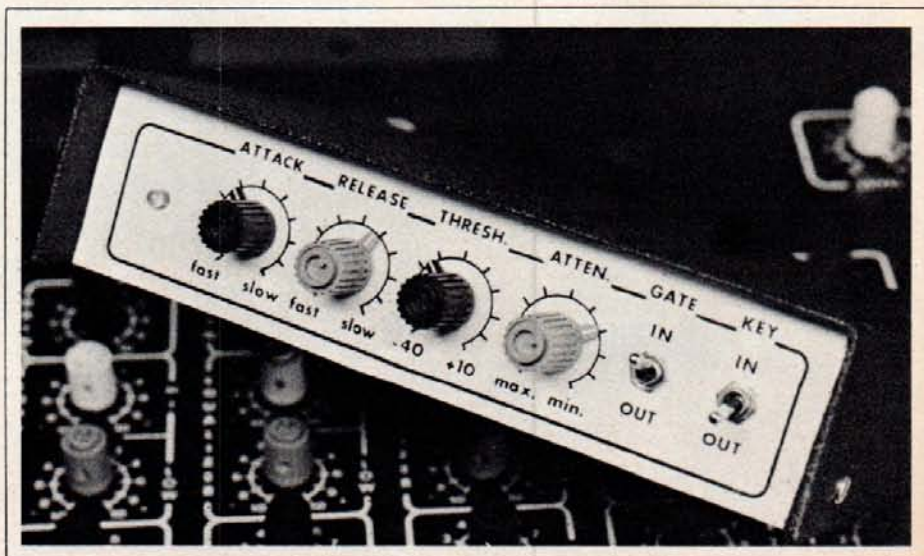



gate will either be below or above the threshold point. If below, the gate will remain off, and the output will be silent. As soon as the volume of the incoming musical signal reaches a critical voltage level, the gate switches on and the audio signal appears at the output. In practice, you simply rotate the threshold control until you find the point at which the gate is able to differentiate between music and noise.

In the design presented here, an LED indicator is included to give a visual indication of the noise gate's on and off states; the LED lights as soon as the audio signal has reached threshold.

Three other variable controls are used to make the gate respond effectively to different types of program material.

The Attack Time control determines how quickly the gate turns on after threshold is reached, ranging from a few microseconds to a few milliseconds. In most applications, a very fast response is desirable to prevent clipping off the beginning of any musical attacks.

Release Time determines how quickly the gate returns to its off state after the input signal has fallen below threshold. When gating drum tracks, I usually use a very fast release time so that the drum track is only heard at the instant when the stick hits the head. For more sustained types of material, such as guitar solos, a slow release insures that the end of a note won't get cut off. Not only does the gate stay on longer after the signal drops below threshold, but the rate at which it shuts off slows down as well, more closely approximating your hand pulling down a fader.

The Maximum Attenuation control allows you to determine to what extent the noise gate mutes the music when it is in the off state. Normally, you'll want the noise portion of the input signal to be muted as much as possible, in which case the attenuation control is set at maximum. In some instances, however, a track which abruptly changes between sound and silence won't be sufficiently masked by the other tracks, and the resulting change in ambience could be noticeable. In that case, you can adjust the attenuation control to achieve a usable compromise between noise reduction and musical coherence.

The Gate switch allows you to make

quick A-B comparisons between the original input signal and the processed output; when switched out, the input is hardwired to the output.

Finally, a Key switch makes it possible to use some external trigger to control the gating function. In normal operation, an instrument triggers its own gate; the attack of the kick drum turns on the gate that allows the sound of the kick drum to pass. But suppose you want an instrument to be turned on and off by a signal other than its own rhythmic attack. The key switch makes this possible. This use of the noise gate falls under the category of "special effects," and later on I'll offer some examples of its application.

### Before You Start

The ultimate success of any build-it-yourself project depends largely on good planning and careful attention to

detail. There's nothing so frustrating as soldering in the last part, flipping on the power and hearing silence where you should hear music. While this is likely to happen occasionally, you needn't be resigned to it.

Here are a few general rules:

1) Use only resin core solder for electronics work. Acid core is great for plumbing, but can utterly ruin a low-noise circuit.

2) Use a medium heat iron, 30 to 40 watts, clean and well tinned. Iron-clad tips tend to keep their shape longer than plain copper tips. Keep a damp sponge or an old rag on your bench to occasionally wipe the crud off the tip.

3) Soldering. The secret of good soldering is to bring the connection to be soldered up to temperature as quickly as possible, melt on a small amount of solder and let the joint

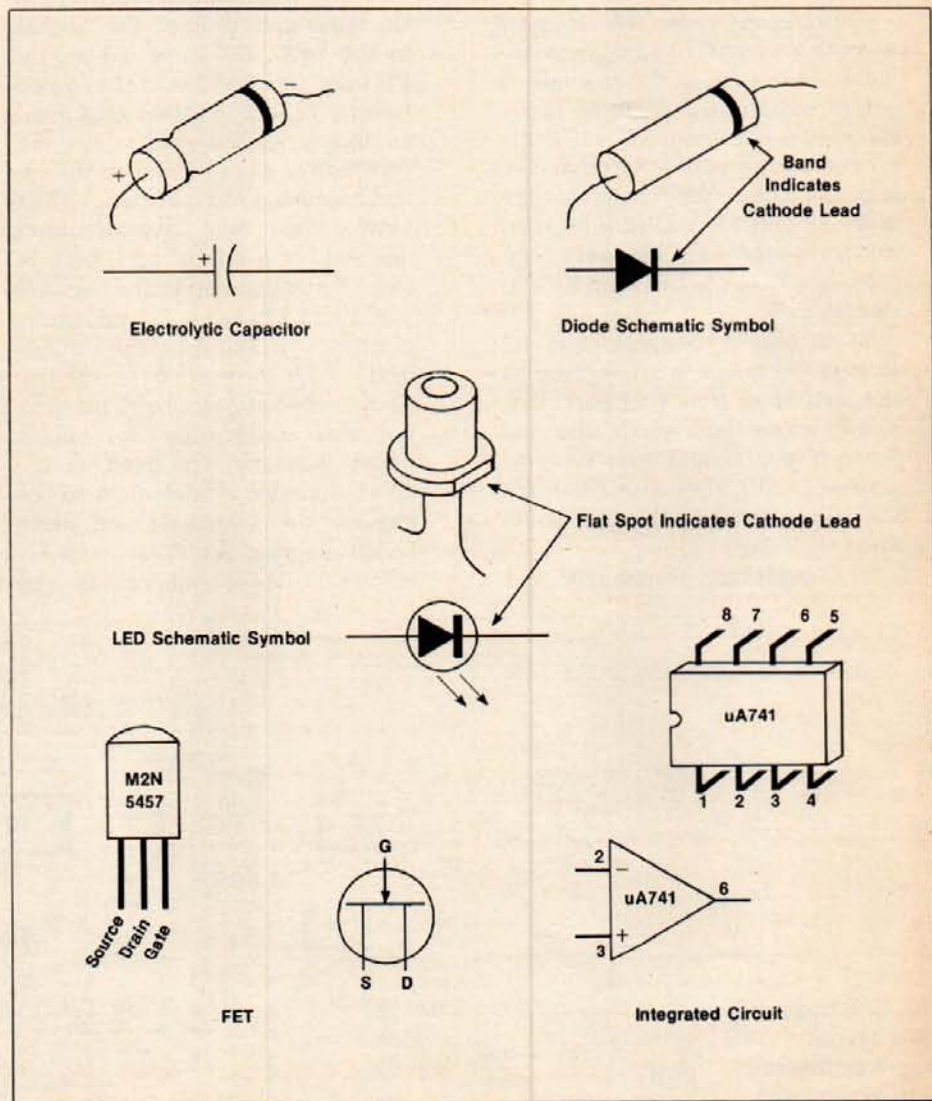

Fig. 1: Component polarities and schematic symbols.



cool without moving. Put another way, the object is to "get in and get out" as quickly as possible. Where a lot of people seem to have trouble is that first part, heating the joint. It's almost impossible to heat a joint with a dry tip; the component will get awfully hot, but the joint refuses to melt solder. Therefore, it's important to prime the soldering iron with a small bead of molten solder, and then hold the molten solder against the joint. The effective surface area of the tip is greatly increased, and the heat transfer is almost instantaneous. Now you can melt an additional bit of solder onto the joint, and then remove the iron as soon as the solder has flowed all around the connection. If you follow this routine, the whole process should take about one second, and it's nearly impossible to overheat a component.

Common sense will suggest ways to keep parts as cool as possible while soldering. For example, if you're soldering a diode in place, solder just one end of it, and, while it's cooling, go on to some other connection. Then come back to the diode after it has cooled a bit, and solder the other end. This advice applies equally to the LED and FET in this project.

4) Whenever possible, use IC sockets. Although it's tempting to eliminate them from your parts list, they're more than worth their expense if you should ever have to replace an IC. They also eliminate the possibility of overheating an IC while soldering.

5) Desoldering. Every now and

then, you'll be looking over your assembled circuit board, admiring your nice shiny solder connections and impeccable workmanship, when you suddenly realize that you've soldered a few parts in the wrong position. Getting the parts out is easy enough—simply reheat the solder and pull the components out. However, getting them in again can be a problem. If you just reheat the solder and try to poke the lead through the hole again, there's a 90% chance that you'll lift the copper foil pad away from the circuit board. Once off, it's nearly impossible to make it stick down again.

The solution is to clean all the solder away from the hole and let it cool completely before attempting reinsertion. Use either a suction type desoldering tool or a braided copper desoldering wick.

6) Pay attention to polarity. For the noise gate project, this applies to the LED, the three diodes, the FET and C2, the 22 microfarad electrolytic capacitor. Most caps have an indent at one end, which corresponds to the (+) sign on the circuit board and the schematic. Alternately, a cap may have a band at one end, or a minus sign, both of these corresponding to the negative end. The LED has a flat side on its plastic case, indicating the cathode lead, which corresponds to the line on the schematic symbol. This symbol also appears on the circuit board. Similarly, the band on the 1N4148 diodes is equivalent to the line on the schematic and parts layout diagram. See *Figure 1* for examples of these components and

their schematic representation. Also shown is the package and pin designation of the 2N5457 Junction Field Effect Transistor (JFET). The "gate" lead is the most critical one to get right on this device; drain and source can usually be interchanged with no effect on performance.

Note that ICs usually have a notch or hole at one end to designate Pin 1. This also corresponds to the notch or rounded-off corner on the IC socket, and to the notch indicated on the parts layout diagram.

7) Check your work and then double-check it. One of the variations on Murphy's Law states that if you double-check your work, no errors will be found, but if you don't check it, an error will exist. This principle naturally makes checking your work one of the least gratifying aspects of project building. Nonetheless, it's wise to try to get into the habit.

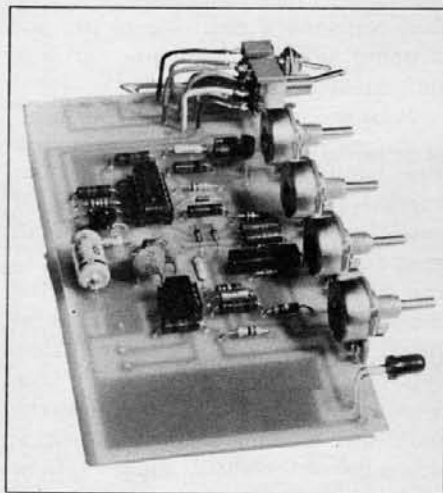

Fig. 3: Assembled noise gate.

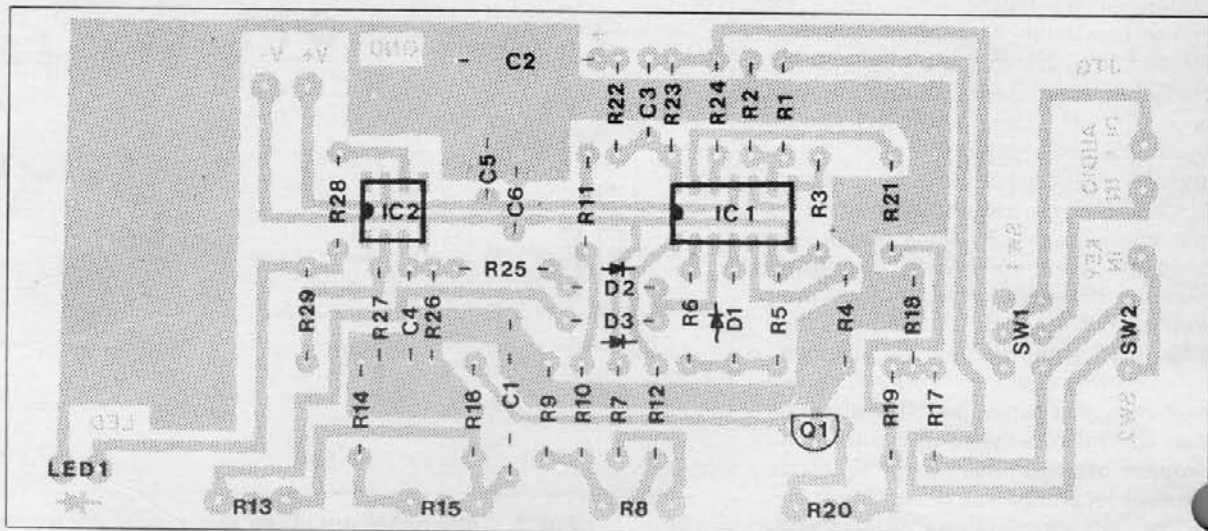

Fig. 2: PC board parts layout diagram (viewed from component side).



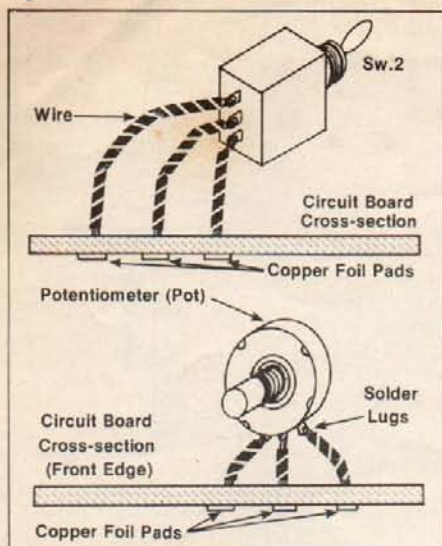

Fig. 4: Switch and pot insertion.

### Procedure

Check to see that you have all of the parts ready, and that they'll all fit into the circuit board in the designated places. It's a good idea to clean the copper side of the board with steel wool or a rubbing compound to make soldering easier. Also, check that there are no fine copper burrs left over from the drilling process, as a stray bit of copper can produce a hard to locate short.

If you're not using a printed circuit board to build this project, try to follow the general layout shown in the accompanying photos and diagrams. Remember that the TL075 is an extremely wide bandwidth amplifier; keep lead lengths as short as practical.

To begin, insert and solder the IC sockets, noting polarity. The sockets will serve as a reference point for all the other parts to be inserted. Follow-

ing the parts layout diagram (Fig. 2), insert and solder all of the resistors, capacitors and diodes. If the parts tend to fall out when you turn the PC board over to solder them, try holding them down with a piece of masking tape until they're soldered.

To insert the LED, you'll need to bend the leads outward slightly. Grasp the leads just below the case with a pair of needlenose pliers and then bend the leads with your fingers. This minimizes the stress on the leads and the transistor's plastic case. Use the same procedure to bend the leads for the LED; note that the flat spot on the case will be facing in toward the center of the PC board.

The PC board layout (Fig. 5) has been designed to reduce handwiring and confusion. The potentiometers I've used mount directly to the board, as illustrated in the photo (Fig. 3). Simply plug the pots in and solder. The advantage of this type of pot, besides the reduction of tedious wiring, is that the PC board becomes rigidly attached to the pots, and when the pots are mounted in the chassis, the physical mounting of the board itself is also accomplished. In most cases, no additional nuts and bolts are needed to secure the PC board. However, if your noise gate is going on the road, you might consider additional supports.

If you're using standard solder-lug pots, run wires from the pads on the board to the lugs on your pots, as if you were plugging your pots into the PC board (see Fig. 4).

The pads for the two switches have also been laid out to make their wiring as straightforward as possible. For ex-

ample, switch 1 is a DPDT, represented on the copper side of the board by six copper pads, only five of which are used. These six pads are the equivalent of the six solder lugs you'll find on the back of any miniature DPDT switch, with the two center pads representing the arm, or common, of the switch. To see how you wire this switch to the board, hold the switch with the solder lugs facing away from you, and imagine that you are plugging it right into the PC board pads—from the component side, of course. Now, attach five wires to the switch and insert them into their proper holes. (See Fig. 4 for additional clarification.)

That completes the insertion of all the components except the ICs themselves, which we'll put off for the time being. Your gate should look pretty much like the photograph at this point (Fig. 3).

### External Wiring

All that's really left to do is to hook up a power supply to the noise gate and connect the two inputs and one output. You can run this project from any standard  $\pm 15$ -Volt power supply. If you have built other projects that have appeared in *MR&M*, you already have such a supply handy. Because they are common and readily available, I have not included one in this article.

Attach the positive power supply lead to the pad marked V+, the negative supply lead to the pad marked V- and the power supply common to the copper foil area near the word GND.

If you are housing your project in a metal chassis, you can use un-

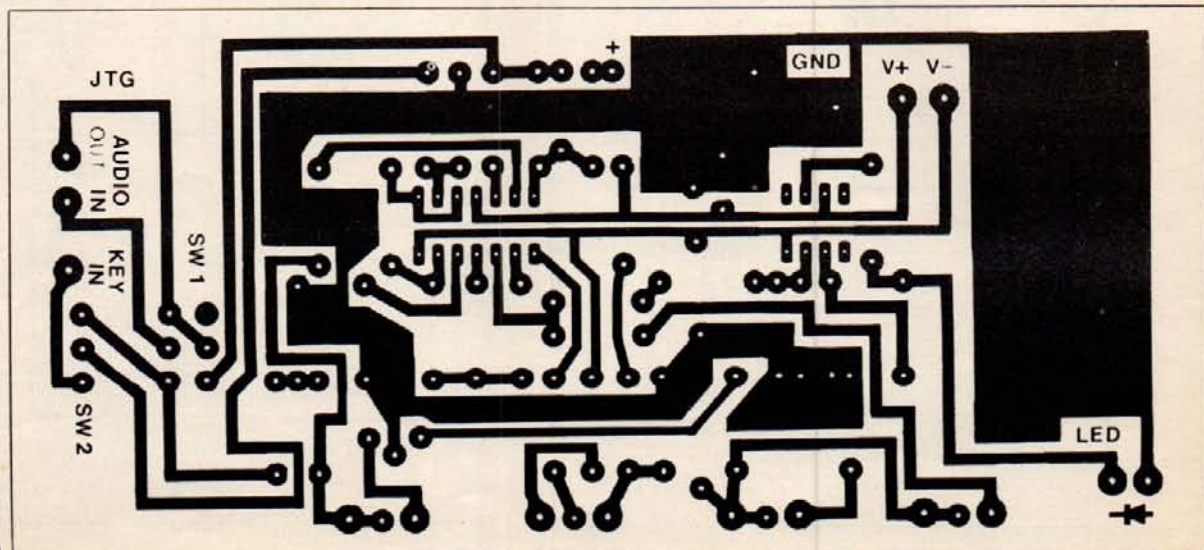
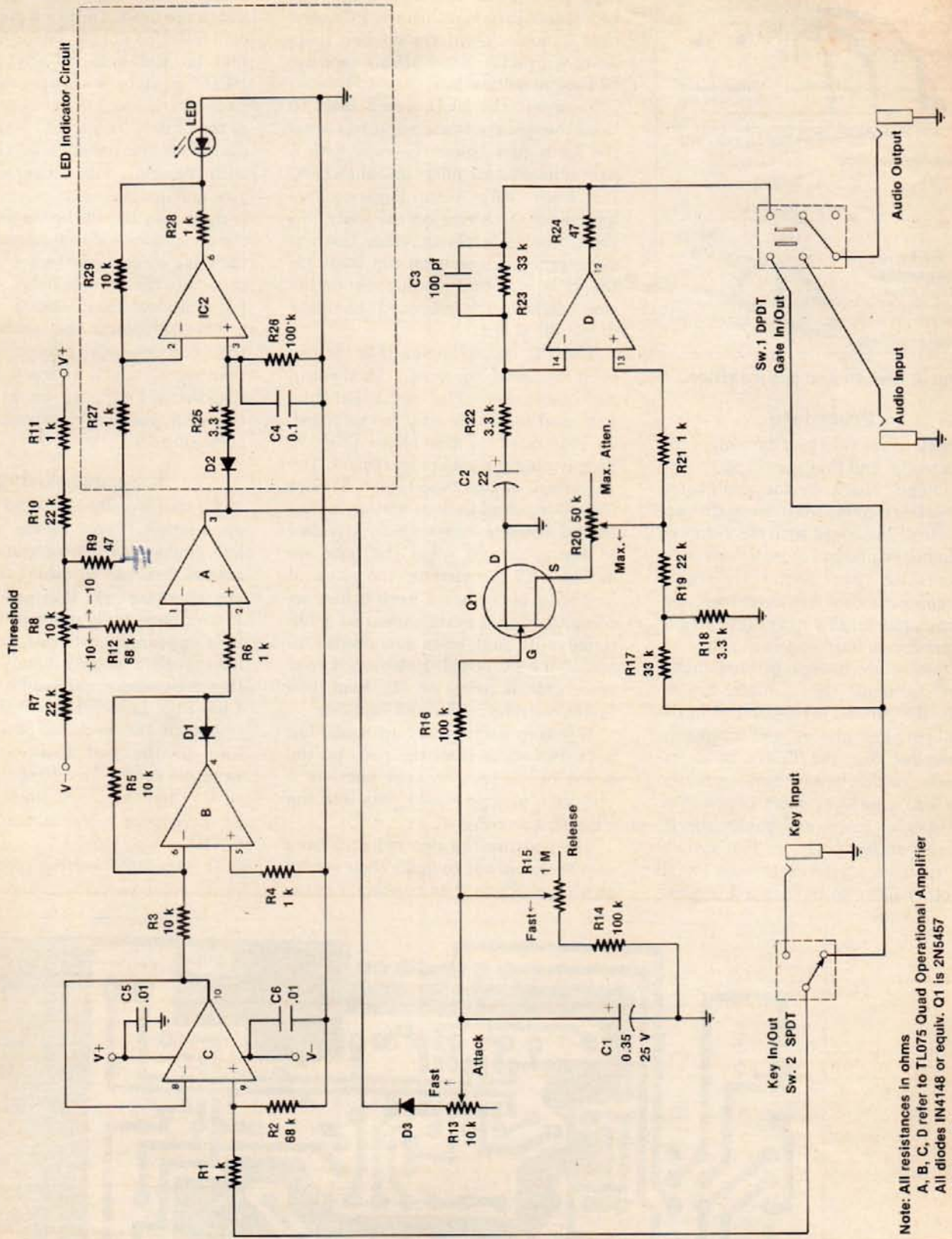

Fig. 5: PC board work (positive; viewed from copper side of board).





Note: All resistances in ohms  
 A, B, C, D refer to TL075 Quad Operational Amplifier  
 All diodes IN4148 or equiv. Q1 is 2N5457  
 IC 2 is a 741

Fig. 6: Schematic diagram.



shielded solid or stranded hookup wire to connect the input and output jacks. Use either RCA type or 1/4" phone jacks, depending on your particular application.

Label one of the jacks "Audio Input" and run a wire from its hot terminal to the pad marked AUDIO IN.

Label a second jack "Key In" and wire its hot terminal to the pad marked KEY IN.

Label the third jack "Audio Output" and wire it to the pad marked AUDIO OUT.

Lastly, ground all of the jacks to each other, either with a piece of hookup wire or through the metal body of the chassis, and ground the chassis to the circuit board, again at the point marked GND. The object is to have all of the audio grounds, power supply ground, chassis and PC board ground referenced to the same point.

As soon as you mount the unit in a suitable case, the construction phase of the project will be complete; this is a good time to go back and check your work. Verify component placement and polarity and look for shorts or unsoldered connections.

### Initial Test

Before you plug in the ICs, it's a good idea to check supply voltages. First, turn on the power supply, and using a DC Voltmeter, verify that the supply voltage is approximately  $\pm 15$  Volts. Next, check to be sure that you have +15 Volts at pin 11 of IC 1 and pin 7 of IC 2. Check for -15 V at pin 7 of IC 1 and at pin 4 of IC 2. Turn the power off again.

Connect a line-level music source to the Audio Input jack. Any tape or record will do, but the more dynamic range, the better. Connect the Audio Output of the noise gate to a monitor amplifier. Set the GATE IN/OUT switch to the OUT position. You should hear music at the output. If you don't, you either have the input and output jacks or SW. 1 incorrectly wired.

With the power still off, insert the two ICs. Turn all of the controls fully counterclockwise, set the GATE switch to the IN position and the KEY switch OUT. Turn on the power. The LED should now light, and you should hear music at the output.

Adjust the threshold control clockwise until the gate reaches the edge of threshold. The music will begin

### Noise Gate Specifications

(using TL075CN)	
Frequency Response:	10 Hz-22 kHz, + 0 dB, - 1 dB
Overall Gain:	Unity
THD (Gate On):	0.01% typical
Current Consumption:	+ 10 mA, - 22 mA
Maximum Power Supply Voltage:	$\pm 18$ Volts

### Parts List

<i>Resistors</i> - all 1/4 watt, 5% tolerance	
R1, R4, R6, R11, R21, R27, R28	1 K ohm
R2, R12	68 K
R3, R5, R29	10 K
R7, R10, R19	22 K
R8, R13	10 K Potentiometer, Linear
R9, R24	47 ohm
R14, R16, R26	100 K
R15	1 Megohm Potentiometer, Linear
R17, R23	33 K
R18, R22, R25	3.3 K
R20	50 K Potentiometer, Linear
<i>Capacitors</i>	
C1	0.35 microfarad, 25 Volt electrolytic
C2	22 microfarad, electrolytic 16 Volt
C3	100 picofarad disc or polystyrene, 15 Volt
C4	0.1 microfarad disc or polystyrene
C5, C6	0.01 microfarad disc
<i>Diodes</i>	
D1, D2, D3	1N4148 or 914
LED 1	Red
<i>Integrated Circuits</i>	
IC 1	TL075CN Low Noise Audio BIFET Op Amp, Quad
An acceptable substitute for IC 1 is the RC 4136 (Raytheon)	
IC 2	uA 741 Op Amp
<i>Transistor</i>	
Q1	Motorola 2N5457 N-channel JFET, or 2N5458 Substitute Radio Shack 2028, part # 276-2028
<i>Switches</i>	
SW 1	DPDT Toggle, miniature
SW 2	SPDT Toggle, miniature
<i>Miscellaneous</i>	
14 Pin IC Socket	
8 Pin IC Socket	
(3) RCA or 1/4" Jacks	
Circuit board, solder, wire, chassis, knobs	
A parts kit containing all of the above items, except chassis and solder, is available for \$44.95, and a circuit board alone is available for \$9.95. Order from:	
JTG Electronics 76 Smyles Drive Rochester, NY 14609	
Prices are postage paid. N.Y. Residents please add 7% sales tax.	

to cut in and out as the gate tracks the amplitude peaks. As you continue to turn the control clockwise, the sound will cut out completely since there is nothing of sufficient volume to turn the gate on. Experiment with this and the other controls to get a feeling for their functions. If you don't immediately hear the effect of the Attack time control, don't worry; its influence is subtle.

To check the external KEY function, plug another line level source into the Key Input jack and set the KEY switch to IN. Re-adjust the threshold control so that it tracks the new keying signal.

### Using Your Noise Gate

You'll find that the gate is very easy to use and that the control settings are not particularly critical. If you are



# Still The Best!

- Flange
- Double
- Echo
- Vibrato
- Pitch resonance
- Doppler effects
- 95db typical
- 15kHz at all delay settings
- 512 mS of delay standard

Don't be deceived by lower priced imitations, the DL-4 Time Line™ is still the best high-quality, full-bandwidth, long-delay digital processor available today. You owe it to yourself to find out why



**DeltaLab Research, Inc**  
 27 Industrial Avenue  
 Chelmsford, MA 01824  
 Tel (617)256-9034  
 Telex #951205  
 Canadian Distributor  
 Heini Audio  
 Developments, Inc.  
 Markham, Ontario,  
 Canada (416)495-0688

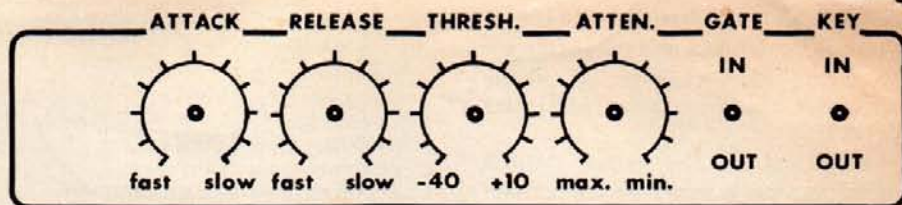

Fig. 7: Suggested front panel graphics.

using the gate in conjunction with other processing equipment, such as equalizers and compressors, it's usually best to make the noise gate the last link in the processing chain.

For example, an equalizer is typically used ahead of a compressor to keep it from mistracking due to subsonic noise. Similarly, you would want to eliminate any very low frequency junk that might cause false keying of the noise gate.

If you are gating a kick drum track and the drummer did not play with a consistent attack, there may be a tendency for the gate to "miss" a lightly struck beat now and then. One solution is to lower the threshold level slightly, allowing the gate to respond to the softer kicks. However, this may also allow more noise to sneak by, as the gate's threshold has been shifted closer to the track's noise level. An alternate solution is the judicious use of a compressor just ahead of the gate. While their functions might seem contradictory, a little compression here can even out the drum track just enough so that the noise gate keys more accurately. By the way, it would be risky to use the gate when laying down original tracks, for the same reason just mentioned. If a musician doesn't play with a consistent attack, the gate may decide that the lighter beats are noise, and mute them.

## Special Effects

Keying a sound source with an external voltage offers interesting possibilities. To use the kick drum as an example once more, let's say you've just started a mixdown session and discover that the kick drum sounds like a baseball bat hitting an old cardboard box. You pour on the EQ and manage to make it sound like a sonic boom, but it still doesn't have much character. There's no time or money to overdub a new track. What to do?

Plug the kick drum track into the Key Input of the gate. Tune an oscillator to a 40 Hz sine wave and

plug that into the Audio Input of the gate. Route the output of the noise gate to the console input module that was being used for the kick drum track. Roll the tape once again, and you'll hear the oscillator turning on and off in time to the music. By tuning the oscillator, you can give the kick drum a definitive musical pitch. You might think that this trick would sound gimmicky and not very musical, but you'll be amazed at just how good a kick drum sound you can simulate this way. If you want to preserve a little of the original drum sound, mix the dry track and the gated oscillator together through two faders and adjust the ratio for the best sound.

Once you've become familiar with the concept of external keying, you'll think of lots of ways to create special effects with the noise gate.

## Modifications

If the noise gate presented here offers more control than you need, you can build a "stripped down" version by eliminating certain functions.

For instance, although the LED indicator is a handy aid in setting the threshold level and for monitoring the gate function, removing this part of the circuit won't effect the noise gate's other functions at all.

If you're willing to give up control of attack time and want a consistently fast response time, simply eliminate the attack time pot (R13), and short across the three copper pads on the circuit board where that pot would have been inserted.

The same applies to the release time pot and the maximum attenuation control, with a resultant fixed fast release and maximum attenuation in the off state.

If you don't plan on using the key option, leave out that switch and short across the three copper pads for SW. 2.

In some situations, you might want to extend the maximum release time by using a larger value pot for R15, say 2.5 M ohms.





# Noise Gate

**Open up the way to noise-free music with this versatile unit. It also doubles as an envelope shaper.**

By Ian Coughlan

EVERY MUSICIAN knows the problems caused by noisy leads and effect units: whenever you stop playing, the snaps, crackles and pops are still there. This may be acceptable for practising, but it's a major headache when recording or playing live. One solution is a noise-gate, the electronic equivalent of pulling the jack-plugs out every time you stop playing. In fact, the noise-gate does it so unobtrusively that you'd never know it was there.

Important parameters of a noise-gate

**Threshold:** this is the input signal level required to open the gate, and is adjustable from approximately  $-35\text{dBm}$  down to  $-65\text{dBm}$ . Normally it will be set just above the noise-floor, so that when playing begins, the increase in signal level is sufficient to open the gate.

**Response-time:** this is the time taken for the noise-gate to begin opening once the threshold has been crossed. Ideally it should be instantaneous, and in practise should be less than a millisecond and not adjustable.

**Attack-time:** the amount of time the gate takes to go from fully closed to fully open. Most noise-gates open instantly; this is what is usually required. This design will do so if you want, but it can also be adjusted to take up to 100ms to open.

**Hold-time:** this is the period for which the gate remains fully open after playing has stopped. It is adjustable between 100ms and 2s.

**Decay-time:** this is the time taken for the noise-gate to close after the Hold-time has elapsed. It is adjustable between 100ms and 2s.

As well as being triggered by the incoming signal, the noise-gate may also be triggered by another signal from the EXT KEY socket, by a logic level on the REM socket, by a switch contact (on the REM socket), or by the built in footswitch. Regardless of the triggering method used, the attack, hold, and decay controls still

function. Because the envelope shape is completely adjustable and the unit can be controlled by a variety of inputs, it can be used as an envelope shaper in its own right.

## Construction

Before soldering anything into place, check that the PCB has a hole under PR1 and, if not, carefully drill a  $1/4$  inch hole there. This will allow the preset to be adjusted from the underside of the board when the unit is assembled into its case. Start by installing the wire link, the jack sockets and, if desired, sockets for ICs 3 and 5. The jack sockets must be of the recommended type if they are to fit correctly into the prepared holes on the PCB.

Next, solder in the resistors and capacitors, making sure that capacitors near the connector end of the board are mounted flat so as to make room for the potentiometers when the board is mounted into the case. Fit the diodes, transistors and ICs 1, 2 and 4, which must be soldered directly to the board allowing clearance for the pots. Cut four pieces of ordinary connecting wire to the proper lengths and solder them between the points shown on the overlay. Next mount the works into a box the same size or larger than the one shown in Fig. 4.

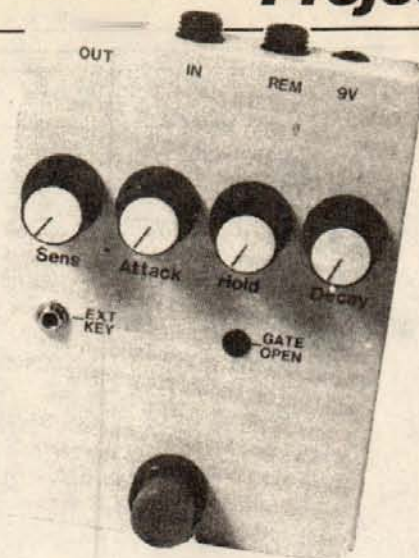

## Setting Up

Connect a 9V battery and apply a signal of about 2V peak-to-peak to the input. The LED should light up. Monitor the output with an oscilloscope or an AC millivoltmeter and adjust PR1 until the output level is the same amplitude as that of the input level. Once this has been set, leave it.

In use, the noise-gate should be connected between any effects and the amplifier or tape-recorder. The unit is switched on by connecting a mono jack to the input socket.

When doing the initial setup, turn the sensitivity control fully clockwise and the attack, hold, and decay fully counterclockwise. The LED should be off: if it isn't, press the footswitch. If using any effects, switch them on to produce all the noises you're trying to get rid of. Rotate the threshold control counterclockwise until the LED lights; at this stage you should be able to hear the noise getting through to your amplifier. Turn the threshold control slightly clockwise, raising the threshold to just above the noise-floor. The LED should go off, and the noise should stop.

As you play your instrument, the gate should open, and should close when you stop. The other controls are still set at

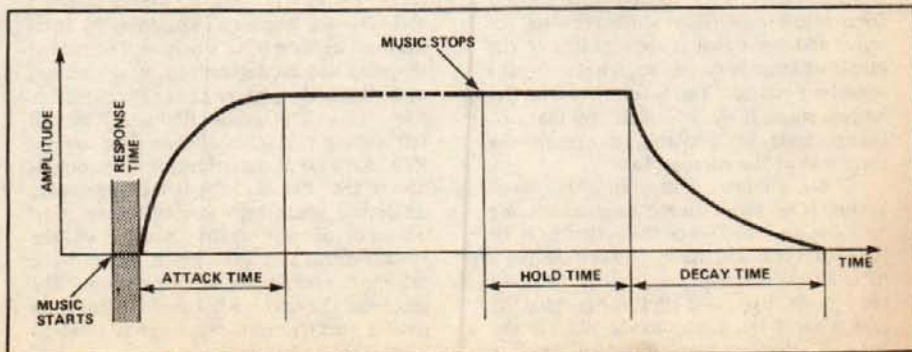

Fig. 1 The response envelope produced by the noise-gate.







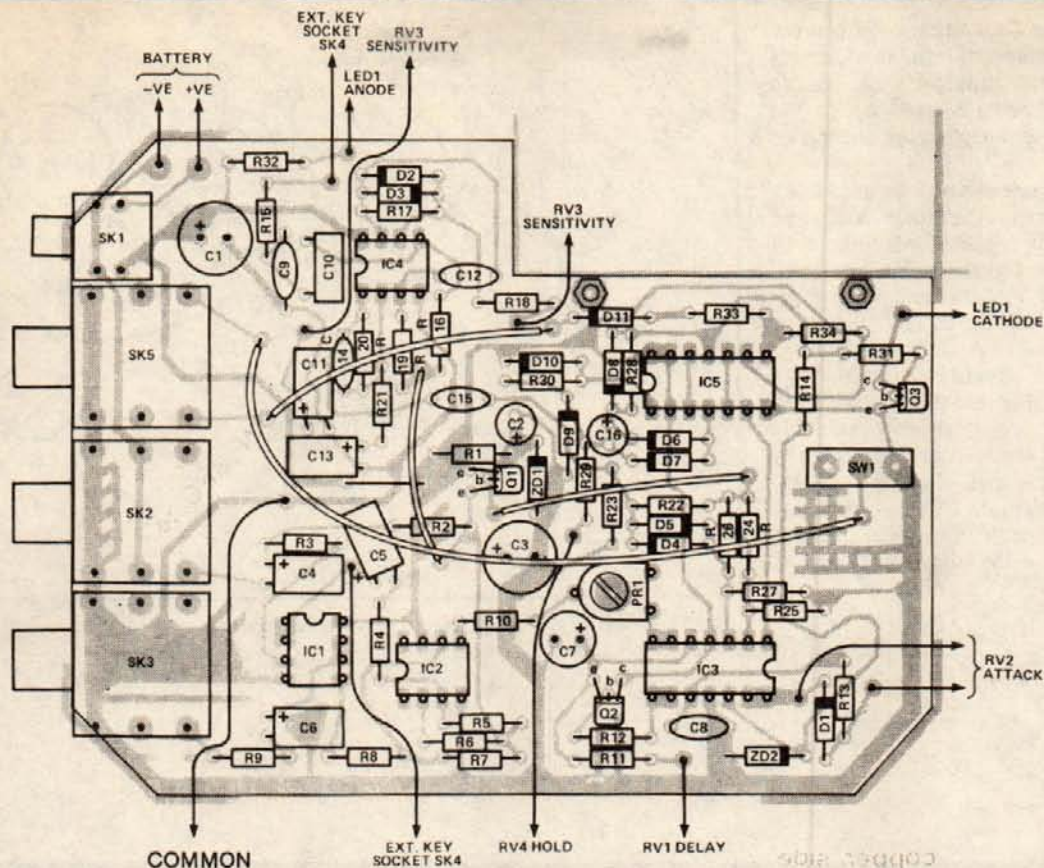

Fig. 3 The component overlay for the noise-gate PCB. Note the four wire links.

#### PARTS LIST

##### RESISTORS (all 1/4W, 5% unless otherwise stated)

R1	6k8
R2	470k
R3, 7, 30, 33	10k
R4	39k
R5, 6, 9	510R
R8, 11, 29, 34	100k
R10	910R
R12	1k0
R13, 14	22k
R15	12k
R16, 19	1M0
R17, 24, 27	220k 2%
R18	3k3 2%
R20	330k
R21	18k
R22, 23, 25, 26	200k 2%
R28	51k
R31	47k
R32	3k9
RV1, 2, 4	2M2 logarithmic
RV3	470k logarithmic
PR1	10k horizontal skeleton preset

##### CAPACITORS

C1, 3	100u 16V radial electrolytic
C2, 5, 6, 11, 13	10u 16V radial electrolytic
C4	1u0 16V radial electrolytic
C7, 16	1u0 35V tantalum bead
C8	47n multi-layer
C9	680p polystyrene
C10, 12	100n multi-layer
C14	15p polystyrene
C15	220n multi-layer

##### SEMICONDUCTORS

IC1	TL072
IC2	LM3080
IC3	LM324
IC4	TL062
IC5	4093
Q1-3	2N4401
D1-11	1N4148
ZD1,2	BZY88C 4V3
LED1	miniature red LED with mounting bezel

##### MISCELLANEOUS

SK1	3.5mm miniature jack socket, PC mounting, with switch
SK2	1/4" stereo jack socket, PC mounting, with switch
SK3	1/4" mono jack socket, PC mounting
SK4	3.5mm miniature jack socket, panel mounting, with switch
SK5	1/4" mono jack socket, PC mounting, with switch
SW1	SPDT alternate action push switch, panel mounting
PCB;	case; knobs, (4); battery connector; and screws or bolts to suit; 14-pin DIL IC sockets, (2); thin foam rubber; 9V battery.



minimum and should now be set to suit.

Pressing the footswitch will open the noise-gate regardless of input level, and is very useful when tuning-up. A remote footswitch can be connected up to the REM socket, disconnecting the unit's own footswitch.

The noise-gate can also be used as an envelope shaper with the attack, hold, and decay cycle being triggered in a number of ways. An audio signal can be connected via the EXT KEY socket and will trigger the envelope shaper but still allow the threshold control to be used. Alternatively, the EXT KEY should be shorted with a miniature jack plug and the unit triggered from the REM socket either by making and breaking a mechanical contact or by applying a logic signal. Closing the REM contacts or applying a 0V level will close the gate, while opening the contacts or applying a +5 to +15V signal will open it.

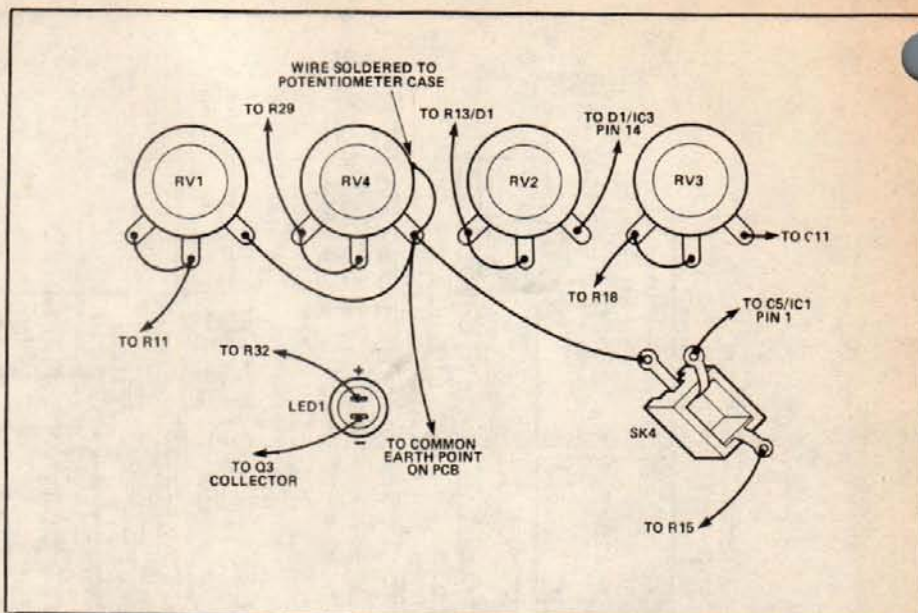

Fig. 5 Connecting details for the front panel components.

# NEXT MONTH IN Electronics Today

## oscilloscopes!

The microchip industry has revolutionized more than computers: features formerly out of reach to all but huge labs are now available for the average testbench.

## Reviews!

DCNAP circuit analysis software, the Cross-8 assembler program, and the Zopan function generator.

## A Guide To Transformers

Find out the true meaning of life, or at the very least the true meaning of transformer specifications and how to select them for your needs; a guide for pros and beginners alike.

## Large Digit Scoreboard

Build your own triac-driven scoreboard with digits as large as you'd like.

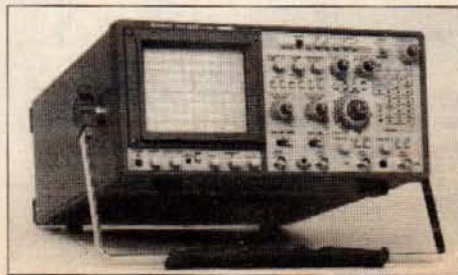

For Subscription or Advertising Information Call (416) 423-3262



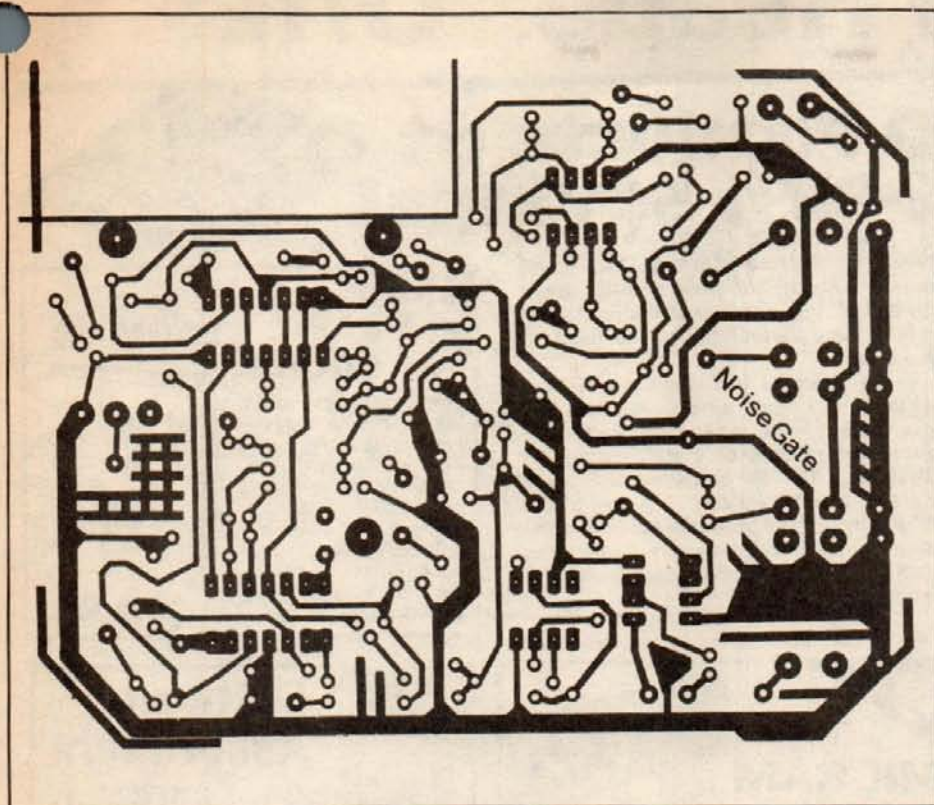

6 The PCB for the noise-gate.

50 Top Projects

156 Pages

\$4.95



Fifty all-time best projects from ETI magazine packed into one giant 156 pages special. There are projects for the beginner to the more advanced builder, including: Semiconductor Tester, Universal Counter, LED Level Meter, AM radio, and much, much more.

**ORDER TODAY FROM**  
**Moorshead Publications**, 25 Overlea Boulevard,  
 Toronto, Ont. M4H 1B1 (416) 423-3262  
 Postage and Handling included.  
 Credit Card payment accepted

## This Month in

# Computing! NOW!

### Boards of the Rings

Computing Now! takes a three hundred baud odyssey around the continent checking out the most interesting bulletin boards. Some of these things are intensely useful... others are extremely weird. Many are extremely specialized, and offer all sorts of new insights into things like the space shuttle and electric music. Did you know there's a Greatful Dead board?

### Patching WordStar on the PC

There are a lot of things about the IBM implementation of WordStar that its users would dearly love to change. This month we take a shot at adapting WordStar to make it convenient for your applications. You can patch it, change its defaults and generally make it into what you want it to be, rather than the other way round.

# Software NOW!

### Local Area Networks:

An examination of various systems and applications with a focus on new products from Novel, Corvus and The Software Link.

### Keyboard Enhancement Software:

Programs that let you integrate and streamline your applications with timesaving macro commands: a comparison of the newest versions of Prokey, Smartkey and Superkey.

### Utilities:

An assortment of public domain and commercial printer utilities to help you get the most out of your printer.

For Subscription or Advertising Information Call (416) 423-3262