



## AUDIO PROCESSOR with BBE Sound Enhancement & Passive Matrix TruSurround Virtualizer & TruBass

### ■ GENERAL DESCRIPTION

The **NJW1169** is an audio processor with Passive Matrix TruSurround Virtualizer, TruBass and BBE sound enhancement. It includes all of functions processing audio signal for TV, such as volume, balance, tone control, "eala" NJRC Surround, simulated stereo, mute function, line out and AGC function.

All of internal status and variables are controlled by I<sup>2</sup>C BUS. It is suitable for any TV set.

### ■ PACKAGE OUTLINE

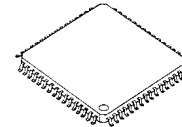

**NJW1169FH1**

### ■ FEATURES

- Operating Voltage                      8 to 13V
- I<sup>2</sup>C BUS Interface                      Fast mode
- Passive Matrix TruSurround
- TruBass Function
- Subwoofer Output
- "eala" (NJRC Surround) & Simulated Stereo
- Volume                                      0 to -80dB(0.33dB/step), MUTE
- Balance                                      0 to -30dB(1dB/step), MUTE
- Tone Control                              Bass/Middle/Treble, ±15dB(0.5dB/step)
- Bi-CMOS Technology
- Package Outline                          QFP64-H1

### ■ BLOCK DIAGRAM

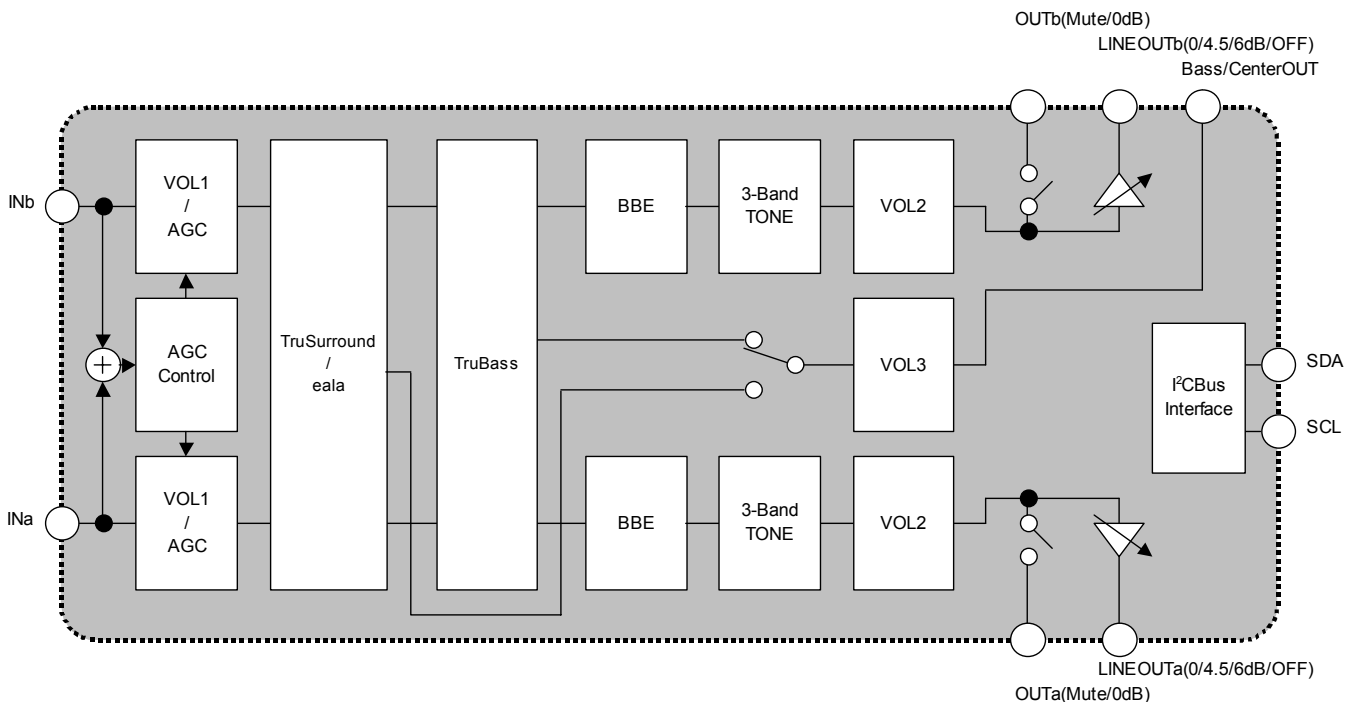

## ■ PIN CONFIGURATION (QFP64)

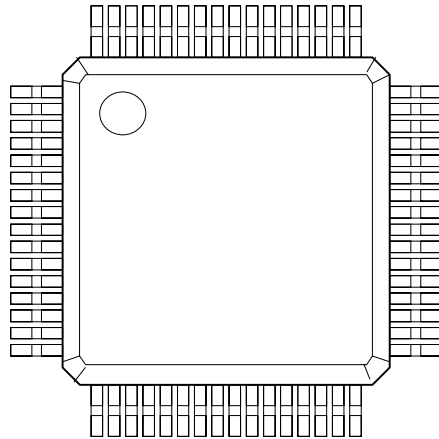

No.	SYMBOL	FUNCTION	No.	SYMBOL	FUNCTION
1	HPF1a	Ach HPF for TruBass Capacitor 1	33	OUTb	Bch Output (0dB)
2	HPF2a	Ach HPF for TruBass Capacitor 2	34	LINEOUTb	Bch Lineout (0/4.5/6.0/Mute)
3	HPF3a	Ach HPF for TruBass Capacitor 3	35	INb	Bch Input
4	TS1	TruSurround Filter Capacitor 1	36	Tone-Lb	Bch Tone (Treble) Filter
5	TS2	TruSurround Filter Capacitor 2	37	Tone-M2b	Bch Tone (Middle) Filter 2
6	TS3	TruSurround Filter Capacitor 3	38	Tone-M1b	Bch Tone (Middle) Filter 1
7	VREFOUT	Reference Voltage Output	39	Tone-Hb	Bch Tone (Treble) Filter
8	BBE-La	Ach BBE Filter (Lo Contour)	40	BBE-Hb	Bch BBE Filter (Process)
9	BBE-Ha	Ach BBE Filter (Process)	41	BBE-Lb	Bch BBE Filter (Lo Contour)
10	Tone-Ha	Ach Tone (Treble) Filter	42	SRS4	SRS Filter Capacitor 4
11	Tone-M1a	Ach Tone (Middle) Filter 1	43	SRS3	SRS Filter Capacitor 3
12	Tone-M2a	Ach Tone (Middle) Filter 2	44	SRS2	SRS Filter Capacitor 2
13	Tone-La	Ach Tone (Bass) Filter	45	SRS1	SRS Filter Capacitor 1
14	INa	Ach Input	46	HPF3b	Bch HPF for TruBass Capacitor 3
15	LINEOUTa	Ach Lineout (0/4.5/6.0/Mute)	47	HPF2b	Bch HPF for TruBass Capacitor 2
16	OUTa	Ach Output (0dB)	48	HPF1b	Bch HPF for TruBass Capacitor 1
17	Bass /CenterOUT	Bass/Center Output	49	ealaFil	eala Filter Capacitor
18	AGCSENSE	AGC Boost Level Setting Terminal	50	CENTER	SRS CENTER Effect Control Terminal
19	AGCINT	AGC Attack & Recovery Time Setting Terminal	51	SPACE1	SRS SPACE Effect Control Terminal 1
20	VOLATC	Pop Noise Reduction for Ach Volume Control	52	SPACE2	SRS SPACE Filter
21	VOLBTC	Pop Noise Reduction for Bch Volume Control	53	BPF3OUT	BPF Output for TruBass Terminal 3
22	SDA	I <sup>2</sup> C Data Input	54	BPF3IN	BPF Input for TruBass Terminal 3
23	SCL	I <sup>2</sup> C Clock Input	55	BPF2OUT	BPF Output for TruBass Terminal 2
24	GND	Ground	56	BPF2IN	BPF Input for TruBass Terminal 2
25	V+	Power Supply	57	BPF1OUT	BPF Output for TruBass Terminal 1
26	VREFIN	Reference Voltage Stabilizing Capacitor	58	BPF1IN	BPF Input for TruBass Terminal 1
27	OUTTC	Pop Noise Reduction for Lineout Gain Setting	59	LPFOUT	LPF Output for TruBass
28	TONELTC	Pop Noise Reduction for Tone (Bass) Control	60	LPF2	LPF for TruBass Capacitor Terminal 2
29	TONEMTC	Pop Noise Reduction for Tone (Middle) Control	61	LPF1	LPF for TruBass Capacitor Terminal 1
30	TONEHTC	Pop Noise Reduction for Tone (Treble) Control	62	TBCONT	TruBass Punch Control Terminal
31	BBEHTC	Pop Noise Reduction for BBE (Process) Control	63	SURTC	Pop Noise Reduction for Surround Control
32	TBTC	Pop Noise Reduction for TruBass ON/OFF	64	TBINT	Capacitor Terminal for TruBass Time Constant

## ■ ABSOLUTE MAXIMUM RATING (Ta=25°C)

PARAMETER	SYMBOL	RATING	UNIT
Supply Voltage	V <sup>+</sup>	15	V
Power Dissipation	P <sub>D</sub>	700*	mW
Operating Temperature Range	Topr	-20 to +75	°C
Storage Temperature Range	Tstg	-40 to +125	°C

\*(Note) EIA/JEDEC STANDARD Test board (76.2 x 114.3 x 1.6mm, 2-Layers, FR-4) mounting

## ■ ELECTRICAL CHARACTERISTICS (Ta=25°C, V<sup>+</sup>=9V, R<sub>g</sub>=600Ω, R<sub>L</sub>=47kΩ, Vin=100mVrms/1kHz, MODE: VOL/BAL/TONE=0dB, SUR/BBE/TB/AGC=OFF unless otherwise specified)

PARAMETER	SYMBOL	TEST CONDITION	MIN.	TYP.	MAX.	UNIT
Operating Voltage	V <sup>+</sup>	-	8.0	9.0	13.0	V
Supply Current	I <sub>CC</sub>	No Signal	-	17	45	mA
Reference Voltage	V <sub>REF</sub>	No Signal	4.0	4.5	5.0	V
Maximum Input Voltage	V <sub>IM</sub>	VOL=-20dB, THD=10%	2.8	3.0	-	Vrms
Maximum Output Voltage	V <sub>OM</sub>	OUTPUT, VOL=0dB, THD=1%	-	2.5	-	Vrms
Channel Balance	G <sub>CB</sub>	VOL=0dB	-1.5	0.0	1.5	dB
Balance Boost A	BA <sub>BST</sub>	CHS="0", BAL=Mute	-2.0	0.0	2.0	dB
Balance Cut A	BA <sub>CUT</sub>	CHS="1", BAL=Mute, Vin=1Vrms	-	-	-70	dB
Balance Boost B	BB <sub>BST</sub>	CHS="1", BAL=Mute	-2.0	0.0	2.0	dB
Balance Cut B	BB <sub>CUT</sub>	CHS="0", BAL=Mute, Vin=1Vrms	-	-	-70	dB
Total Harmonic Distortion	THD	Vo=0.5Vrms BW=400Hz to 30kHz	-	-	0.5	%
Maximum Gain	G <sub>VMAX</sub>	VOL=0dB	-2.0	0.0	2.0	dB
Minimum Gain	G <sub>VMIN</sub>	VOL=Mute	-	-	-70	dB
Line Output Voltage Gain 1	G <sub>VLINE1</sub>	LINEOUT G=0dB, VOL=0dB	-2.0	0.0	2.0	dB
Line Output Voltage Gain 2	G <sub>VLINE2</sub>	LINEOUT G=4.5dB, VOL=0dB	2.5	4.5	6.5	dB
Line Output Voltage Gain 3	G <sub>VLINE3</sub>	LINEOUT G=6dB, VOL=0dB	4.0	6.0	8.0	dB
Channel Separation	CS	Vin=1Vrms	-	-	-70	dB
Output Noise 1	V <sub>NO1</sub>	VOL=0dB BW=400Hz to 30kHz	-	-90 (31.6)	-85 (56.2)	dBV (μVrms)
Output Noise 2	V <sub>NO2</sub>	VOL=Mute BW=400Hz to 30kHz	-	-106 (5.0)	-96 (15.8)	dBV (μVrms)
Output Noise 3	V <sub>NO3</sub>	LINEOUT G=4.5dB, VOL=0dB BW=400Hz to 30kHz	-	-85 (56.2)	-80 (100)	dBV (μVrms)
Output Noise 4	V <sub>NO4</sub>	LINEOUT G=4.5dB, VOL=Mute BW=400Hz to 30kHz	-	-101 (8.9)	-91 (28.2)	dBV (μVrms)

BW: Band Width

■ **ELECTRICAL CHARACTERISTICS** (Ta=25°C, V+=9V, Rg=600Ω, RL=47kΩ, Vin=100mVrms/1kHz, MODE: VOL/BAL/TONE=0dB, SUR/BBE/TB/AGC=OFF unless otherwise specified)

◆ **TONE CONTROL**

PARAMETER	SYMBOL	TEST CONDITION	MIN.	TYP.	MAX.	UNIT
High Frequency Boost	G <sub>HFBST</sub>	TREB=+15dB, f=10kHz	12.5	15.0	17.5	dB
High Frequency Flat	G <sub>HFFLT</sub>	TREB=0dB, f=10kHz	-2.0	0.0	2.0	dB
High Frequency Cut	G <sub>HFCUT</sub>	TREB=-15dB, f=10kHz	-17.5	-15.0	-12.5	dB
Middle Frequency Boost	G <sub>MFBST</sub>	MID=+15dB, f=1kHz	12.5	15.0	17.5	dB
Middle Frequency Flat	G <sub>MFFLT</sub>	MID=0dB, f=1kHz	-2.0	0.0	2.0	dB
Middle Frequency Cut	G <sub>MFCUT</sub>	MID=-15dB, f=1kHz	-17.5	-15.0	-12.5	dB
Low Frequency Boost	G <sub>LFBST</sub>	BASS=+15dB, f=100Hz	12.5	15.0	17.5	dB
Low Frequency Flat	G <sub>LFFLT</sub>	BASS=0dB, f=100Hz	-2.0	0.0	2.0	dB
Low Frequency Cut	G <sub>LF CUT</sub>	BASS=-15dB, f=100Hz	-17.5	-15.0	-12.5	dB

◆ **AGC CHARACTERISTICS (AGC=ON)**

PARAMETER	SYMBOL	TEST CONDITION	MIN.	TYP.	MAX.	UNIT
AGC Boost	G <sub>AGCBST</sub>	Vin=50mVrms, f=1kHz	1.5	3.5	5.5	dB
AGC Flat	G <sub>AGCFLT</sub>	Vin=300mVrms, f=1kHz Rsense=24kΩ	-2.5	0.0	2.5	dB
AGC Cut	G <sub>AGCCUT</sub>	Vin=2Vrms, f=1kHz	-14	-10	-6.0	dB

◆ **BBE CHARACTERISTICS (BBE=ON)**

PARAMETER	SYMBOL	TEST CONDITION	MIN.	TYP.	MAX.	UNIT
Low Boost Gain	G <sub>BBELOW</sub>	BBE-LOW =+15dB, f=50Hz	12.5	15.0	17.5	dB
High Boost Gain	G <sub>BBEHIGH</sub>	BBE-HIGH =+15dB, f=10kHz	12.5	15.0	17.5	dB

◆ **eala CHARACTERISTICS (SUR=ON)**

PARAMETER	SYMBOL	TEST CONDITION	MIN.	TYP.	MAX.	UNIT
Simulated Surround Gain 1	G <sub>SIMA</sub>	INa+INb→OUTa, f=1kHz SUR=MONO	1.0	3.0	5.0	dB
Simulated Surround Gain 2	G <sub>SIMB</sub>	INa+INb→OUTb, f=1kHz SUR=MONO	1.0	3.0	5.0	dB
Surround Gain 1	G <sub>3D1</sub>	INa→OUTa, f=100Hz SUR=ealaLow	1.5	3.5	5.5	dB
Surround Gain 2	G <sub>3D2</sub>	INa→OUTa, f=100Hz SUR=ealaMid	3.5	5.5	7.5	dB
Surround Gain 3	G <sub>3D3</sub>	INa→OUTa, f=100Hz SUR=ealaHigh	8.0	10.0	12.0	dB
Surround Gain 4	G <sub>3D4</sub>	INa→OUTb, f=100Hz SUR=ealaHigh	5.0	7.0	9.0	dB

■ **ELECTRICAL CHARACTERISTICS** (Ta=25°C, V+=9V, Rg=600Ω, RL=47kΩ, Vin=100mVrms/1kHz,  
MODE: VOL/BAL/TONE=0dB, SUR/BBE/TB/AGC=OFF unless otherwise specified)

◆ **TruSurround CHARACTERISTICS (SUR=ON)**

PARAMETER	SYMBOL	TEST CONDITION	MIN.	TYP.	MAX.	UNIT
TruSurround Gain 1	G <sub>TS1</sub>	INa→OUTa, f=1kHz SUR=TS	0.3	2.3	4.3	dB
TruSurround Gain 2	G <sub>TS2</sub>	INa→OUTb, f=1kHz SUR=TS	-13.4	-11.4	-9.4	dB

◆ **SRS 3D CHARACTERISTICS (SUR=ON)**

PARAMETER	SYMBOL	TEST CONDITION	MIN.	TYP.	MAX.	UNIT
Feed Through Gain	G <sub>THROUGH</sub>	INa→OUTa, f=1kHz SPACE1 VR=Min. SPACE2 VR=Max. CENTER VR=Min. SUR=SRS 3D	-20.2	-18.2	-16.2	dB
L+R Gain	G <sub>L+R</sub>	INa→OUTb, f=1kHz SPACE1 VR=Min. SPACE2 VR=Max. CENTER VR=Max. SUR=SRS 3D	-15.0	-13.0	-11.0	dB
L-R Gain	G <sub>L-R</sub>	INa→OUTa, f=125Hz SPACE1 VR=Max. SPACE2 VR=Max. CENTER VR=Min. SUR=SRS 3D	-2.0	0.0	2.0	dB

◆ **TruBass CHARACTERISTICS (TB=ON, f<sub>0</sub>=60Hz setting)**

PARAMETER	SYMBOL	TEST CONDITION	MIN.	TYP.	MAX.	UNIT
TruBass Gain 1	G <sub>TB1</sub>	INa+INb→OUTa, f=60Hz TB VR=∞	4.0	6.0	8.0	dB
TruBass Gain 2	G <sub>TB2</sub>	INa+INb→OUTb, f=60Hz TB VR=0Ω	16.0	18.0	20.0	dB
TruBass Gain 3	G <sub>TB3</sub>	INa+INb→OUTa, f=60Hz TB VR=∞, V <sub>IN</sub> =1Vrms	-2.0	0.0	2.0	dB
TruBass Gain 4	G <sub>TB4</sub>	INa-INb→OUTa, f=120Hz TB VR=0Ω, V <sub>IN</sub> =1Vrms	-5.0	-3.0	-1.0	dB
TruBass Gain 5	G <sub>TB5</sub>	INa-INb→OUTb, f=120Hz TB VR=0Ω, V <sub>IN</sub> =2Vrms	-5.0	-3.0	-1.0	dB

## ■ I<sup>2</sup>C BUS CHARACTERISTICS (SDA, SCL)

I<sup>2</sup>C BUS Load Conditions: Pull up resistance 4kΩ (Connected to +5V), Load capacitance 200pF (Connected to GND)

PARAMETER	SYMBOL	Standard mode			Fast mode			UNIT
		MIN.	TYP.	MAX.	MIN.	TYP.	MAX.	
Low Level Input Voltage	V <sub>IL</sub>	0.0	-	1.5	0.0	-	1.5	V
High Level Input Voltage	V <sub>IH</sub>	2.7	-	5.0	2.7	-	5.0	V
Hysteresis of Schmitt trigger inputs	V <sub>hys</sub>	-	-	-	0.25	-	-	V
Low level output voltage (3mA at SDA pin)	V <sub>OL</sub>	0	-	0.4	0	-	0.4	V
Output fall time from V <sub>IHmin</sub> to V <sub>ILmax</sub> with a bus capacitance from 10pF to 400pF	t <sub>of</sub>	-	-	250	20 +0.1C <sub>b</sub>	-	250	ns
Pulse width of spikes which must be suppressed by the input filter	t <sub>SP</sub>	-	-	-	0	-	50	ns
Input current each I/O pin with an input voltage between 0.1V <sub>DD</sub> and 0.9V <sub>DDmax</sub>	I <sub>i</sub>	-10	-	10	-10	-	10	μA
Capacitance for each I/O pin	C <sub>i</sub>	-	-	10	-	-	10	pF
SCL clock frequency	f <sub>SCL</sub>	-	-	100	-	-	400	kHz
Hold time (repeated) START condition.	t <sub>HD:STA</sub>	4.0	-	-	0.6	-	-	μs
Low period of the SCL clock	t <sub>LOW</sub>	4.7	-	-	1.3	-	-	μs
High period of the SCL clock	t <sub>HIGH</sub>	4.0	-	-	0.6	-	-	μs
Set-up time for a repeated START condition	t <sub>SU:STA</sub>	4.7	-	-	0.6	-	-	μs
Data hold time	t <sub>HD:DAT</sub>	0	-	3.45	0	-	0.9	μs
Data set-up time	t <sub>SU:DAT</sub>	250	-	-	100	-	-	ns
Rise time of both SDA and SCL signals	t <sub>r</sub>	-	-	1000	-	-	300	ns
Fall time of both SDA and SCL signals	t <sub>f</sub>	-	-	300	-	-	300	ns
Set-up time for STOP condition	t <sub>SU:STO</sub>	4.0	-	-	0.6	-	-	μs
Bus free time between a STOP and START condition	t <sub>BUF</sub>	4.7	-	-	1.3	-	-	μs
Capacitive load for each bus line	C <sub>b</sub>	-	-	400	-	-	400	pF
Noise margin at the Low level	V <sub>nL</sub>	0.5	-	-	0.5	-	-	V
Noise margin at the High level	V <sub>nH</sub>	1	-	-	1	-	-	V

C<sub>b</sub>: total capacitance of one bus line in pF.

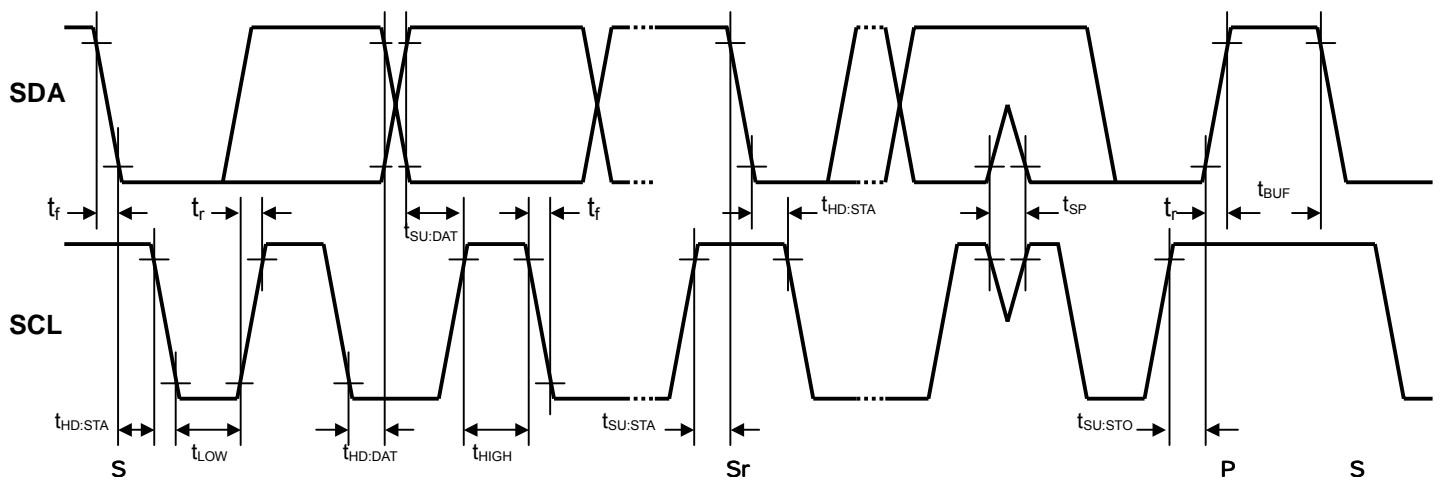

## ■ TERMINAL DESCRIPTION

No.	SYMBOL	FUNCTION	EQUIVALENT CIRCUIT	VOLTAGE
1 48	HPF1a HPF1b	Ach HPF for TruBass Capacitor 1 Bch HPF for TruBass Capacitor 1		V+/2
2 47	HPF2a HPF2b	Ach HPF for TruBass Capacitor 2 Bch HPF for TruBass Capacitor 2		V+/2
3 46	HPF3a HPF3b	Ach HPF for TruBass Capacitor 3 Bch HPF for TruBass Capacitor 3		V+/2
4 5 6	TS1 TS2 TS3	TruSurround Filter Capacitor 1 TruSurround Filter Capacitor 2 TruSurround Filter Capacitor 3		V+/2

## ■ TERMINAL DESCRIPTION

No.	SYMBOL	FUNCTION	EQUIVALENT CIRCUIT	VOLTAGE
7	VREFOUT	Reference Voltage Output		V+/2
8 41 9 40	BBE-La BBE-Lb BBE-Ha BBE-Hb	Ach BBE Filter (Lo Contour) Bch BBE Filter (Lo Contour) Ach BBE Filter (Process) Bch BBE Filter (Process)		V+/2
10 39	TONE-Ha TONE-Hb	Ach Tone (Treble) Filter Bch Tone (Treble) Filter		V+/2
11 38	TONE-M1a TONE-M1b	Ach Tone (Middle) Filter 1 Bch Tone (Middle) Filter 1		V+/2



## ■ TERMINAL DESCRIPTION

No.	SYMBOL	FUNCTION	EQUIVALENT CIRCUIT	VOLTAGE
12 37	TONE-M2a TONE-M2b	Ach Tone (Middle) Filter 2 Ach Tone (Middle) Filter 2		V+/2
13 36	TONE-La TONE-Lb	Ach Tone (Bass) Filter Ach Tone (Bass) Filter		V+/2
14 35	INa INb	Ach Input Bch Input		V+/2
15 34 16 33 17	LINEOUTa LINEOUTb OUTa OUTb Bass/Center OUT	Ach Lineout (0/4.5/6.0/Mute) Bch Lineout (0/4.5/6.0/Mute) Ach Output (0dB) Bch Output (0dB) Bass/Center Output		V+/2

## ■ TERMINAL DESCRIPTION

No.	SYMBOL	FUNCTION	EQUIVALENT CIRCUIT	VOLTAGE
18	AGCSENSE	AGC Boost Level Setting Terminal		0V
19	AGCINT	AGC Attack & Recovery Time Setting Terminal		1.4V
20 21	VOLATC VOLBTC	Pop Noise Reduction for Ach Volume Control Pop Noise Reduction for Bch Volume Control		Vref-0.7V (VOL=BAL=0dB)
22 23	SDA SCL	I <sup>2</sup> C Data Input I <sup>2</sup> C Clock Input		-

## ■ TERMINAL DESCRIPTION

No.	SYMBOL	FUNCTION	EQUIVALENT CIRCUIT	VOLTAGE
24	GND	Ground	-	-
25	V+	Power Supply	-	-
26	VREFIN	Reference Voltage Stabilizing Capacitor		$V+/2$
27	OUTTC	Pop Noise Reduction for Lineout Gain Setting		0V (OUT-Mute)

## ■ TERMINAL DESCRIPTION

No.	SYMBOL	FUNCTION	EQUIVALENT CIRCUIT	VOLTAGE
28 29 30	TONELTC TONEMTC TONEHTC	Pop Noise Reduction for Tone (Bass) Control Pop Noise Reduction for Tone (Middle) Control Pop Noise Reduction for Tone (Treble) Control		Vref-0.7V (Tone=FLAT)
31	BBEHTC	Pop Noise Reduction for BBE (Process) Control		Vref-0.2V (BBE=OFF)
32	TBTC	Pop Noise Reduction for TruBass ON/OFF		0V (TB=OFF)
49	ealaFil	eala Filter Capacitor		V+/2

## ■ TERMINAL DESCRIPTION

No.	SYMBOL	FUNCTION	EQUIVALENT CIRCUIT	VOLTAGE
50	CENTER	SRS CENTER Effect Control Terminal		V+/2
51	SPACE1	SRS SPACE Effect Control Terminal 1		V+/2
52	SPACE2	SRS SPACE Filter		V+/2
53 55 57	BPF3OUT BPF2OUT BPF1OUT	BPF Output for TruBass Terminal 3 BPF Output for TruBass Terminal 2 BPF Output for TruBass Terminal 1		V+/2

## ■ TERMINAL DESCRIPTION

No.	SYMBOL	FUNCTION	EQUIVALENT CIRCUIT	VOLTAGE
54	BPF3IN	BPF Input for TruBass Terminal 3		V+/2
56	BPF2IN	BPF Input for TruBass Terminal 2		
58	BPF1IN	BPF Input for TruBass Terminal 1		
59	LPFOUT	LPF Output for TruBass		V+/2
60	LPF2	LPF for TruBass Capacitor Terminal 2		V+/2
61	LPF1	LPF for TruBass Capacitor Terminal 1		
62	TBCONT	TruBass Punch Control Terminal		V+/2

## ■ TERMINAL DESCRIPTION

No.	SYMBOL	FUNCTION	EQUIVALENT CIRCUIT	VOLTAGE
63	SURTC	Pop Noise Reduction for Surround Control		1.4V (SUR=OFF)
64	TBINT	Capacitor Terminal for TruBass Time Constant		0V (TB=OFF)

# NJW1169

## APPLICATION CIRCUIT

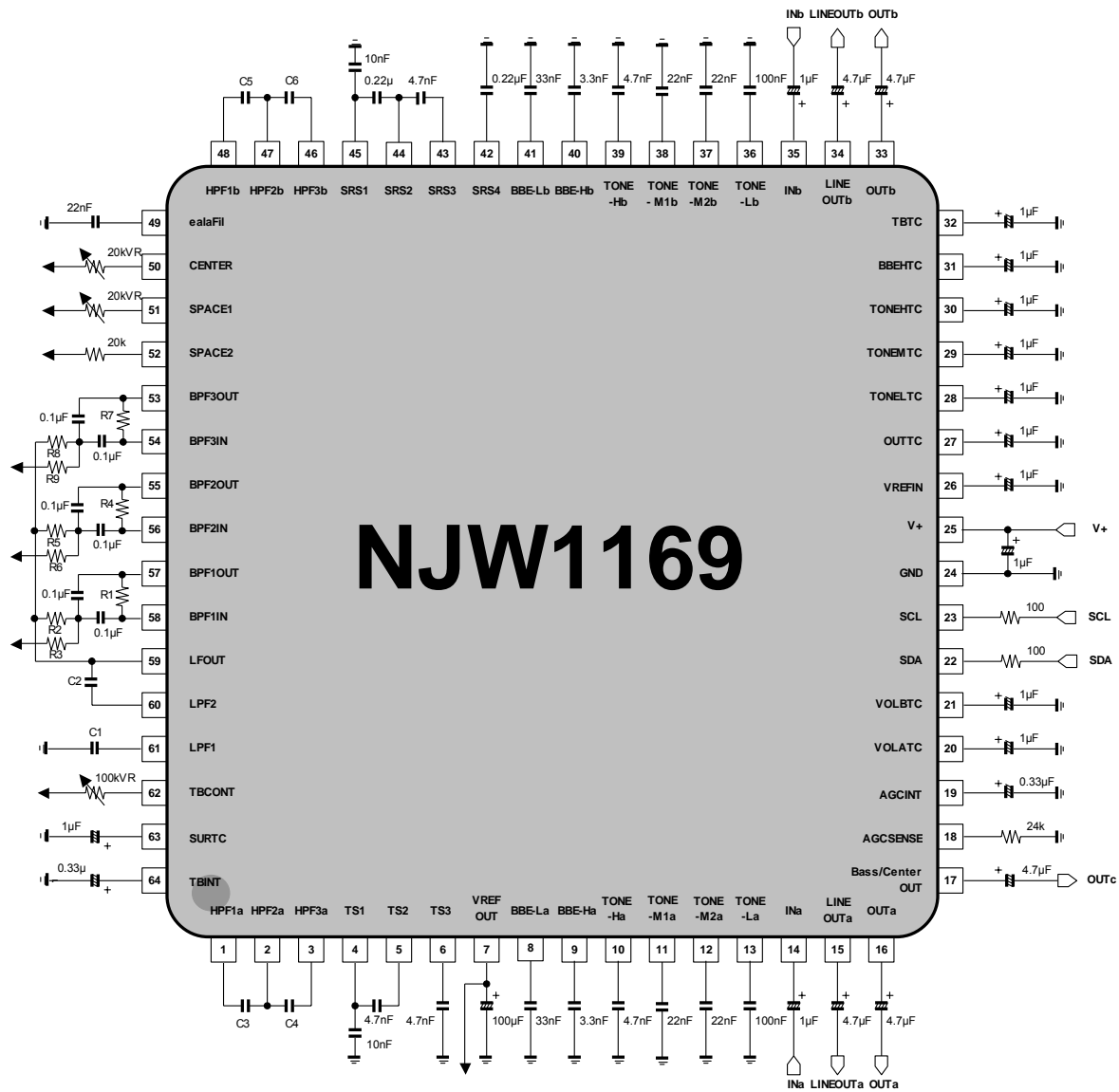

TruBass Speaker Size f <sub>0</sub> Setting	Resistance Value [kΩ]									Capacitance Value [nF]					
	R1	R2	R3	R4	R5	R6	R7	R8	R9	C1	C2	C3	C4	C5	C6
40Hz	78.7	20	6.65	107	26.7	8.87	158	40.2	13.3	270	270	33	33	33	33
60Hz	53.6	13.3	4.42	71.5	17.8	5.9	107	26.7	8.87	180	180	22	22	22	22
100Hz	31.6	7.87	2.67	42.2	10.7	3.57	63.4	15.8	5.36	100	100	12	12	12	12
150Hz	21	5.36	1.78	28	7.15	2.37	42.2	10.7	3.57	68	68	8.2	8.2	8.2	8.2
200Hz	15.8	4.02	1.33	21	5.36	1.78	31.6	7.87	2.67	56	56	6.8	6.8	6.8	6.8
250Hz	12.7	3.16	1.07	16.9	4.22	1.4	25.5	6.34	2.1	39	39	5.6	5.6	5.6	5.6
300Hz	12.7	3.16	1.07	15.8	4.02	1.33	21	5.36	1.78	39	39	4.7	4.7	4.7	4.7
400Hz	10.7	2.67	0.887	12.7	3.16	1.07	15.8	4.02	1.33	33	33	3.9	3.9	3.9	3.9

\*) The standard TruBass speaker size setting is as aforementioned.  
Set the speaker size setting by TruBass effect of your application.



NOTE1) Separate the I<sup>2</sup>C bus line from the following terminals for avoiding digital noise problem.  
 Especially, the terminals for BBE filter (No.8, 9, 40 and 41) and Tone filter (No.10 to 13 and 36 to 39) are easily influenced.

Pin No.	Symbol	Pin No.	Symbol	Pin No.	Symbol	Pin No.	Symbol	Pin No.	Symbol
1	HPF1a	10	Tone-Ha	40	BBE-Hb	48	HPF1b	56	BPF2IN
2	HPF2a	11	Tone-M1a	41	BBE-Lb	49	ealaFIL	57	BPF1OUT
3	HPF3a	12	Tone-M2a	42	SRS4	50	CENTER	58	BPF1IN
4	TS1	13	Tone-La	43	SRS3	51	SPACE1	59	LPFOUT
5	TS2	36	Tone-Lb	44	SRS2	52	SPACE2	60	LPF2
6	TS3	37	Tone-M2b	45	SRS1	53	BPF3OUT	61	LPF1
8	BBE-La	38	Tone-M1b	46	HPF3b	54	BPF3IN	62	TBCONT
9	BBE-Ha	39	Tone-Hb	47	HPF2b	55	BPF2OUT	-	-

NOTE 2) The constant of capacitors connected to the terminals No.8, 9, 40 and 41 are designated by BBE Sound Inc.  
 Do not change the constant of these capacitors without the approval of BBE Sound Inc.

NOTE 3) The constant of capacitors and resistors connected to the terminals No.1 to 6, 42 to 48, 53 to 62 and 64 are  
 designated by SRS Labs Inc. Do not change the constant of these parts without the approval of SRS Labs Inc.

## ■ DEFINITION OF I<sup>2</sup>C REGISTER

### ● I<sup>2</sup>C BUS FORMAT

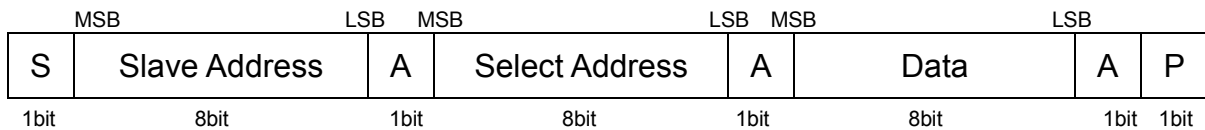

S: Starting Term

A: Acknowledge Bit

P: Ending Term

### ● SLAVE ADDRESS



$\overline{R/W}$ =0: Write mode for register setting

$\overline{R/W}$ =1: Not available

### ● CONTROL REGISTER TABLE

The select address sets each function (Volume, Balance, AGC, Tone Control, Surround etc.).

The auto-increment function cycles the select address as follows.

00H→01H→02H→03H→04H→05H→06H→00H

Select Address	BIT							
	D7	D6	D5	D4	D3	D2	D1	D0
00H	VOL							
01H	CHS	BAL				Don't Care		
02H	BCB	BASS				TB	Don't Care	
03H	BCM	MID				AGC	OUT	
04H	BCT	TREB				LINEOUT		
05H	BBEL				BBE	BASS/CENTER-OUT		
06H	BBEH				SUR			

### ● CONTROL REGISTER DEFAULT VALUE

Control register default value is all "0".

Select Address	BIT							
	D7	D6	D5	D4	D3	D2	D1	D0
00H	0	0	0	0	0	0	0	0
01H	0	0	0	0	0	0	0	0
02H	0	0	0	0	0	0	0	0
03H	0	0	0	0	0	0	0	0
04H	0	0	0	0	0	0	0	0
05H	0	0	0	0	0	0	0	0
06H	0	0	0	0	0	0	0	0

## ■ I<sup>2</sup>C CONTROL COMMAND DESCRIPTION

### a) MASTER VOLUME CONTROL

Select Address	BIT							
	D7	D6	D5	D4	D3	D2	D1	D0
00H	VOL							

- VOL: Master Volume Control  
Attenuation Level: 0 to -80dB(0.33dB/step), MUTE  
The volume is consisted of volume1 and volume2. The level is divided into half to each volume1 and volume2.

### b) BALANCE SETTINGS

Select Address	BIT							
	D7	D6	D5	D4	D3	D2	D1	D0
01H	CHS	BAL					Don't Care	

- CHS: Channel Select for Balance Control  
"0": Ach "Bch is attenuated"  
"1": Bch "Ach is attenuated"
- BAL: Balance Level Setting  
Balance Level: 0 to -30(1dB/step), MUTE

### c) TONE CONTROL (Bass) and TruBass ON/OFF SETTINGS

Select Address	BIT							
	D7	D6	D5	D4	D3	D2	D1	D0
02H	BCB	BASS					TB	Don't Care

- BCB: Boost or Cut Select for Tone Control (Bass)  
"0": Cut  
"1": Boost
- BASS: Bass Boost or Cut Level  
Cut Level : -15 to 0dB(1dB/step)  
Boost Level : 0 to +15dB(1dB/step)
- TB: TruBass ON/OFF Setting  
"0": OFF  
"1": ON

### c) TONE CONTROL (Middle), AGC ON/OFF and OUT Switch ON/OFF SETTINGS

Select Address	BIT							
	D7	D6	D5	D4	D3	D2	D1	D0
03H	BCM	MID					AGC	OUT

- BCM: Boost or Cut Select for Tone Control (Middle)  
"0": Cut  
"1": Boost
- MID: Middle Boost or Cut Level  
Cut Level : -15 to 0dB(1dB/step)  
Boost Level : 0 to +15dB(1dB/step)
- AGC: AGC ON/OFF Setting  
"0": OFF  
"1": ON
- OUT: No.16 and 33 Pin Out Switch Setting  
"0": OFF  
"1": ON

## e) TONE CONTROL (Treble) and LINEOUT GAIN SETTINGS

Select Address	BIT							
	D7	D6	D5	D4	D3	D2	D1	D0
04H	BCT	TREB					LINEOUT	

- BCT: Boost or Cut Select for Tone Control (Treble)  
 "0": Cut  
 "1": Boost
- TREB: Treble Boost or Cut Level  
 Cut Level : -15 to 0dB(1dB/step)  
 Boost Level : 0 to +15dB(1dB/step)
- LINEOUT: Lineout(No.15 and 34 pin out) Gain Setting  
 Gain Setting: 0dB, 4.5dB, 6dB, OFF  
 (NOTE) The click noise may be generated by changing the LINEOUT Gain setting.  
 Provide the external circuit for preventing the click noise on above condition.

## f) BBE-Low, BASS/CENTER OUT SETTINGS

Select Address	BIT							
	D7	D6	D5	D4	D3	D2	D1	D0
05H	BBEL					BBE	BASS/CENTER-OUT	

- BBEL: BBE-LOW Level Setting  
 BBE Low Level (Lo Contour): 0dB to 15dB(0.5dB/step)  
 (NOTE) The click noise may be generated by changing the BBE Low Level setting.  
 The click noise problem may be prevented the following process.  
 BBE OFF → BBE-Low Level Setting → BBE ON
- BBE: BBE ON/OFF Setting  
 "0": OFF  
 "1": ON
- BASS/CENTER-OUT: No.17 Pin Out Setting  
 Output Mode: OFF, Center Out (at TS mode), TB Effect Out (at TruBass mode)

## g) BBE-High, SURROUND SETTINGS

Select Address	BIT							
	D7	D6	D5	D4	D3	D2	D1	D0
06H	BBEH					SUR		

- BBEH: BBE-HIGH Level Setting  
 BBE High Level (Process): 0dB to 15dB(0.5dB/step)
- SUR: Surround Mode Setting  
 Mode: Bypass, MONO, SRS 3D, TS, eala-Low/Mid/High

■ MASTER VOLUME SETTING (Select Address: 00H)

		VOL							
Gain (dB)	HEX	D7	D6	D5	D4	D3	D2	D1	D0
0	FF	1	1	1	1	1	1	1	1
-1	FC	1	1	1	1	1	1	0	0
-2	F9	1	1	1	1	1	0	0	1
-3	F6	1	1	1	1	0	1	1	0
-4	F3	1	1	1	1	0	0	1	1
-5	F0	1	1	1	1	0	0	0	0
-6	ED	1	1	1	0	1	1	0	1
-7	EA	1	1	1	0	1	0	1	0
-8	E7	1	1	1	0	0	1	1	1
-9	E4	1	1	1	0	0	1	0	0
-10	E1	1	1	1	0	0	0	0	1
-11	DE	1	1	0	1	1	1	1	0
-12	DB	1	1	0	1	1	0	1	1
-13	D8	1	1	0	1	1	0	0	0
-14	D5	1	1	0	1	0	1	0	1
-15	D2	1	1	0	1	0	0	1	0
-16	CF	1	1	0	0	1	1	1	1
-17	CC	1	1	0	0	1	1	0	0
-18	C9	1	1	0	0	1	0	0	1
-19	C6	1	1	0	0	0	1	1	0
-20	C3	1	1	0	0	0	0	1	1
-21	C0	1	1	0	0	0	0	0	0
-22	BD	1	0	1	1	1	1	0	1
-23	BA	1	0	1	1	1	0	1	0
-24	B7	1	0	1	1	0	1	1	1
-25	B4	1	0	1	1	0	1	0	0
-26	B1	1	0	1	1	0	0	0	1
-27	AE	1	0	1	0	1	1	1	0
-28	AB	1	0	1	0	1	0	1	1
-29	A8	1	0	1	0	1	0	0	0
-30	A5	1	0	1	0	0	1	0	1
-31	A2	1	0	1	0	0	0	1	0
-32	9F	1	0	0	1	1	1	1	1
-33	9C	1	0	0	1	1	1	0	0
-34	99	1	0	0	1	1	0	0	1
-35	96	1	0	0	1	0	1	1	0
-36	93	1	0	0	1	0	0	1	1
-37	90	1	0	0	1	0	0	0	0
-38	8D	1	0	0	0	1	1	0	1
-39	8A	1	0	0	0	1	0	1	0
-40	87	1	0	0	0	0	1	1	1
-41	84	1	0	0	0	0	1	0	0
-42	81	1	0	0	0	0	0	0	1

## ■MASTER VOLUME SETTING (Cont'd)

		VOL							
Gain (dB)	HEX	D7	D6	D5	D4	D3	D2	D1	D0
-43	7E	0	1	1	1	1	1	1	0
-44	7B	0	1	1	1	1	0	1	1
-45	78	0	1	1	1	1	0	0	0
-46	75	0	1	1	1	0	1	0	1
-47	72	0	1	1	1	0	0	1	0
-48	6F	0	1	1	0	1	1	1	1
-49	6C	0	1	1	0	1	1	0	0
-50	69	0	1	1	0	1	0	0	1
-51	66	0	1	1	0	0	1	1	0
-52	63	0	1	1	0	0	0	1	1
-53	60	0	1	1	0	0	0	0	0
-54	5D	0	1	0	1	1	1	0	1
-55	5A	0	1	0	1	1	0	1	0
-56	57	0	1	0	1	0	1	1	1
-57	54	0	1	0	1	0	1	0	0
-58	51	0	1	0	1	0	0	0	1
-59	4E	0	1	0	0	1	1	1	0
-60	4B	0	1	0	0	1	0	1	1
-61	48	0	1	0	0	1	0	0	0
-62	45	0	1	0	0	0	1	0	1
-63	42	0	1	0	0	0	0	1	0
-64	3F	0	0	1	1	1	1	1	1
-65	3C	0	0	1	1	1	1	0	0
-66	39	0	0	1	1	1	0	0	1
-67	36	0	0	1	1	0	1	1	0
-68	33	0	0	1	1	0	0	1	1
-69	30	0	0	1	1	0	0	0	0
-70	2D	0	0	1	0	1	1	0	1
-71	2A	0	0	1	0	1	0	1	0
-72	27	0	0	1	0	0	1	1	1
-73	24	0	0	1	0	0	1	0	0
-74	21	0	0	1	0	0	0	0	1
-75	1E	0	0	0	1	1	1	1	0
-76	1B	0	0	0	1	1	0	1	1
-77	18	0	0	0	1	1	0	0	0
-78	15	0	0	0	1	0	1	0	1
-79	12	0	0	0	1	0	0	1	0
-80	0F	0	0	0	0	1	1	1	1
Mute	00	0	0	0	0	0	0	0	0

■ **BALANCE SETTING (Select Address: 01H)**

Channel Select	CHS
	<b>D7</b>
Ach (Bch is attenuated)	0
Bch (Ach is attenuated)	1

Gain(dB)	BAL				
	D6	D5	D4	D3	D2
0	0	0	0	0	0
-1	0	0	0	0	1
-2	0	0	0	1	0
-3	0	0	0	1	1
-4	0	0	1	0	0
-5	0	0	1	0	1
-6	0	0	1	1	0
-7	0	0	1	1	1
-8	0	1	0	0	0
-9	0	1	0	0	1
-10	0	1	0	1	0
-11	0	1	0	1	1
-12	0	1	1	0	0
-13	0	1	1	0	1
-14	0	1	1	1	0
-15	0	1	1	1	1
-16	1	0	0	0	0
-17	1	0	0	0	1
-18	1	0	0	1	0
-19	1	0	0	1	1
-20	1	0	1	0	0
-21	1	0	1	0	1
-22	1	0	1	1	0
-23	1	0	1	1	1
-24	1	1	0	0	0
-25	1	1	0	0	1
-26	1	1	0	1	0
-27	1	1	0	1	1
-28	1	1	1	0	0
-29	1	1	1	0	1
-30	1	1	1	1	0
MUTE	1	1	1	1	1

## ■ TONE CONTROL BASS SETTINGS (Select Address: 02H)

Bass	BCB
Cut or Boost	D7
Cut	0
Boost	1

		BASS				
Cut Gain(dB)	Boost Gain(dB)	D6	D5	D4	D3	D2
-15	15	1	1	1	1	0
-14	14	1	1	1	0	0
-13	13	1	1	0	1	0
-12	12	1	1	0	0	0
-11	11	1	0	1	1	0
-10	10	1	0	1	0	0
-9	9	1	0	0	1	0
-8	8	1	0	0	0	0
-7	7	0	1	1	1	0
-6	6	0	1	1	0	0
-5	5	0	1	0	1	0
-4	4	0	1	0	0	0
-3	3	0	0	1	1	0
-2	2	0	0	1	0	0
-1	1	0	0	0	1	0
0	0	0	0	0	0	0

## ■ TONE CONTROL MIDDLE SETTINGS (Select Address: 03H)

Middle	BCM
Cut or Boost	D7
Cut	0
Boost	1

		MID				
Cut Gain(dB)	Boost Gain(dB)	D6	D5	D4	D3	D2
-15	15	1	1	1	1	0
-14	14	1	1	1	0	0
-13	13	1	1	0	1	0
-12	12	1	1	0	0	0
-11	11	1	0	1	1	0
-10	10	1	0	1	0	0
-9	9	1	0	0	1	0
-8	8	1	0	0	0	0
-7	7	0	1	1	1	0
-6	6	0	1	1	0	0
-5	5	0	1	0	1	0
-4	4	0	1	0	0	0
-3	3	0	0	1	1	0
-2	2	0	0	1	0	0
-1	1	0	0	0	1	0
0	0	0	0	0	0	0



## ■ TONE CONTROL TREBLE SETTINGS (Select Address: 04H)

Treble Cut or Boost	BCT D7
Cut	0
Boost	1

		TREB				
Cut Gain(dB)	Boost Gain(dB)	D6	D5	D4	D3	D2
-15	15	1	1	1	1	0
-14	14	1	1	1	0	0
-13	13	1	1	0	1	0
-12	12	1	1	0	0	0
-11	11	1	0	1	1	0
-10	10	1	0	1	0	0
-9	9	1	0	0	1	0
-8	8	1	0	0	0	0
-7	7	0	1	1	1	0
-6	6	0	1	1	0	0
-5	5	0	1	0	1	0
-4	4	0	1	0	0	0
-3	3	0	0	1	1	0
-2	2	0	0	1	0	0
-1	1	0	0	0	1	0
0	0	0	0	0	0	0

■BBE ON/OFF SETTING (Select Address: 05H)

BBE ON/OFF	BBE
	D2
OFF	0
ON	1

■BBE-LOW (Lo Contour) GAIN SETTING (Select Address: 05H)

Gain(dB)	BBEL				
	D7	D6	D5	D4	D3
15	1	1	1	1	0
14	1	1	1	0	0
13	1	1	0	1	0
12	1	1	0	0	0
11	1	0	1	1	0
10	1	0	1	0	0
9	1	0	0	1	0
8	1	0	0	0	0
7	0	1	1	1	0
6	0	1	1	0	0
5	0	1	0	1	0
4	0	1	0	0	0
3	0	0	1	1	0
2	0	0	1	0	0
1	0	0	0	1	0
0	0	0	0	0	0

■BBE-HIGH (Process) GAIN SETTING (Select Address: 06H)

Gain(dB)	BBEH				
	D7	D6	D5	D4	D3
15	1	1	1	1	0
14	1	1	1	0	0
13	1	1	0	1	0
12	1	1	0	0	0
11	1	0	1	1	0
10	1	0	1	0	0
9	1	0	0	1	0
8	1	0	0	0	0
7	0	1	1	1	0
6	0	1	1	0	0
5	0	1	0	1	0
4	0	1	0	0	0
3	0	0	1	1	0
2	0	0	1	0	0
1	0	0	0	1	0
0	0	0	0	0	0

## ■ TruBass ON/OFF SETTING (Select Address: 02H)

TruBass	TB
	D1
OFF	0
ON	1

## ■ AGC ON/OFF SETTING (Select Address: 03H)

AGC	AGC
	D1
OFF	0
ON	1

## ■ OUTPUT SWITCH SETTING (Select Address: 03H)

Output	OUT
	D0
OFF	0
ON	1

## ■ LINEOUT GAIN SETTING (Select Address: 04H)

Gain	LINEOUT	
	D1	D0
OFF	0	0
0dB	0	1
4.5dB	1	0
6dB	1	1

## ■ BASS/CENTER-OUT SETTING (Select Address: 05H)

Output Mode	BASS/CENTER-OUT	
	D1	D0
OFF	0	0
	1	0
Center Out	0	1
TB Effect Out	1	1

## ■ SURROUND MODE SETTING (Select Address: 06H)

Mode	SUR		
	D2	D1	D0
Bypass	0	0	0
eala Low	0	0	1
eala Mid	0	1	0
eala High	0	1	1
TS	1	0	1
SRS 3D	1	1	0
MONO	1	1	1

■ NOTE

- 1) The **NJW1169** is manufactured by New Japan Radio Co., Ltd. under license from BBE Sound Inc. BBE is a registered trademark of BBE Sound Inc. A license from BBE Sound Inc. must be required before the **NJW1169** can be purchased from New Japan Radio Co., Ltd.

BBE Sound, Inc.  
5381 Production Drive  
Huntington Beach, CA 92649 USA  
Tel: (714) 897-6766 Fax: (714) 896-0736

- 2) The SRS technology right incorporated in the **NJW1169** is owned by SRS Labs, a U.S. Corporation and licensed to New Japan Radio Co., Ltd. SRS is protected under U.S. and foreign patents issued and/or pending. SRS and the , are trademarks of SRS Labs, Inc. in the United States and selected foreign countries. Neither the purchase of the **NJW1169**, nor the corresponding sale of audio enhancement equipment conveys the right to sell commercialized recording made with any SRS technology.

SRS Labs requires that all users of the **NJW1169** must enter into a license agreement directly with SRS Labs if the royalty is not included in the purchase price. SRS Labs also requires any users to comply with all rules and regulations as outlined in the SRS Trademark Usage Manual.

For further information, please contact:  
SRS Labs, Inc.  
2909 Daimler Street, Santa Ana, CA 92705 USA  
Tel: (949) 442-1070 Fax: (949) 852-1099 [www.srslabs.com](http://www.srslabs.com)

[CAUTION]

The specifications on this databook are only given for information, without any guarantee as regards either mistakes or omissions. The application circuits in this databook are described only to show representative usages of the product and not intended for the guarantee or permission of any right including the industrial rights.