

Simple Graphic Equaliser

Take the bumps out of your audio system with our simple Graphic Equaliser.

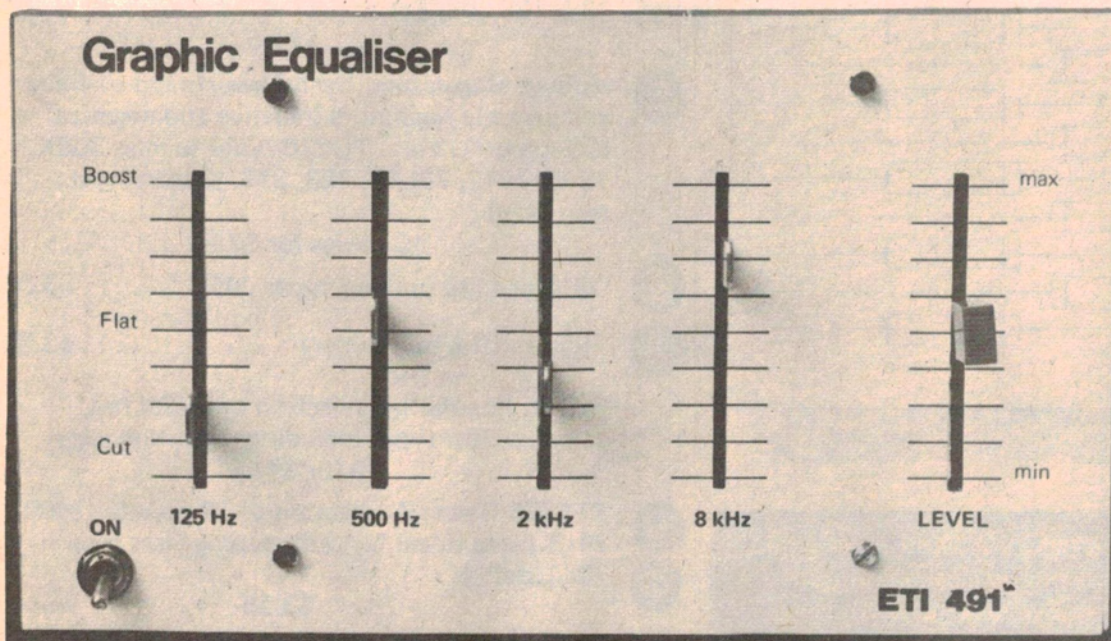

A GRAPHIC WHAT, you ask? A graphic equaliser is a complex form of tone control. It can be used to smooth out the frequency response of a hi-fi, or as a guitar effects unit. In fact, it will prove useful in any audio application.

Frequency Response

In order to explain how the equaliser works, here is a quick explanation of the term 'frequency response'.

Say we take a circuit and set it up like this:

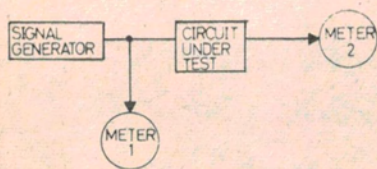

The ratio of the reading of meter 1 to the reading of meter 2 is called the response of the circuit. If the generator frequency is varied, the output reading on meter 2 varies because the circuit behaves differently when fed with different frequencies. If this ratio of input to output voltage is plotted against frequency, the resulting graph is called a Frequency Response Curve.

The frequency response of a typical amplifier looks something like this:

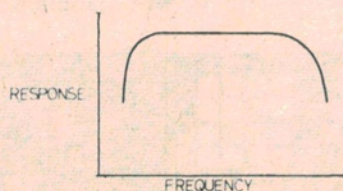

The central section of the curve is fairly 'flat' but when it comes to the very high or very low frequencies it rolls off as the circuit under test finds it difficult to maintain its output at these frequencies, reducing the reading on meter 2.

Once the signal from the amplifier has been passed to the speaker (which has its own frequency response as well), the response of the system overall may look like this:

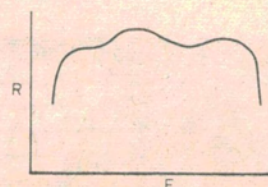

This will be further modified by the response of the room where the hi-fi is — even your curtains have a response curve! By the time the signal finally reaches your ears the overall response will be fairly well mangled.

An equaliser is a device for correcting (equalising) the frequency response of a system.

Ironing out the Bumps

Say, for instance, that the frequency response looked like this when it reached you (rather exaggerated, perhaps!):

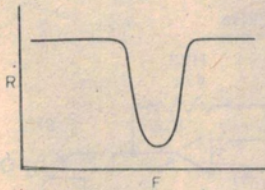

and we would of course like it to look like this:

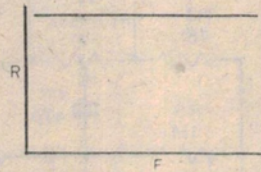

If we have a device (called an equaliser) which has a response like this (the opposite to the one we wish to correct):

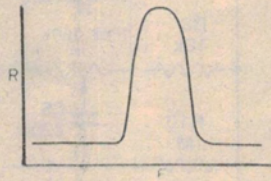

and we put it in series with the system, the overall response would be the sum of the two responses:

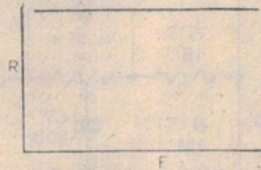

In this way we can take any system, be it a microphone, a telephone line or a

hi-fi system, and iron out the variations in its response.

There are two ways of finding the correct equaliser settings. One is to measure the system response curve and design a custom equaliser to correct it. This is fine if you are prepared to do all the sums and build a complete new unit for each different application. The other is to build a device which has a variable response which can be adjusted to give the desired effect.

The way this is usually done is to build a unit which will split the incoming signal into a number of frequency bands and then remix these in the desired ratios. This will give the device a number of plateaux on its response curve, all of which can be moved up or down independently of each other to give an approximation to the desired shape.

An equaliser of this type is called a graphic equaliser if the controls which determine the positions of the plateaux are of the 'slider' type. The positions of the control knobs will then look like the frequency response graph of the equaliser.

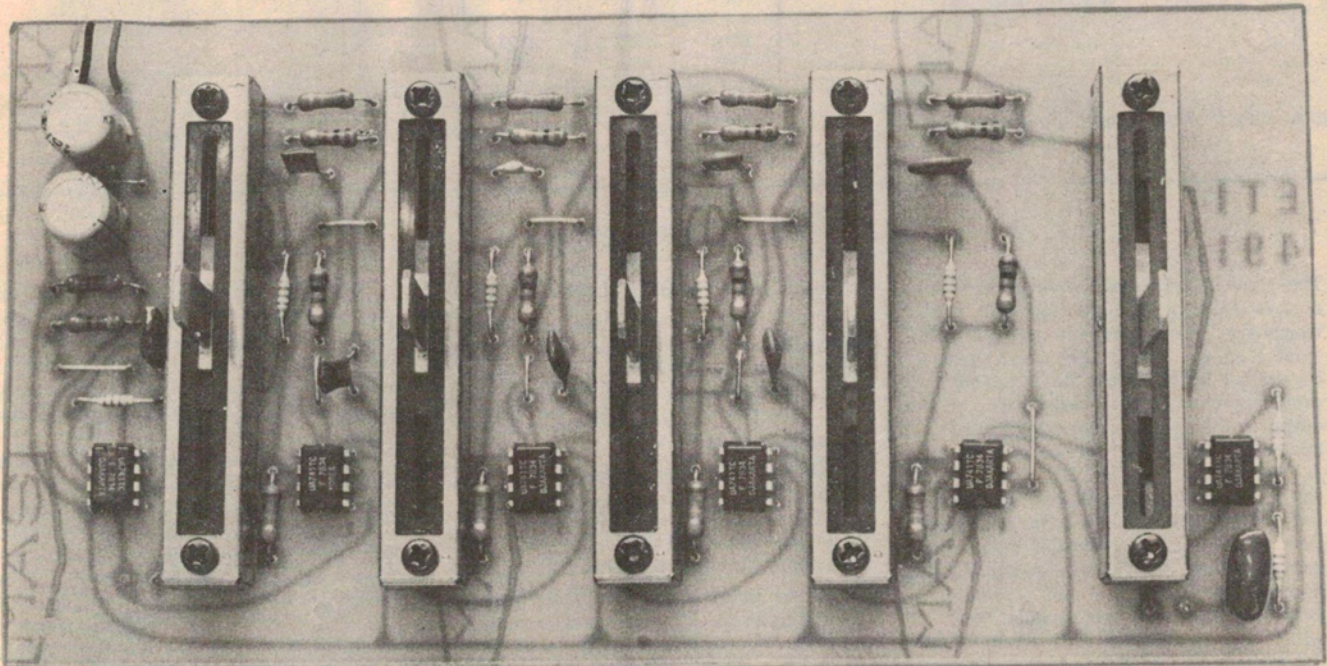

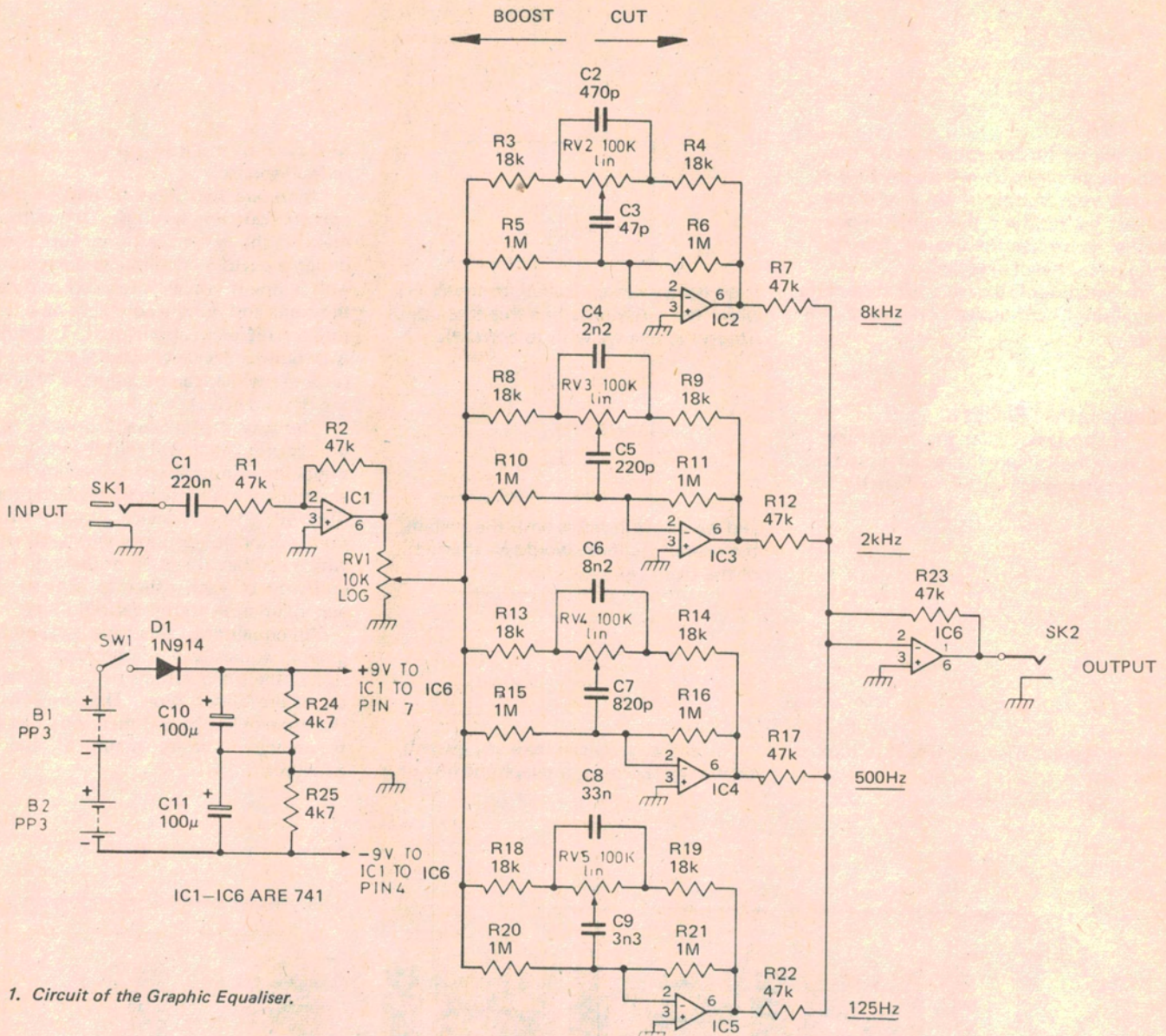

Fig. 1. Circuit of the Graphic Equaliser.

How It Works - ETI 491

The input to the unit is decoupled (to remove DC) by C1 and fed into IC1, which acts as a 'buffer' - it can be driven from a source with a very small current capability, which would be incapable of providing enough input otherwise. The output of IC1 is sufficiently powerful, however, to drive the rest of the circuit.

The output from IC1 is fed (via RV1, which controls the overall volume) to the four filter stages (ICs 2, 3, 4 and 5). These each respond to a particular frequency band and their output levels are adjustable by means of RVs 2, 3, 4 and 5. The outputs from these filters are summed by IC6, which acts as a virtual earth mixer. The "-" input is held at zero volts by virtue of the feedback through R23 and so the output of the unit is the inverted sum of the

voltages at the outputs of the filter ICs.

The individual filters work as follows: the feedback will cause the output to be equal to the input times $(-Z_f/Z_{in})$, where Z_f is the impedance from the output to the "-" input and Z_{in} is the impedance from RV1 to the "-" input.

This is the same situation as in the buffer - IC1. In its case, $Z_{in} = 47k$ and $Z_f = 47k$. Thus the output is -1 times the input (i.e. the signal will be 'inverted' - it will sound the same, though).

In the filters, if the variable resistor is at mid-position, with an equal resistance between the wiper and either end, then $Z_{in} = Z_f$. Thus each filter will pass all frequencies with output = -1 x input when the slider is in mid-position.

When the slider is at the left-hand end on the circuit diagram, however, the impedance of the capacitors will cause the gain of the filter (gain = output/input) to vary with frequency in such a way as to increase the gain in a particular frequency band.

Similarly, moving the slider to the other end of the potentiometer will cause the same band of frequencies to be attenuated.

Thus, by moving the slider from one end to the other, the response of the filter to its particular frequency band can be changed. As the output is the sum of all the filters' outputs, the overall frequency response of the unit will follow the shape the sliders make on the front panel - pushing one of them up will boost that particular frequency band.

Construction

All components, except the power switch, are mounted on the pcb. Take care to insert the electrolytic capacitors and ICs the right way round.

Use the front panel drawing to mark out the cutouts for the slide potentiometers. The cutouts can then be made by drilling small holes, as close as possible to each other, down the marked line. A small rat-tail file can then be used to file down the length of the cutout and a thin wide file to smooth the edges. They can be fairly sloppy as the front plate will hide any roughness.

The pcb can then be mounted off the front panel with four screws and 20 mm spacers. The positions for these screws are shown as black dots on the front panel and pcb artwork.

We used phono sockets for the input and output connections, however any other connector is suitable.

All components are easily obtainable except the slide potentiometers which we obtained from Radio Despatch Service in Sydney.

Operation

The input to the equaliser should be of a fairly high level, say between the pre-amp output and the main amplifier input. The output from a microphone or guitar would be too low for acceptable performance.

The sort of effects you can get from this unit are a telephone line (with the 500 Hz slider up and the rest down), a shout from a long way off (with the 8

kHz slider up and the rest down), or just a simple bass boost (with the sliders forming a diagonal up at the left).

Of course, by trying the unit yourself, you can adapt it to new applications or use it in conjunction with other effects units to provide a versatile addition to your effects equipment.

Hi-Fi

Naturally, if your hi-fi is stereo, you'll need two of these units. The ETI 485 Graphic Equaliser (June 77, Top Projects Vol 5), can be used for this application, however is more complex.

The unit should go between your pre-amplifier and power amplifier. The simplest way to adjust it is by ear, although it's not the most accurate method. You can reduce that annoying 'boominess' your speakers have always had, or boost the bass and treble and cut the middle from the signal from your tape recorder.

If you want to do it properly, however, you will need an Audio Spectrum Analyser such as the ETI 487 (Feb 78, Top Projects Vol 5). The equaliser is adjusted until the system's response to all frequencies is the same. Make sure the amplifier's tone controls are in mid-position.

This sounds simple enough — but remember that the room's response will change if you move the sofa or open the curtains — so first adjust these to their normal position. Also remember the neighbours!

PARTS LIST - ETI 491

Resistors	all ¼W, 5%
R1, R2	47k
R3, R4	18k
R5, R6	1M
R7	47k
R8, R9	18k
R10, R11	1M
R12	47k
R13, R14	18k
R15, R16	1M
R17	47k
R18, R19	18k
R20, R21	1M
R22, R23	47k
R24, R25	4k7
Potentiometers	
RV1	10k log Soanar slider pot
RV2, 3, 4, 5	100k linear Soanar slider pot
Capacitors	
C1	220n greencap
C2	470p ceramic
C3	47p ceramic
C4	2n2 greencap
C5	220p ceramic
C6	8n2 greencap
C7	820p ceramic
C8	33n greencap
C9	3n3 greencap
C10, 11	100µ 25V electros
Semiconductors	
IC1-IC6	741 8 pin DIL
D1	IN914
Miscellaneous	
SW1	spsst miniature toggle switch
SK1, 2	mono jack sockets
B1, 29V 216 batteries
Battery clips, box to suit (195 x 110 x 60 mm)	
pcb - ETI 491, 20 mm spacers, slider caps	

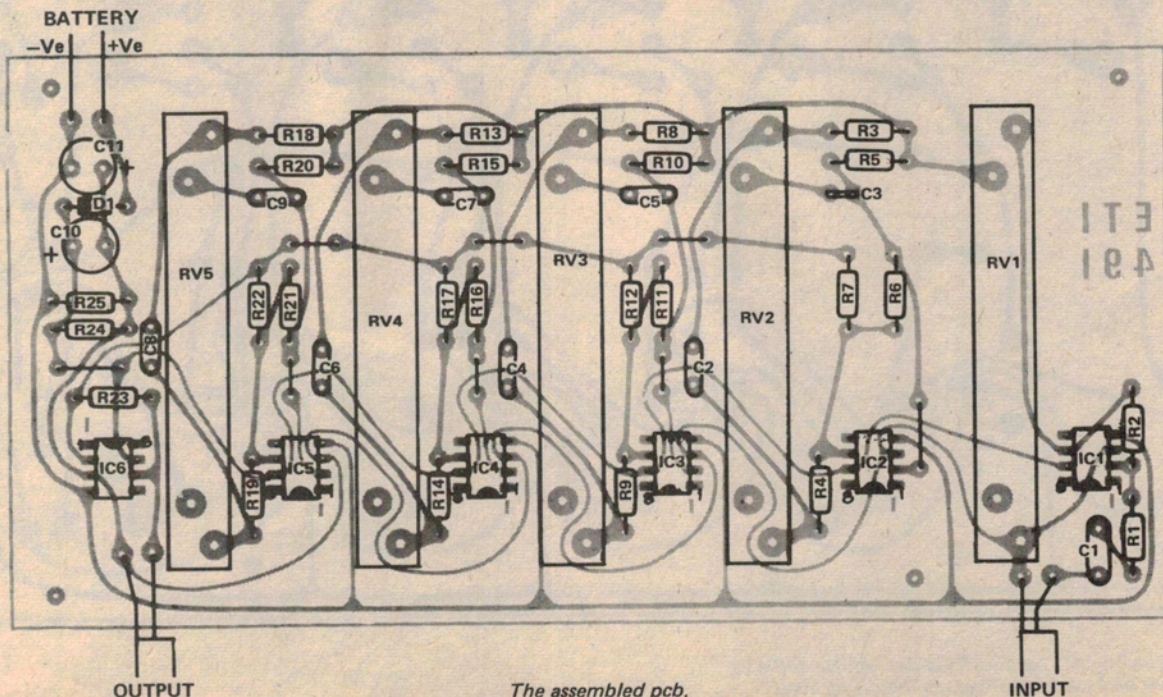

The assembled pcb.

Graphic Equaliser

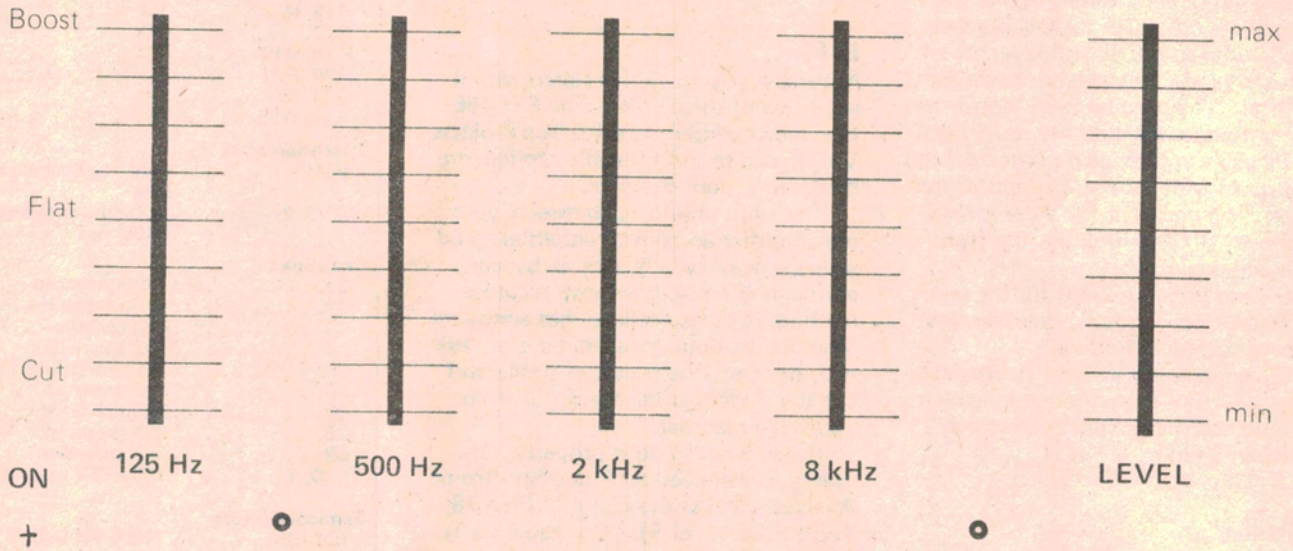

ETI 491

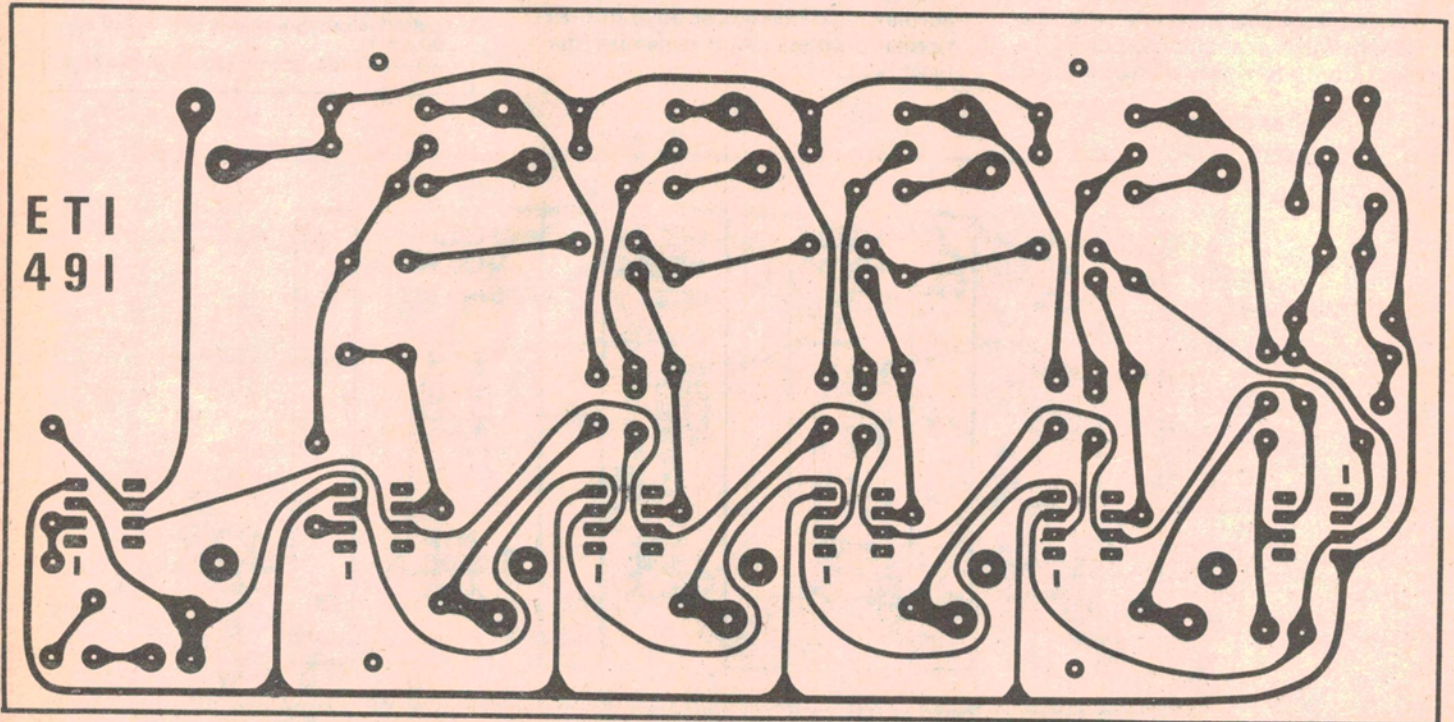

Front panel and pcb layouts for the Equaliser, shown full size.
Note the black pads on each for drilling the mounting holes.