

6-30-77

Data Sheet

jensen transformers
By REICHENBACH ENGINEERING

The 918 discrete operational amplifier is a low noise, high speed, low distortion circuit with output current capability to ~ 250 ma peak. The circuit is public domain, and you may use it any way without license.

AUG 9, '05
NO LONGER
THERE IN
SAN DIEGO.
OWNED BY
HARRIS CORP.
NOW. THE
918 AMP IS
NO LONGER
AVAILABLE.

An assembled $1\frac{1}{2} \times 2 \times \frac{3}{4}$ " high unpotted module is being offered by Pacific Recorders & Engineering in San Diego. (Jack Williams - 714-453-3255)

They are using a double sided PC board with the topside as a shield, silk screened labeling for components and a cover which is removable for servicing. The input transistor pair is selected for $h_{fe} > 450$ and 1% match.

Along with V_{be} matching, this is resulting in < 5 mV offset with equal resistances on each input.

Gain Bandwidth is 10 MHz, large Signal Bandwidth is 65 kHz
Slew Rate is 5.5 V/ μ s. Noise is < 3 nV/ $\sqrt{\text{Hz}}$ en, and $I_n < 0.50$ pA/ $\sqrt{\text{Hz}}$.

Please feel free to call me for further info.

Deane Jensen.

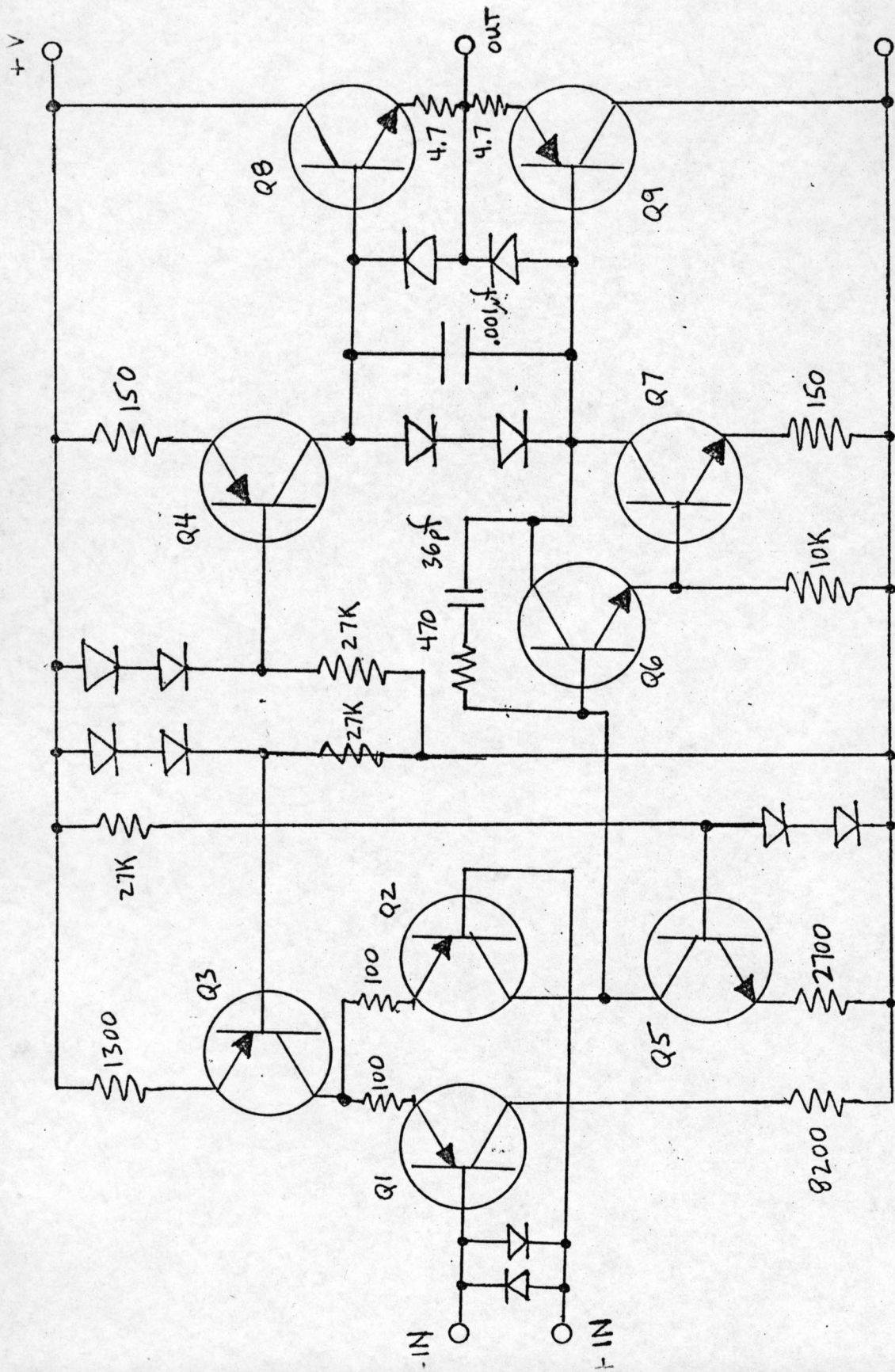

Values shown are optimum for ± 15 volt supply. See separate sheet for ± 24 volt operation.

Q8, MJE-181
Q9, MJE-171

All diodes (12), 1N914B
Q1-Q4, ZN4250A
Q5-Q7, ZN2484

EXTERNAL CIRCUITS FOR OPERATIONAL AMPLIFIER

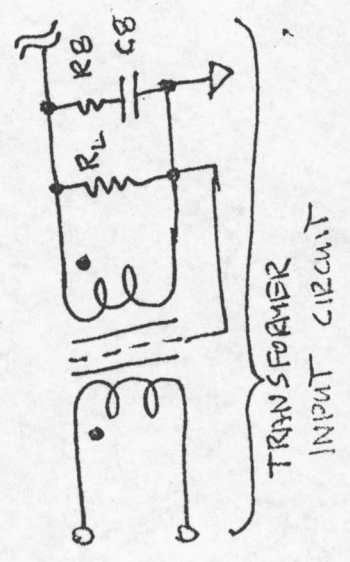
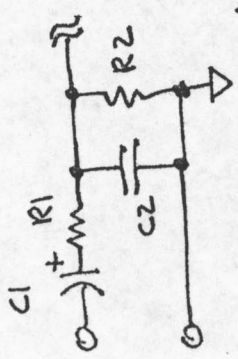
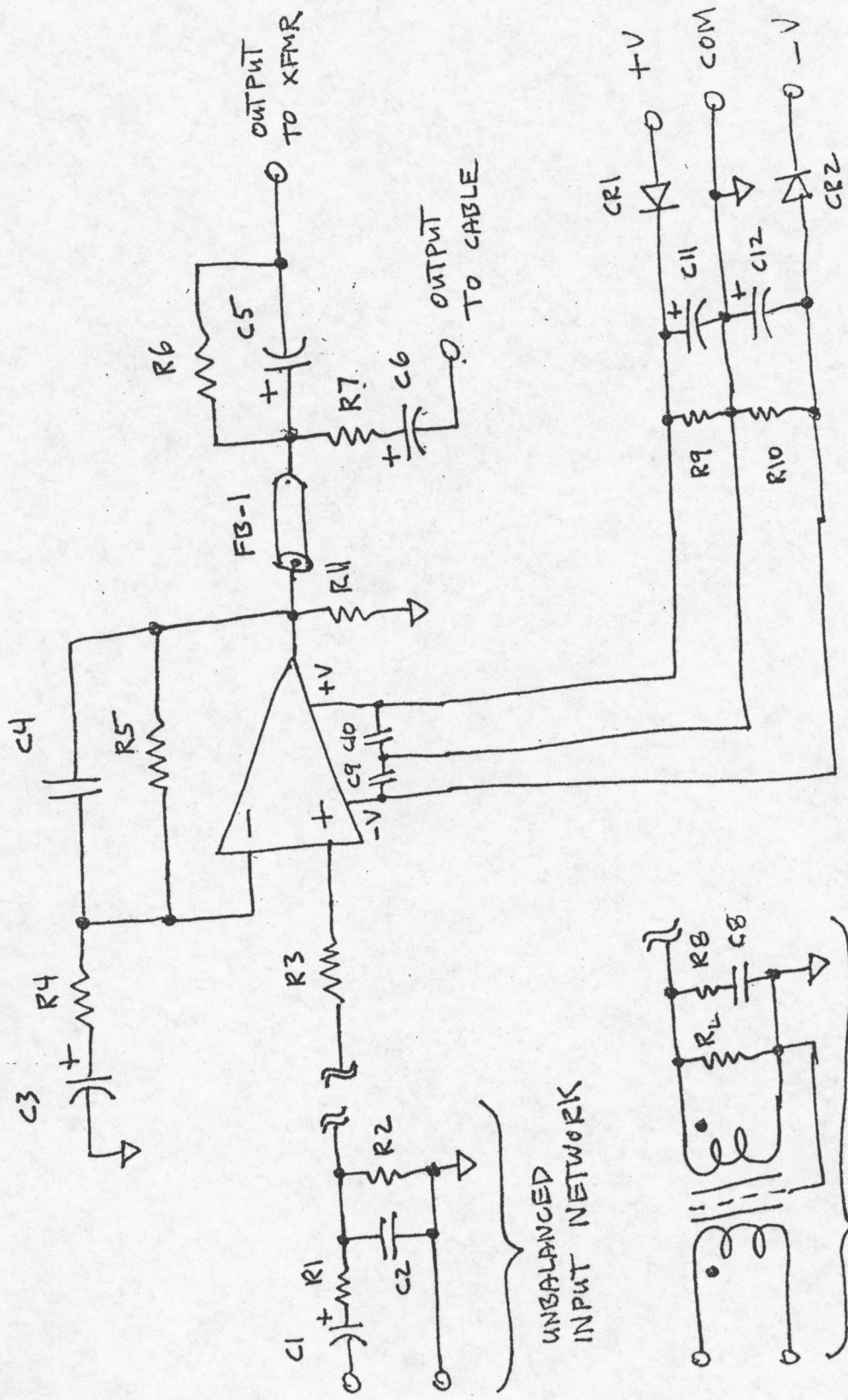

11-2-76
DATE

PAGE

EXTERNAL CIRCUITS FOR
OPERATIONAL AMPLIFIER — PARTS LIST

1
2
3
4
5
6
7
8
9
10
11
12
13
14
15
16
17
18
19
20
21
22
23
24
25
26
27
28
29
30
31
32
33
34
35
36
37
38

R1	2700 ohm
R2	100K
R3	1K (req'd only on 318)
R4	270 To 27K
R5	27K
R6	33
R7	10
R8	.
R9, 10	15K
R11	27K
C1	1.5 uf
C2	270 pf
C3	220 uf
C4	75 pf
C5	1000 uf
C6	150 uf
C7	—
C8	
C9, 10	0.1 uf
C11, 12	220 uf
CR1, 2	1N4001

11-16-76

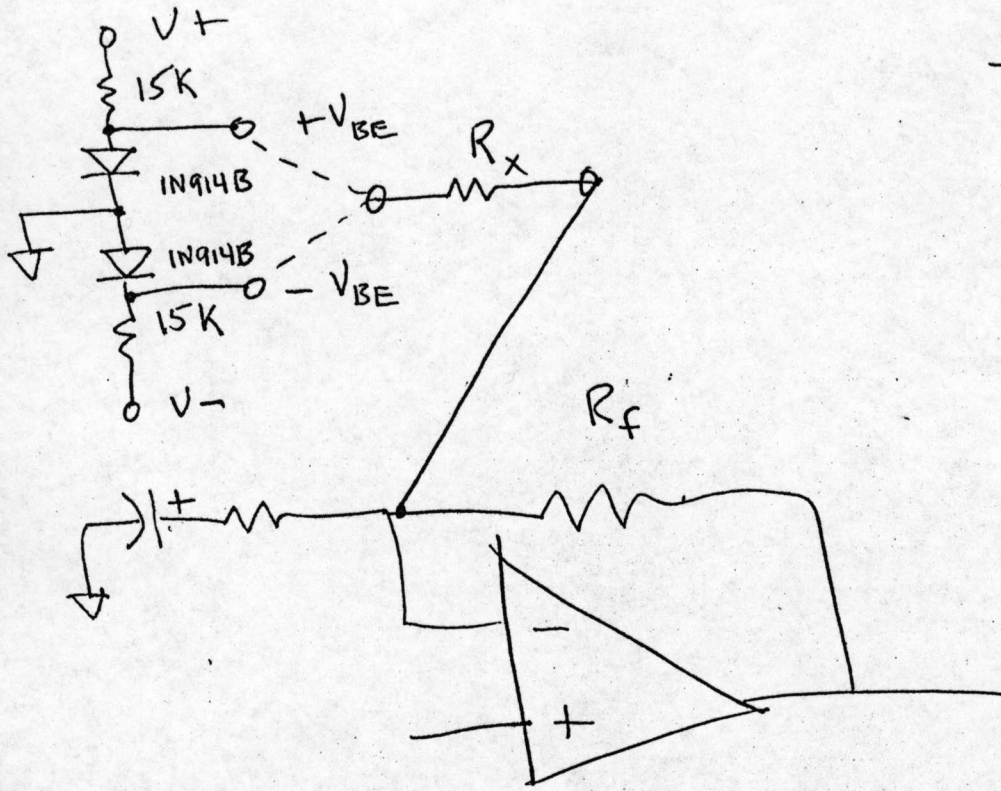

Offset compensation method.

Select value for R_x to null offset. Connect to + or - V_{BE} point depending upon polarity of offset to be compensated.

$$R_x \approx \frac{V_{BE} R_f}{V_{os}}$$

where: R_x is compensation res.
 R_f is feedback res.
 V_{os} is Voltage offset
 $V_{BE} \approx 0.68V$.

For $R_f = 27K$

V_{os}	R_x
10 mV.	1.8 meg
20 mV.	900 K
50 mV.	370 K

918 OPERATIONAL AMPLIFIER

<1> OPEN LOOP GAIN

<2> MAXIMUM CLOSED LOOP GAIN

<3> MINIMUM CLOSED LOOP GAIN

CLOSED LOOP GAIN CURVES SHOWN WITH 2 μ S

PHASE LEAD COMPENSATION IN FEEDBACK CIRCUIT

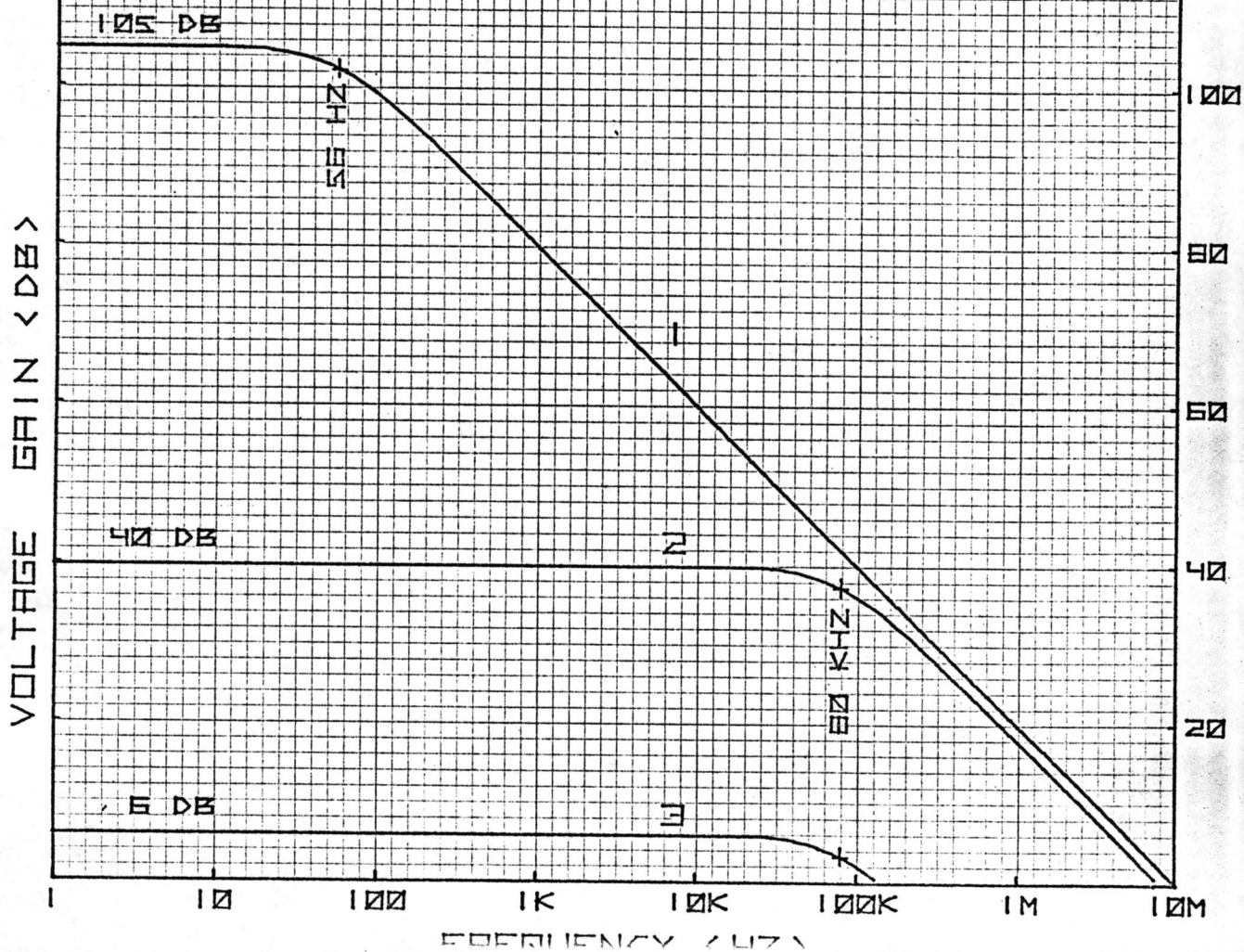

CURVE CODE

1 KHZ - 1
 20 KHZ - 2

$F_{VCL} = 2$ - 1
 10 - 2
 100 - 3

NO LOAD - 1
 $R_L = 150$ - 2

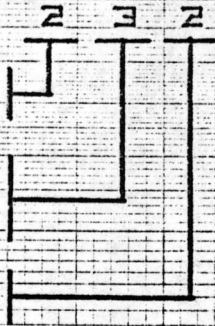

TOTAL HARMONIC DISTORTION

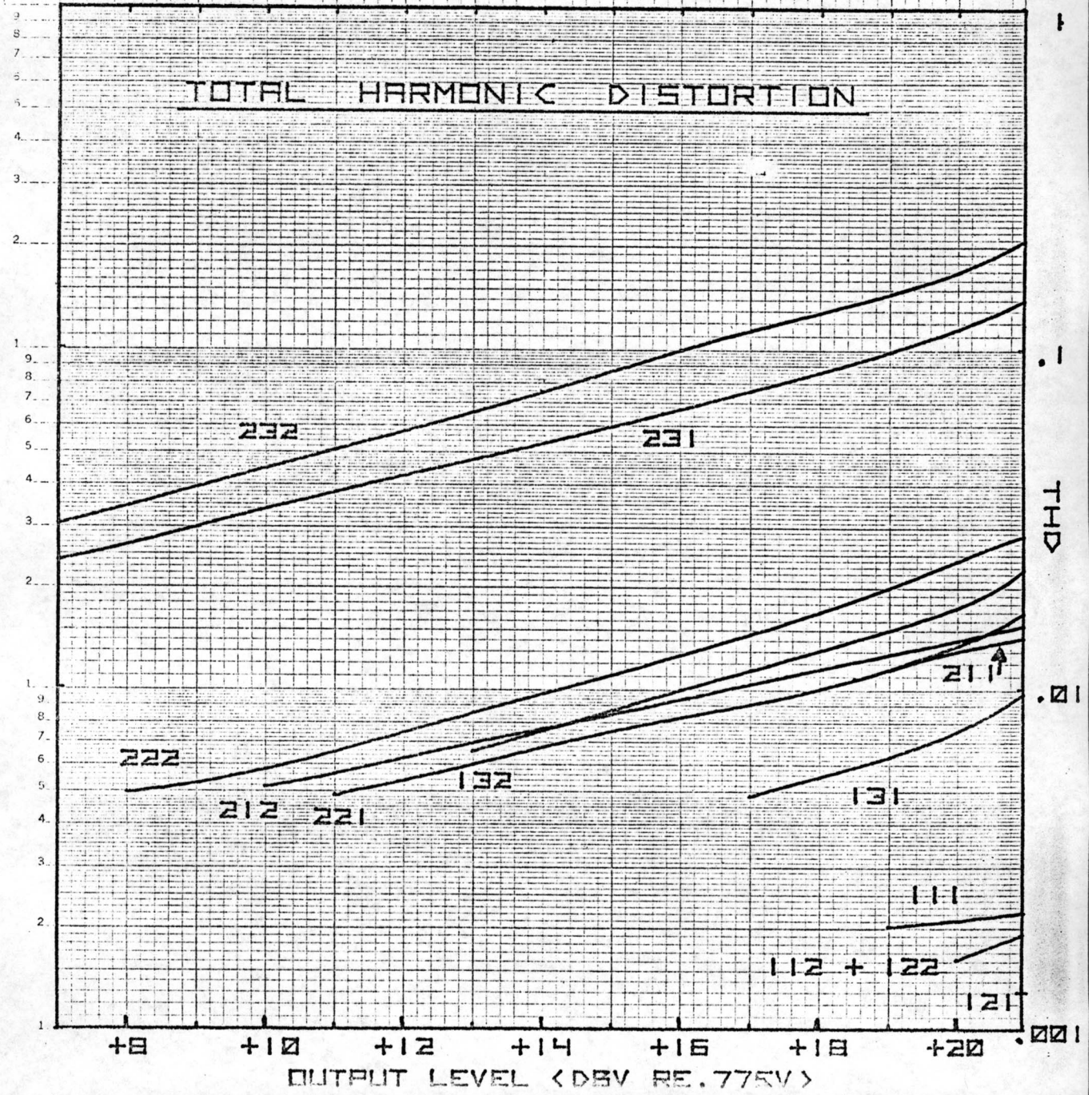

OUTPUT LEVEL < DBV RE. 775V >

14 13 12 11 10 9 8 7 6 5 4 3 2 1

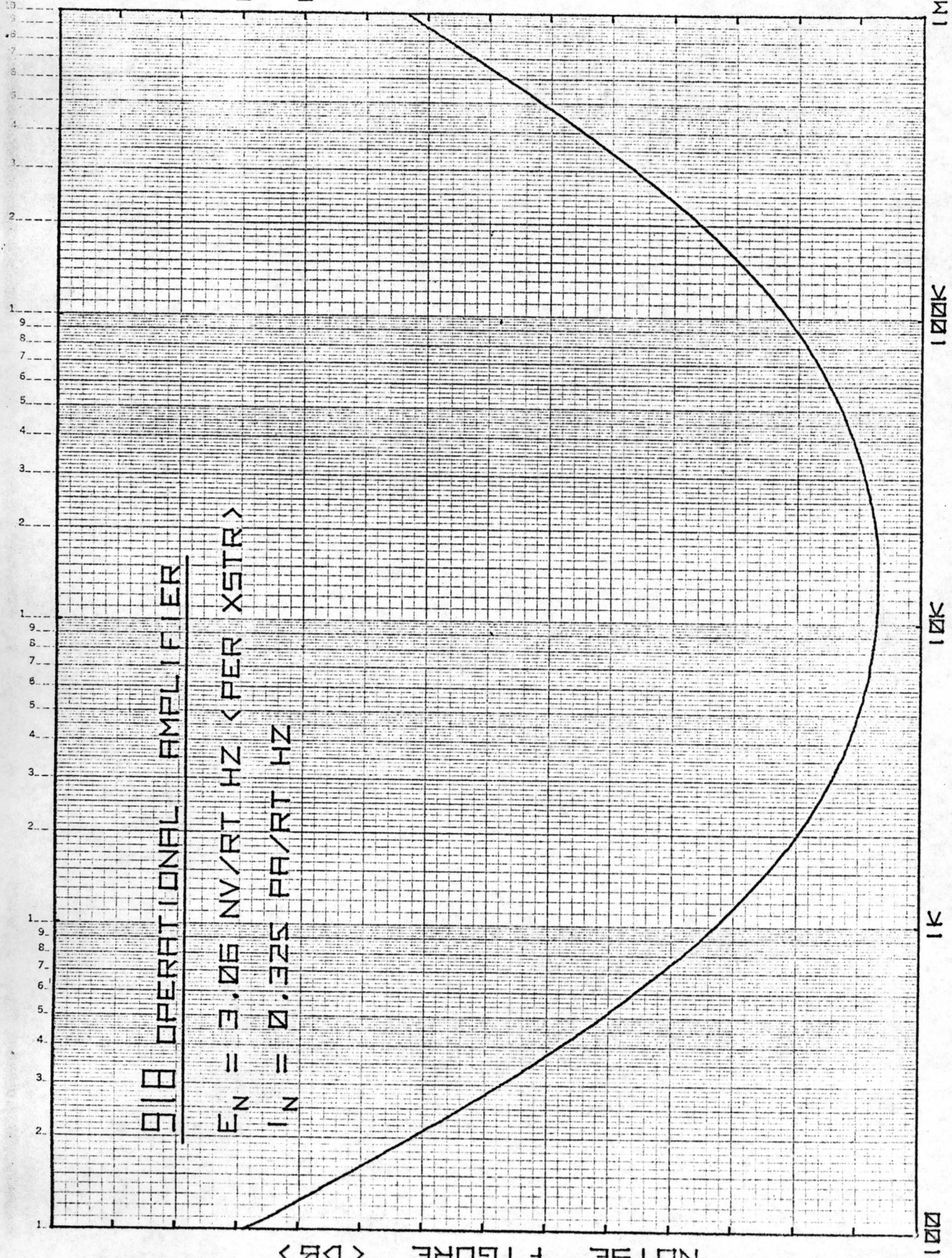

918 OPERATIONAL AMPLIFIER

$E_N = 3.06 \text{ NV/RT HZ } \langle \text{PER XSTR} \rangle$

$I_N = 0.325 \text{ PA/RT HZ}$

NOISE FIGURE < DB >

100 1K 10K 100K 1M

SOURCE IMPEDANCE < OHM >

EQUIVALENT INPUT NOISE < DBV RE. 775V >

918 OPERATIONAL AMPLIFIER

$E_N = 3.06 \text{ NV}/\sqrt{\text{RT HZ}} < \text{PER XSTR} >$

$I_N = 0.325 \text{ PA}/\text{RT HZ}$

$BW = 20 \text{ KHZ}$

