

Designing Active AC Filters

JOSEPH J. CARR



Low-pass, high-pass, band-pass and notch—they're all here!

ELECTRONIC FREQUENCY-SELECTIVE AC filters (*filters*) are circuits that favor some frequencies and discriminate against other frequencies. Frequencies that pass through the filter with little attenuation are the *passband*, while attenuated frequencies are the *stopband*.

Filter circuits are classified in several ways: Passive vs. active, analog vs. digital vs. software, by frequency range (e.g. audio, RF, or microwave), or by passband characteristic. *Passive filters* are made of various combinations of passive components such as resistors (R), capacitors (C), and inductors (L). In general, passive filters are lossy; they attenuate the signal

and amplification might be ultimately required. *Active filters*, on the other hand, are based on active electronic devices such as a transistor or an operational amplifier along with passive components (R, C, and L) that determine frequency. The passive components are customarily composed of resistors and capacitors for they are cheaper and easier to obtain than inductors.

There are all kinds of filters. *Active filters* use analog linear-circuit techniques such as those applying to operational amplifiers. *Digital filters* use digital IC devices, and are often based on capacitor-switching techniques. *Software filters* im-

plement solutions to frequency-selective equations using computer programming techniques.

Filters are also classified by frequency range. *Audio filters* operate from the sub-audio to ultrasonic ranges (near-DC to about 20-kHz). *RF filters* operate at frequencies above 20-kHz, up to about 900-MHz. *Microwave filters* operate at frequencies greater than 900-MHz. These range designations are not absolute, but do serve to indicate approximate points at which a change of design technique generally takes place. The filter circuits discussed in this article are audio-active filters that have a passband between

the sub-audio and the low-ultrasonic regions.

Finally, filters are classified by the nature of their frequency-response characteristics. This method of categorizing filters takes note of the filter's passband and stopband. Low-pass filters, high-pass filters, band-pass filters, and stopband filters will be discussed in this article.

Filter characteristics

Figure 1 shows the frequency-range categories for ideal filters. A low-pass filter has a passband from DC (zero Hertz) to a specified cut-off frequency (f_1). All frequencies above the cut-off frequency are attenuated, so they are in the stopband. A band-pass filter has a passband between a lower limit (f_2) and an upper limit (f_3). All frequencies lower than f_2 or greater than f_3 are in the stopband. A high-pass filter has a stopband from DC to a certain lower limit (f_4). All frequencies greater than f_4 are in the passband.

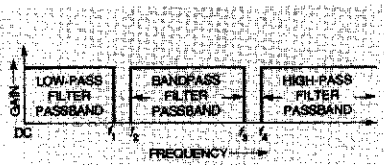

FIG. 1—IDEALIZED frequency-responses curves for low-pass, bandpass and high-pass AC filter circuits.

A stopband filter response is shown in Fig. 2. This filter attenuates frequencies between lower and upper limits (f_5 to f_6), but passes all others. When the stopband is very narrow, the stopband filter is called a notch filter. This filter type is often used to remove a single, unwanted frequency. An example of such an application is removal of unwanted 60-Hz interference (AC hum) caused by proximity to the AC power line.

Ideal vs. practice

The frequency-response

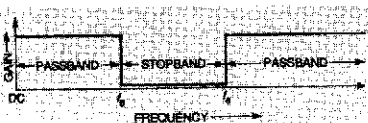

FIG. 2—IDEALIZED frequency-response curve for stopband AC filter circuits.

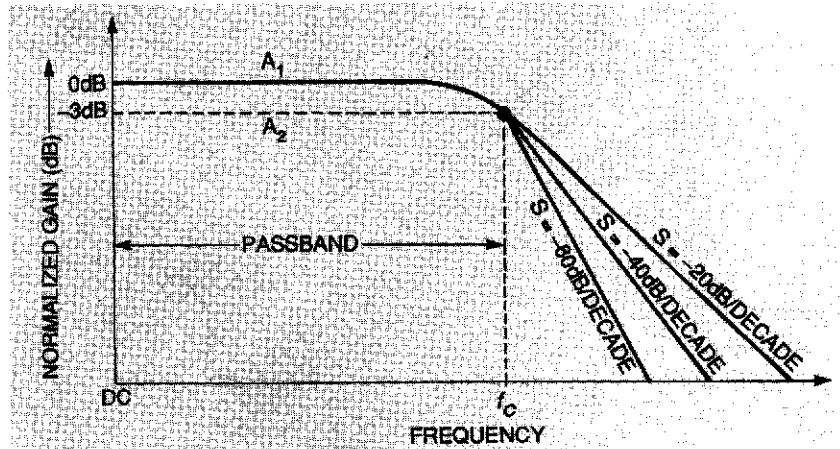

FIG. 3—TYPICAL LOW-PASS FILTER passband frequency-response curves for first, second and third-order Butterworth filters.

curves shown in Figs. 1 and 2 are idealized. In real life the corners of the curves are rounded and not squares, and the vertical lines are gentle to steep slopes as illustrated in Fig. 3. The Butterworth, Chebyshev, Cauer (also sometimes called elliptic), and Bessel filters are among the typical filters used. The ideal Butterworth frequency-response curve is shown in Fig. 3. The noteworthy properties of the Butterworth filter is that both the passband and stopband are relatively flat, and the transition region slope between them is continuous.

Standard practice in filter nomenclature is to specify the passband between frequencies where the frequency response falls off 3 dB from the mid-passband gain. In Fig. 3, the cut-off frequency (f_c) is at the point where gain (A_2) falls off by a factor of 0.707 to a designated gain value called A_1 . At that spot in the frequency-response curve, the reference point is called the *-3-dB point*.

At frequencies greater than f_c , the gain falls off linearly at a rate that depends on the order of the filter. The slope (S) of the fall off is measured in either decibels per octave (a 2:1 frequency change) or decibels per decade (a 10:1 frequency change). Note that these two specifications can be scaled relative to each other: -6 -dB/octave has the same slope as -20 -dB/decade. The slopes shown in Fig. 3 cover three Butterworth cases. A first-

order filter has a roll-off of -20 -dB/decade, a second-order filter has a roll-off of -40 -dB/decade, and a third-order filter has a roll-off at -60 -dB/decade. These slopes are the same as 6, 12 and 18-dB/octave, respectively.

It might appear that only third-order filters are used because the transition from passband to stopband is most rapid (steep). But higher-order frequency-response filtering is obtained at the cost of more complexity, greater sensitivity to component value error, and difficult design configurations. Some higher-order filter designs are also more likely to oscillate than lower-order equivalents. The selection of filter order is a trade-off between system needs and complexity.

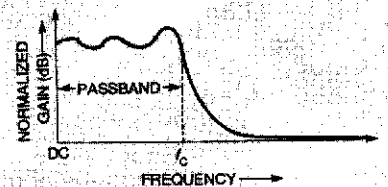

FIG. 4—PASSBAND FOR LOW-PASS Chebyshev AC filter reveals a rapid gain fall-off at the cut-off frequency, f_c .

The steepness and shape of the roll-off curve is a function of the filter's damping factor. Butterworth filters tend to be heavily damped, which explains the gradual roll-off in the response curve. The Chebyshev filter frequency-response curve shown in Fig. 4 is lightly damped, so it

has a variation (or "ripple") within the passband. The Chebyshev filter offers a faster gain roll-off than the Butterworth filter, but at the cost of less flatness within the passband.

The Caer or elliptic filter's frequency-response curve shown in Fig. 5 offers the fastest roll-off at the cut-off frequency (f_c), as well as relatively good flatness within the passband. Notches of -40 dB to -60 dB can be achieved close to f_c , but only at a cost of less attenuation further into the stopband. A typical Caer filter response has a deep notch close to f_c , rises to a peak at some high frequency, and then gradually falls off for even higher frequencies at a rate of -20 -dB to -40 -dB/decade.

The frequency-response curve for the Bessel filter is shown in Fig. 6. Although it appears similar to the Butterworth response, its gain is not flat within the passband. The benefit of the Bessel filter is a flat phase response across the passband.

Filter phase response

Most filter circuits exhibit a phase change over the passband. The responses for the Butterworth and Bessel filters are shown in Fig. 7. Note that the maximal flat Butterworth curve exhibits a decidedly non-linear phase response in both passband and stopband. The frequency dependent phase shift of a low-pass filter is -45 degrees at f_c , and increases by a factor of -45 degrees for each additional increase of -20 -dB/decade in the roll-off slope.

The Bessel filter also shows a phase shift over the passband, but it is nearly linear. A useful feature of this characteristic is that it allows a uniform time delay all across the passband. As a result, the Bessel filter offers the ability to pass transient pulse wave forms with minimum distortion. The Bessel filter is said to work best at the frequency where $f = f_c/2$.

Low-pass filters

A diagram for a low-pass filter

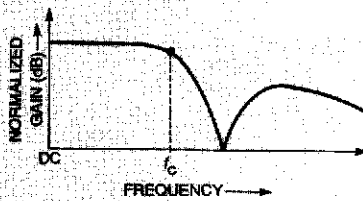

FIG. 5—PASSBAND for the Caer or Elliptic AC filter.

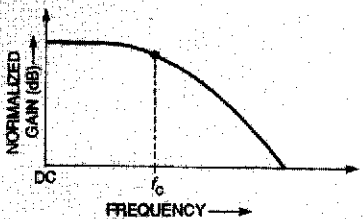

FIG. 6—PASSBAND for the Bessel AC filter.

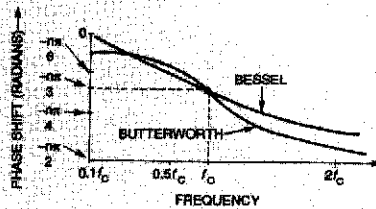

FIG. 7—COMPARISON of signal phase response for the Butterworth and Bessel AC filters.

circuit is shown in Fig. 8. This filter is called the voltage-controlled-voltage-source (VCVS) filter. The basic configuration is a non-inverting-follower operational amplifier (IC1). The operational amplifier selected should have a high-gain bandwidth, relative to the cut-off frequency, in order to permit the filter to operate properly. The gain of the circuit is given by:

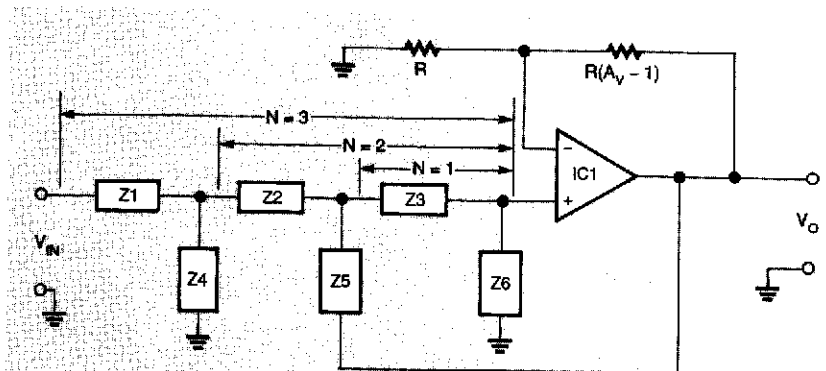

FIG. 8—HERE'S A SIMPLIFIED SCHEMATIC for a low-pass design known as a voltage-controlled-voltage-source (VCVS) filter.

FIG. 9—FIRST-ORDER VCVS low-pass filter circuit using a typical operational amplifier.

$$A_v = (R_f/R_{in})$$

When $R_{in} = R$:

$$R_f = R(A_v - 1)$$

In some circuits, the gain may be unity. In those circuits the resistor voltage-divider feedback network is replaced with a single connection between output and the inverting input.

The input circuitry of the generic VCVS filter consists of a network of impedances labeled Z1 through Z6. Each of these blocks will be either a resistance (R) or a complex capacitive reactance ($-jX_c$). Which element becomes which type of component is determined by whether the filter is a low-pass or high-pass type.

The order of the filter, denoted by n , refers to the number of poles in the design, or in practical terms, the number of RC sections. A first-order filter ($n = 1$) consists of Z3 and Z6 (Fig. 8), a second-order filter ($n = 2$) consists of Z2, Z3, Z5 and Z6, and a third-order filter ($n = 3$) consists of all six impedances (Z1 through Z6). Higher order filters (n greater than 3) can also

be built. In a low-pass filter Z1 through Z3 are resistances, while Z4 through Z6 are capacitances. The component types are reversed in high-pass filters.

First-order low-pass filters

The first-order low-pass VCVS filter is shown in Fig. 9, and its frequency-response curve is shown in Fig. 3 (slope $S = -20$ -dB/decade). The filter consists of a single-section RC low-pass filter driving the non-inverting input of an operational amplifier. The gain of the operational amplifier is $[(R2/R3) + 1]$. The high-input impedance of IC1 prevents loading of the RC network. The general form of the transfer equation for the gain vs. frequency response for the first-order filter is:

$$A_{dB} = 20\text{LOG}(A_v) - 20\text{LOG}[1 + (\omega/\omega_o)^2]^{1/2}$$

where: A_{dB} is the gain of the circuit in decibels; A_v is the voltage gain within the passband; LOG denotes the base-10 logarithms; ω_o is the ratio of the input frequency to the cut-off frequency ($f_o = f/f_c$).

The voltage at the output of the RC network (V_a) is found from the voltage divider equation:

$$V_a = -jX_c V_{in} / (R - jX_c)$$

where: $-jX_c = 1/(j2\pi fC)$ and j is the imaginary operator $[(-1)^{1/2}]$.

Substituting the value for $-jX_c$:

$$V_a = [V_{in}/j2\pi fC] / [R + 1/j2\pi fC]$$

which simplifies to:

$$V_a = V_{in} / [1 + \pi fCR]$$

If the transfer function of the non-inverting follower is:

$$V_o = V_{in} [(R2/R3) + 1]$$

and since $V_{in} = V_a$:

$$V_o = [V_{in} / (1 + 2\pi fCR)] \times [(R2/R3) + 1]$$

The above equation is put into a more workable form:

$$V_o/V_{in} = [A_v / (1 + jf/f_c)]$$

where: V_o is the output signal voltage; V_{in} is the input signal voltage; A_v is the passband gain $[(R2/R3) + 1]$; f is the signal frequency; and f_c is the -3 -dB fre-

quency $(1/2\pi RC)$.

The filter parameters are required to define the operation of any particular circuit. The *gain magnitude* and *phase shift* are found from the following equations:

Gain magnitude:

$$V_o/V_{in} = A_v [1 + (f/f_c)^2]^{1/2}$$

and *phase-shift angle* (in radians):

$$\phi = -\text{Tan}^{-1}(f/f_c)$$

Because the filter characterization depends in part on the ratio f/f_c , the equations take different forms at different values of f and f_c . These can be reduced as follows:

At low frequencies that are well within the passband (f is less than f_c):

$$V_o/V_{in} = A_v = (R2/R3) + 1$$

At the -3 -dB cut-off frequency ($f = f_c$):

$$V_o/V_{in} = 0.707A_v$$

At a high frequency that is well above the -3 -dB cut-off frequency (f greater than f_c):

$$V_o/V_{in} < A_v$$

Table 1 shows the characteristics of first-order filters at several different ratios of f/f_c .

Designing a first-order low-pass filter

There are two basic ways to

determine the component values for the low-pass filter shown in Fig. 9: ground-up and frequency-scaling methods. The following is the ground-up method:

1. Select the -3 -dB cut-off frequency (f_c) required.
2. Select a standard-value capacitor value.
3. Calculate the required resistance for $R1$:

$$R1 = 1/2\pi f_c C$$

4. Select the passband gain for f less than f_c .
5. Select a value for R , and
6. Calculate R_f from:

$$R_f = R(A_v - 1)$$

Example

A low-pass filter shown in Fig. 9 is needed to process a transducer signal. The cut-off frequency should be 100-Hz, and the gain should be 5. The solution is:

1. $F_c = 100$ -Hz
2. Select trial value for $C1$: 0.1 - μ F
3. Calculate $R1$:

$$R1 = 1/2\pi F_c C1$$

$$R1 = 15,923 \text{ ohms}$$

4. Select a trial value for $R1$: 10,000 ohms. Then calculate R_f :

$$R_f = 40,000 \text{ ohms}$$

Design by normalized model

The filter design can be simplified by using a normalized

TABLE 1—FILTER CHARACTERISTICS

Applied Frequency (Hz)	Gain Magnitude		Phase Shift (degrees)
	A_v	dB	
10	2.00	6.020	-0.57
20	1.999	6.018	-1.15
50	1.998	6.009	-2.86
80	1.994	5.993	-4.57
100	1.990	5.977	-5.71
200	1.961	5.850	-11.31
500	1.789	5.052	-26.57
800	1.561	3.872	-38.66
1000	1.414	3.010	-45.00
2000	0.894	-0.969	-63.43
5000	0.392	-8.129	-78.69
8000	0.248	-12.109	-82.87
10000	0.199	-14.023	-84.29
20000	0.100	-20.011	-87.14
50000	0.040	-27.960	-88.85
80000	0.025	-32.042	-89.28
100000	0.020	-33.980	-89.43

model. First, design a filter for a standardized frequency (e.g. 1-Hz, 10-Hz, 100-Hz, 1000-Hz or 10,000-Hz) and list the component values. The values for any other frequency can then be computed by a simple ratio and proportion. An example of a first-order low-pass Butterworth filter is shown in Fig. 10 with the component values normalized for 1 kHz. The actual required component values ($R1'$ and $C1'$) are found by dividing the normalized values shown by the desired cut-off frequency in kilohertz:

$$C1' = (C1)(1\text{-kHz})/f$$

or

$$R1' = (R1)(1\text{-kHz})/f$$

Note: The value for f in above two equations is in kilohertz (kHz) units.

Leave one of the values alone, and calculate the other. In general, it is easier to obtain precision resistors in unusual values (or the value obtained by a potentiometer), so it is common practice to select a standard capacitance and calculate the required resistance.

Example:

Change the frequency of the normalized 1-kHz filter to 60 Hz (i.e. 0.06 kHz).

$$C1' = (C1)(1\text{-kHz})/f = 0.265 \mu\text{F}$$

Second-order low-pass filters

The circuit for a second-order, low-pass filter is shown in Fig. 11, while the response curve with a -40-dB/decade slope is shown in Fig. 3. This circuit is similar to the first-order filter (Fig. 10), but with an additional RC network in the frequency-selective portion of the circuit. The circuit is wired for unity gain.

The purpose of $R3$ in Fig. 11 is to help counteract the DC offset at the output of the operational amplifier that is created by input bias currents charging the capacitors in the frequency selective network. The value of $R3$ in the unity gain case is $2R$, where R is the value of the resistors in the frequency selective network. In cases where DC

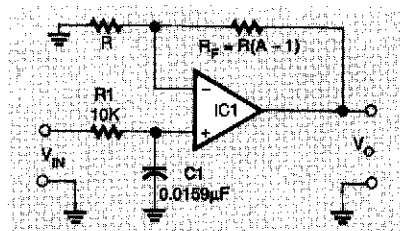

FIG. 10—FIRST-ORDER VCVS low-pass filter circuit normalized to 1-kHz by the selection of component values.

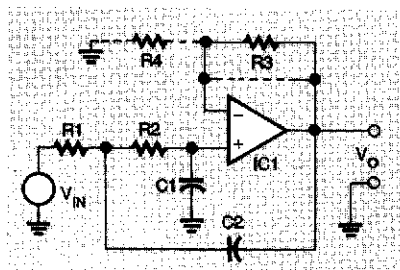

FIG. 11—SECOND-ORDER VCVS low-pass filter circuit normalized to 1 kHz by the selection of component values.

offset is not a problem, resistor $R3$ can be replaced with a short circuit between the operational amplifier output and the inverting input. If passband gain for the second-order, low-pass filter is required, then resistors $R3$ and $R4$ are used.

The second-order VCVS filter is by far the most commonly used type. Its -40-dB/decade roll-off, coupled with a high degree of stability, results in a generally good trade-off between performance and complexity.

The general form of the second-order filter transfer equation is similar to the expression for the first-order filter:

$$A_{\text{dB}} = 20\text{LOG}(A_v) - 20\text{LOG}[(\omega/\omega_c)^4 + (a^2 - 2)(\omega/\omega_c)^2 + 1]^{1/2}$$

where a is the damping factor of the circuit, and other terms are as defined earlier for the first-order case.

The damping factor (a) is determined by the form of filter circuit. For the Butterworth design the value of a is 1.414.

The passband gain for this circuit is the normal gain for any non-inverting follower/amplifier. If the output is strapped directly to the inverting input, or if $R3$ (but not $R4$) is used in the feedback network, then the gain is unity ($A_v = +1$). For

gains greater than unity ($A_v > 1$), the following is true:

$$A_v = (R3/R4) + 1$$

The cut-off frequency (f_c) is the frequency at which the voltage gain drops -3 dB from the passband gain. This gain is found from:

$$A_v = 1/[2\pi(R1R2C1C2)]^{1/2}$$

The gain magnitude (V_o/V_{in}) is found in a manner similar to the first-order case:

$$V_o/V_{in} = A_v/[1 + (f/f_c)^4]^{1/2}$$

There is no requirement in VCVS filters that like components (R or C) in the frequency selective network be made equal, but such a step simplifies the design procedure. If $R1 = R2 = R$, and $C1 = C2 = C$, then:

$$f_c = 1/2\pi RC$$

A constraint on this simplification is that the Butterworth response is guaranteed only if A_v is equal to or greater than 1.586.

Design procedure

1. Select the -3-dB cut-off frequency (f_c) based on the circuit requirements and applications.
2. Select a standard value capacitance.
3. Calculate the required resistance from:

$$R1 = 1/2\pi f_c C$$

4. Select the passband gain for f less than f_c .
5. Select a value for resistor $R4$, and
6. Calculate $R3$ from:

$$R3 = R4(A_v - 1)$$

The normalized 1-kHz trial values for doing scaling design of the second-order low-pass filter are shown in Fig. 11. The design here is based on a more complex arrangement whereby $C2 = 2C1$. Some designers maintain that this is the superior design. The same scaling rule is applied to the second-order filter as used in the first-order design.

Now that you know a little smoke about the low-pass filter we are going to change gears and look at the high-pass and band-pass filter circuits.

High-pass filters

The function of the high-pass filter is the inverse to that of the low-pass filter, so one can reasonably expect its frequency-response characteristic to mirror that of the low-pass filter response. Figure 12 shows the high-pass filter response with roll-off slopes of -20 -, -40 -, and -60 -dB/decade. Compare the frequency-response curves in Fig. 12 to those in Fig. 3. The passband of the high-pass filter are all frequencies above the cut-off frequency f_c . As in the low-pass case, f_c is the frequency at which passband gain drops -3 dB; that is $A_{vc} = 0.707A_v$.

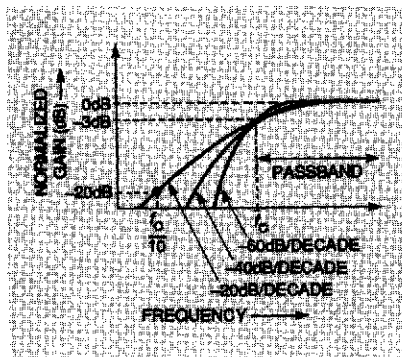

FIG. 12—FREQUENCY RESPONSE characteristic for first-order, second-order and third-order VCVS high-pass AC filters.

The cut-off frequency phase shift in a high-pass filter has the same magnitude as the low-pass case, but the sign is opposite. At f_c , the high-pass filter exhibits a phase shift of $+45$ degrees per 20 -dB/decade of roll-off. Put another way, the phase shift is $(n \times 45\text{-degrees})$, where n is the order of the filter.

The high-pass versions of the VCVS filters are of the same form as the low-pass filter. In the case of the high-pass filter, however, impedances $Z1$ through $Z3$ are capacitances, while $Z4$ through $Z6$ are resistances (Fig. 8). In the high-pass filter the roles of the resistors and capacitors are reversed.

First-order high-pass filters

The circuit for a first-order high-pass filter is shown in Fig. 13. This circuit is identical to the first-order low-pass filter in which the roles of $C1$ and $R1$ are

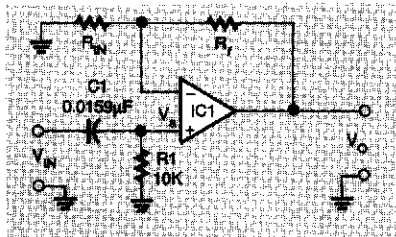

FIG. 13—FIRST-ORDER VCVS high-pass filter circuit normalized to 1-kHz by the selection of component values.

interchanged (see Fig. 10). The high-pass filter shown here is normalized for 1 kHz. Passband gain of this circuit is:

$$A_v = (R_f/R_{in}) + 1$$

The voltage at the non-inverting input of the operational amplifier (V_a) is developed across resistor $R1$, and is given by:

$$V_a = j2\pi f R1 C1 V_{in} / (1 + j2\pi f R1 C1)$$

The transfer equation for the circuit is:

$$V_o = A_v V_a$$

$$V_o = [(R_f/R_{in}) + 1] \times [j2\pi f R1 C1 V_{in} / (1 + j2\pi f R1 C1)]$$

And, in the traditional form, the equation becomes:

$$V_o/V_{in} = A_v (f/f_c) / [1 + (f/f_c)]$$

As in the previous cases, the cut-off frequency f_c is found from:

$$f_c = 1/2\pi R1 C1$$

The gain magnitude of this circuit is the absolute value of the traditional form of the transfer equation:

$$V_o/V_{in} = A_v (f/f_c) / [1 + (f/f_c)^2]^{1/2}$$

The VCVS high-pass filter shown in Fig. 6 is normalized to 1 kHz. The same scaling technique is used for this circuit as was used for the low-pass filters discussed earlier.

Second-order high-pass filter

The second-order high-pass filter offers a roll-off slope of -40 dB/decade as illustrated in Fig. 12. This VCVS filter circuit (Fig. 14) is, like its low-pass counterpart, probably the most commonly used form of high-pass filter. The circuit is similar to the low-pass design except for a reversal of the roles of capaci-

tors and resistors. The cut-off frequency is the frequency at which gain falls off -3 dB, and is found from:

$$f_c = 1/2\pi [R1 R2 C1 C2]^{1/2}$$

or, in the case where $R1 = R2 = R$, and $C1 = C2 = C$:

$$f_c = 1/2\pi RC$$

The gain magnitude of the circuit is found from:

$$V_o/V_{in} = A_v / [1 + (f_c/f)^4]^{1/2}$$

Example

Calculate the cut-off frequency of a filter shown in Fig. 14 in which $C1 = C2 = 0.0056 \mu\text{F}$ and $R1 = R2 = 22,000$ ohms.

$$f_c = 1/2\pi RC$$

$$f_c = 1/(7.74) \times 10^{-4} = 1,293 \text{ Hz}$$

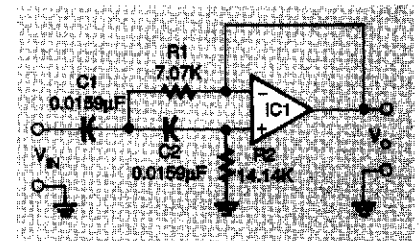

FIG. 14—SECOND-ORDER VCVS high-pass filter circuit normalized to 1-kHz by the selection of component values.

Band-pass filter

The band-pass filter is a circuit that has a passband between an upper limit and a lower limit. Frequencies above and below these limits are in the stopband. There are two basic forms of band-pass filters: Wide band pass and narrow band pass. These two types are sufficiently different that they offer different frequency response characteristics. The wide band-pass filter may have a passband that is wide enough to be called a band-pass amplifier rather than a filter and its frequency

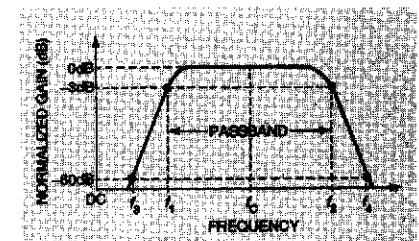

FIG. 15—TYPICAL BANDPASS curve for a wide-band filter.

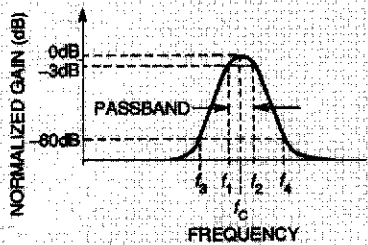

FIG. 16—TYPICAL BANDPASS curve for a narrow-band filter.

response curve is shown in Fig. 15. The narrow band-pass frequency response is shown in Fig. 16. The passband is defined as the frequency difference between the upper -3 -dB point (f_2), and the lower -3 -dB point (f_1). The bandwidth (BW) is:

$$BW = f_2 - f_1$$

The center frequency f_c (not to be confused with the cut-off frequency f_c) of the band-pass filter is usually symmetrically placed between f_1 and f_2 , or $(f_2 - f_1)/2$. If the filter is a very wide-band type, however, the center frequency is:

$$f_c = [f_1 f_2]^{1/2}$$

Band-pass filters are sometimes characterized by the figure of merit, or Q that is a factor that describes the sharpness of the filter, and is computed from:

$$Q = f_c/BW = f_c/(f_2 - f_1)$$

The Q of the filter tells us something of the passband characteristic. Wide-band filters generally have a Q less than 10, while narrow-band filters have a Q greater than 10.

The *shape factor* of the filter characterizes the slope of the roll-off curve, so is obviously related to the order of the filter. The shape factor (SF) is defined as the ratio of the -60 -dB bandwidth to the -3 -dB bandwidth:

$$SF = BW_{-60dB}/BW_{-3dB}$$

First-order band-pass filters

A wide-band first-order band-pass filter frequency response is obtained by cascading first-order, high-pass and low-pass filter circuits, as shown in Fig. 17. This arrangement overlays, or superimposes, the frequency

response characteristics of both filter stages into one stage. Figure 18 shows the filter's frequency response when cascade high- and low-pass filters are used. The low-pass filter response (solid line) is from DC to the -3 -dB point at f_2 . The high-pass filter response (dashed line) is from the highest possible frequency within the range of the circuit down to the -3 -dB point at f_1 . The passband is the intersection, or overlay, of the two sets: high and low-pass characteristics, which falls between f_1 and f_2 .

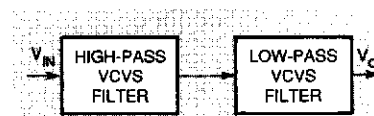

FIG. 17—BANDPASS FREQUENCY response can be achieved by cascading low-pass and high-pass AC filter stages

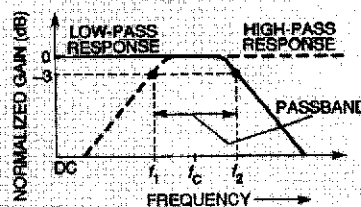

FIG. 18—THE PASSBAND is the overlapping of two separate frequency response curves.

The gain of the overall band-pass filter within the pass band is the product of the two individual gains:

$$A_{vt} = A_{vL} \times A_{vH}$$

The gain magnitude term of this form of filter is found by:

$$V_o/V_{in} = A_{vt}(f/f_1) / [(1 + (f/f_1)^2) \times (1 + (f/f_c)^2)]^{1/2}$$

where V_o is the output signal voltage; V_{in} is the input signal voltage; f is the applied frequency; f_1 is the lower -3 -dB frequency; f_2 is the upper -3 -dB frequency; and A_{vt} is the total cascade gain of the filter.

Cascading low and high-pass filter sections can be used to make wideband filters, but because of component tolerance and other problems it becomes less useful as Q increases above about 10 or so. For narrow-band filters a multiple-feedback-path

(MFP) filter circuit such as shown in Fig. 19 can be used. This filter circuit (Fig. 19) offers first-order performance and relatively narrow band-pass. The circuit will work for values of Q more than or equal to 10 and Q less than or equal to 20, and gains up to about 15. The center frequency of the MFP band-pass filter is:

$$f_c = (1/2\pi) [1/R3C1C2(1/R1 + 1/R2)]^{1/2}$$

To calculate the resistor values it is necessary to first select the passband gain (A_v) and Q . It is the general practice to select values for $C1$ and $C2$, and then calculate the required resistances for the specified values of f_c , A_v and Q . The resistor values are:

$$R1 = 1/2\pi A_v C2 f_c$$

$$R2 = 1/2\pi f_c (2Q^2 - A_v) C2$$

$$R3 = 2Q/2\pi f_c C2$$

and the gain

$$A_v = R3/R1(1 + C2/C1)$$

These equations can be simplified if the two capacitors are made equal ($C1 = C2 = C$), and assuming that Q is greater than $(A_v/2)^{1/2}$:

$$R1 = Q/2\pi f_c A_v C$$

$$R2 = Q/2\pi f_c C(2Q^2 - A_v)$$

$$R3 = 2Q/2\pi f_c C$$

$$A_v = R3/2R1$$

Example

Design an MFP band-pass filter with a gain of 5 and a Q of 15 when the center frequency is 2,200-Hz. Assume that $C1 = C2 = 0.01$ - μ F. *Solution:*

$$R1 = Q/2\pi f_c A_v C$$

$$R1 = 217,140 \text{ ohms}$$

$$R2 = Q/2\pi f_c (2Q^2 - A_v)$$

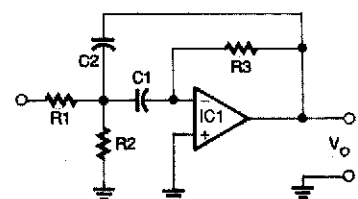

FIG. 19—MULTIPLE-FEEDBACK-PATH (MFP) filter achieves narrow-band band-pass response.

$$R2 = 15/0.062 = 240 \text{ ohms}$$

$$R3 = 2Q/2\pi f_c C$$

$$R3 = 217,140 \text{ ohms}$$

The band-pass filter is capable of being tuned using only one of the resistors. When R2 is varied, the center frequency will shift, but the bandwidth, Q, and gain will remain constant. To scale the circuit to a new center frequency (f_c) using only R2 as the change element, select a new value of R2 according to:

$$R2' = R2(f_c/f_c')$$

Notch filters

A band-reject or notch filter is used to pass all frequencies except a single frequency (or small band of frequencies). A common application for this circuit is to remove 60-Hz interference from sensitive electronic instruments. For example, the medical electrocardiograph (ECG) machine suffers 60-Hz line interference. These devices often include a switch-selectable 60-Hz notch filter to reject the interference.

Figure 20 shows a typical active-notch filter, while Fig. 21 shows the frequency-response curve for that circuit. Note that the gain is constant throughout the frequency spectrum except in the immediate vicinity of f_c . The depth of the notch is infi-

FilterMaker Software

Now available on the *Electronics Now* FTP site is FilterMaker, a software program that is an extension of this article. FilterMaker has two subsections: Passive L-C Filters and Active Op-Amp Filters. The latter offers circuit diagrams of the filter circuits covered in this article. The component values can be changed automatically for different frequencies at the touch of a screen button. Designing the circuits leaves the computations for your computer to get in the blink of an eye. You can get FilterMaker by connecting to the FTP site (<ftp://ftp.gernsback.com/pub/EN>) and downloading the file FILTERS.ZIP. After unzipping, you can install the program on computers running Windows 3.0 or better. From the Program Manager, click on FILE, then RUN, type A:SETUP and press ENTER. (This assumes that the unzipped version of FILTERS.ZIP is allocated on a disk in your A drive.) An icon will appear on the Program Manager screen that you can click to activate the program.

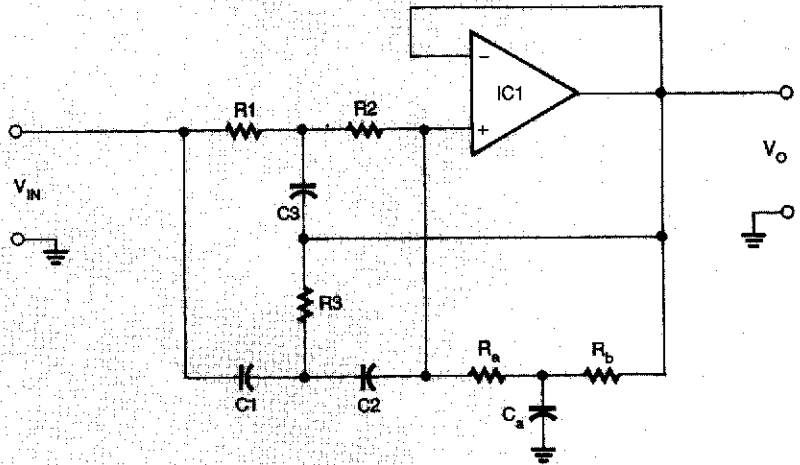

FIG. 20—A TYPICAL UNITY-GAIN, active-notch filter circuit based on the twin-tee network and an operational amplifier.

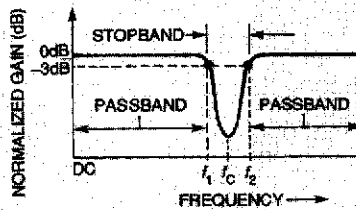

FIG. 21—FREQUENCY-RESPONSE curve for the MFP filter circuit displays a narrow frequency notch.

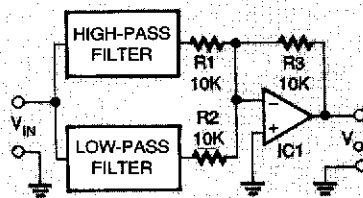

FIG. 22—BAND-REJECT FILTER is made by summing the high-pass and low-pass filter circuit elements into one circuit.

nite in theory, but in practical circuits precision matched components will offer -60 dB of suppression, while ordinary components can offer -40 to -50 dB of suppression. The resonant frequency of this notch filter is found from:

$$f_c = 1/2\pi RC$$

The gain of the circuit is unity, but the Q can be set according to the following equations:

$$Q = R_a/2R$$

or

$$Q = C/C_a$$

Bandstop filter

A bandstop filter is an example of a notch filter with a wider stopband. Just as the wide band-pass filter can be made by cascading high- and low-pass filters, the wide-band notch (or stopband) filter can be made by paralleling high- and low-pass filters. Figure 22 shows a bandstop filter in which the outputs of a high-pass filter and a low-pass filter are summed together in a two-input, unity-gain, inverting-follower amplifier circuit. The frequency-response curves of the two filter sections are superimposed to eliminate the undesired band. When designing the bandstop filter, select the -3-dB point of the high-pass filter equal to the upper end of the stopband, and the -3-dB point of the low-pass filter equal to the lower end of the stopband.

Summary

The subject of AC filter circuits is often presented as a mystical art. Indeed, the actual mathematical basis for these circuits is a bit esoteric; nonetheless, the truth is that most people can design and build practical filter circuits using only simple algebra. In fact, if you use the method of the normalized model even that math is avoided. Now, there is no reason to avoid using these very useful circuits in your own designs. Why not give it a try at your next opportunity.