

**A stepper motor, believe it or not,
makes a pretty good
shaft encoder!**



NEIL W. HECKT

SHAFT ENCODERS ARE USUALLY optoelectronic devices that produce quadrature (90-degree) signals in response to the rotation of a shaft. The phase relationship of the signals depends on the direction of rotation, and the pulse rate depends on the speed of rotation.

Shaft encoders are difficult to build, because they require mechanical construction. They are also somewhat expensive, starting at about \$30, and rarely seen on the surplus market. This article describes how to use stepper motors as replacements for optical shaft encoders. Stepper motors are commonly found on the surplus market. The small permanent-magnet (PM) motors used in floppy-disk head positioning can be purchased for as little as \$2 each.

Stepper motors are also quadrature devices. This means quadrature-related drive signals cause the shaft to rotate a precise amount. As in a shaft encoder, the phase relationship of a stepper motor's drive pulses determines its direction of rotation, and the rate of pulses determines its speed of rotation. Just as a standard electric

motor can also be used as a generator, a stepper motor can generate quadrature phased output pulses in response to mechanical rotation of its shaft.

Figure 1 is a simplified diagram of stepper motors construction. The PM stepper motor consists of a rotor and a stator. The rotor is fabricated from a cylindrical permanent magnet, or more precisely, a spool-shaped permanent magnet. Teeth, like those found on gears, are ground into the north pole of the magnet, and an identical set of teeth, offset by $\frac{1}{2}$ the tooth pitch, are ground into the south pole of the magnet. This can be seen in Fig. 1. Since the rotor in Fig. 1 has 5 teeth, the tooth pitch is $\frac{360}{5}$, or 72 degrees. In actual stepper motors, there are usually a lot more than five teeth used. Figure 2 is a photo of a disassembled 200 step/revolution stepper motor that has 50 teeth in each row.

The stator consists of an iron-core electromagnet whose poles

have the same spacing as the teeth on the gears less one tooth. Figure 1 shows that there are four poles. In a practical stepper motor there are several windings for each phase, and each winding has teeth ground on its surface to provide the effect of many more stator poles.

Stepper motor operation

Operation of the stepper motor (as a motor, and not a shaft encoder) is shown in Figs. 3 to 7. Currents are induced in the stator windings to produce magnetic poles, north (N) and south (S), as indicated on the stator pole pieces. The flux polarity of the rotor's magnetic poles are fixed by the permanent-magnet core, and each tooth possesses that flux density. The teeth are numbered to help the reader keep track of each tooth during rotation.

Figure 3 shows an arbitrary initial position (called state 0), in which the stator has a north pole at the top and a south pole

STEPPER MOTORS AS SHAFT ENCODERS

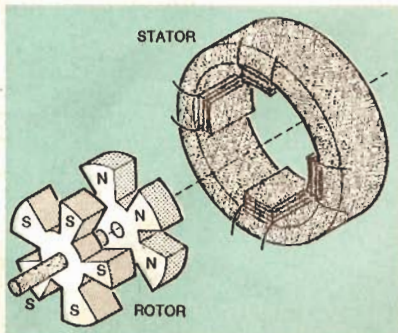

FIG. 1—A SIMPLIFIED DIAGRAM shows how stepper motors are built.



FIG. 2—THIS DISASSEMBLED 200 step/revolution stepper motor has 50 teeth in each row.

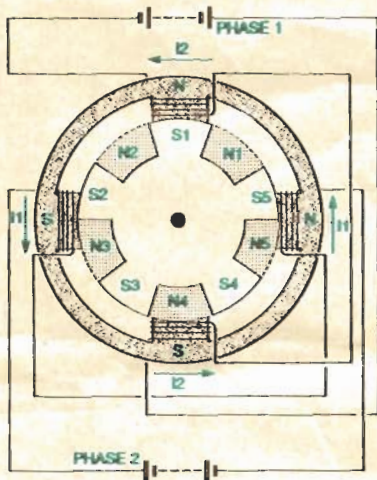

FIG. 3—THE INITIAL POSITION (state 0) results from the stator with a north pole at the top and a south pole at the bottom. They are opposite a rotor south pole (S1) at the top and north pole (N4) at the bottom.

at the bottom, and the rotor has a south pole at the top (S1) and a north pole at the bottom (N4). Because opposite magnetic poles attract, the rotor is held in this position. The left and right poles of the stator are half way between rotor teeth, so the net force is nearly neutral.

If the polarity of the current in

phase-2 is reversed, the top pole of the stator will become a south pole and the bottom pole will become north. That relationship repels the rotor flux, freeing the rotor to seek a new stable position. The nearest stable position is determined by the left and right stator poles. Because the left pole is south and the right pole is north, the nearest stable position can be reached if a rotor's north pole (N2) aligns with the stator's left south pole,

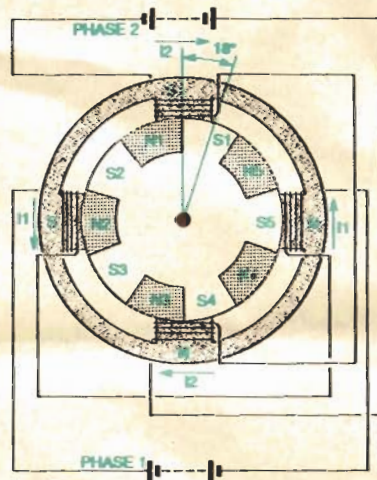

FIG. 4—STATE 1. The rotor has moved clockwise one quarter of the tooth pitch ($72/4$), or 18° .

and a rotor's south pole (S5) aligns with the stator's right north pole. This position is one-quarter tooth pitch clockwise of the initial position as shown in Fig. 4.

In Fig. 4 (the position for state 1), the rotor has moved clockwise one quarter of the tooth pitch ($72/4$), or 18° . The top and bottom stator poles are now half way between rotor poles and have a neutral force. The motor

has now found a new stable position.

In Fig. 5 (state 2), the polarity of phase 1 is reversed, causing the left stator pole to become north and the right pole to become south. The motor then finds a new stable position an additional 18° clockwise, and has now rotated a total of 36° . In Fig. 6 (state 3), the polarity of phase 2 is reversed, causing the top stator pole to become north and the bottom pole to become south. Again the motor finds a new stable position at an additional 18° clockwise, and has now rotated a total of 54° .

In Fig. 7 (state 4), the polarity of phase 1 is reversed, causing the left stator pole to become north and the right pole to become south. Again the motor finds a new stable position an additional 18° clockwise, and has now rotated a total of 72° . Because 72° is equal to one tooth pitch, the motor is again in state 0 but it is replaced one tooth clockwise. By repeating

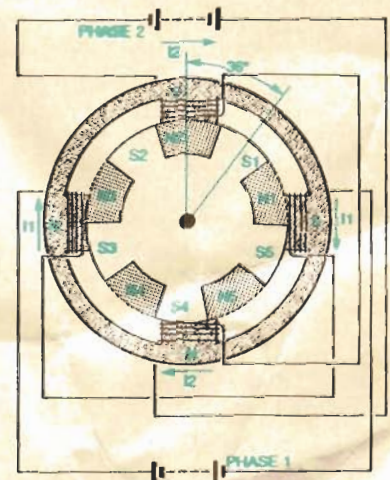

FIG. 5—STATE 2. Here the polarity of phase 1 is reversed, causing the left stator pole to become north and the right pole to become south. The motor then finds a new stable position clockwise an additional 18° , for a total of 36° .

the sequence of phase reversals in the stator, the motor will continue to rotate clockwise.

By reversing the order of phase reversals, the motor will rotate counterclockwise. The effective currents in the stator are shown in Fig. 8 for both clockwise and counterclockwise rotations. The current

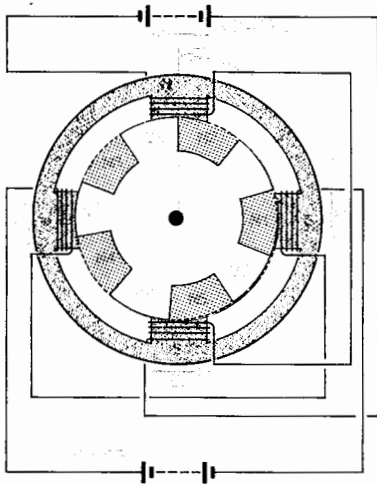

FIG. 6—STATE 3. Here the polarity of phase 2 is reversed, causing the top stator pole to become north and the bottom pole to become south. The motor has now rotated a total of 54°.

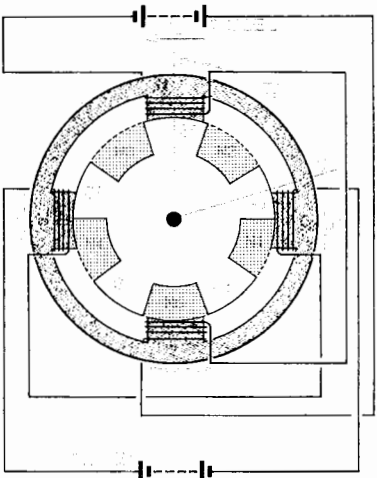

FIG. 7—STATE 4. Here the polarity of phase 1 is reversed causing the left stator pole to become north and the right pole to become south. It has now rotated a total of 72°, which is equal to one tooth pitch so the motor is again in state 0 but one tooth clockwise.

waveforms for the stepper motor are essentially square waves as shown.

Stepper generator

When a stepper motor functions as a generator, the voltage waveforms will essentially be sinewaves as shown in Fig. 9. The sinewaves constitute a "step" signal derived from phase 2 and a phase-leading (clockwise) or phase-lagging (counter clockwise) "direction" signal derived from phase 1. This permits continuous rapid rotation of the shaft.

When a stepper motor is at

rest, it has a "magnetic detent" resulting from residual magnetism in the core of the stator reacting to the flux of the rotor's permanent magnet. In single-step operation, the rotor is moved from one magnetic detent to the next. The voltage waveforms for single-step rotation are similar to those in Fig. 10.

When single stepping, the maximum output amplitude is typically 30 to 500 millivolts, and for rapid rotation it can be several volts peak-peak, although it varies with the type of motor used. As with all generators, the output voltage is a function of the strength of the magnetic flux, the rate of rotation, and the number of turns of wire on the stator. Larger motors and/or higher-voltage motors will produce greater output voltages.

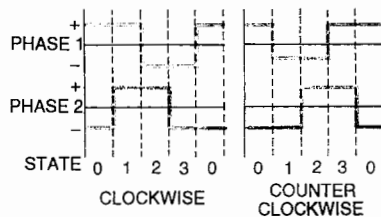

FIG. 8—STATOR CURRENTS for both clockwise and counter-clockwise rotations.

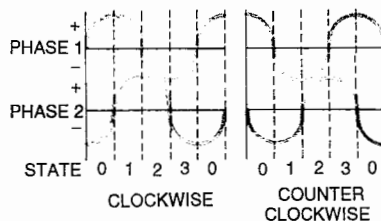

FIG. 9—WHEN A STEPPER MOTOR functions as a generator, the voltage waveforms will essentially be sinewaves with continuous rapid rotation of the shaft.

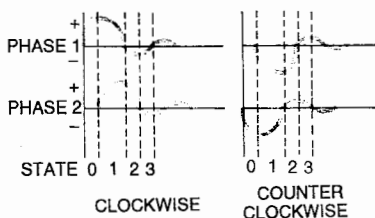

FIG. 10—THE VOLTAGE WAVEFORMS for single-step rotation are similar to these.

Stepper shaft encoder

For stepper shaft-encoder operation only the timing relationships between the pulses are important. The voltages are of interest only as a means for detecting their timing relationships and protecting the detector from excessive input voltage.

To obtain a complete set of pulses describing both rate and direction, the stepper shaft must be rotated through four of its motor positions. That is typically the distance from one magnetic detent to the next. Unfortunately the number of output-pulse sets per revolution of the shaft is one quarter the specified number of positions of the motor. A 200-step per revolution motor will therefore produce only 50 encoder output pulse sets per revolution.

To use the stepper shaft encoder, the output signals must be converted to square waves to drive logic circuits. A pair of voltage comparators, with hysteresis, convert the sinewaves to square waves (see Fig. 11). If

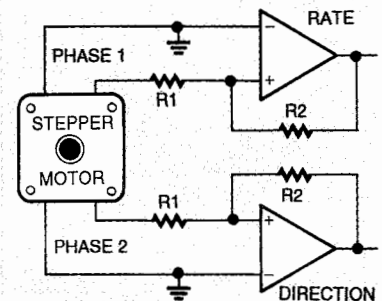

FIG. 11—TO USE A STEPPER as a shaft encoder, the output signals must be converted to square waves with a pair of voltage comparators.

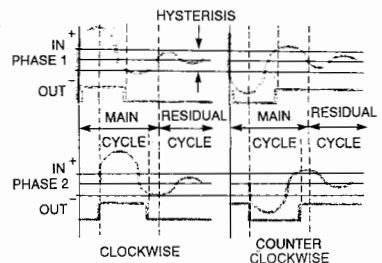

FIG. 12—COMPARATOR WAVEFORMS. The hysteresis trip points are set to less than the peak amplitude of the main cycle of the sinewave, but greater than the peak value of the residual cycle.

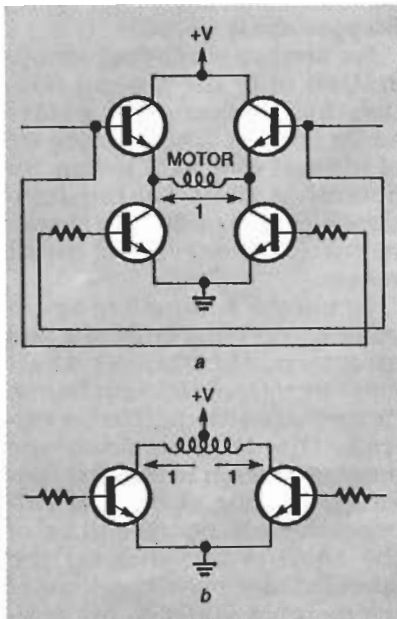

FIG. 13—BIPOLAR STEPPER MOTORS have a single winding for each phase. Unipolar units provide the bidirectional current flow when the winding is center-tapped. Shown in *a* is a bipolar drive and in *b* is a unipolar drive.

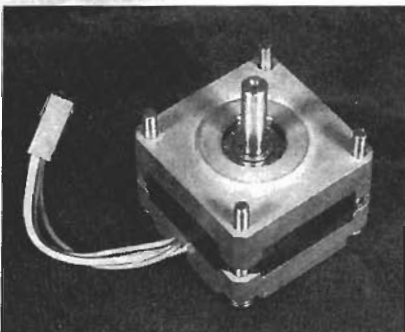

FIG. 14—THIS STEPPER provides 50 pulses per revolution.

the hysteresis is properly set, one can obtain reliable pulses even under single-step conditions.

Figure 12 shows the voltage-comparator waveforms. The hysteresis trip points are set to less than the peak amplitude of the "main" cycle of the sinewave

but greater than the peak value of the "residual" cycle. The main cycle is generated by rotating the shaft from one magnetic detent to the next. The residual cycle is obtained from the overshoot past the detent and the rocking of the shaft as it settles into the detent. The residual cycles are much lower in amplitude because the rate of rotation is much slower.

Types of stepper motors

There are basically two kinds of stepper motors: unipolar and bipolar. Bipolar motors have a single winding for each phase. Because current must flow in



FIG. 15—THIS UNIT has a step angle of 3.6°.

both directions, the bipolar motor requires a double-pole, double-throw driver such as four transistors connected in a bridge. Unipolar motors are center-tapped to provide the bidirectional current flow as shown in Fig. 13.

Most of the author's experiments were performed on four-wire bipolar stepper motors. However the unipolar motors should also work if one end and the center tap or both ends are used. The 5-wire stepper motors have a common wire for power. With those motors it is



FIG. 16—THIS STEPPER WORKS WELL and provides 25 pulses per revolution. It seems to have more magnetic detent positions than output pulses.

necessary to use the common wire as neutral and one end of each winding for the signal. For the 6-wire stepper motors, the power is not common, and the two ends of the windings can be used to double the output voltage.

Stepper motors are available with operating voltages from about 1.5 to 24 volts. For shaft-encoder use, the operating voltage is not important except that the output voltages will be higher for the higher-voltage motors. The most important specification is the step angle, or steps per revolution. Typical motors range from 15° (24 steps/revolution) to 0.9° (400 steps/revolution) with 1.8 degrees (200 steps/revolution) ratings quite common. As mentioned earlier, the number of output pulses is one quarter of the number of steps per revolution. The 200- and 400-step units that produce 50 or 100 pulses per revolution are those most suitable for shaft-encoder applications.

Figures 14-16 show several examples of stepper motors that were obtained from the list of suppliers contained in this arti-

TABLE 1—STEPPER MOTOR SPECIFICATIONS

Motor	Manufacturer	Part Number	Degrees Step	Rated Voltage	Type	Single-Step Output	Rapid-Spin Output
Fig. 14	Astrosyn	14PM-K203-01	1.8	-	Bipolar	0.5Vp-p	4.0Vp-p
Fig. 15	Airpax	LA82702-C	7.5	12	Unipolar	2.0Vp-p	12Vp-p
Fig. 16	Howard	1-9-4201	3.6	24	Unipolar	2.0Vp-p	6.0Vp-p

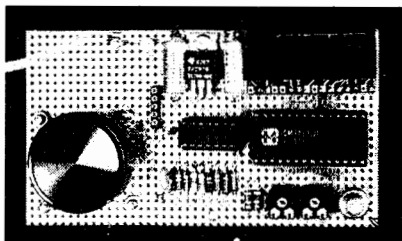

FIG. 19—PROTOTYPE TEST FIXTURE. It is important that the frame of the motor be grounded to prevent noise pickup.

olution) motor to provide 100 pulses per revolution coarse tuning and a 3.6° (100 steps/revolution) motor to provide 25 pulses per revolution fine tuning by connecting them in parallel.

The polarity of the two phases and their timing relationship depends on the application. Because there are two phases, there are four possible ways to connect the windings, one of which will meet any requirement. Most of the stepper motors have 3/16-inch diameter shafts. These cause a minor problem when fitting a knob. A piece of 1/4-inch copper or brass tubing can be used as a bushing

for a better fit. Holes opposite the set screws must be made in the bushing. Insert the tubing into the knob, tighten the set screws to mark their location, and scribe the tubing to mark the depth of the knob insert. The tubing is then removed, the holes made, and the piece cut to length.

At this point it's up to you to come up with interesting applications for using stepper motors as shaft encoders. Availability of low-cost stepper motors on the surplus market and the simplicity of the interface circuits makes their use as shaft encoders very attractive to the hobbyist. Ω

STEPPER MOTOR RESOURCE LIST

All Electronics

P.O. Box 567
Van Nuys, CA. 91408
800-826-5432

American Design Components

400 Country Ave.
Secaucus, NJ 07094
800-776-3700

American Science and Surplus

601 Lindon Pl.
Evanston, IL 60202
708-475-8440

C&H Sales

P.O. Box 5356
Pasadena, CA 91117-9988
800-325-9465

Fort Apache

31902 Hayman St.
Hayward, CA 94544
510-429-1060

Herbach & Rademan

P.O. Box 122
Bristol, PA 19007-0122
800-848-8001

MECI

340 East First St.
Dayton, OH 45402-1257
800-344-1165

Marlin P. Jones & Assoc.

P.O. Box 12685
Lake Park, FL 33403-0685
407-848-8236

R&D Electronics

1224 Prospect
Cleveland, OH 44115
216-621-1121

Digi-Key

(for the ICM7217JI)
701 Brooks Ave. S.
P.O. Box 677
Thief River Falls, MN 56701-0677
800-344-4539

